

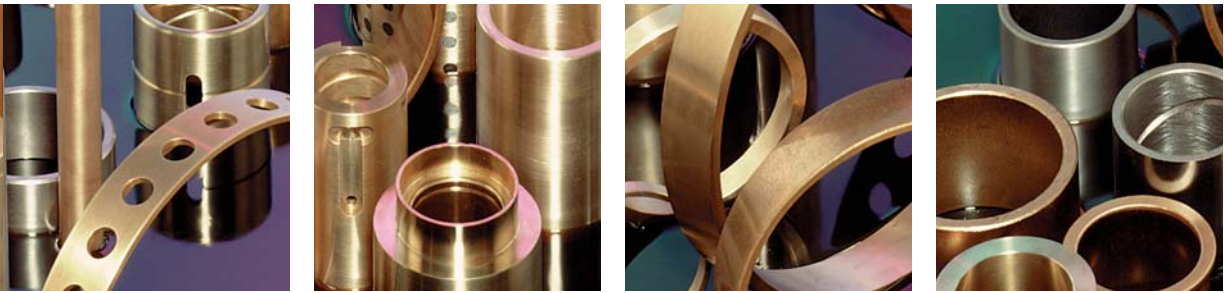

oilite[®]
BEARINGS



Oilite[®]

Super Oilite[®]

Excelite[®]

Bearings

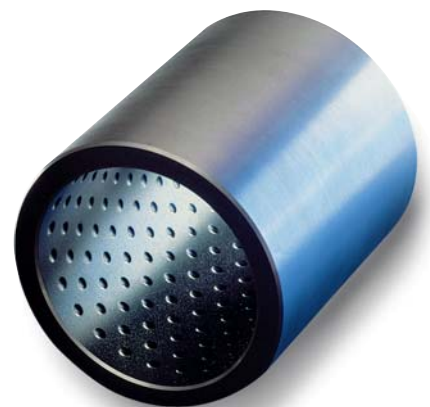

oilite®

BEARINGS

INTRODUCTION

A commitment to provide products and support that routinely goes beyond the expected. From engineering assistance to production and shipment, you will experience:

BEARING RESOURCES + BEARING SOLUTIONS
BEARING EXCELLENCE

PERIOD.

TABLE OF CONTENTS

BEARING DESIGN INFORMATION	1
OILITE BEARINGS	
Oilite <i>Plus</i> ® Sleeve Bearings	8
Oilite <i>Plus</i> ® Flange Bearings	16
Oilite <i>Plus</i> ® Thrust Bearings	19
Raw Materials	21
M Series® Metric Bearings	22
SUPER OILITE BEARINGS	
Super <i>Oilite</i> ® Bearings	25
Raw Materials	26
EXCELITE BEARINGS	
Bearing Design Information	28
Sleeve Bearings	31
ADDITIONAL MANUFACTURING CAPABILITIES	
General Information	33

The information in this catalog should be used as a guide for your consideration, investigation and verification. This information does not constitute a warranty or representation, and we assume no legal responsibility or obligation with respect thereto and the use to which such information may be put.

OILITE and EXCELITE are Registered Trademarks of Beemer Precision, Inc.



GENERAL CHARACTERISTICS and TYPICAL BEARING USES

Oilite bearing products are made by the P/M process, with close controls on materials and manufacturing to produce the premier self-lubricating bearing. With the emphasis on quality throughout the process, we produce Oilite bearings with large interconnected pores vital for the channeling of lubricants to areas between the shaft and bearing. At rest, the capillary action will recover lubricant from the surface and replenish the reservoirs. This porosity feature of Oilite is the most sought-after quality of our bearings.

THE P/M PROCESS

Fine powders are combined and blended into a mix and are compacted in a die under high pressure. The compacted parts are sintered at high temperature in a protective atmosphere belt furnace. Sintered parts are then sized to obtain the exact dimensions and close tolerances desired. The final step in the P/M process is vacuum impregnation of the bearings, or filling the pores with lubricant.



TYPICAL PROPERTIES* OILITE BEARING MATERIALS

PROPERTIES	OILITE BRONZE†	SUPER OILITE	SUPER OILITE 16
Composition — Percent			
COPPER	87.2 - 90.5	18.0 - 22.0	18.0 - 22.0
IRON	1.0 MAX	BALANCE	BALANCE
LEAD	—	—	—
GRAPHITE	0 - 0.3	—	0.6 - 1.0
TIN	9.5 - 10.5	—	—
ACID INSOLUBLES (MAX.)	—	—	—
MAGNESIUM	—	—	—
TOTAL OTHER ELEMENTS (MAX.)	1.0	2.0	2.0
BALANCE	—	—	—

Physical & Mechanical Properties

DENSITY (GM PER CU. CM.)	6.4 - 6.8	5.8 - 6.2	6.0 - 6.4
POROSITY (% OIL BY VOLUME)	19 MIN.	19 MIN.	15 MIN.
"K" STRENGTH CONSTANT	26,500	40,000	60,000
ELONGATION (% IN ONE INCH)	1	1	0.5
YIELD STRENGTH IN COMP. (PSI)**	11,000	22,000	40,000

Comparable Specifications

ASTM	B-438-05 GR 1 TYPE II	B-439-07 GR 4	B-426 GR 4 TYPE II
MILITARY	MIL-B-5687D TYPE 1 GR. 1	MIL-B-5687D TYPE 2 GR. 4	—
MPIF	CT-1000-K26	FC-2000-K30	N/A
SAE — NEW OLD	841 TYPE 1 CLASS A	863 TYPE 3	—

*Bearings may exhibit appreciable differences in properties due to size, shape, thickness, etc.
**For .001" permanent set on test specimens 1-1/4" diameter by 1" long.



ADVANTAGES and APPLICATIONS

OILITE

Self-lubricating, highly wear-resistant, ductile, conformable and corrosion resistant. Large pore structure complete with complete alpha phase bronze and twinning. Most widely used of all Oilite bearing materials.

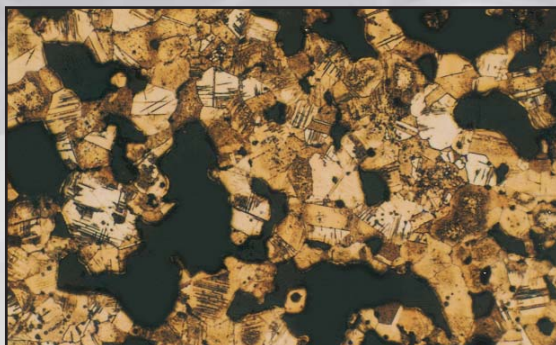

Used in appliances, business machines, cylinders, exercise apparatus, lawn and garden equipment, medical applications, material handling, packaging and printing machines, and tools.

OILITE PLUS

The advantage of Oilite *Plus* is realized in applications in which mixed-film, and boundary lubrication is exhibited. These kinds of conditions occur in well over 75% of all self-lubricating bearings applications.

Shaft oscillation or slow speed, intermittent use, pulsating or uneven loads are conditions that inhibit full-film lubrication from developing or being maintained. These applications would benefit significantly from using Oilite *Plus*.

Oilite *Plus* features a complex bearing system that greatly reduces friction. The impregnation of the bearing includes a finely dispersed PTFE in an oxidation and corrosion inhibiting turbine oil. On average a 17% reduction of friction will result in smoother and quieter operation, easier “break-in”, lower power requirements and longer life.

Applications include all equipment in the Oilite section with emphasis on agricultural and construction equipment, material handling machines, man-lifts and computer peripherals.

SUPER OILITE

Self-lubricating, harder, higher strength and generally more economical than Oilite bronze, but a lower speed rated bearing material for general application. Recommended for high load applications at low speeds.

Used in farm equipment, off-road equipment, winches, sheaves, conveyors, pulleys, etc.

SUPER OILITE 16

Self-lubricating. Similar metallurgically to Super Oilite, but heat treated to a particle hardness greater than Rc50. High compressive strength for extreme load, low speed reciprocating and oscillating applications. Requires hardened steel shaft.

Used in earth-moving equipment, cranes and hoists, railway brake rigging, presses, conveyors, etc.

LOADS AND SPEEDS

The best method for evaluating the acceptability of Oilite bearings for any given application is by using PV factor (Pressure x Surface Velocity) where:

P = the load in (psi) on the projected bearing area (Bearing ID x Length).

V = surface velocity of the shaft in feet per minute (SFM).

$$PV = \frac{W}{LD} \times \frac{\pi DN}{12} = \frac{3.14 WN}{12L}$$

W = total load on bearing (pounds)

L = bearing length (inches)

D = ID of bearing (inches)

N = shaft speed (rpm)

MATERIAL	NORMAL UPPER LIMITS FOR OILITE BEARING MATERIALS			
	PV	P(PSI) STATIC	P(PSI) DYNAMIC	V (sfm)
OILITE BRONZE	50,000	8,000	2,000	1,200
SUPER OILITE	35,000	20,000	4,000	225
SO-16	75,000	50,000	8,000	35

This information, based on our experience, is in line with accepted engineering practice and is believed to be reliable. Oilite bearings should not be used in applications that exceed operating conditions outlined, either in this catalog or in other information provided. NSK Canada Inc. assumes no obligation or liability in connection with its use or the users end product.

INSTALLATION, SIZING and SHAFTING

INSTALLATION

Bearings are usually installed by means of a shouldered arbor plug inserted in an arbor press. A chamfer in the housing bore is necessary to serve as a lead for the bearing. An unchamfered edge might shear metal from the bearing OD, seriously reducing the press fit. The OD chamfer on the lead end of the bearing acts as a pilot, and the ID chamfer in the bearing serves as a lead when the shaft is inserted. Any out-of-roundness condition is corrected when the bearing is pressed into the housing. See our interactive website at www.ca.nsk.com to calculate close-ins and press fits.

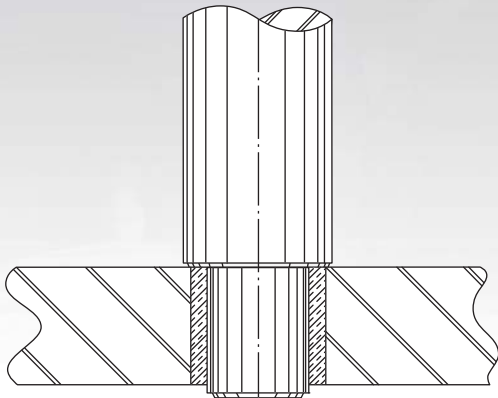

A Shouldered Arbor

SIZING

The sizing of the ID is controlled by the method selected. Several methods are commonly used:

1. No Tool Contacting ID

The bearing is pressed into the housing without the use of tools. This method allows the ID to close-in without restraint. The approximate amount of close-in is determined by the bearing material wall thickness and housing conditions.

2. Combination Insertion and Sizing Plug

The amount of close-in may be controlled by use of a combination insertion and sizing tool. The plug diameter should be approximately .0003" greater than the desired final bearing ID. The plug should fit freely in the bearing ID before installation. When the bearing is pressed into the housing, its ID will close-in on the plug. The interference between the ID and the tools is less than the interference between the OD and the housing. Upon tool withdrawal, the ID will spring back between .0002" and .0005", depending on material, bearing size and mounting conditions. The exact amount of the springback range should be determined by actual tests.

3. Roller-Type Burnisher

Roller-type burnishing tools can be used for high-production work, especially where ID tolerances are to be held within .0005".

SHAFTING

Optimum bearing operation requires a shaft of proper material, hardness and surface finish. Generally, carbon steel shafts are preferred over stainless steels. Stainless steel shafts can be problematic under certain conditions and applications. Contact our engineering department for assistance.

Shaft hardness must always be harder than the bearing (particle hardness) selected. Hardened shafts add to the load carrying ability of the bearing. Along with hardness, surface finish will improve the bearing's performance. Each application is unique and, therefore, load considerations and subsequent testing is recommended.

MACHINING

Machining Oilite presents no problems. There are a few basic procedures that should be followed to preserve the open-pore structure of the Oilite material so it will retain its full self-lubricating qualities.

Cutting tools must be sharp. For this reason tungsten carbide tooling is highly recommended since they hold a cutting edge much longer. This preserves the open-pore structure from which oil can flow freely. A dull tool will smear the pores, greatly reducing the self-lubricating qualities in the material.

Oilite bearings may be reamed provided a dead-sharp cutting tool is used. However, reaming does destroy porosity more than single point tooling.

Honing and grinding are never recommended on Oilite bearings on any surface which will become the bearing surface. These operations will smear the pores and will not allow the oil to flow freely.

LUBRICATION

Lubrication is a very important consideration, since certain conditions will necessitate the need for different oils and lubricants. These choices can greatly affect the performance and efficiency of the bearing.

Oilite is a metallic sponge with the lubricant stored in the interconnected pores of the bearing.

Capillary action holds the lubricant in the bearing and prevents it from dripping. Pressure and/or heat applied to the bearing brings the lubricant to the surface where it forms a protective oil film or optimally a hydrodynamic wedge between the bearing and the shaft.

Viscosity is the most important property of a lubricant. Viscosity is the internal friction of a fluid, or its resistance to flow. Speed and subsequent temperature build-up can cause the viscosity to become too thin to support the shaft loads, resulting in bearing failure.

OIL CHARACTERISTICS	AM 1	OILITE/PLUS (diluent only)	AM 3	
Viscosity (SUS)	@ 100° F	522	302	2420
	@ 210° F	63	64	142
Viscosity Index	95	189	90	
Flash Point	457° F	500° F	460° F	
Pour Point	+10° F	-75° F	+10° F	

NOTE: Oilite *Plus* may not be compatible with some plastics.

LUBRICANTS

Oilite bearings are vacuum impregnated with a filtered oxidation and corrosion inhibited turbine oil. There are many grades of oils and lubricants specifically developed to meet special or extreme conditions or requirements such as, high and low temperature, high loads, high speeds, low loads, low speeds, plastic compatibility or FDA compliance. Many applications combine several of these conditions.



TOLERANCES ALL FIGURES ARE IN INCHES

PLAIN AND FLANGE BEARINGS Inside and Outside Diameters

OVER	UP TO & INCL.	OILITE/OILITE PLUS	SUPER OILITE
-	1/2	+0.000	-0.001
1/2	1	+0.000	-0.001
1	1-1/2	+0.000	-0.0015
1-1/2	2-1/2	+0.000	-0.0015
2-1/2	3-1/2	+0.000	-0.002
3-1/2	4-1/2	+0.000	-0.0025
4-1/2	5-1/2	+0.000	-0.0035
5-1/2	6-1/2	+0.000	-0.004

Length

OVER	UP TO & INCL.	OILITE/OILITE PLUS	SUPER OILITE
-	1-1/2	±.005	±.010
1-1/2	3	±.0075	±.015
3	4-1/2	±.010	±.020
4-1/2	6	±.015	±.030

Flange Diameters — Based on Flange OD

OVER	UP TO & INCL.	OILITE/OILITE PLUS	SUPER OILITE
-	1-1/4	±.005	±.010
1-1/4	2-1/2	±.010	±.015
2-1/2	4	±.015	±.020
4	6	±.025	±.025

Flange Thickness — Based on Flange OD

OVER	UP TO & INCL.	OILITE/OILITE PLUS	SUPER OILITE
-	1-1/4	±.0025	±.005
1-1/4	2-1/2	±.005	±.0075

Flange Fillets, Radii — Based on Body OD

OVER	UP TO & INCL.	OILITE/OILITE PLUS	SUPER OILITE
-	1	1/32 ±.010	1/32 ±.010
1	2	3/64 ±.010	3/64 ±.010
2	2-1/2	1/16 ±.010	1/16 ±.010
2-1/2	4	3/32 ± 1/64	3/32 ± 1/64
4	6	1/8 ± 1/64	1/8 ± 1/64

Concentricity, ID with respect to OD (Maximum Total Dial Indicator Reading) — Based on ID

OVER	UP TO & INCL.	OILITE/OILITE PLUS	SUPER OILITE
-	1	.003	.003
1	1-1/2	.003	.004
1-1/2	3	.004	.005
3	4-1/2	.005	.006
4-1/2	6	.006	.007

THRUST BEARINGS Inside Diameter

OVER	UP TO & INCL.	OILITE/OILITE PLUS	SUPER OILITE
-	1-1/4	±.005	±.005
1-1/4	2-1/2	±.010	±.010
2-1/2	4	±.015	±.015
4	6	±.020	±.020

Outside Diameter

OVER	UP TO & INCL.	OILITE/OILITE PLUS	SUPER OILITE
-	1-1/2	±.010	±.010
1-1/2	3	±.015	±.015
3	4-1/2	±.020	±.020
4-1/2	6	±.025	±.025

Thickness

OVER	UP TO & INCL.	OILITE/OILITE PLUS	SUPER OILITE
1/32	1/4	±.0025	±.005

Parallelism of Faces — Based on OD

OVER	UP TO & INCL.	OILITE/OILITE PLUS	SUPER OILITE
-	1-1/2	.002	.003
1-1/2	3-1/2	.003	.004
3-1/2	6	.004	.005

CHAMFERS

Recommended Bearing Chamfers

RANGE	MINIMUM CHAMFER SIZE	TYPE
ALL THIN WALLS UP TO AND INCLUDING 1/16	ROUNDED END (1/64 "TRUE RADIUS")	A
ON WALLS GREATER THAN 1/16 UP TO 3" O.D.	1/64 X 45°	B
ON ALL BEARINGS 3" O.D. AND OVER	1/32 X 45°	B

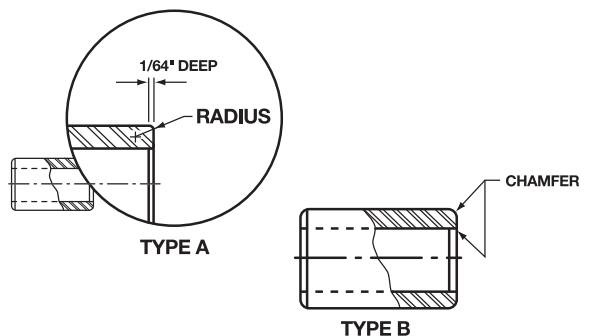

PRESS FIT VALUES / BEARING CLEARANCE / ID CLOSE-IN

PRESS FIT VALUES

Oilite and Super Oilite Bearings

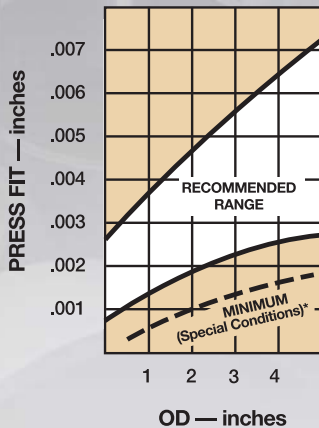

Considerable force is required to seat large bearings when press fit approaches the top of the recommended range.

*Less than normal press fit proves satisfactory:

- (1) if the bearing is long and the wall is not exceptionally thin, and
- (2) if the bearing is also carrying a moderate load exerted only in one direction.

BEARING CLEARANCE

Oilite

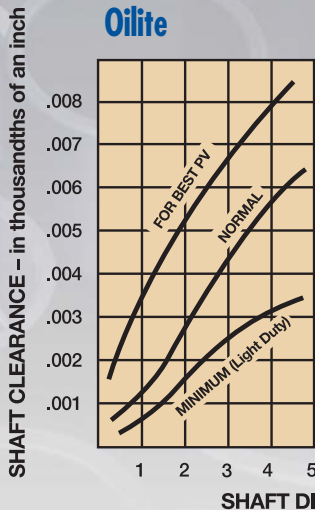

Super Oilite

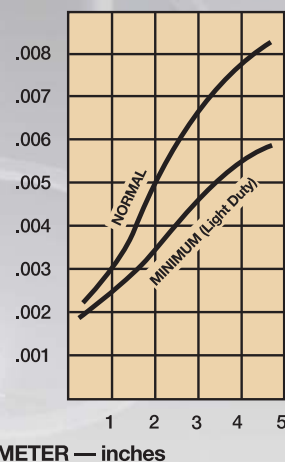

ID CLOSE-IN

As Related to Wall Thickness (Approximate Values) for Normal Press Fit

Oilite Bearings

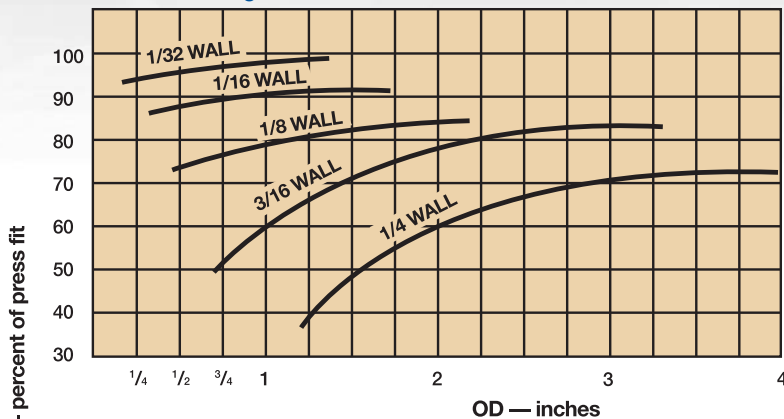

Super Oilite Bearings

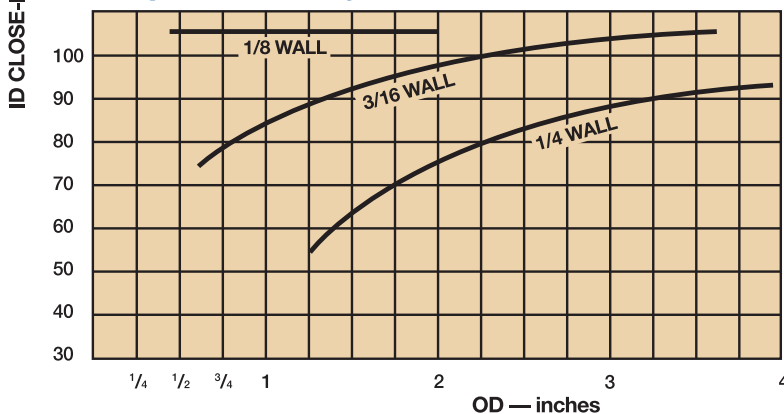



Oilite[®]/Oilite Plus[®]
BEARINGS



oilite[®]

Oilite®/Oilite Plus®

SLEEVE BEARINGS

	ID	OD	LENGTH	PART NO.
1/8 X 3/16	.125	.190	5/32	AA101-8
NOMINAL	.124	.189	1/4	AA101-2
			3/8	AA101
			1/2	AA101-1
	.1265	.1895	1/8	AA110-1
	.1255	.1885	1/4	AA110-2
			5/16	AA110-4
			1/2	AA110-3
	.127	.1905	1/4	AA102-1
	.126	.1895	1/2	AA102-2
1/8 X 7/32	.127	.222	1/4	AA223
NOMINAL	.126	.221	3/8	AA223-1
1/8 X 1/4	.127	.253	1/8	AA227-1
NOMINAL	.126	.252	1/4	AA227-2
			3/8	AA227-3
			1/2	AA227-4
	.128	.253	1/4	AA224
	.127	.252	3/8	AA224-1
1/8 X 3/8	.127	.377	1/4	AA337-2
NOMINAL	.126	.376	1/2	AA337-3
5/32 X 7/32	.156	.220	1/4	AA211
NOMINAL	.155	.219	3/8	AA211-1
5/32 X 1/4	.1565	.2525	3/8	AA238
NOMINAL	.1555	.2515		
	.159	.253	1/4	AA204-1
	.158	.252	5/16	AA204
3/16 X 1/4	.1875	.252	1/4	AA225-2
NOMINAL	.1865	.251	5/16	AA225-1
			3/8	AA225-6
			1/2	AA225-4
			5/8	AA225-3
	.1885	.252	1/4	AA226-1
	.1875	.251	3/8	AA226-2
			7/16	AA226
			1/2	AA226-3
			5/8	AA226-4
	.1895	.253	1/4	AA228-1
	.1885	.252	3/8	AA228-2
			1/2	AA228-3
			5/8	AA228-4
			3/4	AA228-6
3/16 X 5/16	.1885	.3145	3/16	AA309-9
NOMINAL	.1875	.3135	1/4	AA309
			5/16	AA309-3
			3/8	AA309-4
			7/16	AA309-8
			1/2	AA309-14
			5/8	AA309-7
			3/4	AA309-5
	.1895	.3145	3/16	AA331
	.1885	.3135	1/4	AA331-2
			3/8	AA331-3
	.1895	.3145	3/16	AP331
	.1885	.3135	1/4	AP331-2
			3/8	AP331-3
	.1895	.3155	3/16	AA311-1
	.1885	.3145	1/4	AA311-2
			5/16	AA311-3
			3/8	AA311-4
			1/2	AA311-5
			5/8	AA311-6
			3/4	AA311-7
			1	AA311-8

	ID	OD	LENGTH	PART NO.
3/16 X 3/8	.1885	.3775	1/4	AA346-1
NOMINAL	.1875	.3765	3/8	AA346-2
			1/2	AA346
	.1895	.378	1/4	AA305-1
	.1885	.377	3/8	AA305-2
			1/2	AA305-3
			5/8	AA305-4
			3/4	AA305-5
7/32 X 5/16	.219	.3145	5/16	AA318
NOMINAL	.218	.3135	3/8	AA318-1
7/32 X 7/16	.219	.440	1/2	AA410-2
NOMINAL	.218	.439	3/4	AA410-3
1/4 X 5/16	.2505	.3145	1/4	AA397-1
NOMINAL	.2495	.3135	1/2	AA397
	.2515	.3155	1/4	AA347-2
	.2505	.3145	3/8	AA347-3
			1/2	AA347-1
	.252	.3155	1/4	AA334-1
	.251	.3145	3/8	AA334-2
			1/2	AA334-3
			5/8	AA334-4
			3/4	AA334-5
	.253	.3155	1/2	AA335-4
	.252	.3145	5/8	AA335-6
			3/4	AA335-5
1/4 X 3/8	.2505	.377	1/4	AA304-35
NOMINAL	.2495	.376	5/16	AA304-9
			3/8	AA304-7
			7/16	AA304-24
			1/2	AA304-2
			9/16	AA304-5
			5/8	AA304-1
			3/4	AA304-22
			7/8	AA304-21
			1	AA304-20
			1-1/8	AA304-33
			1-1/4	AA304-11
	.252	.377	1/4	AA307
	.251	.376	5/16	AA307-1
			3/8	AA307-9
			1/2	AA307-3
			5/8	AA307-10
			3/4	AA307-11
			7/8	AA307-7
			1	AA307-2
			1-1/8	AA307-13
	.252	.378	1/4	AA340-1
	.251	.377	5/16	AA340-2
			3/8	AA340-3
			7/16	AA340-4
			1/2	AA340-5
			5/8	AA340-6
			3/4	AA340-7
			7/8	AA340-8
			1	AA340-9
			1-1/8	AA340-10
			1-1/4	AA340-11
	.253	.377	1/4	AA385-1
	.252	.376	1/2	AA385
			3/4	AA385-2
1/4 X 7/16	.251	.4395	3/8	AA430
NOMINAL	.250	.4385	1/2	AA430-1
			5/8	AA430-5
			3/4	AA430-2

	ID	OD	LENGTH	PART NO.
1/4 X 7/16	.251	.4395	7/8	AA430-6
NOMINAL	.250	.4385	1	AA430-3
(CONT.)	.252	.4395	3/8	AA412-10
	.251	.4385	1/2	AA412-7
			5/8	AA412-6
			3/4	AA412-1
			1	AA412-8
	.252	.4405	3/8	AA419-1
	.251	.4395	1/2	AA419-2
			5/8	AA419-3
			3/4	AA419-4
			7/8	AA419-5
			1	AA419-6
1/4 X 1/2	.252	.5015	5/16	AA519-4
NOMINAL	.251	.5005	1/2	AA519-1
			3/4	AA519-2
			1	AA519-3
	.252	.503	5/16	AA429-1
	.251	.502	1/2	AA429-2
			3/4	AA429-3
			1	AA429-4
			1-1/4	AA429-5
5/16 X 3/8	.3135	.377	1/4	AA306-11
NOMINAL	.3125	.376	5/16	AA306-1
			3/8	AA306-3
			1/2	AA306-7
			5/8	AA306-8
			3/4	AA306-6
	.3145	.378	1/4	AA360-1
	.3135	.377	3/8	AA360-2
			1/2	AA360-3
			5/8	AA360-4
			3/4	AA360-5
			7/8	AA360-6
			1	AA360-7
5/16 X 7/16	.3115	.441	3/8	AA403
NOMINAL	.3105	.440	1/2	AA403-2
	.3125	.440	1/4	AA407-1
	.3115	.439	5/16	AA407-10
			3/8	AA407-7
			1/2	AA407-3
			5/8	AA407-2
			3/4	AA407-4
	.3135	.4395	1/4	AA401-17
	.3125	.4385	5/16	AA401-25
			3/8	AA401-2
			7/16	AA401-20
			1/2	AA401-3
			5/8	AA401-21
			11/16	AA401-11
			3/4	AA401-5
			7/8	AA401-12
			1	AA401-1
			1-1/8	AA401
			1-1/4	AA401-6
			1-3/8	AA401-8
	.3135	.4395	1/4	AP401-17
	.3125	.4385	3/8	AP401-2
			1/2	AP401-3
			5/8	AP401-21
			3/4	AP401-5
	.3145	.440	1/4	AA418-1
	.3135	.439	3/8	AA418-2
			1/2	AA418-3
			5/8	AA418-4

Note: The "AP-" prefix indicates Oilite Plus. All sizes can be special ordered in Oilite Plus.

Oilite®/Oilite Plus®

SLEEVE BEARINGS

	ID	OD	LENGTH	PART NO.	
5/16X7/16 NOMINAL (CONT.)	.3145	.4405	1/4	AA470-1	
	.3135	.4395	5/16	AA470-2	
			3/8	AA470-3	
			1/2	AA470-4	
			5/8	AA470-5	
			3/4	AA470-6	
			7/8	AA470-7	
			1	AA470-8	
			1-1/8	AA470-9	
			1-1/4	AA470-10	
		.3155	.4395	1/4	AA417-7
		.3145	.4385	1/2	AA417
			3/4	AA417-3	
	5/16X1/2 NOMINAL	.3125	.503	3/8	AA520-8
		.3115	.502	1/2	AA520-3
			5/8	AA520-4	
			3/4	AA520-1	
			7/8	AA520-2	
			1	AA520-5	
.314		.503	1/4	AA506-16	
.313		.502	3/8	AA506-2	
			1/2	AA506-7	
			9/16	AA506-1	
			5/8	AA506-3	
			3/4	AA506-8	
			1	AA506-9	
		.3145	.503	3/8	AA560-1
		.3135	.502	1/2	AA560-2
		5/8	AA560-3		
		3/4	AA560-4		
		7/8	AA560-5		
		1	AA560-6		
		1-1/4	AA560-7		
		1-1/2	AA560-8		
3/8X7/16 NOMINAL	.3765	.440	1/4	AA432-4	
	.3755	.439	3/8	AA432-2	
			1/2	AA432-1	
			3/4	AA432-3	
	.377	.4405	1/2	AA431-1	
	.376	.4395	5/8	AA431-2	
			3/4	AA431-3	
			1	AA431-4	
	3/8X1/2 NOMINAL	.375	.503	1/4	AA521-4
		.374	.502	3/8	AA521-9
			7/16	AA521-8	
			1/2	AA521-1	
			5/8	AA521-10	
			3/4	AA521	
			7/8	AA521-2	
			1	AA521-11	
			1-1/4	AA521-12	
.3765		.503	3/16	AA507-12	
.3755		.502	1/4	AA507-19	
			5/16	AA507-13	
		3/8	AA507-11		
		7/16	AA507-4		
		1/2	AA507-10		
		5/8	AA507-5		
		3/4	AA507-2		
		7/8	AA507-3		
		1	AA507-23		
		1-1/8	AA507-17		
.377	.503	1/4	AA508-1		
.376	.502	5/16	AA508-2		

	ID	OD	LENGTH	PART NO.
3/8X1/2 NOMINAL (CONT.)	.377	.503	3/8	AA508-3
	.376	.502	7/16	AA508-4
			1/2	AA508-5
			5/8	AA508-6
			3/4	AA508-7
			7/8	AA508-8
			1	AA508-9
			1-1/8	AA508-10
			1-1/4	AA508-11
	.378	.5025	1/4	AA502-5
	.377	.5015	3/8	AA502-4
			1/2	AA502
			5/8	AA502-3
			3/4	AA502-1
			1	AA502-2
.378	.5025	1/4	AP502-5	
.377	.5015	3/8	AP502-4	
		1/2	AP502	
		5/8	AP502-3	
		3/4	AP502-1	
		1	AP502-2	
3/8X9/16 NOMINAL	.3765	.5655	3/8	AA516-5
	.3755	.5645	1/2	AA516-6
			9/16	AA516-3
			11/16	AA516
			3/4	AA516-10
			1	AA516-8
			1-1/4	AA516-2
	.377	.5655	3/8	AA572-1
	.376	.5645	1/2	AA572-2
			5/8	AA572-3
		3/4	AA572-4	
		7/8	AA572-5	
		1	AA572-6	
		1-1/4	AA572-7	
3/8X5/8 NOMINAL	.376	.627	3/8	AA630-8
	.375	.626	7/16	AA630-16
			1/2	AA630-11
			5/8	AA630-6
			3/4	AA630-12
			7/8	AA630
			1	AA630-7
			1-1/8	AA630-1
			1-1/4	AA630-2
	.377	.628	3/8	AA624-1
	.376	.627	1/2	AA624-2
			5/8	AA624-3
		3/4	AA624-4	
		7/8	AA624-5	
		1	AA624-6	
		1-1/4	AA624-7	
3/8X11/16 NOMINAL	.3765	.689	3/4	AA615
	.3755	.688	1-1/2	AA615-2
3/8X3/4 NOMINAL	.377	.753	3/8	AA707-5
	.376	.752	1/2	AA707-2
			3/4	AA707-3
			1	AA707
			1-1/4	AA707-4
7/16X9/16 NOMINAL	.439	.565	5/16	AA515-1
	.438	.564	3/8	AA515-21
			1/2	AA515-2
			5/8	AA515-3
			3/4	AA515
			13/16	AA515-12
			15/16	AA515-6
			1	AA515-8

	ID	OD	LENGTH	PART NO.
7/16X9/16 NOMINAL (CONT.)	.4395	.5655	3/8	AA514-1
	.4385	.5645	1/2	AA514-2
			5/8	AA514-3
			3/4	AA514-4
			1	AA514-5
			1-1/4	AA514-6
7/16X5/8 NOMINAL	.439	.627	3/8	AA627-5
	.438	.626	7/16	AA627-13
			1/2	AA627-8
			5/8	AA627-3
			3/4	AA627
			1	AA627-4
			1-1/4	AA627-1
			1-1/2	AA627-7
	.4395	.628	3/8	AA626-1
	.4385	.627	1/2	AA626-2
		5/8	AA626-3	
		3/4	AA626-4	
		7/8	AA626-5	
		1	AA626-6	
		1-1/4	AA626-7	
		1-1/2	AA626-8	
7/16X11/16 NOMINAL	.4395	.6905	1/2	AA604-1
	.4385	.6895	1	AA604-2
			1-1/2	AA604-3
1/2X5/8 NOMINAL	.5015	.628	5/16	AA628-21
	.5005	.627	3/8	AA628-7
			7/16	AA628-8
			1/2	AA628-10
			9/16	AA628-3
			5/8	AA628-25
			11/16	AA628-12
			3/4	AA628-6
			7/8	AA628-20
			1	AA628
			1-1/4	AA628-11
			1-1/2	AA628-5
	.5015	.628	5/16	AP628-21
	.5005	.627	3/8	AP628-7
			7/16	AP628-8
		1/2	AP628-10	
		5/8	AP628-25	
		3/4	AP628-6	
		1	AP628	
.502	.628	3/8	AA632-1	
.501	.627	7/16	AA632-7	
		1/2	AA632-2	
		9/16	AA632-8	
		5/8	AA632-3	
		11/16	AA632-9	
		3/4	AA632-4	
		7/8	AA632-5	
		1	AA632-6	
		1-1/8	AA632-10	
		1-1/4	AA632-11	
		1-1/2	AA632-12	
.5025	.629	1/2	AA607-1	
.5015	.628	5/8	AA607-2	
		3/4	AA607-5	
		1	AA607-3	
		1-1/4	AA607-6	
.504	.6275	1/2	AA634-4	
.503	.6265	1	AA634-5	

Note: The "AP-" prefix indicates Oilite Plus. All sizes can be special ordered in Oilite Plus.

Oilite®/Oilite Plus®

SLEEVE BEARINGS

	ID	OD	LENGTH	PART NO.
1/2X11/16	.5015	.690	3/8	AA650-4
NOMINAL	.5005	.689	1/2	AA650-1
			9/16	AA650-6
			5/8	AA650-9
			3/4	AA650
			7/8	AA650-7
			1	AA650-2
			1-1/8	AA650-5
			1-1/4	AA650-12
			1-1/2	AA650-3
	.502	.6905	3/8	AA652-1
	.501	.6895	1/2	AA652-2
			5/8	AA652-3
			3/4	AA652-4
			7/8	AA652-5
			1	AA652-6
			1-1/8	AA652-7
			1-1/4	AA652-8
			1-1/2	AA652-9
	.5025	.689	3/8	AA631-13
	.5015	.688	3/4	AA631
			1-1/4	AA631-1
	.504	.690	1/4	AA618-16
	.503	.689	1/2	AA618-1
			9/16	AA618-13
			5/8	AA618-12
			3/4	AA618-11
			7/8	AA618-8
			1	AA618-6
			1-1/8	AA618-2
			1-3/8	AA618-5
1/2X3/4	.5005	.752	1/2	AA742-1
NOMINAL	.4995	.751	3/4	AA742-2
			1	AA742
			1-1/8	AA742-4
			1-1/4	AA742-3
	.5015	.752	1/2	AA753
	.5005	.751	9/16	AA753-1
			3/4	AA753-5
			1	AA753-2
			1-1/2	AA753-4
	.502	.753	3/8	AA751
	.501	.752	1/2	AA751-1
			5/8	AA751-2
			3/4	AA751-3
			7/8	AA751-4
			1	AA751-5
			1-1/8	AA751-6
			1-1/4	AA751-7
			1-1/2	AA751-8
			1-3/4	AA751-9
			2	AA751-10
	.5025	.753	1/2	AA744-5
	.5015	.752	5/8	AA744-9
			3/4	AA744-4
			7/8	AA744-10
			1	AA744-3
			1-1/4	AA744
			1-1/2	AA744-1
			1-3/4	AA744-2
	.5025	.753	1/2	AP744-5
	.5015	.752	5/8	AP744-9
			3/4	AP744-4
			7/8	AP744-10
			1	AP744-3

	ID	OD	LENGTH	PART NO.
1/2X13/16	.501	.815	3/4	AA886-3
NOMINAL	.500	.814	1	AA886-1
			1-1/2	AA886-4
	.502	.8165	1/2	AA887-14
	.501	.8155	3/4	AA887-2
			1	AA887-3
			1-1/2	AA887-4
1/2X7/8	.502	.879	1/2	AA840-1
NOMINAL	.501	.878	5/8	AA840-2
			3/4	AA840-3
			7/8	AA840-4
			1	AA840-5
			1-1/4	AA840-6
			1-1/2	AA840-7
	.503	.879	1/2	AA842-7
	.502	.878	3/4	AA842-4
			1	AA842-3
			1-1/4	AA842-2
			1-1/2	AA842
1/2X1	.502	1.004	3/4	AA816-1
NOMINAL	.501	1.003	1	AA816-2
			1-1/2	AA816-3
			2	AA816-4
9/16X11/16	.5635	.691	7/16	AA620-3
NOMINAL	.5625	.690	1/2	AA620-7
			5/8	AA620-8
			3/4	AA620-1
			1	AA620
			1-1/4	AA620-5
	.5645	.6905	1/2	AA621-1
	.5635	.6895	5/8	AA621-2
			3/4	AA621-3
			1	AA621-4
			1-1/4	AA621-5
			1-1/2	AA621-6
9/16X3/4	.5635	.7535	1/2	AA711-7
NOMINAL	.5625	.7525	5/8	AA711-6
			3/4	AA711-1
			1	AA711-3
			1-1/4	AA711-5
			1-3/8	AA711
			1-1/2	AA711-2
	.5645	.753	1/2	AA712-1
	.5635	.752	3/4	AA712-2
			1	AA712-3
			1-1/4	AA712-4
	.566	.753	1/2	AA709-7
	.565	.752	3/4	AA709-8
			1	AA709
			1-1/4	AA709-5
			1-1/2	AA709-6
9/16X13/16	.563	.815	3/4	AA807-3
NOMINAL	.562	.814	1	AA807-2
			1-1/4	AA807-4
9/16X7/8	.567	.877	1	AA863-3
NOMINAL	.566	.876	1-3/8	AA863
5/8X3/4	.626	.753	1/2	AA724-8
NOMINAL	.625	.752	7/8	AA724-2
			1	AA724-3
			1-1/8	AA724
			1-1/4	AA724-5

	ID	OD	LENGTH	PART NO.
5/8X3/4	.627	.752	1/2	AA741
NOMINAL	.626	.751	5/8	AA741-1
(CONT.)			3/4	AA741-4
	.627	.753	3/8	AA710-13
	.626	.752	1/2	AA710-27
			5/8	AA710-19
			3/4	AA710-6
			7/8	AA710-16
			1	AA710-3
			1-1/8	AA710-8
			1-1/4	AA710-5
			1-1/2	AA710-4
	.627	.753	1/2	AP710-27
	.626	.752	5/8	AP710-19
			3/4	AP710-6
			7/8	AP710-16
			1	AP710-3
	.628	.753	1/2	AA713-1
	.627	.752	5/8	AA713-2
			3/4	AA713-3
			7/8	AA713-4
			1	AA713-5
5/8X13/16	.625	.815	1/2	AA810-4
NOMINAL	.624	.814	5/8	AA810-2
			3/4	AA810-10
			7/8	AA810-1
			1	AA810-7
			1-1/4	AA810-11
			1-3/8	AA810
			1-1/2	AA810-12
	.627	.815	3/4	AA811-7
	.626	.814	1	AA811-6
			1-1/4	AA811-2
			1-3/8	AA811-5
			1-1/2	AA811-3
			1-3/4	AA811-1
	.627	.8165	1/2	AA813-1
	.626	.8155	5/8	AA813-2
			3/4	AA813-3
			7/8	AA813-4
			1	AA813-5
			1-1/4	AA813-6
			1-1/2	AA813-7
			1-3/4	AA813-8
	.628	.8155	5/8	AA814-3
	.627	.8145	3/4	AA814-2
			1	AA814
			1-1/4	AA814-5
5/8X7/8	.625	.877	1/2	AA880-4
NOMINAL	.624	.876	3/4	AA880-2
			1	AA880-1
			1-1/2	AA880
	.627	.878	1/2	AA832-11
	.626	.876	5/8	AA832-12
			3/4	AA832-6
			7/8	AA832-8
			1	AA832-1
	.627	.878	1-1/8	AA832-13
	.626	.876	1-1/4	AA832-4
			1-3/8	AA832-2
			1-1/2	AA832-5
			1-5/8	AA832-9
			2	AA832-18
	.627	.878	1/2	AP832-11
	.626	.877	5/8	AP832-12

Note: The "AP-" prefix indicates Oilite Plus. All sizes can be special ordered in Oilite Plus.

Oilite®/Oilite Plus®

SLEEVE BEARINGS

	ID	OD	LENGTH	PART NO.
5/8X7/8	.627	.878	3/4	AP832-6
NOMINAL	.626	.877	7/8	AP832-8
(CONT.)			1	AP832-1
	.627	.879	1/2	AA883-1
	.626	.878	5/8	AA883-2
			3/4	AA883-3
			7/8	AA883-4
			1	AA883-5
			1-1/8	AA883-6
			1-1/4	AA883-7
			1-1/2	AA883-8
			1-3/4	AA883-9
			2	AA883-10
	.628	.878	1/2	AA881-1
	.627	.877	5/8	AA881-2
			3/4	AA881-3
			7/8	AA881-4
			1	AA881-5
5/8X15/16	.628	.940	5/8	AA946-4
NOMINAL	.627	.939	3/4	AA946-2
			1	AA946-1
5/8X1	.627	1.004	1/2	AA1014-1
NOMINAL	.626	1.003	5/8	AA1014-2
			3/4	AA1014-3
			1	AA1014-4
			1-1/4	AA1014-5
			1-1/2	AA1014-6
			1-3/4	AA1014-7
			2	AA1014-8
	.628	1.0035	3/4	AA1011-12
	.627	1.0025	7/8	AA1011-5
			1	AA1011-3
			1-1/8	AA1011-4
			1-1/4	AA1011-1
			1-3/8	AA1011-13
			1-1/2	AA1011
11/16X13/16	.6885	.815	1	AA812-1
NOMINAL	.6875	.814	1-1/4	AA812
11/16X7/8	.6895	.879	3/4	AA857-1
NOMINAL	.6885	.878	1	AA857-2
			1-1/4	AA857-3
			1-1/2	AA857-4
			1-3/4	AA857-5
			2	AA857-6
	.690	.878	1/2	AA851-2
	.689	.877	3/4	AA851-7
			1	AA851-8
			1-1/8	AA851-6
			1-1/4	AA851-1
11/16X15/16	.689	.941	1	AA939-3
NOMINAL	.688	.940	1-1/4	AA939-2
			1-1/2	AA939-4
3/4X7/8	.751	.878	1/2	AA838-14
NOMINAL	.750	.877	9/16	AA838-9
			5/8	AA838-25
			3/4	AA838-16
			7/8	AA838-6
			1	AA838-7
			1-1/8	AA838-13
			1-1/4	AA838-5
			1-3/8	AA838-15
			1-1/2	AA838-4
			1-5/8	AA838-8

	ID	OD	LENGTH	PART NO.
3/4X7/8	.752	.878	3/4	AA885
NOMINAL	.751	.877	1	AA885-3
(CONT.)			1-1/4	AA885-4
	.752	.879	1/2	AA884-1
	.751	.878	9/16	AA884-2
			5/8	AA884-3
			3/4	AA884-4
			7/8	AA884-5
			1	AA884-6
			1-1/8	AA884-7
			1-1/4	AA884-8
			1-1/2	AA884-9
			1-5/8	AA884-10
	.753	.878	1/2	AA839-14
	.752	.877	5/8	AA839-1
			11/16	AA839-3
			3/4	AA839-6
			1	AA839-13
			1-1/8	AA839-2
			1-1/4	AA839-4
			1-1/2	AA839-7
	.753	.878	5/8	AP839-1
	.752	.877	3/4	AP839-6
			1	AP839-13
3/4X15/16	.7515	.940	3/4	AA921-5
NOMINAL	.7505	.939	1	AA921-4
			1-1/8	AA921-2
			1-1/4	AA921-3
			1-1/2	AA921-1
			1-3/4	AA921
			2	AA921-6
	.752	.9415	1/2	AA932-1
	.751	.9105	5/8	AA932-2
			3/4	AA932-3
			7/8	AA932-4
			1	AA932-5
			1-1/8	AA932-6
			1-1/4	AA932-7
			1-1/2	AA932-8
			1-3/4	AA932-9
			2	AA932-10
	.752	.942	1	AA912
	.751	.941	1-1/4	AA912-4
			1-3/8	AA912-1
			1-1/2	AA912-6
			1-5/8	AA912-2
			1-3/4	AA912-7
3/4X1	.7505	1.0025	3/4	AA1005-5
NOMINAL	.7495	1.0015	1	AA1005-7
			1-1/8	AA1005-3
			1-1/4	AA1005-2
			1-1/2	AA1005-4
	.752	1.0025	3/8	AA1049-18
	.751	1.0015	1/2	AA1049-14
			5/8	AA1049-7
			3/4	AA1049-1
			7/8	AA1049-2
			1	AA1049-3
			1-1/8	AA1049-16
			1-1/4	AA1049
			1-3/8	AA1049-17
			1-1/2	AA1049-4
			1-3/4	AA1049-9
			2	AA1049-5

	ID	OD	LENGTH	PART NO.
3/4X1	.752	1.0025	2-1/4	AA1049-11
NOMINAL	.751	1.0015	2-1/4	AA1049-12
(CONT.)			2-1/2	AA1049-6
	.752	1.004	1/2	AA1044-1
	.751	1.003	5/8	AA1044-2
			3/4	AA1044-3
			7/8	AA1044-4
			1	AA1044-5
			1-1/8	AA1044-6
			1-1/4	AA1044-7
			1-1/2	AA1044-8
			1-3/4	AA1044-9
			2	AA1044-10
			2-1/2	AA1044-11
	.753	1.003	1/2	AA1043-1
	.752	1.002	5/8	AA1043-2
			3/4	AA1043-6
			7/8	AA1043-8
			1	AA1043-9
			1-1/4	AA1043
			1-1/2	AA1043-4
			1-3/4	AA1043-10
	.753	1.003	1/2	API043-1
	.752	1.002	5/8	API043-2
			3/4	API043-6
			1	API043-9
			1-1/4	API043
3/4X1-1/16	.751	1.0645	1	AA1039
NOMINAL	.750	1.0635	1-1/4	AA1039-2
3/4X1-1/8	.750	1.129	3/4	AA1130-3
NOMINAL	.749	1.128	1-1/4	AA1130
	.752	1.129	1/2	AA1131-1
	.751	1.128	3/4	AA1131-2
			1	AA1131-3
			1-1/4	AA1131-4
			1-1/2	AA1131-5
			1-3/4	AA1131-6
			2	AA1131-7
	.753	1.128	3/4	AA1106-2
	.752	1.127	1	AA1106-4
			1-1/4	AA1106-3
			1-3/8	AA1106-13
			1-1/2	AA1106
			1-3/4	AA1106-1
3/4X1-1/4	.752	1.254	3/4	AA1258-1
NOMINAL	.751	1.253	1	AA1258-2
			1-1/4	AA1258-3
			1-1/2	AA1258-4
	.753	1.253	1	AA1257
	.752	1.252	1-1/4	AA1257-1
			1-1/2	AA1257-2
			3	AA1257-3
13/16X1	.8135	1.003	1	AA1056-5
NOMINAL	.8125	1.002	1-1/4	AA1056-3
			1-3/4	AA1056
	.8145	1.003	7/8	AA1041-2
	.8135	1.002	1	AA1041-5
			1-1/4	AA1041-6
7/8X1	.876	1.003	3/8	AA1008-11
NOMINAL	.875	1.002	7/16	AA1008-14
			1/2	AA1008-9
			5/8	AA1008-13
			3/4	AA1008-5
			1	AA1008-6

Note: The "AP-" prefix indicates Oilite Plus. All sizes can be special ordered in Oilite Plus.

Oilite®/Oilite Plus®

SLEEVE BEARINGS

	ID	OD	LENGTH	PART NO.
7/8X1	.876	1.003	1-1/4	AA1008-1
NOMINAL	.875	1.002	1-1/2	AA1008-2
(CONT.)			1-3/4	AA1008-10
	.877	1.003	1/2	AA1009-1
	.876	1.002	5/8	AA1009-5
			3/4	AA1009-8
			1	AA1009-3
			1-1/8	AA1009
			1-1/4	AA1009-2
	.877	1.003	1/2	AP1009-1
	.876	1.002	5/8	AP1009-5
			3/4	AP1009-8
			1	AP1009-3
	.877	1.004	5/8	AA1010-1
	.876	1.003	3/4	AA1010-2
			7/8	AA1010-3
			1	AA1010-4
			1-1/4	AA1010-5
			1-1/2	AA1010-6
			1-3/4	AA1010-7
	.878	1.003	1/2	AA1007-1
	.877	1.002	3/4	AA1007-2
			7/8	AA1007-3
			1	AA1007-4
7/8X1-1/16	.877	1.065	3/4	AA1051-3
NOMINAL	.876	1.064	1	AA1051-4
			1-1/4	AA1051-2
7/8X1-1/8	.876	1.128	3/4	AA1108
NOMINAL	.875	1.127	7/8	AA1108-15
			1	AA1108-1
			1-1/8	AA1108-2
			1-1/4	AA1108-7
			1-3/8	AA1108-16
			1-1/2	AA1108-12
			1-3/4	AA1108-10
			2	AA1108-3
			2-1/4	AA1108-11
			2-1/2	AA1108-5
			2-3/4	AA1108-6
	.877	1.129	3/4	AA1109-1
	.876	1.128	7/8	AA1109-2
			1	AA1109-3
			1-1/8	AA1109-4
			1-1/4	AA1109-5
			1-3/8	AA1109-6
			1-1/2	AA1109-7
			1-3/4	AA1109-8
			2	AA1109-9
			2-1/2	AA1109-10
	.878	1.1275	3/4	AA1104-1
	.877	1.1265	7/8	AA1104-6
			1	AA1104-2
			1-1/4	AA1104-5
			1-3/8	AA1104-4
			1-1/2	AA1104-3
	.878	1.1275	3/4	AP1104-1
	.877	1.1265	7/8	AP1104-6
			1	AP1104-2
			1-1/4	AP1104-5
7/8X1-1/4	.877	1.252	1	AA1203-3
NOMINAL	.876	1.251	1-1/4	AA1203
			1-1/2	AA1203-1
	.877	1.254	3/4	AA1243-1
	.876	1.253	1	AA1243-2

	ID	OD	LENGTH	PART NO.
7/8X1-1/4	.877	1.252	1-1/4	AA1243-3
NOMINAL	.876	1.251	1-1/2	AA1243-4
(CONT.)			2	AA1243-5
	.878	1.253	3/4	AA1242-2
	.877	1.252	1	AA1242-3
			1-3/8	AA1242
15/16X1-1/16	.940	1.065	3/4	AA1087-1
NOMINAL	.939	1.064	1-1/4	AA1087
15/16X1-3/16	.939	1.1895	7/8	AA1118-6
NOMINAL	.938	1.1885	1	AA1118-4
			1-1/4	AA1118-2
			1-1/2	AA1118-5
	.9395	1.1915	3/4	AA1117-1
	.9385	1.1905	1	AA1117-2
			1-1/4	AA1117-3
			1-1/2	AA1117-4
			2	AA1117-5
15/16X1-1/4	.9375	1.253	1	AA1206-1
NOMINAL	.9365	1.252	1-1/4	AA1206-4
			1-1/2	AA1206-2
	.9395	1.254	3/4	AA1207-1
	.9385	1.253	1	AA1207-2
			1-1/4	AA1207-3
			1-1/2	AA1207-4
			1-3/4	AA1207-5
			2	AA1207-6
	.940	1.254	1-1/2	AA1216-3
	.939	1.253	2	AA1216
1X1-1/8	1.001	1.128	1/2	AA1110-8
NOMINAL	1.000	1.127	3/4	AA1110-10
			13/16	AA1110-2
			1	AA1110-1
			1-1/4	AA1110-3
			1-3/8	AA1110-12
			1-1/2	AA1110
	1.003	1.129	3/4	AA1157-1
	1.002	1.128	7/8	AA1157-2
			1	AA1157-3
			1-1/4	AA1157-4
			1-1/2	AA1157-6
			1-3/4	AA1157-7
			2	AA1157-8
	1.0035	1.128	3/4	AA1156
	1.0025	1.127	7/8	AA1156-4
			1-1/4	AA1156-3
			1-1/2	AA1156-1
1X1-3/16	1.002	1.1895	3/4	AA1154-2
NOMINAL	1.001	1.1885	1	AA1154-1
			1-1/2	AA1154-3
			2	AA1154
	1.003	1.1915	3/4	AA1159-1
	1.002	1.1905	1	AA1159-2
			1-1/4	AA1159-3
			1-1/2	AA1159-4
			1-3/4	AA1159-5
			2	AA1159-6
1X1-1/4	1.001	1.252	1/2	AA1212-7
NOMINAL	1.000	1.251	3/4	AA1212-6
			1	AA1212-2
			1-1/4	AA1212-16
			1-1/2	AA1212-11
			1-3/4	AA1212-4

	ID	OD	LENGTH	PART NO.
1X1-1/4	1.001	1.252	2	AA1212-3
NOMINAL	1.000	1.251	2-1/4	AA1212-5
(CONT.)			2-1/2	AA1212
			2-7/8	AA1212-8
			3	AA1212-14
	1.002	1.252	1/2	AA1213-4
	1.001	1.251	3/4	AA1213-5
			7/8	AA1213-6
			1	AA1213-3
			1-1/8	AA1213-10
			1-1/4	AA1213-12
			1-1/2	AA1213-1
			1-3/4	AA1213-2
			2	AA1213
			2-1/2	AA1213-14
			3	AA1213-15
	1.003	1.253	1/2	AA1232-1
	1.002	1.252	5/8	AA1232-10
			3/4	AA1232-6
			7/8	AA1232-9
			1	AA1232
			1-1/8	AA1232-2
			1-1/4	AA1232-3
			1-1/2	AA1232-7
			1-3/4	AA1232-8
			2	AA1232-4
			2-1/2	AA1232-5
	1.003	1.253	1/2	AP1232-1
	1.002	1.252	3/4	AP1232-6
			1	AP1232
			1-1/4	AP1232-3
			1-1/2	AP1232-7
	1.003	1.254	1/2	AA1233-1
	1.002	1.253	3/4	AA1233-2
			7/8	AA1233-3
			1	AA1233-4
			1-1/4	AA1233-5
			1-3/8	AA1233-6
			1-1/2	AA1233-7
			1-3/4	AA1233-8
			2	AA1233-9
			2-1/4	AA1233-10
			2-1/2	AA1233-11
			3	AA1233-12
	1.005	1.2525	1	AA1204-7
	1.004	1.2515	1-1/4	AA1204-2
			1-3/8	AA1204-1
			1-1/2	AA1204
			2	AA1204-3
			2-1/4	AA1204-5
			2-1/2	AA1204-4
1X1-5/16	1.001	1.316	1	AA1304-3
NOMINAL	1.000	1.315	1-1/2	AA1304
			1-3/4	AA1304-4
			2	AA1304-6
	1.002	1.315	1	AA1325-10
	1.001	1.314	1-1/4	AA1325-8
			1-1/2	AA1325-4
			1-5/8	AA1325-7
			1-3/4	AA1325-5
			2	AA1325
			2-1/2	AA1325-1
			2-3/4	AA1325-3
			3	AA1325-2

Note: The "AP-" prefix indicates Oilite Plus. All sizes can be special ordered in Oilite Plus.

Oilite®/Oilite Plus®

SLEEVE BEARINGS

	ID	OD	LENGTH	PART NO.
1X1-5/16	1.003	1.3165	1	AA1326-1
NOMINAL	1.002	1.3155	1-1/4	AA1326-2
(CONT.)			1-1/2	AA1326-3
			2	AA1326-4
			3	AA1326-5
1X1-3/8	1.001	1.378	3/4	AA1334-3
NOMINAL	1.000	1.377	1-1/4	AA1334-5
			1-1/2	AA1334-1
			2	AA1334-2
	1.003	1.377	1	AA1310-2
	1.002	1.376	1-1/8	AA1310-1
			1-1/4	AA1310-4
			1-3/8	AA1310
			1-1/2	AA1310-5
			1-3/4	AA1310-8
			2	AA1310-3
			2-1/4	AA1310-6
	1.003	1.379	1	AA1311-1
	1.002	1.378	1-1/4	AA1311-2
			1-1/2	AA1311-3
			1-3/4	AA1311-4
			2	AA1311-5
			2-1/2	AA1311-6
1X1-1/2	1.003	1.504	1	AA1510-1
NOMINAL	1.002	1.503	1-1/4	AA1510-2
			1-1/2	AA1510-3
			1-3/4	AA1510-4
			2	AA1510-5
			2-1/2	AA1510-6
			3	AA1510-7
	1.0035	1.5045	1	AA1511-7
	1.0025	1.5035	1-1/4	AA1511-8
			1-1/2	AA1511-5
			2	AA1511-1
1-1/16X1-5/16	1.064	1.317	3/4	AA1307-2
NOMINAL	1.063	1.316	1	AA1307-4
			1-1/4	AA1307-5
			1-1/2	AA1307-1
1-1/8X1-1/4	1.1245	1.2535	7/8	AA1214-6
NOMINAL	1.1235	1.2525	1	AA1214-3
			1-1/8	AA1214-2
			1-1/4	AA1214-1
			1-1/2	AA1214-8
	1.127	1.3155	1-1/4	AA1250-2
	1.126	1.3145	1-1/2	AA1250-3
1-1/8X1-5/16	1.1265	1.3155	1	AA1317
NOMINAL	1.1255	1.3145	1-1/4	AA1317-1
	1.128	1.3165	1	AA1318-1
	1.127	1.3155	1-1/4	AA1318-2
			1-1/2	AA1318-3
			1-3/4	AA1318-4
			2	AA1318-5
1-1/8X1-3/8	1.127	1.377	1/2	AA1332-6
NOMINAL	1.126	1.376	3/4	AA1332-1
			1	AA1332-4
			1-1/4	AA1332-9
			1-1/2	AA1332-7
			1-3/4	AA1332-10
			2	AA1332
			2-1/4	AA1332-11
			2-1/2	AA1332-2
			3	AA1332-8

	ID	OD	LENGTH	PART NO.
1-1/8X1-3/8	1.128	1.379	3/4	AA1320-5
NOMINAL	1.127	1.378	1-1/2	AA1320-1
(CONT.)			1-3/4	AA1320-2
			2	AA1320-3
			2-1/2	AA1320-4
	1.129	1.379	1/2	AA1319-10
	1.128	1.378	1	AA1319-3
			1-1/4	AA1319
			1-1/2	AA1319-13
			1-3/4	AA1319-5
			2	AA1319-1
			2-1/4	AA1319-12
			2-1/2	AA1319-2
1-1/8X1-1/2	1.126	1.503	1	AA1509-4
NOMINAL	1.125	1.502	1-1/2	AA1509-1
			1-3/4	AA1509-6
			2	AA1509
			2-1/2	AA1509-3
	1.127	1.5035	1	AA1502
	1.126	1.5025	1-1/4	AA1502-2
			1-1/2	AA1502-3
	1.128	1.504	1	AA1530-1
	1.127	1.503	1-1/4	AA1530-2
			1-1/2	AA1530-3
			1-3/4	AA1530-4
			2	AA1530-5
			2-1/2	AA1530-6
1-3/16X1-5/16	1.189	1.3155	1	AA1339-2
NOMINAL	1.188	1.3145	1-1/4	AA1339
1-3/16X1-3/8	1.189	1.379	1-1/2	AA1324-1
NOMINAL	1.188	1.378	1-3/4	AA1324
1-3/16X1-7/16	1.1885	1.441	1-1/4	AA1403-3
NOMINAL	1.1875	1.440	1-1/2	AA1403-7
			2	AA1403-10
	1.1905	1.4415	1-1/4	AA1404-1
	1.1895	1.4405	1-1/2	AA1404-2
			2	AA1404-3
			2-1/2	AA1404-4
			3	AA1404-5
1-3/16X1-1/2	1.190	1.504	1	AA1523-2
NOMINAL	1.189	1.503	1-1/2	AA1523-5
			2	AA1523
			2-1/2	AA1523-3
	1.1905	1.504	1	AA1525-1
	1.1895	1.503	1-1/4	AA1525-2
			1-1/2	AA1525-3
			1-3/4	AA1525-4
			2	AA1525-5
			2-1/2	AA1525-6
			3	AA1525-7
	1.193	1.504	1	AA1504-6
	1.192	1.503	1-1/2	AA1504-1
1-1/4X1-7/16	1.2515	1.4405	1-1/4	AA1407-4
NOMINAL	1.2505	1.4395	1-1/2	AA1407-5
			1-3/4	AA1407
			2	AA1407-6
			2-1/2	AA1407-8
1-1/4X1-1/2	1.250	1.502	3/4	AA1517-4
NOMINAL	1.249	1.501	1-1/4	AA1517-6
			1-5/8	AA1517-1

	ID	OD	LENGTH	PART NO.
1-1/4X1-1/2	1.252	1.502	1/2	AA1512-12
NOMINAL	1.251	1.501	5/8	AA1512-11
(CONT.)			3/4	AA1512-14
			7/8	AA1512-7
			1	AA1512-15
			1-1/4	AA1512-16
			1-3/8	AA1512-3
			1-1/2	AA1512-2
			1-3/4	AA1512-17
			1-7/8	AA1512-1
			2	AA1512-5
			2-1/2	AA1512-13
	1.252	1.502	5/8	API512-11
	1.251	1.501	3/4	API512-14
			1	API512-15
			1-1/4	API512-16
			1-1/2	API512-2
	1.2535	1.504	1	AA1528
	1.2525	1.503	1-1/4	AA1528-3
			1-1/2	AA1528-4
	1.254	1.504	1/2	AA1524-1
	1.253	1.503	5/8	AA1524-6
			3/4	AA1524-2
			7/8	AA1524-7
			1	AA1524-3
			1-1/8	AA1524-8
			1-1/4	AA1524-4
			1-3/8	AA1524-9
			1-1/2	AA1524-5
			1-5/8	AA1524-10
			1-3/4	AA1524-11
			1-7/8	AA1524-12
			2	AA1524-13
			2-1/4	AA1524-14
			2-1/2	AA1524-15
			3	AA1524-16
	1.258	1.504	1	AA1505-11
	1.257	1.503	1-1/2	AA1505-1
1-1/4X1-9/16	1.252	1.565	1-1/4	AA1506-12
NOMINAL	1.251	1.5635	1-1/2	AA1506-6
			1-3/4	AA1506
			2	AA1506-7
			2-1/4	AA1506-8
1-1/4X1-5/8	1.250	1.627	1-1/2	AA1602
NOMINAL	1.249	1.6255		
	1.252	1.6275	1	AA1606-9
	1.251	1.626	1-1/4	AA1606
			1-1/2	AA1606-7
			1-5/8	AA1606-11
			1-3/4	AA1606-1
			2	AA1606-3
			2-1/2	AA1606-5
			3	AA1606-4
	1.2535	1.630	1	AA1607-1
	1.2525	1.6285	1-1/4	AA1607-2
			1-1/2	AA1607-3
			1-3/4	AA1607-4
			2	AA1607-5
			2-1/2	AA1607-6
			3	AA1607-7
	1.254	1.629	1-1/2	AA1604
	1.253	1.6275	1-3/4	AA1604-2
1-1/4X1-3/4	1.2535	1.755	1-3/4	AA1716-1
NOMINAL	1.2525	1.7535	2	AA1716-2
			2-1/2	AA1716-3
			3	AA1716-4

Note: The "AP-" prefix indicates Oilite Plus. All sizes can be special ordered in Oilite Plus.

Oilite®/Oilite Plus®

SLEEVE BEARINGS

	ID	OD	LENGTH	PART NO.
1-1/4X1-3/4	1.254	1.753	1-1/2	AA1715-6
NOMINAL	1.253	1.7515	2	AA1715-2
(CONT.)			3	AA1715-3
1-5/16X1-1/2	1.3155	1.503	1	AA1526-4
NOMINAL	1.3145	1.5015	1-1/4	AA1526
			1-1/2	AA1526-2
			2	AA1526-3
1-5/16X1-5/8	1.3155	1.629	1-1/2	AA1611-5
NOMINAL	1.3145	1.6275	2	AA1611-2
			2-1/2	AA1611
1-3/8X1-9/16	1.3745	1.5655	1-1/4	AA1507-2
NOMINAL	1.3735	1.564	1-1/2	AA1507
1-3/8X1-5/8	1.376	1.628	1	AA1608-10
NOMINAL	1.375	1.6265	1-1/8	AA1608-1
			1-1/4	AA1608-11
			1-1/2	AA1608-12
			1-3/4	AA1608-13
			2	AA1608
			2-1/2	AA1608-3
	1.3785	1.630	1	AA1610-1
	1.3775	1.6285	1-1/8	AA1610-2
			1-1/4	AA1610-3
			1-1/2	AA1610-4
			2	AA1610-5
			2-1/2	AA1610-6
			3	AA1610-7
	1.379	1.628	1-1/2	AA1616-3
	1.378	1.6265	2	AA1616-5
			2-1/2	AA1616-7
1-3/8X1-3/4	1.3785	1.755	1	AA1709-1
NOMINAL	1.3775	1.7535	1-1/2	AA1709-2
			2	AA1709-3
			2-1/2	AA1709-4
			3	AA1709-5
	1.380	1.753	1-1/2	AA1708-5
	1.379	1.7515	2	AA1708-2
			2-1/2	AA1708
1-7/16X1-5/8	1.438	1.628	1	AA1609-2
NOMINAL	1.437	1.6265	1-1/2	AA1609-4
			2	AA1609
			2-1/4	AA1609-6
	1.441	1.630	1	AA1603-1
	1.440	1.6285	1-1/2	AA1603-2
			2	AA1603-3
1-7/16X1-3/4	1.441	1.755	1	AA1705-1
NOMINAL	1.440	1.7535	1-1/4	AA1705-2
			1-1/2	AA1705-3
			1-3/4	AA1705-4
			2	AA1705-5
			2-1/2	AA1705-6
			3	AA1705-7
	1.4425	1.7535	7/8	AA1703-1
	1.4415	1.752	1	AA1703-11
			1-1/8	AA1703-14
			1-1/4	AA1703-4
			1-1/2	AA1703-6
			1-3/4	AA1703-3
			1-7/8	AA1703
			2	AA1703-7
			2-1/4	AA1703-10
			2-1/2	AA1703-5

	ID	OD	LENGTH	PART NO.
1-1/2X1-11/16	1.507	1.691	3/4	AA1612-4
NOMINAL	1.506	1.6895	1	AA1612-1
1-1/2X1-3/4	1.503	1.754	1/2	AA1704-20
NOMINAL	1.502	1.7525	5/8	AA1704-21
			3/4	AA1704-16
			7/8	AA1704-4
			1	AA1704-15
			1-1/8	AA1704-17
			1-1/4	AA1704-11
			1-3/8	AA1704-5
			1-1/2	AA1704
			1-3/4	AA1704-3
			2	AA1704-2
			2-1/4	AA1704-7
			2-1/2	AA1704-8
			3	AA1704-9
			3-1/2	AA1704-19
	1.503	1.754	3/4	AP1704-16
	1.502	1.7525	1	AP1704-15
			1-1/4	AP1704-11
			1-1/2	AP1704
	1.504	1.755	1/2	AA1706-1
	1.503	1.7535	5/8	AA1706-2
			3/4	AA1706-3
			7/8	AA1706-4
			1	AA1706-5
			1-1/4	AA1706-6
			1-3/8	AA1706-7
			1-1/2	AA1706-8
			1-3/4	AA1706-9
			2	AA1706-10
			2-1/4	AA1706-11
			2-1/2	AA1706-12
			3	AA1706-13
1-1/2X1-13/16	1.502	1.815	1	AA1801-1
NOMINAL	1.501	1.8135	1-5/8	AA1801
1-1/2X1-7/8	1.503	1.878	1-1/2	AA1807-9
NOMINAL	1.502	1.8765	1-3/4	AA1807-10
			2	AA1807
			2-1/2	AA1807-11
			2-3/4	AA1807-1
			3	AA1807-2
	1.504	1.880	1-1/2	AA1806-1
	1.503	1.879	2	AA1806-2
			2-1/2	AA1806-3
			3	AA1806-4
	1.504	1.880	1-1/2	AA1820-1
	1.503	1.8785	2	AA1820-2
			2-1/2	AA1820-3
			3	AA1820-4
1-1/2X2	1.503	2.004	1	AA2007-6
NOMINAL	1.502	2.0025	1-1/2	AA2007-1
			2	AA2007-2
			2-1/2	AA2007-3
			3-1/2	AA2007-5
	1.504	2.005	1	AA2008-1
	1.503	2.0035	1-1/2	AA2008-2
			2	AA2008-3
			2-1/2	AA2008-4
			3	AA2008-5
			3-1/2	AA2008-6
1-5/8X1-7/8	1.627	1.879	1	AA1803-10
NOMINAL	1.6255	1.8775	1-1/4	AA1803-11
			1-1/2	AA1803-13

	ID	OD	LENGTH	PART NO.
1-5/8X1-7/8	1.627	1.879	1-3/4	AA1803-14
NOMINAL	1.6255	1.8775	2	AA1803-7
(CONT.)			2-1/4	AA1803-1
			2-3/4	AA1803-15
	1.629	1.880	1-1/4	AA1804-1
	1.6275	1.8785	1-1/2	AA1804-2
			1-3/4	AA1804-3
			2	AA1804-4
			2-1/4	AA1804-5
1-5/8X2	1.6265	2.004	1-1/2	AA2000-5
NOMINAL	1.625	2.0025	2	AA2000-1
			2-1/2	AA2000-3
			3	AA2000-4
	1.629	2.005	1	AA2003-1
	1.6275	2.0035	1-1/2	AA2003-2
			2	AA2003-3
			2-1/2	AA2003-4
			3	AA2003-5
1-11/16X2-3/16	1.6905	2.1915	2	AA2107-1
NOMINAL	1.689	2.190		
	1.6915	2.1925	2	AA2108-1
	1.690	2.191		
1-3/4X1-15/16	1.7525	1.9415	1-1/4	AA1904-2
NOMINAL	1.751	1.940	1-1/2	AA1904-3
1-3/4X2	1.753	2.004	1	AA2001-11
NOMINAL	1.7515	2.0025	1-1/2	AA2001-3
	1.754	2.005	1	AA2002-1
	1.7525	2.0035	1-1/4	AA2002-2
			1-1/2	AA2002-3
			1-3/4	AA2002-4
			2	AA2002-5
			2-1/2	AA2002-6
			3	AA2002-7
1-3/4X2-1/8	1.754	2.128	1/2	AA2112-8
NOMINAL	1.7525	2.1265	1-1/2	AA2112-1
			2	AA2112-2
			2-1/2	AA2112-3
	1.754	2.130	1-1/2	AA2114-1
	1.7525	2.1285	2	AA2114-2
			3	AA2114-3
1-3/4X2-1/4	1.753	2.253	2	AA2204-2
NOMINAL	1.7515	2.2515	2-1/2	AA2204-3
			3	AA2204
1-7/8X2-1/4	1.878	2.254	3/4	AA2202-10
NOMINAL	1.8765	2.2525	2	AA2202
			2-1/2	AA2202-1
			3	AA2202-2
1-15/16X2-1/8	1.940	2.1285	2	AA2102-3
NOMINAL	1.9385	2.127	2-1/2	AA2102-1
1-15/16X2-5/16	1.9405	2.3165	2	AA2306-3
NOMINAL	1.939	2.315	3	AA2306-5

Note: The "AP-" prefix indicates Oilite Plus. All sizes can be special ordered in Oilite Plus.

Oilite®/Oilite Plus®

SLEEVE BEARINGS

	ID	OD	LENGTH	PART NO.
1-15/16 X 2-5/16	1.9415	2.3175	2	AA2307-1
NOMINAL	1.940	2.316	2-1/2	AA2307-2
(CONT.)			3	AA2307-3
			4	AA2307-4
1-15/16 X 2-7/16	1.942	2.4415	1-1/2	AA2403-1
NOMINAL	1.9405	2.440	2	AA2403-2
2 X 2-1/4	2.003	2.254	3/4	AA2203-5
NOMINAL	2.0015	2.2525	1	AA2203-6
			1-1/2	AA2203-7
			2	AA2203
			2-1/2	AA2203-9
			3	AA2203-10
	2.003	2.254	1	AP2203-6
	2.0015	2.2525	1-1/2	AP2203-7
			2	AP2203
	2.004	2.255	1	AA2213-1
	2.0025	2.2535	1-1/2	AA2213-2
			2	AA2213-3
			2-1/2	AA2213-4
			3	AA2213-5
2 X 2-3/8	2.003	2.379	1-1/8	AA2304-6
NOMINAL	2.0015	2.3775	1-1/2	AA2304-7
			1-3/4	AA2304
			2	AA2304-1
			2-1/2	AA2304-2
			3	AA2304-3
			4	AA2304-5
2 X 2-1/2	2.003	2.503	1-1/2	AA2501-1
NOMINAL	2.0015	2.501	2	AA2501-2
			2-1/2	AA2501-3
			3	AA2501
	2.003	2.503	1-1/2	AP2501-1
	2.0015	2.501	2	AP2501-2
	2.004	2.505	1	AA2502-1
	2.0025	2.5035	1-1/2	AA2502-2
			2	AA2502-3
			2-1/2	AA2502-4
			3	AA2502-5
2-3/16 X 2-3/8	2.190	2.379	1-1/2	AA2303-1
NOMINAL	2.1885	2.3775		
2-1/4 X 2-5/8	2.254	2.6295	2	AA2605-3
NOMINAL	2.2525	2.6275	3	AA2605-5
			3-1/2	AA2605
	2.254	2.631	2	AA2606-1
	2.252	2.629	2-1/2	AA2606-2
			3	AA2606-30
2-1/4 X 2-3/4	2.253	2.753	1-1/2	AA2703-1
NOMINAL	2.2515	2.751	2	AA2703-2
			3	AA2703
	2.254	2.756	2	AA2707-1
	2.2525	2.754	3	AA2707-2
2-3/8 X 2-5/8	2.377	2.6295	1-1/4	AA2602-3
NOMINAL	2.3755	2.6275	1-5/8	AA2602
2-3/8 X 2-3/4	2.379	2.753	2	AA2701-2
NOMINAL	2.3775	2.751	2-1/2	AA2701-6
			3	AA2701
2-1/2 X 2-3/4	2.505	2.754	2	AA2702-5
NOMINAL	2.5035	2.752	2-1/2	AA2702-4
			3	AA2702-1

	ID	OD	LENGTH	PART NO.
2-1/2 X 2-3/4	2.505	2.756	2	AA2708-1
NOMINAL	2.5035	2.754	3	AA2708-2
(CONT.)			4	AA2708-3
2-1/2 X 2-7/8	2.504	2.880	2-1/4	AA2803-1
NOMINAL	2.5025	2.878	2-1/2	AA2803-3
			3	AA2803-2
	2.505	2.881	2-1/4	AA2804-1
	2.5035	2.879	2-1/2	AA2804-2
			3	AA2804-3
2-1/2 X 3	2.504	3.005	2	AA3005-7
NOMINAL	2.5025	3.003	2-1/2	AA3005-4
			3	AA3005-1
			4	AA3005
	2.505	3.006	2	AA3004-1
	2.5035	3.004	3	AA3004-2
			4	AA3004-3
2-3/4 X 3	2.753	3.005	1-1/2	AA3006-1
NOMINAL	2.751	3.003	2-1/2	AA3006
2-3/4 X 3-1/8	2.753	3.129	1-1/4	AA3100-7
NOMINAL	2.751	3.127	2-3/4	AA3100
2-3/4 X 3-1/4	2.752	3.254	1-1/2	AA3201-1
NOMINAL	2.750	3.252	2	AA3201-4
			3	AA3201-7
	2.755	3.257	2	AA4452-1
	2.753	3.255	3	AA4452-2
			4	AA4452-3
2-15/16 X 3-5/16	2.940	3.315	3	AA3301-3
NOMINAL	2.938	3.313		
3 X 3-1/4	3.002	3.255	1-1/4	AA3200-5
NOMINAL	3.000	3.253	2	AA3200
			3	AA3200-2
	3.006	3.257	2	AA4852-1
	3.004	3.255	3	AA4852-2
3 X 3-1/2	3.004	3.505	2-1/2	AA3502-7
NOMINAL	3.002	3.503	3	AA3502-8
	3.006	3.507	2	AA4856-1
	3.004	3.505	2-1/2	AA4856-2
			3	AA4856-3
			4	AA4856-4
3-1/4 X 3-5/8	3.253	3.628	4	AA3600-05
NOMINAL	3.2510	3.6255		
3-1/2 X 4	3.5035	4.004	2	AA4000-3
NOMINAL	3.5015	4.0015	3	AA4000-5
			3-1/2	AA4000-6
	3.507	4.008	3	AA5664-1
	3.505	4.0055	3-1/2	AA5664-2
			4	AA5664-3
4 X 4-1/2	4.0035	4.504	4	AA4500
NOMINAL	4.001	4.5015	6	AA4500-2
	4.008	4.509	4	AA6472-1
	4.0055	4.5065		
4 X 4-5/8	4.005	4.628	4	AA4600-5
NOMINAL	4.003	4.6245		
4-1/2 X 5-1/4	4.504	5.2545	5	AA5201
NOMINAL	4.5015	5.251		
5 X 5-3/4	5.004	5.755	2	AA5700-1
NOMINAL	5.0005	5.751		

Note: The "AP-" prefix indicates Oilite Plus. All sizes can be special ordered in Oilite Plus.



	ID	OD	LENGTH	FLANGE OD	FLANGE THICKNESS	PART NO.
1/8X1/4	.126	.252	1/4	5/16	1/16	FF207-2
NOMINAL	.125	.251	3/8			FF207-3
3/16X5/16	.187	.313	1/4	3/8	1/16	FF313-1
NOMINAL	.186	.312	3/8			FF313-2
	.1895	.314	3/16	7/16	1/16	FF303-1
	.1885	.313	1/4			FF303-3
			5/16			FF303-2
			3/8			FF303
			1/2			FF303-4
	.1895	.3155	3/16	7/16	1/16	FF314-1
	.1885	.3145	1/4			FF314-2
			5/16			FF314-3
			3/8			FF314-4
			1/2			FF314-5
3/16X3/8	.1895	.3765	3/8	7/16	1-16	FF307
NOMINAL	.1885	.3755	1/2			FF307-2
1/4X3/8	.250	.381	3/16	1/2	1/16	FF310
NOMINAL	.249	.380	1/4			FF310-3
			5/16			FF310-4
			3/8			FF310-1
			7/16			FF310-5
			1/2			FF310-2
			9/16			FF310-7
			11/16			FF310-10
	.252	.377	1/4	1/2	3/64	FF311-1
	.251	.376	3/8			FF311-2
			1/2			FF311-3
	.252	.3775	3/8	15/32	3/64	FF300
	.251	.3765				
	.252	.3775	3/16	15/32	1/16	FF312-3
	.251	.3765	1/4			FF312
			5/16			FF312-4
			3/8			FF312-1
			7/16			FF312-5
			1/2			FF312-2
			5/8			FF312-6
	.252	.3775	1/4	15/32	1/16	FP312
	.251	.3765	3/8			FP312-1
			1/2			FP312-2
	.252	.378	3/16	1/2	1/16	FF317
	.251	.377	1/4			FF317-1
			3/8			FF317-2
			7/16			FF317-6
			1/2			FF317-3
			5/8			FF317-5
			3/4			FF317-4
	.253	.377	3/8	1/2	1/16	FF375
	.252	.376	1/2			FF375-1
1/4X7/16	.251	.4395	1/2	1/2	1/16	FF435-1
NOMINAL	.250	.4385				
1/4X1/2	.252	.503	5/8	5/8	1/16	FF565-2
NOMINAL	.251	.502	3/4			FF565-3
5/16X7/16	.3125	.440	3/8	9/16	1/16	FF411-1
NOMINAL	.3115	.439	1/2			FF411-2
			7/8			FF411-4
	.3145	.4405	3/8	9/16	1/16	FF413-1
	.3135	.4395	1/2			FF413-2
			3/4			FF413-3
5/16X1/2	.3135	.502	3/8	9/16	1/16	FF501-2
NOMINAL	.3125	.501				

	ID	OD	LENGTH	FLANGE OD	FLANGE THICKNESS	PART NO.
3/8X1/2	.3765	.502	1/4	5/8	1/16	FF520-15
NOMINAL	.3755	.501	5/16			FF520-9
			3/8			FF520-10
			1/2			FF520-5
	.3765	.502	1/4	5/8	1/16	FP520-15
	.3755	.501	3/8			FP520-10
			1/2			FP520-5
	.3765	.503	1/2	5/8	3/32	FF512-2
	.3755	.502	5/8			FF512-3
	.377	.502	3/8	11/16	3/32	FF511-1
	.376	.501	1/2			FF511-2
			5/8			FF511-3
	.377	.503	1/4	11/16	1/16	FF318-1
	.376	.502	3/8			FF318-5
			1/2			FF318-2
			3/4			FF318-3
			1			FF318-4
	.378	.503	1/2	3/4	3/32	FF519-2
	.377	.502				
3/8X9/16	.376	.564	1/2	.740	1/16	FF503-6
NOMINAL	.375	.563	11/16			FF503-4
			13/16			FF503
	.377	.5655	1/2	11/16	1/16	FF320-1
	.376	.5645	3/4			FF320-2
3/8X5/8	.376	.627	1/2	7/8	1/16	FF607-2
NOMINAL	.375	.625	3/4			FF607-3
			1-1/4			FF607-1
	.377	.628	1/2	7/8	1/16	FF319-1
	.376	.627	3/4			FF319-2
			1			FF319-3
			1-1/4			FF319-4
7/16X9/16	.439	.565	1/2	11/16	1/16	FF504-3
NOMINAL	.438	.564	5/8			FF504
			3/4			FF504-1
	.4395	.5655	1/2	11/16	1/16	FF505-1
	.4385	.5645	1-3/4			FF505-2
7/16X5/8	.4385	.627	3/4	7/8	1/8	FF608-3
NOMINAL	.4375	.626	1-1/4			FF608
	.4395	.628	3/4	7/8	1/8	FF619-1
	.4385	.627	1-1/4			FF619-2
1/2X5/8	.502	.627	1/2	31/32	3/32	FF600-5
NOMINAL	.501	.626	1			FF600-2
			1-3/4			FF600
	.502	.627	3/16	7/8	1/16	FF620-9
	.501	.626	1/4			FF620-13
			3/8			FF620-8
			1/2			FF620-1
			9/16			FF620-5
			5/8			FF620-7
			1			FF620-3
			1-1/8			FF620-4
	.502	.627	1/4	7/8	1/16	FP620-13
	.501	.626	3/8			FP620-8
			1/2			FP620-1
			9/16			FP620-5
			5/8			FP620-7
	.502	.627	5/16	3/4	3/32	FF636-3
	.501	.626	3/8			FF636-2

Note: The "FP-" prefix indicates Oilite Plus. All sizes can be special ordered in Oilite Plus.



	ID	OD	LENGTH	FLANGE OD	FLANGE THICKNESS	PART NO.	
1/2 X 5/8 NOMINAL (CONT.)	.502	.628	5/16	7/8	1/8	FF611-9	
	.501	.627	3/8			FF611-1	
			1/2			FF611-2	
			5/8			FF611-3	
			3/4			FF611-4	
			7/8			FF611-5	
			1			FF611-6	
			1-1/4			FF611-7	
			1-1/2			FF611-8	
1/2 X 11/16 NOMINAL	.502	.6905	5/16	7/8	1/8	FF623-1	
	.501	.6895	1/2			FF623-2	
			3/4			FF623-3	
	.502	.691	1/2	31/32	3/32	FF604-2	
	.501	.690	3/4			FF604-1	
			13/16			FF604	
	.502	.691	5/16	13/16	1/16	FF609-1	
	.501	.690	1/2			FF609-3	
			3/4			FF609-4	
		13/16			FF609		
1/2 X 3/4 NOMINAL	.502	.753	1/2	1	1/8	FF621-1	
	.501	.752	5/8			FF621-2	
			3/4			FF621-3	
			1			FF621-4	
			1-1/4			FF621-5	
	.502	.753	1/2	15/16	1/8	FF707-5	
	.501	.752	3/4			FF707-2	
			1			FF707-3	
	.503	.753	3/4	15/16	1/8	FF710	
	.502	.752					
	.505	.753	3/8	1	1/8	FF723-5	
	.504	.752	1/2			FF723-1	
			5/8			FF723	
	5/8 X 3/4 NOMINAL	.626	.753	1/2	1	1/8	FF711-1
		.625	.752	5/8			FF711-2
			3/4			FF711-3	
			1			FF711-4	
.6265		.7525	1/2	1	3/32	FF703-2	
.6255		.7515	5/8			FF703-3	
			3/4			FF703-7	
			1			FF703-1	
			1-1/8			FF703	
			1-1/4			FF703-6	
.6275		.7525	1/2	7/8	1/16	FF718-1	
.6265		.7515	1			FF718-3	
			1-1/8			FF718-6	
5/8 X 13/16 NOMINAL		.625	.815	1	1	1/8	FF823-3
		.624	.814	1-1/4			FF823
	.626	.815	1/2	1	1/8	FF842-1	
	.625	.814	3/4			FF842-2	
			1			FF842-3	
	.627	.8165	3/4	1	1/8	FF844-1	
	.626	.8155	1			FF844-2	
			1-1/4			FF844-3	
			1-1/2			FF844-4	
	.628	.816	3/4	1-1/4	1/8	FF806-1	
	.627	.815	1-7/16			FF806	
	.6295	.8155	1/2	1	1/8	FF805-2	
	.6285	.8145	3/4			FF805	
			1			FF805-3	

	ID	OD	LENGTH	FLANGE OD	FLANGE THICKNESS	PART NO.
5/8 X 7/8 NOMINAL	.627	.877	5/8	1	1/8	FF843-4
	.626	.876	3/4			FF843
			1			FF843-2
			1-1/4			FF843-3
	.627	.879	1/2	1-1/8	1/8	FF852-1
	.626	.878	5/8			FF852-2
			3/4			FF852-3
			1			FF852-4
			1-1/4			FF852-5
5/8 X 1 NOMINAL	.627	1.004	1	1-1/4	3/16	FF855-1
	.626	1.003				
3/4 X 7/8 NOMINAL	.751	.877	1/2	1	1/16	FF838-1
	.750	.876	1			FF838-3
	.752	.879	1/2	1-1/8	1/8	FF854-1
	.751	.878	3/4			FF854-2
3/4 X 15/16 NOMINAL	.7505	.941	3/4	1-1/8	3/32	FF911-3
	.7495	.940	1			FF911-4
	.752	.9415	3/4	1-1/4	1/8	FF1115-1
	.751	.9405	1			FF1115-2
			1-1/8			FF1115-3
			1-1/4			FF1115-4
	.753	.938	3/4	1-5/16	1/8	FF901-6
	.752	.937	1-1/4			FF901-8
			1-5/16			FF901-4
			1-9/16			FF901
3/4 X 1 NOMINAL	.7505	1.002	1/2	1-7/16	1/8	FF1011-2
	.7495	1.001	5/8			FF1011
			1			FF1011-4
			1-1/8			FF1011-1
	.751	1.002	3/4	1-1/2	1/8	FF1013-2
	.750	1.001	1			FF1013
			1-1/4			FF1013-3
			1-1/2			FF1013-4
	.751	1.002	3/4	1-1/2	1/8	FP1013-2
	.750	1.001	1			FP1013
		1-1/4			FP1013-3	
.752	1.002	3/4	1-5/16	1/8	FF1014-2	
.751	1.001	1			FF1014	
.752	1.003	5/8	1-1/4	5/32	FF1012-1	
.751	1.002	3/4			FF1012-2	
		1			FF1012-3	
		1-1/4			FF1012-4	
.752	1.004	5/8	1-1/4	3/16	FF1016-1	
.751	1.003	3/4			FF1016-2	
		1			FF1016-3	
		1-1/8			FF1016-6	
		1-1/4			FF1016-4	
		1-1/2			FF1016-5	
.753	1.003	1/2	1-1/8	1/8	FF1015-1	
.752	1.002	5/8			FF1015-4	
		3/4			FF1015-2	
		1			FF1015	
		1-1/2			FF1015-3	
3/4 X 1-1/16 NOMINAL	.752	1.0655	1-3/16	1-3/16	1/8	FF1010
	.751	1.0645				
7/8 X 1 NOMINAL	.8765	1.003	5/8	1-1/4	1/8	FF1001-2
	.8755	1.002	3/4			FF1001-1
		1			FF1001	

Note: The "FP-" prefix indicates Oilite Plus. All sizes can be special ordered in Oilite Plus.



	ID	OD	LENGTH	FLANGE OD	FLANGE THICKNESS	PART NO.
7/8X1	.877	1.004	1/2	1-1/4	3/16	FF1017-1
NOMINAL	.876	1.003	3/4			FF1017-2
(CONT.)			1			FF1017-3
7/8X1-1/8	.877	1.128	5/8	1-1/2	1/8	FF1102-6
NOMINAL	.876	1.127	1			FF1102-2
			1-1/4			FF1102-3
			1-3/4			FF1102
	.877	1.129	3/4	1-1/2	1/8	FF1018-1
	.876	1.128	1			FF1018-2
			1-1/4			FF1018-3
			1-1/2			FF1018-4
			1-3/4			FF1018-5
1X1-1/4	1.001	1.252	3/4	1-1/2	1/8	FF1213-1
NOMINAL	1.000	1.251	1-1/2			FF1213-4
	1.001	1.253	3/4	1-7/8	1/8	FF1202-4
	1.000	1.252	1			FF1202-3
			1-1/4			FF1202
	1.002	1.252	3/4	1-5/8	1/8	FF1207-5
	1.001	1.251	1-1/4			FF1207-7
			1-1/2			FF1207-3
			1-3/4			FF1207
	1.002	1.252	3/4	1-5/8	1/8	FP1207-5
	1.001	1.251	1-1/4			FP1207-7
			1-1/2			FP1207-3
	1.002	1.253	3/4	1-1/2	3/16	FF1211-1
	1.001	1.252	1			FF1211-2
			1-1/4			FF1211-3
	1.003	1.254	3/4	1-1/2	1/8	FF1214-1
	1.002	1.253	1			FF1214-2
			1-1/4			FF1214-3
			1-1/2			FF1214-4
1X1-5/16	1.001	1.316	1-1/4	1-3/4	7/32	FF1302
NOMINAL	1.000	1.315	1-1/2			FF1302-3
	1.0015	1.3155	1-1/2	1-7/8	1/8	FF1301
	1.0005	1.3145				
1X1-3/8	1.000	1.3785	1-3/4	1-3/4	3/16	FF1304
NOMINAL	.999	1.3775	2			FF1304-1
	1.003	1.379	3/4	1-5/8	3/16	FF1305-1
	1.002	1.378	1			FF1305-2
			1-1/2			FF1305-3
			1-3/4			FF1305-4
			2			FF1305-6
1-1/8X1-3/8	1.127	1.377	3/4	1-3/4	1/8	FF1314-1
NOMINAL	1.126	1.376	1			FF1314-2
			1-1/4			FF1314-3
1-1/4X1-1/2	1.2515	1.503	1/2	1-11/16	1/8	FF1505-5
NOMINAL	1.2505	1.502	3/4			FF1505-6
			1-1/4			FF1505
	1.252	1.503	1-1/2	2	3/32	FF1506-4
	1.251	1.502	1-3/4			FF1506-5
	1.2535	1.504	1	1-3/4	3/16	FF1507-1
	1.2525	1.503	1-1/4			FF1507-2
			1-1/2			FF1507-3
			1-3/4			FF1507-4
1-3/8X1-5/8	1.377	1.628	3/4	2	1/8	FF1618
NOMINAL	1.376	1.6265	1			FF1618-1
1-1/2X1-3/4	1.503	1.752	3/4	2	3/32	FF1704-1
NOMINAL	1.502	1.7505	1			FF1704-2
			1-1/2			FF1704-4
	1.504	1.755	1-1/2	2	3/16	FF1705-1
	1.503	1.7535				

	ID	OD	LENGTH	FLANGE OD	FLANGE THICKNESS	PART NO.
1-5/8X2	1.6265	2.004	2	2-1/4	3/16	FF2000
NOMINAL	1.625	2.0025				
	1.629	2.005	2	2-1/4	3/16	FF2002-1
	1.6275	2.0035				
1-3/4X2-1/4	1.753	2.254	2-1/2	3	1/4	FF2204-3
NOMINAL	1.7515	2.253				
	1.754	2.255	2-1/2	3	1/4	FF2005-1
	1.753	2.254				
2X2-1/4	2.003	2.254	3/4	2-1/2	1/8	FF2203-2
NOMINAL	2.0015	2.2535	1			FF2203-3
			1-1/4			FF2203-4
	2.004	2.255	2	2-1/2	1/8	FF2206-1
	2.0025	2.2535				
2X2-1/2	2.002	2.501	2-3/8	3	3/8	FF2501
NOMINAL	2.0005	2.4995				
2-3/4X3-1/4	2.752	3.250	1-1/2	4	3/16	FF3200-4
NOMINAL	2.750	3.248				
3X3-1/2	3.002	3.502	2-3/8	4	3/8	FF3500
NOMINAL	3.000	3.500				

Note: The "FP-" prefix indicates Oilite Plus. All sizes can be special ordered in Oilite Plus.

Oilite®/Oilite Plus®

THRUST BEARINGS

	ID	OD	THICKNESS	PART NO.		ID	OD	THICKNESS	PART NO.
1/4 X 7/16 NOMINAL	.260	.4675	1/16	TT400	5/8 X 1-3/16 NOMINAL	.632	1.1975	1/16	TT1102-1
	.250	.4475				.622	1.1775	3/32	TT1102
1/4 X 1/2 NOMINAL	.260	.510	1/16	TP400			1/8	TT1102-2	
	.250	.490			.632	1.1975	1/16	TP1102-1	
1/4 X 5/8 NOMINAL	.260	.510	1-16	TP504	.622	1.1775	3/32	TP1102	
	.250	.490					1/8	TP1102-2	
1/4 X 5/8 NOMINAL	.260	.635	1/16	TT601	5/8 X 1-1/4 NOMINAL	.633	1.260	1/16	TT1204
	.250	.615				.623	1.240	1/8	TT1204-1
5/16 X 5/8 NOMINAL	.260	.635	1/16	TP601	.633	1.260	1/16	TP1204	
	.250	.615			.623	1.240	1/8	TP1204-1	
5/16 X 3/4 NOMINAL	.3195	.635	1/16	TT602	5/8 X 1-1/2 NOMINAL	.661	1.510	1/16	TT1508-1
	.3095	.615				.651	1.490	1/8	TT1508-2
5/16 X 3/4 NOMINAL	.3195	.635	1/16	TP602	.661	1.510	1/16	TP1508-1	
	.3095	.615			.651	1.490	1/8	TP1508-2	
5/16 X 3/4 NOMINAL	.320	.760	1-16	TT709-1	3/4 X 1-1/4 NOMINAL	.758	1.260	1/16	TT1205
	.310	.740				.748	1.240	1/8	TT1205-1
3/8 X 5/8 NOMINAL	.320	.760	1/16	TP709-1	.758	1.260	1/16	TP1205	
	.310	.740			.748	1.240	1/8	TP1205-1	
3/8 X 5/8 NOMINAL	.390	.635	1/16	TT604	3/4 X 1-3/8 NOMINAL	.758	1.385	1/16	TT1303-1
	.380	.615				.748	1.365	1/8	TT1303-2
3/8 X 3/4 NOMINAL	.390	.635	1/16	TP604	.758	1.385	1/16	TP1303-1	
	.380	.615			.748	1.365	1/8	TP1303-2	
3/8 X 3/4 NOMINAL	.3825	.760	1/16	TT710-1			1/4	TP1303-4	
	.3725	.740	1/8	TT710-2	3/4 X 1-9/16 NOMINAL	.770	1.5775	3/32	TT1501-1
.3825	.760	1/16	TP710-1	.760		1.5475			
7/16 X 3/4 NOMINAL	.3725	.740	1/8	TP710-2	.770	1.5775	3/32	TP1501-1	
	.395	.760	1/32	TT703	.760	1.5475			
1/2 X 3/4 NOMINAL	.395	.760	1/32	TP703	3/4 X 1-3/4 NOMINAL	.770	1.765	1/8	TT1701
	.385	.740				.760	1.735		
1/2 X 3/4 NOMINAL	.395	.760	1/32	TP703	.770	1.765	1/8	TP1701	
	.385	.740			.760	1.735			
1/2 X 7/8 NOMINAL	.4435	.760	1/16	TT705-1	7/8 X 1-1/2 NOMINAL	.8955	1.515	1/16	TT1503-2
	.4335	.740				.8855	1.485	1/8	TT1503
1/2 X 3/4 NOMINAL	.4435	.760	1/16	TP705-1	.8955	1.515	1/16	TP1503-2	
	.4335	.740			.8855	1.485	1/8	TP1503	
1/2 X 3/4 NOMINAL	.512	.760	1/16	TT706	7/8 X 2 NOMINAL	.885	2.015	1/8	TT2007
	.502	.740				.875	1.985		
1/2 X 7/8 NOMINAL	.512	.760	1/16	TP706	.885	2.015	1/8	TP2007	
	.502	.740			.875	1.985			
1/2 X 7/8 NOMINAL	.510	.885	3/16	TT801	7/8 X 2-1/8 NOMINAL	.8955	2.140	1/8	TT2101-1
	.500	.865				.8855	2.110		
1/2 X 7/8 NOMINAL	.510	.885	3/16	TP801	.8955	2.140	1/8	TP2101-1	
	.500	.865			.8855	2.110			
1/2 X 1 NOMINAL	.515	1.010	1/16	TT1001	1 X 1-1/2 NOMINAL	1.008	1.519	1/16	TT1502-2
	.505	.990	3/32	TT1001-2		.998	1.489	1/8	TT1502
9/16 X 1-1/4 NOMINAL	.515	1.010	1/16	TP1001			3/16	TT1502-1	
	.505	.990	3/32	TP1001-2	1.008	1.519	1/16	TP1502-2	
9/16 X 1-1/4 NOMINAL	.570	1.260	1/16	TT1200-1	.998	1.489	1/8	TP1502	
	.560	1.240	1/8	TT1200			3/16	TP1502-1	
5/8 X 1 NOMINAL	.570	1.260	1/16	TP1200-1	1 X 1-5/8 NOMINAL	1.0205	1.640	1/16	TT1603-3
	.560	1.240	1/8	TP1200		1.0105	1.610	1/8	TT1603
5/8 X 1 NOMINAL	.633	1.010	1/16	TT1002-1			1/4	TT1603-4	
	.623	.990	1/8	TT1002	1.0205	1.640	1/16	TP1603-3	
5/8 X 1 NOMINAL	.633	1.010	1/16	TP1002-1	1.0105	1.610	1/8	TP1603	
	.623	.990	1/8	TP1002			1/4	TP1603-4	

Note: The "TP-" prefix indicates Oilite Plus.

Oilite®/Oilite Plus®

THRUST BEARINGS

	ID	OD	THICKNESS	PART NO.
1X1-3/4 NOMINAL	1.017	1.765	1/16	TT1709-1
	1.007	1.735	1/8	TT1709
	1.017	1.765	1/16	TP1709-1
	1.007	1.735	1/8	TP1709
1X2 NOMINAL	1.021	2.015	1/8	TT2001
	1.011	1.985	3/16	TT2001-1
	1.021	2.015	1/8	TP2001
	1.011	1.985	3/16	TP2001-1
1X2-7/8 NOMINAL	1.0205	2.890	1/8	TT2800
	1.0105	2.860		
	1.0205	2.890	1/8	TP2800
	1.0105	2.860		
1-1/16X2-3/8 NOMINAL	1.0675	2.390	1/16	TT2301-4
	1.0575	2.360	1/8	TT2301-3
	1.0675	2.390	1/16	TP2301-4
	1.0575	2.360	1/8	TP2301-3
1-1/8X1-7/8 NOMINAL	1.145	1.890	1/8	TT1800-1
	1.135	1.860		
	1.145	1.890	1/8	TP1800-1
	1.135	1.860		
1-1/4X1-11/16 NOMINAL	1.258	1.705	1/8	TT1602
	1.248	1.675		
	1.258	1.705	1/8	TP1602
	1.248	1.675		
1-1/4X2 NOMINAL	1.270	2.015	1/16	TT2006
	1.260	1.985	1/8	TT2006-1
	1.270	2.015	1/16	TP2006
	1.260	1.985	1/8	TP2006-1
1-1/4X2-3/8 NOMINAL	1.270	2.390	1/16	TT2304-1
	1.260	2.360	1/8	TT2304-2
	1.270	2.390	1/16	TP2304-1
	1.260	2.360	1/8	TP2304-2
1-1/4X3-5/16 NOMINAL	1.260	3.332	1/16	TT3301
	1.250	3.292	1/8	TT3301-1
	1.260	3.332	1/16	TP3301
	1.250	3.292	1/8	TP3301-1
1-3/8X1-15/16 NOMINAL	1.389	1.955	1/8	TT1900
	1.369	1.925		
	1.389	1.955	1/8	TP1900
	1.369	1.925		
1-1/2X2 NOMINAL	1.513	2.015	1/8	TT2008
	1.493	1.985		
	1.513	2.015	1/8	TP2008
	1.493	1.985		
1-1/2X2-1/2 NOMINAL	1.514	2.520	1/8	TT2005
	1.504	2.490		
	1.514	2.520	1/8	TP2005
	1.504	2.490		
1-1/2X3-1/2 NOMINAL	1.520	3.520	3/16	TT3500-1
	1.500	3.480		
	1.520	3.520	3/16	TP3500-1
	1.500	3.480		
1-9/16X2-7/16 NOMINAL	1.588	2.4525	1/8	TT2402
	1.568	2.4225		
	1.588	2.4525	1/8	TP2402
	1.568	2.4225		

	ID	OD	THICKNESS	PART NO.
1-5/8X2-5/8 NOMINAL	1.650	2.640	1/8	TT2602
	1.630	2.610		
	1.650	2.640	1/8	TP2602
	1.630	2.610		
1-3/4X2-7/16 NOMINAL	1.765	2.455	1/8	TT2400-1
	1.745	2.425		
	1.765	2.455	1/8	TP2400-1
	1.745	2.425		
1-3/4X2-5/8 NOMINAL	1.775	2.640	1/8	TT2601
	1.755	2.610		
	1.775	2.640	1/8	TP2601
	1.755	2.610		
1-15/16X2-5/8 NOMINAL	1.963	2.640	1/8	TT2600
	1.943	2.610		
	1.963	2.640	1/8	TP2600
	1.943	2.610		
2X3 NOMINAL	2.021	3.015	1/8	TT3001-3
	2.001	2.985	3/16	TT3001
			1/4	TT3001-1
	2.021	3.015	1/8	TP3001-3
	2.001	2.985	3/16	TP3001
			1/4	TP3001-1
2X3-5/8 NOMINAL	2.041	3.645	3/16	TT3600
	2.021	3.605		
	2.041	3.645	3/16	TP3600
	2.021	3.605		
2X4 NOMINAL	2.072	4.020	1/8	TT4002-1
	2.052	3.980	1/4	TT4002
	2.072	4.020	1/8	TP4002-1
	2.052	3.980	1/4	TP4002
2-1/2X3-1/4 NOMINAL	2.512	3.270	1/8	TT3200
	2.492	3.230		
	2.512	3.270	1/8	TP3200
	2.492	3.230		
2-3/4X3-7/8 NOMINAL	2.781	3.895	1/4	TT3800
	2.751	3.855		
	2.781	3.895	1/4	TP3800
	2.751	3.855		

Note: The "TP-" prefix indicates Oilite Plus.



CORED BAR STOCK

6-1/2" LENGTHS
Will finish to dimensions shown.

ID	OD	PART NO.	
1/2	1	CC1000-2	
	1-1/8	CC1103	
	1-1/4	CC1203	
	1-1/2	CC1502	
	2	CC2005	
5/8	1	CC1001	
	1-1/8	CC1101-1	
	1-1/4	CC1200-1	
	1-3/8	CC1302	
	1-1/2	CC1503	
	1-3/4	CC1703	
	2	CC2006	
	3/4	CC1201-1	
1-1/8	1-1/4	CC1500-1	
	1-1/2	CC1702	
	1-3/4	CC2001	
	2	CC2206	
	2-1/4	CC2504	
	2-1/2	CC2704	
	2-3/4	CC2704	
	7/8	CC1301	
1-1/4	1-1/2	CC1501	
	1-5/8	CC1600-1	
	1-3/4	CC1700-2	
	2	CC2002	
	2-1/4	CC2202-2	
	2-1/2	CC2501	
	3	CC3001	
	3-1/2	CC3504	
1-1/2	4	CC4004	
	2-1/8	CC2102	
	1-1/4	1-3/4	CC1701-3
		2	CC2000-1
		2-1/4	CC2203
		2-1/2	CC2502
		3	CC3003
	1-3/8	3-1/2	CC3505
4		CC4005	
2		CC2003	
1-1/2	2-3/4	CC2702	
	2	CC2004	
	2-1/4	CC2200-1	
	2-1/2	CC2503	
	2-3/4	CC2701	
	3	CC3002	
	3-1/2	CC3502	
	4	CC4007	
1-3/4	2-1/4	CC2201-3	
	2-1/2	CC2500-1	
	2-5/8	CC2604	
	2-3/4	CC2703	
	3	CC3005	
	3-1/2	CC3503	
	4-1/4	CC4202	
	4-1/2	CC4502	

ID	OD	PART NO.
2	2-3/4	CC2700-1
	3	CC3000
	3-1/4	CC3201-2
	4	CC4003
	4-1/2	CC4501
2-1/4	5	CC5000
	5-1/2	CC5500
	3	CC3006
	3-1/4	CC3202-1
	3-1/2	CC3500-1
2-3/8	3-3/4	CC3703
	4	CC4008
	4-1/2	CC4503
	3	CC3007
	3-1/2	CC3507
2-1/2	4	CC4009
	4-1/2	CC4504
	3-1/2	CC3501
	3-3/4	CC3702
	4	CC4010
2-3/4	4-1/4	CC4203
	4-1/2	CC4505
	5	CC5001
	3-3/4	CC3700-1
	3	CC3701-1
3-1/4	4	CC4001
	4-1/2	CC4506
	5	CC5002
	6	CC6000
	9	CC9001
3-1/2	4-1/4	CC4200-1
	4-3/4	CC4700-2
	5	CC5003
	6	CC6002
	5	CC5004
4	5-1/2	CC5501
	6	CC6001
	7	CC7001
	8	CC8000
	6	CC6003
5	7	CC7000
	8	CC8001

Specifications subject to change without notice

SOLID BAR STOCK

6-1/2" LENGTHS
Will finish to dimensions shown.

DIAMETER	PART NO.
1/4	*BB200
3/8	**BB302
1/2	BB500
5/8	BB600-1
3/4	BB700-1
7/8	BB800-1
1	BB1000-2
1-1/8	BB1100
1-1/4	BB1200-1
1-3/8	BB1300
1-1/2	BB1500-2
1-5/8	BB1600
1-3/4	BB1700-1
2	BB2000-1
2-1/4	BB2200
2-1/2	BB2500-1
2-3/4	BB2700-1
3	BB3000-1
3-1/4	BB3200-2
3-1/2	BB3500-1
4	BB4000-1
4-1/2	BB4500
5	BB5000
5-1/2	BB5500
6	BB6000
7	BB7000
8	BB8000

* LENGTH - 2"
** LENGTH - 3"

PLATE STOCK

WIDTH AND LENGTH —
Will finish to dimensions shown.

WIDTH	LENGTH	*THICKNESS	PART NO.
1/2	2-1/2	1/4	PP2500
1-1/8	3-1/8	3/16	PP3100
2	8-1/8	1/4	PP8100-1
		1/2	PP8100
3	12	1/4	PP12100
		1/2	PP12100-1
		3/4	PP12100-2
5	6	1	PP12100-3
		1/8	PP6000
		3/16	PP6000-1
5	8	1/4	PP6000-2
		3/8	PP6000-4
		1/2	PP6000-5
		5/8	PP6000-6
		3/4	PP6000-7
		1	PP6000-8
		1/8	PP8000-7
		3/16	PP8000
6	12	1/4	PP8000-1
		1/2	PP8000-4
		3/4	PP8000-5
		1	PP8000-6
		1/8	PP12000-6
		3/16	PP12000-7
		1/4	PP12000
		3/8	PP12000-1
6	12	1/2	PP12000-2
		5/8	PP12000-3
		3/4	PP12000-4
		1	PP12000-5

* THICKNESS - +0.010/-0.005"

CIRCULAR BEARING PLATES-DISCS

OILITE BRONZE
ID and OD will finish to dimensions shown.

ID	OD	THICKNESS ±.0025"	PART NO.
1	3	1/4	CD-3001
	4	1/4	CD4001
2	4	1/4	CD4002
	5-1/2	1/4*	CD5500
2.25	4-1/2	1/4	CD4502
4	6	5/16*	CD6003
SOLID	3	1/4	DD3000
	3	3/8	DD3000-1
	4	1/4	DD4000
	5-5/8	1/4*	DD5602-1

* THICKNESS ±.0035"

Oilite® M Series®

METRIC SLEEVE BEARINGS

	ID (mm)	OD (mm)	LENGTH (mm)	PART NO.
3 X 6	3.020	6.040	4	AAM0306-04
NOMINAL	3.000	6.020	6	AAM0306-06
			10	AAM0306-10
4 X 7	4.020	7.040	4	AAM0407-04
NOMINAL	4.000	7.020	8	AAM0407-08
4 X 8	4.020	8.040	3	AAM0408-03
NOMINAL	4.000	8.020	4	AAM0408-04
			6	AAM0408-06
			8	AAM0408-08
5 X 8	5.020	8.040	4	AAM0508-04
NOMINAL	5.000	8.020	5	AAM0508-05
			8	AAM0508-08
			10	AAM0508-10
			16	AAM0508-16
6 X 9	6.020	9.040	4	AAM0609-04
NOMINAL	6.000	9.020	6	AAM0609-06
			8	AAM0609-08
			10	AAM0609-10
			12	AAM0609-12
			16	AAM0609-16
6 X 10	6.020	10.040	4	AAM0610-04
NOMINAL	6.000	10.020	6	AAM0610-06
			10	AAM0610-10
			12	AAM0610-12
			16	AAM0610-16
6 X 12	6.020	12.050	6	AAM0612-06
NOMINAL	6.000	12.030	10	AAM0612-10
			12	AAM0612-12
8 X 11	8.030	11.050	6	AAM0811-06
NOMINAL	8.010	11.030	8	AAM0811-08
			12	AAM0811-12
8 X 12	8.030	12.050	6	AAM0812-06
NOMINAL	8.010	12.030	8	AAM0812-08
			12	AAM0812-12
			16	AAM0812-16
			20	AAM0812-20
8 X 14	8.030	14.050	8	AAM0814-08
NOMINAL	8.010	14.030	12	AAM0814-12
			16	AAM0814-16
			20	AAM0814-20
10 X 13	10.030	13.050	10	AAM1013-10
NOMINAL	10.010	13.030	16	AAM1013-16
10 X 14	10.030	14.050	8	AAM1014-08
NOMINAL	10.010	14.030	10	AAM1014-10
			14	AAM1014-14
			16	AAM1014-16
			25	AAM1014-25
10 X 16	10.030	16.050	10	AAM1016-10
NOMINAL	10.010	16.030	16	AAM1016-16
			25	AAM1016-25
12 X 15	12.030	15.050	12	AAM1215-12
NOMINAL	12.010	15.030	16	AAM1215-16
			20	AAM1215-20
			25	AAM1215-25
12 X 16	12.030	16.050	8	AAM1216-08
NOMINAL	12.010	16.030	12	AAM1216-12
			16	AAM1216-16
			20	AAM1216-20
			25	AAM1216-25

	ID (mm)	OD (mm)	LENGTH (mm)	PART NO.
12 X 18	12.030	18.050	8	AAM1218-08
NOMINAL	12.010	18.030	10	AAM1218-10
			12	AAM1218-12
			16	AAM1218-16
			20	AAM1218-20
			25	AAM1218-25
14 X 20	14.030	20.060	10	AAM1420-10
NOMINAL	14.010	20.040	12	AAM1420-12
			14	AAM1420-14
			20	AAM1420-20
			30	AAM1420-30
15 X 19	15.030	19.060	10	AAM1519-10
NOMINAL	15.010	19.040	15	AAM1519-15
			16	AAM1519-16
			20	AAM1519-20
			25	AAM1519-25
15 X 20	15.030	20.060	15	AAM1520-15
NOMINAL	15.010	20.040	20	AAM1520-20
			25	AAM1520-25
15 X 22	15.030	22.060	15	AAM1522-15
NOMINAL	15.010	22.040	20	AAM1522-20
			25	AAM1522-25
16 X 20	16.030	20.060	16	AAM1620-16
NOMINAL	16.010	20.040	20	AAM1620-20
			25	AAM1620-25
			30	AAM1620-30
16 X 22	16.030	22.060	16	AAM1622-16
NOMINAL	16.010	22.040	20	AAM1622-20
			25	AAM1622-25
18 X 22	18.030	22.060	18	AAM1822-18
NOMINAL	18.010	22.040	22	AAM1822-22
			28	AAM1822-28
			30	AAM1822-30
18 X 25	18.030	25.060	18	AAM1825-18
NOMINAL	18.010	25.040	22	AAM1825-22
			28	AAM1825-28
			30	AAM1825-30
20 X 24	20.030	24.060	16	AAM2024-16
NOMINAL	20.010	24.040	20	AAM2024-20
			25	AAM2024-25
			32	AAM2024-32
20 X 25	20.030	25.060	15	AAM2025-15
NOMINAL	20.010	25.040	16	AAM2025-16
			20	AAM2025-20
			25	AAM2025-25
			30	AAM2025-30
20 X 26	20.030	26.060	20	AAM2026-20
NOMINAL	20.010	26.040	30	AAM2026-30
20 X 28	20.030	28.060	16	AAM2028-16
NOMINAL	20.010	28.030	20	AAM2028-20
			25	AAM2028-25
22 X 27	22.030	27.060	22	AAM2227-22
NOMINAL	22.010	27.040	28	AAM2227-28
22 X 28	22.030	28.060	20	AAM2228-20
NOMINAL	22.010	28.040	22	AAM2228-22
			30	AAM2228-30
25 X 30	25.030	30.060	20	AAM2530-20
NOMINAL	25.010	30.040	25	AAM2530-25
			28	AAM2530-28

	ID (mm)	OD (mm)	LENGTH (mm)	PART NO.
25 X 30	25.030	30.060	30	AAM2530-30
NOMINAL	25.010	30.060	32	AAM2530-32
(CONT.)			50	AAM2530-50
25 X 32	25.030	32.070	20	AAM2532-20
NOMINAL	25.010	32.040	25	AAM2532-25
			32	AAM2532-32
			40	AAM2532-40
25 X 35	25.030	35.070	25	AAM2535-25
NOMINAL	25.010	35.040	35	AAM2535-35
28 X 32	28.030	32.070	22	AAM2832-22
NOMINAL	28.010	32.040	28	AAM2832-28
28 X 33	28.030	33.070	22	AAM2833-22
NOMINAL	28.010	33.040	28	AAM2833-28
			30	AAM2833-30
28 X 36	28.030	36.070	22	AAM2836-22
NOMINAL	28.010	36.040	28	AAM2836-28
			40	AAM2836-40
30 X 38	30.030	38.070	24	AAM3038-24
NOMINAL	30.010	38.040	30	AAM3038-30
			40	AAM3038-40
30 X 40	30.030	40.070	25	AAM3040-25
NOMINAL	30.010	40.040	30	AAM3040-30
			50	AAM3040-50
32 X 40	32.040	40.070	20	AAM3240-20
NOMINAL	32.010	40.040	25	AAM3240-25
			32	AAM3240-32
35 X 44	35.040	44.070	22	AAM3544-22
NOMINAL	35.010	44.040	28	AAM3544-28
			35	AAM3544-35
35 X 45	35.040	45.070	25	AAM3545-25
NOMINAL	35.010	45.040	30	AAM3545-30
			35	AAM3545-35
			50	AAM3545-50
40 X 50	40.040	50.070	25	AAM4050-25
NOMINAL	40.010	50.040	30	AAM4050-30
			35	AAM4050-35
			40	AAM4050-40
			60	AAM4050-60
45 X 55	45.040	55.080	35	AAM4555-35
NOMINAL	45.010	55.050	40	AAM4555-40
			45	AAM4555-45
			50	AAM4555-50
			55	AAM4555-55
45 X 56	45.040	56.080	35	AAM4556-35
NOMINAL	45.010	56.050	50	AAM4556-50
			56	AAM4556-56
50 X 60	50.040	60.080	35	AAM5060-35
NOMINAL	50.010	60.050	50	AAM5060-50
			63	AAM5060-63
			70	AAM5060-70
			75	AAM5060-75

Oilite® M Series®

METRIC FLANGE BEARINGS

	ID (mm)	OD (mm)	LENGTH (mm)	FLANGE OD (mm)	FLANGE THK. (mm)	PART NO.
3 X 6	3.020	6.040	4	9	1.5	FFM0306-04
NOMINAL	3.000	6.020	6			FFM0306-06
4 X 7	4.020	7.040	6	10	1.5	FFM0407-06
NOMINAL	4.000	7.020	10			FFM0407-10
5 X 8	5.020	8.040	5	11	1.5	FFM0508-05
NOMINAL	5.000	8.020	6			FFM0508-06
			10			FFM0508-10
6 X 9	6.020	9.040	5	12	1.5	FFM0609-05
NOMINAL	6.000	9.020	6			FFM0609-06
			10			FFM0609-10
			12			FFM0609-12
6 X 10	6.020	10.040	4	14	2	FFM0610-04
NOMINAL	6.000	10.020	6			FFM0610-06
			10			FFM0610-10
			16			FFM0610-16
8 X 11	8.030	11.050	6	14	1.5	FFM0811-06
NOMINAL	8.010	11.030	10			FFM0811-10
			12			FFM0811-12
8 X 12	8.030	12.050	8	16	2	FFM0812-08
NOMINAL	8.010	12.030	12			FFM0812-12
			16			FFM0812-16
10 X 13	10.030	13.050	6	16	1.5	FFM1013-06
NOMINAL	10.010	13.030	8			FFM1013-08
			10			FFM1013-10
			12			FFM1013-12
			16			FFM1013-16
			20			FFM1013-20
10 X 16	10.030	16.050	8	22	3	FFM1016-08
NOMINAL	10.010	16.030	10			FFM1016-10
			12			FFM1016-12
			16			FFM1016-16
12 X 15	12.030	15.050	8	18	1.5	FFM1215-08
NOMINAL	12.010	15.030	10			FFM1215-10
			12			FFM1215-12
			16			FFM1215-16
			20			FFM1215-20
12 X 17	12.030	17.050	12	23	3	FFM1217-12
NOMINAL	12.010	17.030	16			FFM1217-16
			20			FFM1217-20
			25			FFM1217-25
12 X 18	12.030	18.050	8	24	3	FFM1218-08
NOMINAL	12.010	18.030	10			FFM1218-10
			12			FFM1218-12
			16			FFM1218-16
			20			FFM1218-20
14 X 18	14.030	18.050	12	22	2	FFM1418-12
NOMINAL	14.010	18.030	20			FFM1418-20
			22			FFM1418-22
14 X 20	14.030	20.050	10	26	3	FFM1420-10
NOMINAL	14.010	20.030	14			FFM1420-14
			18			FFM1420-18
			20			FFM1420-20
15 X 19	15.030	19.060	12	23	2	FFM1519-12
NOMINAL	15.010	19.040	20			FFM1519-20
			25			FFM1519-25

	ID (mm)	OD (mm)	LENGTH (mm)	FLANGE OD (mm)	FLANGE THK. (mm)	PART NO.
16 X 20	16.030	20.060	12	24	2	FFM1620-12
NOMINAL	16.010	20.040	16			FFM1620-16
			20			FFM1620-20
			25			FFM1620-25
16 X 22	16.030	22.060	12	28	3	FFM1622-12
NOMINAL	16.010	22.040	16			FFM1622-16
			20			FFM1622-20
			25			FFM1622-25
18 X 22	18.030	22.060	12	26	2	FFM1822-12
NOMINAL	18.010	22.040	18			FFM1822-18
			20			FFM1822-20
			25			FFM1822-25
20 X 24	20.030	24.060	12	28	2	FFM2024-12
NOMINAL	20.010	24.040	16			FFM2024-16
			20			FFM2024-20
			25			FFM2024-25
			30			FFM2024-30
20 X 26	20.030	26.060	12	32	3	FFM2026-12
NOMINAL	20.010	26.040	16			FFM2026-16
			20			FFM2026-20
			25			FFM2026-25
			30			FFM2026-30
22 X 28	22.030	28.060	16	34	3	FFM2228-16
NOMINAL	22.010	28.040	20			FFM2228-20
			25			FFM2228-25
25 X 30	25.030	30.060	20	39	3.5	FFM2530-20
NOMINAL	25.010	30.040	25			FFM2530-25
			30			FFM2530-30
			32			FFM2530-32
25 X 32	25.030	32.060	20	39	3	FFM2532-20
NOMINAL	25.010	32.040	25			FFM2532-25
			30			FFM2532-30
30 X 38	30.030	38.070	20	46	4	FFM3038-20
NOMINAL	30.010	38.040	25			FFM3038-25
			30			FFM3038-30
32 X 38	32.040	38.070	20	46	4	FFM3238-20
NOMINAL	32.010	38.040	25			FFM3238-25
			32			FFM3238-32
35 X 40	35.040	40.070	25	45	2.5	FFM3540-25
NOMINAL	35.010	40.040	32			FFM3540-32
40 X 46	40.040	46.070	20	56	5	FFM4046-20
NOMINAL	40.010	46.040	25			FFM4046-25
			32			FFM4046-32
			40			FFM4046-40
45 X 51	45.040	51.080	25	57	3	FFM4551-25
NOMINAL	45.010	51.050	32			FFM4551-32
50 X 60	50.040	60.080	32	70	5	FFM5060-32
NOMINAL	50.010	60.050	35			FFM5060-35
			40			FFM5060-40
			50			FFM5060-50



Super Oilite[®]
BEARINGS



oilite[®]

SLEEVE BEARINGS

	ID	OD	LENGTH	PART NO.
1/4X5/16	.252	.314	1/4	SOA334-1
NOMINAL	.251	.313	3/8	SOA334-2
			1/2	SOA334-3
1/4X3/8	.252	.377	1/4	SOA307
NOMINAL	.251	.376	3/8	SOA307-9
			1/2	SOA307-3
			3/4	SOA307-11
			1	SOA307-2
3/8X1/2	.3765	.503	1/4	SOA507-19
NOMINAL	.3755	.502	3/8	SOA507-11
			1/2	SOA507-10
			3/4	SOA507-2
			1	SOA507-23
1/2X5/8	.502	.628	3/8	SOA632-1
NOMINAL	.501	.627	1/2	SOA632-2
			5/8	SOA632-3
			3/4	SOA632-4
			1	SOA632-6
			1-1/2	SOA632-12

	ID	OD	LENGTH	PART NO.
1/2X3/4	.5025	.753	1/2	SOA744-5
NOMINAL	.5015	.752	3/4	SOA744-4
			1	SOA744-3
			1-1/2	SOA744-1
5/8X3/4	.628	.753	1/2	SOA710-27
NOMINAL	.627	.752	5/8	SOA710-19
			3/4	SOA710-6
			1	SOA710-3
			1-1/2	SOA710-12
3/4X1	.753	1.003	1/2	SOA1043-1
NOMINAL	.752	1.002	3/4	SOA1043-6
			1	SOA1043-9
			1-1/4	SOA1043
			1-1/2	SOA1043-4
1X1-1/4	1.003	1.253	1/2	SOA1232-1
NOMINAL	1.002	1.252	3/4	SOA1232-6
			1	SOA1232
			1-1/4	SOA1232-3
			1-1/2	SOA1232-7
			1-3/4	SOA1232-8
			2	SOA1232-4

	ID	OD	LENGTH	PART NO.
1-1/4X1-1/2	1.253	1.504	3/4	SOA1524-2
NOMINAL	1.2515	1.5025	1	SOA1524-3
			1-1/4	SOA1524-4
			1-1/2	SOA1524-5
			1-3/4	SOA1524-11
			2	SOA1524-13
1-1/2X1-3/4	1.503	1.7545	3/4	SOA1704-16
NOMINAL	1.501	1.7525	1	SOA1704-15
			1-1/4	SOA1704-11
			1-1/2	SOA1704
			1-3/4	SOA1704-3
			2	SOA1704-2

FLANGE BEARINGS

	ID	OD	LENGTH	FLANGE OD	FLANGE THICKNESS	PART NO.
1/4X3/8	.252	.377	1/4	1/2	1/16	SOF317-1
NOMINAL	.251	.376	3/8			SOF317-2
			1/2			SOF317-3
5/16X7/16	.3135	.440	3/8	9/16	1/16	SOF411-1
NOMINAL	.3125	.439	1/2			SOF411-2
			3/4			SOF411-3
			7/8			SOF411-4
3/8X1/2	.377	.503	1/4	11/16	1/16	SOF318-1
NOMINAL	.376	.502	1/2			SOF318-2
			3/4			SOF318-3
3/8X5/8	.377	.628	1/2	7/8	1/16	SOF319-1
NOMINAL	.376	.627	3/4			SOF319-2
			1			SOF319-3
1/2X5/8	.502	.627	3/8	7/8	1/8	SOF611-1
NOMINAL	.501	.626	1/2			SOF611-2
			5/8			SOF611-3
			3/4			SOF611-4
			1			SOF611-6
1/2X3/4	.503	.753	1/2	1	1/8	SOF621-1
NOMINAL	.502	.752	3/4			SOF621-3
			1			SOF621-4
5/8X3/4	.626	.753	1/2	1	1/8	SOF711-1
NOMINAL	.625	.752	5/8			SOF711-2
			3/4			SOF711-3
			1			SOF711-4
3/4X7/8	.751	.879	1/2	1-1/8	1/8	SOF854-1
NOMINAL	.750	.878	3/4			SOF854-2
			1			SOF854-3
3/4X1	.752	1.004	5/8	1-1/4	3/16	SOF1016-1
NOMINAL	.751	1.003	3/4			SOF1016-2
			1			SOF1016-3
			1-1/4			SOF1016-4
1X1-1/4	1.001	1.252	3/4	1-1/2	1/8	SOF1213-1
NOMINAL	1.000	1.251	1			SOF1213-2
			1-1/4			SOF1213-3
			1-1/2			SOF1213-4

THRUST BEARINGS

	ID	OD	THICKNESS	PART NO.
1/4X5/8	.256	.629	1/16	SOT601
NOMINAL	.246	.609		
3/8X3/4	.391	.751	1/16	SOT710-1
NOMINAL	.381	.731	1/8	SOT710-2
1/2X3/4	.510	.760	1/16	SOT706
NOMINAL	.500	.740		
1/2X1	.510	.999	1/16	SOT1001
NOMINAL	.500	.979	1/8	SOT1001-1
5/8X1	.629	.999	1/16	SOT1002-1
NOMINAL	.619	.979	1/8	SOT1002
3/4X1-1/4	.752	1.246	1/16	SOT1205
NOMINAL	.742	1.226	1/8	SOT1205-1
3/4X1-3/4	.762	1.740	1/8	SOT1701
NOMINAL	.752	1.720		
1X1-1/2	1.000	1.494	1/16	SOT1502-2
NOMINAL	.990	1.474	1/8	SOT1502
			3/16	SOT1502-1
1X2	1.013	1.993	1/8	SOT2001
NOMINAL	1.003	1.973	3/16	SOT2001-1
1-1/4X2	1.262	1.993	1/16	SOT2006
NOMINAL	1.252	1.973	1/8	SOT2006-1
1-1/2X2-1/2	1.512	2.516	1/8	SOT2005
NOMINAL	1.502	2.496		

SUPER OILITE BAR STOCK

Super-Oilite is an oil cushioned, self-lubricating bearing material with a ferrous base. Therefore it is somewhat stronger than OILITE bronze—especially for heavy loading at slow speeds—and considerably more economical. Its overall rating, however, is not as high as OILITE bronze for general bearing purposes. It is available in both cored and solid bar stock which can be machined for emergency repairs, prototypes and new design requirements.

CORED

5" LENGTHS

Will finish to dimensions shown.

ID	OD	PART NO.
1/2	1	SSC1000
	1-7/16	SSC1402
3/4	1-3/16	SSC1102
	1-9/16	SSC1500
	1-15/16	SSC1900
1	1-11/16	SSC1601
	2-3/16	SSC2100
1-1/4	1-11/16	SSC1602
	2-3/16	SSC2103
	2-7/8	SSC2803
1-1/2	1-15/16	SSC1904
1-3/4	2-1/2	SSC2504
	3	SSC3004
2	2-5/8	SSC2600
	3	SSC3005
2-1/2	3-3/8	SSC3301
	4-1/8	SSC4102
3	4-7/8	SSC4802

SOLID

5" LENGTHS

Will finish to dimensions shown.

DIAMETER	PART NO.
3/8	SSS300†
1/2	SSS500††
5/8	SSS600
3/4	SSS700
7/8	SSS800
1	SSS1000
1-3/16	SSS1100
1-5/16	SSS1300
1-9/16	SSS1500
1-13/16	SSS1800
2-1/16	SSS2000
2-7/8	SSS2800

† LENGTH – 3"

†† LENGTH – 6-1/2"



Excelite TX[®]
BEARINGS



oilite[®]

Excelite TX®

THE SYSTEM

Excelite TX. A unique bearing combining proven materials with a three-tiered, self-contained lubrication feature. This bearing was developed for high load, low speed application and is ideally suited for all types of rotating and oscillating motion. Additional lubrication introduced to the bearing where necessary can further performance.

THE ADVANTAGE

Excelite TX has many cost saving benefits in addition to its performance features. Unlike composite or strip bearings, Excelite TX's entire wall thickness is made of the bearing material. Standard sizes listed are arranged to be compatible with standard cast bronze bushings and are designed to be installed without subsequent sizing operations. The Excelite TX Advantage...versatility of design and cost reduction.

THE APPLICATIONS

- Agricultural Equipment
- Glass Processing Machines
- Golf and Lawn Vehicles
- Material Handling Trucks
- Earth Moving Equipment
- Paper and Textile Machines
- Cable Handling Equipment
- Construction Cranes
- Packaging Machines
- Hoisting Devices
- Hydraulic Cylinders
- Printing Presses
- Filling Equipment
- Valves

EXCELITE DTX®

Excelite DTX has grease pockets on the bearing surface. These pockets can store lubricants generated directly from the bearing itself or those introduced externally. These same pockets can also provide a place for foreign contaminants to collect and thus prolong bearing life. Consult our sales engineers for additional application and design information.

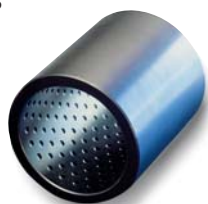

EXCELITE HTX®

This self-lubricating material is the extreme duty Excelite bearing material ideally suited for the most demanding applications. Shafting used against Excelite HTX should be Rockwell 45C or higher, and the best possible finish should be maintained. Excelite HTX bearings are available in the sizes listed in the Excelite TX section.

GENERAL CHARACTERISTICS

LOADS AND SPEEDS

The best method for evaluating the acceptability of Excelite TX bearings for any given application is by using PV factor (Pressure x Surface Velocity) where:

P = the load in (psi) on the projected bearing area (Bearing ID x Length).

V = surface velocity of the shaft in feet per minute (SFM).

$$PV = \frac{W}{LD} \times \frac{\pi DN}{12} = \frac{3.14 WN}{12L}$$

W = total load on bearing (pounds)

L = bearing length (inches)

D = ID of bearing (inches)

N = shaft speed (rpm)

MATERIAL	NORMAL UPPER LIMITS FOR EXCELITE MATERIALS			V (sfm)
	PV	P (psi) STATIC	P (psi) DYNAMIC	
EXCELITE TX	40,000	25,000	5,000	220
EXCELITE HTX	70,000	40,000	7,500	40

BP3⁺ MOLYBDENUM DISULFIDE

CHARACTERISTICS	HIGH FILM STRENGTH
VISCOSITY (SUS) @100°F	2420
@210°F	141
VISCOSITY INDEX	90
FLASH POINT (°F)	460
FIRE POINT (°F)	525
POUR POINT (°F)	+10
SAE EQUIV. (VISCOSITY)	130 (EP)**

BP3⁺ and Moly has an extremely stable suspension of uniform microscopic Molybdenum Disulfide particles. As an additive Molybdenum Disulfide substantially improves the extreme pressure, anti-wear, and anti-friction capabilities of oils and provides reliable lubrication in those demanding applications that approach boundary lubrication conditions.

** EXTREME PRESSURE

TYPICAL PROPERTIES*

PROPERTIES	EXCELITE TX	EXCELITE HTX
Component Percent		
COPPER	19.0 - 23.0	19.0 - 23.0
IRON	BALANCE	BALANCE
LEAD	—	—
CARBON	.3 - .6	.8 - 1.0
TIN	—	—
ACID INSOLUBLES (MAX)	—	—
MAGNESIUM	—	—
TOTAL OTHER ELEMENTS (MAX.)	2.5	2.5
BALANCE	—	—

Physical & Mechanical Properties

DENSITY (GM PER CU. CM)	5.9 - 6.3	6.2 - 6.6
POROSITY (% OIL BY VOL.)	18 MIN.	15 MIN.
"K" STRENGTH CONSTANT	50,000	75,000
TENSILE STRENGTH	30,000	40,000
ELONGATION (% IN ONE INCH)	2%	1%
YIELD STRENGTH IN COMP. (PSI)**	30,000	45,000

* Bearings may exhibit appreciable differences in properties due to size, shape, thickness, etc.

** For .001" permanent set on test specimens 1-1/4" diameter by 1" long.

Excelite materials may be altered due to operation conditions and life expectancy requirements. It is possible to change the base material by heat treating or alloy change. It is also possible to vary the lubricant specs or add grooving. Changing the fluorocarbon coating is also done.

NO "BREAK IN"

Excelite TX virtually eliminates "break in" because of the PTFE coating applied to the bearing surface providing low coefficient of friction for start up.

LONG LIFE

As long as load rating and maximum speed rates are adhered to, Excelite TX can provide good life expectancy. The PTFE coating lasts far beyond "break in", and the fully impregnated P/M under infrastructure takes over to provide expected life.

PTFE VALUES

PROPERTY	"PTFE" VALUE
TENSILE STRENGTH @ 77°F (psi) @ 25°C (kg/cm ²)	3,000 - 13,600 200 - 920
ELONGATION @ 77°F/25°C (percent)	1 - 9
STATIC COEFFICIENT OF FRICTION AGAINST POLISHED STEEL	0.15
DIELECTRIC STRENGTH, SHORT TIME, 4 MIL FIL (volts/mil) 100 MICRON FILM (volts/micron)	400 - 1400 20 - 100
DIELECTRIC CONSTANT @ 10 ⁶ cycles/sec	1.2 - 600
DISSIPATION FACTOR @ 10 ⁶ cycles/sec	0.002 - 1.0
VOLUME RESISTIVITY, 50% RELATIVE HUMIDITY (ohm-cm)	10 ¹¹ - 10 ¹³
SURFACE RESISTIVITY, 50% RELATIVE HUMIDITY (ohms)	10 ⁸ - 10 ¹³
WATER ABSORPTION (percent)	<2 TO <4
USE TEMPERATURE	-50°F TO +450°F -45°F TO +232°C
RESISTANCE TO ABRASION: GRAMS ABRASIVE PER MIL TEST METHOD: BELL ABRASION TESTER	30 - 50 1.2 - 2.0
HARDNESS: TUKON HARDNESS TEST (knoops) SWARD ROCKER TEST	9 - 18 46 - 62
CONTACT ANGLE (degrees): WATER HEXADECANE	80 - 110 30 - 50

The values shown in this table represent average experience from numerous testing sources and are not intended to be specifications. These values will vary depending upon the individual compositions of the primers and topcoats and the systems used. All technical advice recommendations, application suggestions and services are rendered by the Seller gratis. They are based on technical data which the seller believes to be reliable and are intended for use by persons having skill and know how at their own discretion and risk. Seller assumes no responsibility for results obtained or damages incurred from their use by Buyer in whole or in part.

INSTALLATION and SIZING

Bearings are usually installed by means of a shouldered arbor plug inserted in an arbor press. (See chart of press fit values below.) A chamfer in the housing bore is necessary to serve as a lead for the bearing. An unchamfered edge might shear metal from the bearing OD, seriously reducing the

press fit. The OD on the lead end of the bearing acts as a pilot. Likewise, the ID chamfer in the bearings serves as a lead when the shaft is inserted. Out-of-roundness is corrected when the bearing is pressed into the housing.

PRESS FIT VALUES / BEARING CLEARANCE / ID CLOSE-IN

PRESS FIT VALUES

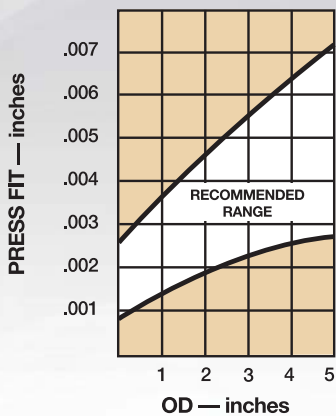

Considerable force is required to seat large bearings when press fit approaches the top of the recommended range. Excelite TX bearings can tolerate these press fits and are necessary to keep the bearings secure in the housing.

BEARING CLEARANCE

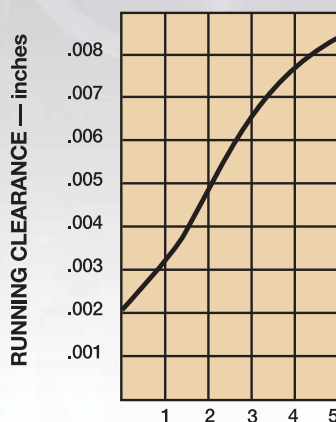

ID CLOSE-IN

As related to wall thickness (Approximate Values) for Normal Press Fit

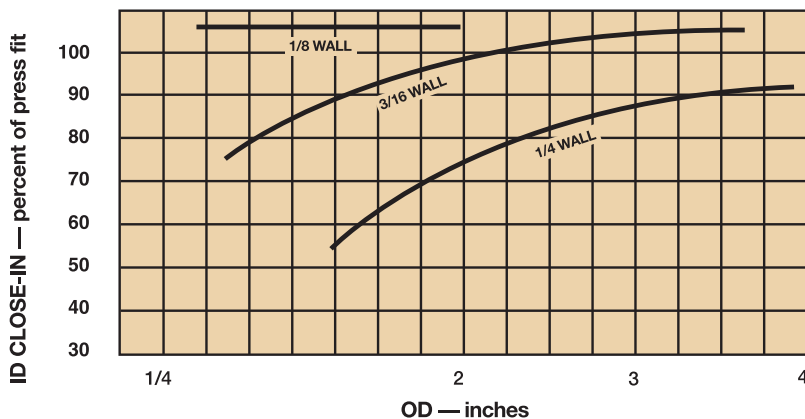

Excelite TX[®]

SLEEVE BEARINGS

	ID	OD	LENGTH	PART NO.
	1/2 X 5/8	.5055	.628	1/2 TX0810-04
NOMINAL	.5045	.627	5/8 TX0810-05	
			3/4 TX0810-06	
			7/8 TX0810-07	
			1 TX0810-08	
	1/2 X 3/4	.5055	.753	3/4 TX0812-06
NOMINAL	.5045	.752	1 TX0812-08	
			1-1/4 TX0812-10	
	5/8 X 3/4	.6285	.753	3/4 TX1012-06
NOMINAL	.6275	.752	1 TX1012-08	
			1-1/4 TX1012-10	
	5/8 X 7/8	.6285	.878	3/4 TX1014-06
NOMINAL	.6275	.877	1 TX1014-08	
			1-1/4 TX1014-10	
			1-1/2 TX1014-12	
			1-3/4 TX1014-14	
	3/4 X 7/8	.7555	.878	3/4 TX1214-06
NOMINAL	.7545	.877	1 TX1214-08	
			1-1/4 TX1214-10	
	3/4 X 1	.7555	1.003	3/4 TX1216-06
NOMINAL	.7545	1.002	1 TX1216-08	
			1-1/4 TX1216-10	
			1-1/2 TX1216-12	
			1-3/4 TX1216-14	
			2 TX1216-16	
	7/8 X 1	.8795	1.003	3/4 TX1416-06
NOMINAL	.8785	1.002	1 TX1416-08	
			1-1/4 TX1416-10	
			1-1/2 TX1416-12	
	7/8 X 1-1/8	.8795	1.128	3/4 TX1418-06
NOMINAL	.8785	1.127	1 TX1418-08	
			1-1/4 TX1418-10	
			1-1/2 TX1418-12	
			1-3/4 TX1418-14	
			2 TX1418-16	
	1 X 1-1/4	1.006	1.253	3/4 TX1620-06
NOMINAL	1.005	1.252	1 TX1620-08	
			1-1/4 TX1620-10	
			1-1/2 TX1620-12	
			1-3/4 TX1620-14	
			2 TX1620-16	
			2-1/4 TX1620-18	
			2-1/2 TX1620-20	
	1 X 1-3/8	1.006	1.3785	3/4 TX1622-06
NOMINAL	1.005	1.377	1 TX1622-08	
			1-1/4 TX1622-10	
			1-1/2 TX1622-12	
			1-3/4 TX1622-14	
			2 TX1622-16	
			2-1/4 TX1622-18	
			2-1/2 TX1622-20	
	1-1/8 X 1-3/8	1.130	1.3785	1 TX1822-08
NOMINAL	1.1285	1.377	1-1/4 TX1822-10	
			1-3/4 TX1822-12	
			2 TX1822-14	
			2-1/4 TX1822-16	
			2-1/2 TX1822-18	
	1-1/4 X 1-1/2	1.2565	1.5035	1 TX2024-08
NOMINAL	1.255	1.502	1-1/4 TX2024-10	
			1-1/2 TX2024-12	

	ID	OD	LENGTH	PART NO.
	1-1/4 X 1-1/2	1.2565	1.5035	1-3/4 TX2024-14
NOMINAL	1.255	1.502	2 TX2024-16	
(CONT.)			2-1/4 TX2024-18	
			2-1/2 TX2024-20	
	1-1/4 X 1-5/8	1.2565	1.6295	1 TX2026-08
NOMINAL	1.255	1.6275	1-1/4 TX2026-10	
			1-1/2 TX2026-12	
			1-3/4 TX2026-14	
			2 TX2026-16	
			2-1/4 TX2026-18	
			2-1/2 TX2026-20	
	1-1/4 X 1-3/4	1.2565	1.7545	1-1/4 TX2028-10
NOMINAL	1.255	1.7525	1-1/2 TX2028-12	
			1-3/4 TX2028-14	
			2 TX2028-16	
			2-1/4 TX2028-18	
			2-1/2 TX2028-20	
			2-3/4 TX2028-22	
			3 TX2028-24	
	1-3/8 X 1-5/8	1.3815	1.6295	1-1/4 TX2226-10
NOMINAL	1.380	1.6275	1-1/2 TX2226-12	
			1-3/4 TX2226-14	
			2 TX2226-16	
			2-1/4 TX2226-18	
			2-1/2 TX2226-20	
	1-3/8 X 1-3/4	1.3815	1.7545	1-1/4 TX2228-10
NOMINAL	1.380	1.7525	1-1/2 TX2228-12	
			1-3/4 TX2228-14	
			2 TX2228-16	
			2-1/4 TX2228-18	
			2-1/2 TX2228-20	
			2-3/4 TX2228-22	
	1-1/2 X 1-3/4	1.508	1.7545	1-1/4 TX2428-10
NOMINAL	1.5065	1.7525	1-1/2 TX2428-12	
			1-3/4 TX2428-14	
			2 TX2428-16	
			2-1/4 TX2428-18	
			2-1/2 TX2428-20	
	1-1/2 X 1-7/8	1.508	1.880	1-1/4 TX2430-10
NOMINAL	1.5065	1.878	1-1/2 TX2430-12	
			1-3/4 TX2430-14	
			2 TX2430-16	
			2-1/4 TX2430-18	
			2-1/2 TX2430-20	
			2-3/4 TX2430-22	
			3 TX2430-24	
	1-1/2 X 2	1.508	2.005	1-1/4 TX2432-10
NOMINAL	1.5065	2.003	1-1/2 TX2432-12	
			1-3/4 TX2432-14	
			2 TX2432-16	
			2-1/4 TX2432-18	
			2-1/2 TX2432-20	
			2-3/4 TX2432-22	
			3 TX2432-24	
			3-1/2 TX2432-28	
	1-5/8 X 2	1.633	2.005	1-1/2 TX2632-12
NOMINAL	1.631	2.003	1-3/4 TX2632-14	
			2 TX2632-16	
			2-1/2 TX2632-18	
	1-3/4 X 2	1.7585	2.005	1-1/2 TX2832-12
NOMINAL	1.7565	2.003	2 TX2832-16	
			2-1/4 TX2832-18	
			2-1/2 TX2832-20	

	ID	OD	LENGTH	PART NO.
	1-3/4 X 2-1/4	1.7585	2.255	1-3/4 TX2836-14
NOMINAL	1.7565	2.253	2 TX2836-16	
			2-1/2 TX2836-20	
			3 TX2836-24	
	2 X 2-1/4	2.008	2.255	2 TX3236-16
NOMINAL	2.006	2.253	2-1/2 TX3236-20	
	2 X 2-3/8	2.008	2.380	2 TX3238-16
NOMINAL	2.006	2.378	2-1/2 TX3238-20	
			3 TX3238-24	
			3-1/2 TX3238-28	
	2-1/4 X 2-1/2	2.258	2.505	2 TX3640-16
NOMINAL	2.256	2.503	2-1/2 TX3640-20	
			3 TX3640-24	
			3-1/2 TX3640-28	
	2-1/4 X 2-3/4	2.258	2.755	2 TX3644-16
NOMINAL	2.256	2.753	2-1/2 TX3644-20	
			3 TX3644-24	
			3-1/2 TX3644-28	
			3-3/4 TX3644-30	
			4 TX3644-32	
	2-1/2 X 2-3/4	2.510	2.755	2 TX4044-16
NOMINAL	2.508	2.753	2-1/2 TX4044-20	
			3 TX4044-24	
			3-1/2 TX4044-28	
	2-1/2 X 3	2.510	3.006	2 TX4048-16
NOMINAL	2.508	3.003	2-1/2 TX4048-20	
			3 TX4048-24	
			3-1/2 TX4048-28	
			3-3/4 TX4048-30	
			4 TX4048-32	
	2-3/4 X 3-1/4	2.7585	3.256	2-3/4 TX4452-22
NOMINAL	2.7565	3.253	3 TX4452-24	
			3-1/2 TX4452-28	
			3-3/4 TX4452-30	
			4 TX4452-32	
	3 X 3-1/2	3.015	3.506	2 TX4856-16
NOMINAL	3.008	3.503	3 TX4856-24	
			3-1/2 TX4856-28	
			3-3/4 TX4856-30	
			4 TX4856-32	
	3-1/2 X 4	3.515	4.007	3 TX5664-24
NOMINAL	3.508	4.004	3-1/2 TX5664-28	
			4 TX5664-32	



Special Cast Bronze Bearings + Machined Components



Custom Shafting + Bearing and P/M Assemblies

oilite®

BEARINGS

ADDITIONAL MANUFACTURING CAPABILITIES

- Extensive CNC machining facilities produce bearings in many common alloys
- In-house coating and impregnation facilities
- Special machined cast bronze bearings
- Close tolerance P/M bearings
- Graphiting
- Prototyping and sample services are available in P/M and most materials
- Production of shafts in many common steel alloys
- Secondary P/M machining and assembly
- SPC on all required runs
- Grooving

COMMON BRONZES

DESIGNATION NAME	CDA	MECHANICAL PROPERTIES				
		TENSILE STRENGTH (TYPICAL)	YIELD STRENGTH (TYPICAL)	ELONGATION	COMPRESSIVE YIELD STRENGTH (0.1 IN. SET/IN.)	HARDNESS BHN
HIGH-LEADED TIN BRONZE	C932000	35 KSI	18 KSI	15%, IN 2 IN.	46 KSI	65 (TYP)
HIGH PB-LOW ZN BRONZE	C936000	35 KSI	21 KSI	10%, IN 2 IN.	46 KSI	65 (TYP)
LEAD-FREE BRONZE	C89635	35 KSI	18 KSI	15%	42 KSI	65 (TYP)
ALUMINUM BRONZE	C95400	85 KSI	35 KSI	12%, IN 2 IN.	100 KSI	150 (MIN.)
ALUMINUM BRONZE	C95400 HT	105 KSI	54 KSI	6%, IN 2 IN.	100 KSI	190 (MIN.)
MANGANESE BRONZE	C86300	119 KSI	67 KSI	12%, IN 2 IN.	97 KSI	223 (MIN.)

WARRANTY. Seller warrants that if any product of its manufacture upon examination if found by a Seller's representative to be defective in either workmanship or material under normal use and service Seller, at its option, will repair or replace same free of charge including lowest transportation charges but not cost of installation or removal or will refund the purchase price thereof, provided that Seller receives written claim specifying the defect within ninety (90) day from date of distributor sale or one (1) year from date of factory shipment, whichever occurs first. In no event shall Seller be liable for any claims, whether arising from breach of contract or warranty or claims of negligence or negligent manufacture, in excess of the purchase price. ALL OTHER WARRANTIES EXPRESSED AND IMPLIED INCLUDING ANY WARRANTIES OF MERCHANTABILITY AND FITNESS FOR PARTICULAR USE ARE HEREBY DISCLAIMED. The foregoing expresses all of Seller's obligations and liabilities with respect to the quality of items furnished by it and it shall under no circumstances be liable for consequential, collateral or special losses or damages.

CONVERSION		
Fraction	Decimal	MM
1/64	0.0156	0.393
1/32	0.0312	0.793
3/64	0.0468	1.190
1/16	0.0625	1.587
5/64	0.0781	1.984
3/32	0.0937	2.381
7/64	0.1093	2.778
1/8	0.1250	3.175
9/64	0.1406	3.571
5/32	0.1562	3.968
11/64	0.1718	4.365
3/16	0.1875	4.762
13/64	0.2031	5.159
7/32	0.2187	5.556
15/64	0.2343	5.953
1/4	0.2500	6.350
17/64	0.2656	6.746
9/32	0.2812	7.143
19/64	0.2968	7.540
5/16	0.3125	7.937
21/64	0.3281	8.334
11/32	0.3437	8.731
23/64	0.3593	9.128
3/8	0.3750	9.525
25/64	0.3906	9.921
13/32	0.4062	10.318
27/64	0.4218	10.715
7/16	0.4375	11.112
29/64	0.4531	11.509
15/32	0.4687	11.906
31/64	0.4843	12.303
1/2	0.5000	12.700
33/64	0.5156	13.096
17/32	0.5312	13.493
35/64	0.5468	13.890
9/16	0.5625	14.287
37/64	0.5781	14.684
19/32	0.5937	15.081
39/64	0.6093	15.478
5/8	0.6250	15.875
41/64	0.6406	16.271
21/32	0.6562	16.668
43/64	0.6718	17.065
11/16	0.6875	17.462
45/64	0.7031	17.859
23/32	0.7187	18.256
47/64	0.7343	18.653
3/4	0.7500	19.050
49/64	0.7656	19.446
25/32	0.7812	19.843
51/64	0.7968	20.240
13/16	0.8125	20.637
53/64	0.8281	21.034
27/32	0.8437	21.431
55/64	0.8593	21.828
7/8	0.8750	22.225
57/64	0.8906	22.621
29/32	0.9062	23.018
59/64	0.9218	23.415
15/16	0.9375	23.812
61/64	0.9531	24.209
31/32	0.9687	24.606
63/64	0.9843	25.003
1	1.0000	25.400

W W W . C O A . N S K . C O M



NSK

NSK Canada Inc.
Sales Offices

Toronto

Tel. 905.890.0561

Toll Free 877.994.6675

Montreal

Tel. 514.633.1220

Toll Free 800.361.5861

Vancouver

Tel. 604.294.1151

Toll Free 877.994.6675

www.ca.nsk.com