

papeo[®]

AUTOMOTIVE AND INDUSTRIAL FASTENERS
ATTACHES AUTOMOBILE ET INDUSTRIEL

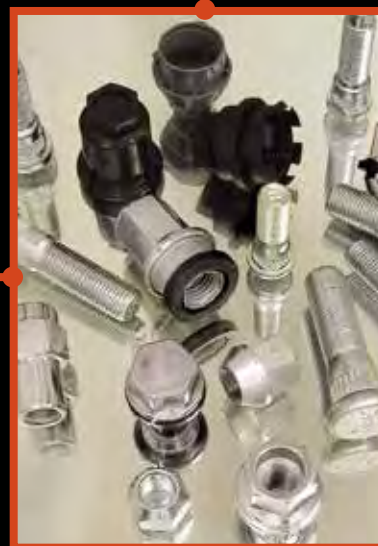

paulin[®]

H. Paulin & Co., a division of The Hillman Group Canada ULC



Since 1920, Papco has been manufacturing and merchandising quality automotive fasteners for original equipment and the aftermarket. Today there are over 15,000 items in the Papco line providing extensive coverage for all types of domestic and import vehicles and fastening applications. The company occupies over 700,000 square feet of space including 4 manufacturing facilities, 9 distribution centres and the head office located in Toronto. A leader in fastener and fitting merchandising, Papco provides innovative storage systems for efficient stocking and selling of its many products.



H. Paulin is ISO 9001 Certified and all catalogues, price lists and application data are available electronically and online.

Detailed application and specifications for:

Wheel Parts, Expansion Plugs, Drain Plugs, Body Shop Fasteners, Brass Fittings, Metric Fasteners, Non-Ferrous Fasteners, Agricultural Hardware and Brake/Fuel Line Repair products are published separately and posted on our website.



Depuis 1920, Papco fabrique et mets en marché des attaches de qualité pour automobiles comme équipement original et pour l'après-marché. Aujourd'hui, il existe plus de 15,000 items Papco qui offrent un très vaste choix de produits pour véhicules domestiques et importés, ainsi que pour toute sorte d'application d'attaches. La compagnie possède une surface de 700,000 p.c. d'espace qui inclus 4 sites de fabrication, 9 centres de distribution ainsi qu'un noyau central de distribution et bureau-chef situé à Toronto. Un chef de file dans la mise en marché de pièces et d'attaches, Papco offre un système innovateur d'entreposage pour distribuer et vendre ses nombreux produits.



H. Paulin a obtenu la certification ISO 9001. Tous les catalogues, listes de prix et données d'application sont disponibles en version électronique et en ligne.

Applications et spécifications détaillées pour :

Les pièces de roue, bouchons d'expansion, bouchons de vidange, attaches à carrosserie, attaches en laiton, attaches métriques, attaches non ferreuses, attaches pour l'agriculture et réparations pour canalisations de frein/d'essence sont publiés séparément et disponibles sur notre site web.

ASSORTMENTS ASSORTIMENTS



GARAGE ASSORTMENTS

UTILITY ASSORTMENTS

MASTER ASSORTMENTS

'SUPER-SERVICE' ASSORTMENTS

OTHER ASSORTMENTS

PLASTIC ASSORTMENT KITS

AGRICULTURAL HARDWARE... 246-255
ANCHOR NUTS & CLIPS..... 150
ANCHORS, Dynabolt® Sleeve..... 122
 Lag Bolt 67
 Tapcon®, Concrete..... 121
 Trubolt® Wedge..... 122
ANGLES, Slotted & Solid..... 87-88
ASSORTMENTS, Garage..... 3-4
 Master..... 7-9
 Metric..... 48-52
 Plastic..... 12
 Other..... 11
 Super Service..... 9-11
 Utility..... 5-6
BALL JOINTS, Throttle Rod..... 204
BINS, Bolt..... 14, 17-20
 Bulk Fastener..... 16
 Plastic Service..... 16
 Tilt-Out..... 13
BITS, 6-Lobe..... 120
 Drill..... 224-225
 Magnetic..... 128
 Power Driver..... 126-127
 Tapcon® Concrete..... 121
BLADES, Replacement Scraper..... 153
BODYSHOP FASTENERS..... 134-160
BOLT-N-NUT, Cabinet..... 15
 Gauges..... 208
BOLT BINS, Empty..... 14-15
 022KIT-01..... 19
 022KIT-02..... 19, 37
 022KIT-03..... 19, 37
 022KIT-08..... 19
 Assortments..... 17-20
BOLTS, Alternator..... 200
 Battery Hold Down..... 195-196
 Battery Terminal..... 196
 Body..... 42-44, 142
 Brake Block..... 199
 Bumper Bar..... 38, 143
 Carriage..... 67, 232
 Cylinder Head..... 201
 Elevator..... 66
 Flange..... 38
 Hex..... 58-61, 232
 Lag..... 67, 232
 Licence Plate..... 144
 Metric Hex..... 32, 33, 46
 Moulding..... 145
 Plow, Grade 5..... 67
 Rim..... *see current online*
Wheel Parts Catalogue
 Spring Centre..... 199
 Stainless Steel..... 232
 Starter..... 200
 Stove..... 104
 Torque-to-yield..... 201
 Wheel..... 183-185
BRACKETS, Tail Pipe (Muffler)..... 200
BRAKE LINES..... 238
BUSHINGS, Door Hinge..... 155-156
 Machinery..... 98, 255
CABINETS, Bolt-n-Nut..... 15
 Stax-Four..... 9
 Stax-Six..... 9
 Tilt-Out..... 16
CABLE TIES..... 190
CALIPER, Precision..... 208
CAP SCREWS, Bulk..... 59
 Button Head..... 33
 Captive Washer..... 33
 Grade 2 & 5..... 58
 Grade 5 Plated..... 59
 Grade 8 Plated..... 61
 Metric..... 32-33
 Socket Head..... 33
 Stainless Steel..... 232
CLAMPS, Battery Booster..... 194
 Battery Hold Down..... 195-196
 Hose..... 210-211
 Muffler..... 210
 Nylon Cable..... 211
CLIPS, Battery, Test..... 192
 Glass Shop..... 147
 Hitch Pin..... 82, 254-255

CLIPS, Moulding..... 146
 Throttle Rod..... 204
 Trim Fastener..... 148
 Tubular Speed Nut..... 137
CONTROLS, Push-Pull..... 212
 Vernier, Heavy Duty..... 213
 Wire Stops..... 213
DIES & TAPS..... 222
DRAIN COCKS..... 205
DRAIN PLUGS..... 168-172
DRILLS & TAPS..... 222-223
DRILL BITS..... 224-225
EXPANSION PLUGS..... 162-166
EXTRACTORS, Screw..... 223
FASTENERS, Body Shop..... 134-160
 Canvas..... 218
 Exhaust System..... 200
 Glass Shop..... 147
 Marine..... 233-235
 Metric..... 32-55
 Moulding..... 145-146
 'Palnut'..... 139-140
 Papcolloy..... 63
 'Pushnut'..... 140
 Snap..... 218
 Stainless Steel..... 232-235
 Trim..... 148
 Truck & Trailer..... 117
 Turn..... 218
 Weatherstrip..... 150
FAUCET, Drum..... 205
FITTINGS, Brake Line..... 242-243
 Drain Cock..... 205
 Grease..... 244
FLAT STEEL..... 88-89
FROST PLUGS..... 162-165
FUEL LINES..... *See current online*
Papcofelx Brochure
GASKETS, Drain Plug..... 168-172
GAUGES, Bolt-n-Nut..... 208
 Screw Thread Pitch..... 223
 Thickness Gauge..... 208
 Thread Detective..... 30, 209
GROMMETS, Anchor..... 150-151
 Brass..... 219
 Wire..... 190
HANDY-PAKS®..... 21-27
HOLD-DOWNS, Battery..... 195-196
HOLDERS, Fuse..... 190
HOLE PLUGS..... 154, 179
INSERTS, Perma-Thread®..... 228-230
 Sert-a-Nut..... 160
INSULATING TAPE..... 189
KEYS, Axle..... 178-179
 Socket Screw..... 73, 74
 Traditional..... 264
 Transponder..... 264
 Woodruff..... 177
KITS, Choke Conversion..... 213
 Drill Bit..... 225
 Expansion Plug..... 162
 Grommet, Brass..... 219
 Perma-Thread®..... 228
 Plastic Assortments..... 9
 Pro-Tip® (Power Tool)... 124, 129-132
 Socket Key..... 74
 Speedometer Cable..... 213
 Spee-Drill Screw..... 114
 Work-Saver® Washers..... 96
LEADS, Test..... 192
LETTERS..... 258-261
LINES, Brake..... 238-243
 Fuel..... *See current online*
Papcofelx Brochure
MAGNETS..... 220
MECHANICS' WIRE..... 179
MEGA-PAK®..... 28, 186
MERCHANDISERS, Automotive..... 29
 Bodysshop Fasteners..... 30
 Bolt-N-Nut Cabinet..... 15
 Brake/Fuel Line Repair Center..... 20
 Handy-Paks®..... 21-27
 Mega-pak®..... 28
METAL, Aluminum..... 88-89
 Angles..... 88

METAL, Cold Rolled..... 89
 Expanded Sheets..... 88-89
 Galvanized..... 89
 Flats..... 88
METRIC CLAMSHELL PACKS..... 34
NUMBERS..... 258-261
NUTS, Acorn (Cap)..... 64
 Air Cleaner Wing..... 203
 Anchor Grommet..... 150
 Battery Terminal..... 196
 Blind Well..... 160
 Brass..... 207
 Conelock..... 35, 62, 143, 185
 Coupling..... 86, 89
 Double Thick..... 64, 199
 Engine Stud..... 207
 Finished Hex Bare..... 35, 58, 63
 Finished Hex Plated..... 35, 59, 63
 Finished Grade 8..... 61
 Flange..... 35, 39, 66
 Heavy..... 63
 Jack, Mirror Mounting..... 160
 Keys, Locks..... 66
 Licence Plate..... 144, 150
 Machine Screw..... 55, 63, 105, 233
 Metric..... 35-36, 39, 47
 'Palnut' Locknuts..... 50, 139-140
 Panel..... 64
 Pozi-Lok® (Nylon Insert)..... 36, 65, 199
 'Pushnuts'..... 140
 Rim..... *see current online*
Wheel Parts Catalogue
 Sert-a-Nuts..... 160
 Speed..... 134-138
 Stainless Steel..... 47, 233
 Tri-Lok®..... 36
 Tensilock (Flange)..... 35, 39, 66
 'U' Nuts..... 41, 48, 141
 Wheel (Hub)..... 182, 185
 Wing..... 64
NUTSETTERS, Magnetic..... 128
'O' RINGS..... 178
PERMA-THREAD®, Inserts..... 228-230
PINS, Clevis..... 81-82
 Cotter..... 78-80, 234
 Door Hinge..... 155
 Hitch..... 254-255
 Metric..... 45, 49, 52-55
 Safety..... 78
 Slotted Spring..... 83
 Taper..... 84
PLIERS, Snap Ring..... 176
PLUGS, Button Hole..... 154, 179
 'Duo-Drain' Oil..... 170
 E-Z Seal Oil Drain..... 166
 E-Z Seal Expansion..... 166
 Expansion (Frost)..... 162-166
 Hole (Button)..... 154, 179
 Oil Drain..... 168-172
 Pipe..... 168, 202
 Repair, Oil Drain..... 169
POWER TOOLS & ACCESSORIES
 (Pro-Tip®)..... 124-132
PROTECTORS, Battery Term..... 194
PULLERS, Battery Term./Gear..... 192
RETAINERS, Bolt..... 42, 140
 Plastic Shield..... 149
 Screw-in..... 152
 Throttle Rod..... 204
RINGS, Snap..... 174-176
 Universal 'O'..... 178
RIVETS, Blind..... 157
 Panel, Aluminum..... 117
 Plastic..... 51, 151-152, 159
 Multi-Grip..... 158
 Window Regulator..... 146
RODS, Fully Threaded, Uni-Rod .. 86, 89
 Metric..... 45
 Round, Steel..... 87-88
 Stainless Steel, Threaded..... 234
SCISSORS, Utility..... 153
SCRAPERS, Utility..... 153
SCREWS, Brake Bleeder..... 242
 Brass Wood..... 108-109
 Cap..... 32-33, 46, 58-61, 70-71, 232

SCREWS, Drill-X, Self-Drilling... 115, 118-119
 Floorboard..... 118
 Lag..... 67, 232
 Machine..... 40, 104-107, 234
 Roofing/Siding..... 104
 Square Head Set..... 68
 Sheet Metal..... 110-113
 Spee-Drill..... 114
 Socket Cap..... 33, 70-71
 Socket Set..... 33, 72
 Tapcon®..... 121
 Tapping..... 40, 110-119, 234
 Trim..... 40, 115-117, 119, 235
 Thread Cutting..... 110
 6-Lobe Trim..... 119-120, 235
 Truck & Trailer..... 117-118
 Wood, Plated Steel..... 108-109
SCREWDRIVERS, Magnetic, 6 in 1 . 114
 Magnetic, 6-Lobe..... 114
 6-Lobe Bull Dog..... 120
SERT-A-NUTS..... 160
SHEARS, Utility..... 153
SHIELDS, Lag Bolt..... 68
SHIMS, Body..... 154
SHIM STOCK, Brass & Steel..... 217
SIGNS..... 258-262
SNAP RINGS..... 174-176
SPRINGS, Carburetor..... 214
 Pedal Return..... 214
 Utility..... 215
STEEL, Angle, Flats, Slotted..... 87-88
 Round Rods..... 87-88
 Sheets..... 88-89
 Tubular..... 87
STUDS, Engine..... 34, 45, 206
 Rear Wheel..... 185
TAPS & DIES..... 222
TECHNICAL..... 265-268
TERMINALS, Battery..... 193
 Wiring..... 188
TESTERS, Anti-Freeze..... 209
 Battery..... 194
 Circuit..... 191
THREADED RODS..... 45, 86, 234
THROTTLE BALL JOINTS..... 204
TIES, Cable..... 190
TOOLS, Circuit Testers..... 191
 Condrive® Installation..... 121
 Crimping..... 190
 Fuse Accessories..... 190
 Magnetic Retriever..... 220
 Magnetizer/Demagnetizer..... 220
 Riveting..... 158-159
 Screwdrivers..... 114, 120
 Snap Ring..... 176
 Terminal/Gear Puller..... 192
 Terminal/Post Cleaner..... 195
 Thread Cutting..... 223
 Trim Pad Release..... 149
 Window Handle Removing..... 153
 Windshield Moulding Release..... 153
TUBING, Brake Line..... 238-241
 Copper, Poly-v & Steel..... 241
 Round & Square..... 87
 Shrink..... 191
VACUUM CONNECTORS..... 221
WASHERS, Back-up Plates (Rivet)... 159
 Brass..... 99
 Copper..... 99
 Countersunk Finishing (Brass)..... 101
 Fender..... 98
 Fibre..... 97
 Hardened Steel, Tension..... 63
 Lock..... 94
 Machinery..... 98
 Metric..... 36
 Plain, Flat Steel..... 92
 S.A.E. Steel..... 93
 Spacer..... 100
 Tension..... 100
 Tooth Lock..... 96
 Stainless Steel..... 233
WHEEL PARTS..... 182-186
WIRE, Mechanics'..... 179
YOKES, Clevis..... 81

































GARAGE ASSORTMENTS ASSORTIMENTS POUR GARAGE

Papco® Garage Assortments are available in transparent plastic containers. You can see your stock of small fasteners—it is kept neat and handy. Your work bench is clear—yet the right fastener is available when you need it.

- Contains popular items used in every garage daily
- Contents are Bright Plated
- Quantity of each item is based on popularity
- Each assortment contains only listed items — no “odds and ends”
- Refills of individual items available from standard stock
- You get a wide range of sizes for any repair job for a minimum investment
- Three plastic compartments — speed up selection



020-047

GARAGE ASSORTMENTS Order by Stock Number			
020-010 Machine Screws Pg. 105  Round Square/Slot Drive Contains 130 Screws, 45 Nuts Screws: 6-32 x 3/8, 1/2, 3/4, 1", 1"-1/2; 8-32 x 3/8, 1/2, 3/4, 1", 1-1/2; 10-32 x 3/8, 1/2, 3/4, 1", 1"-1/2; Nuts: 6-32, 8-32, 10-32	020-024 Tapping Screws Pg. 111  Hexagon Head Contains 100 Screws 8 x 1/2; 10 x 3/8, 1/2, 5/8, 3/4; 14 x 1/2, 5/8, 3/4, 1", 1-1/4; 5/16 x 1"	020-040 Snap Rings External Pg. 174  Contains 60 Snap Rings 8 Sizes of 268-500 Series for 1/8" to 1/2" dia. shafts	
020-011 Machine Screws Pg. 106  Flat Head – Square Drive Contains 130 Screws, 45 Nuts Sizes same as listing for 020-010	020-026 Tapping Screws Pg. 111  Pan Head Slot 4 x 1/2; 6 x 1/2, 3/4, 1"; 8 x 1/2, 3/4, 1", 1-1/4; 10 x 5/8, 3/4, 1", 1-1/4; 12 x 3/4, 1"; 14 x 3/4, 1"	020-041 Snap Rings External Pg. 176  Contains 43 External Rings 6 Sizes of 268-600 Series Sizes: 5/32, 3/16L, 1/4, 5/16, 3/8, 9/16	
020-012 Machine Screws Pg. 107  Round Head - Phillips Contains 100 Screws, 50 Nuts 6-32 x 3/8, 1/2, 3/4; Nuts 8-32 x 3/8, 1/2, 3/4; Nuts 10-32 x 3/8, 1/2, 3/4; Nuts	020-027 Metric Trim Screws Pgs. 48  Pan Head, Oval Head – Phillips Contains 100 Screws, Metric Trim Screw Pan HD PLTD, Metric Trim screw Oval HD PLTD Round Washer HD POZI-DRIV®: 230-302, 230-304, 230-305	020-042 Snap Rings Internal Pg. 176  Contains 50 Internal Rings 10 Sizes of 268-200 Series Sizes: 1/2, 5/8, 3/4, 13/16, 7/8, 1", 1-1/8, 1-1/4, 1-1/2	
020-015 Speed Nuts Pg. 134  Flat Type Contains 160 Nuts 240-089, 091, 100, 101, 120, 158, 108, 127	020-028 Hole Plugs Pg. 179  Contains 47 Plugs 314-018, 020, 022, 024, 026, 030, 034	020-043 Square Head Pipe Plugs Pg. 202  Contains 20 Plugs 260-901, 902 & 903	
020-016 Speed Nuts Pg. 135  Formed Type Contains 65 Nuts 240-226, 228, 232, 242, 243, 247, 250, 267	020-030 Finishing Washers Pg. 101  Standard & Flush Types Contains 200 Washers 162-971, 973, 975, 977, 979, 988, 990, 994	020-044 Stove Bolts Pg. 104  Round Head Socket/Slot Drive; Contains 68 Bolts & Nuts: 10-24 x 1/2, 10-24 x 3/4, 10-24 x 1", 10-24 x 1-1/4, 10-24 x 1-1/2, 10-24 x 2, 1/4-20 x 1/2, 1/4-20 x 3/4, 1/4-20 x 1", 1/4-20 x 1-1/4, 1/4-20 x 1-1/2, 1/4-20 x 2"; Nuts: 10-24, 1/4-20	
020-017 Speed Nuts Pg. 136  Push-on Type Contains 160 Nuts 240-320, 325, 331, 335, 355, 365, 370	020-031 S.A.E. Washers Pg. 93  Small sizes Contains 400 Washers No. 2, No. 4, No. 6, No. 8, No. 10, 1/4	020-045 Stove Bolts Pg. 104  Flat Head, Square Drive; Contains 68 Bolts & Nuts: 10-24 x 1/2, 10-24 x 3/4, 10-24 x 1", 10-24 x 1-1/4, 10-24 x 1-1/2, 10-24 x 2", 1/4-20 x 1/2, 1/4-20 x 3/4, 1/4-20 x 1", 1/4-20 x 1-1/4, 1/4-20 x 1-1/2, 1/4-20 x 2"; Nuts: 10-24, 1/4-20	
020-018 Speed Nuts Pg. 137  Tubular Type Contains 70 Nuts 240-430, 431, 432, 469, 471, 472	020-032 Oversize Drain Plugs Pg. 171  Contains 7 Plugs with gaskets 263-711, 712, 713	020-046 Square Head Set Screws Pg. 68  Contains 35 Screws 1/4 x 1/2, 3/4, 5/16 x 1/2, 3/4; 3/8 x 1/2, 3/4, 1"; 7/16 x 1", 1/2 x 1", 2"	
020-020 Woodruff Keys Pg. 177  Contains 100 Keys 302-020, 030, 040, 050, 060, 080, 100, 110, 130, 150, 190, 200	020-033 Cotter Pins Pg. 78  Contains 340 Cotter Pins 1/16 x 3/4, 1"; 3/32 x 1", 1-1/2; 1/8 x 1", 1-1/2; 5/32 x 2"	020-047 Lock Washers Pg. 95  Contains 235 Washers 3/16, 1/4, 5/16, 3/8, 7/16, & 1/2	
020-021 Woodruff Keys Pg. 177  Contains 29 Large Keys 302-190, 200, 210, 214, 215, 220, 240 250, 257, 270, 280, 290, 291, 292	020-034 Tooth Lock Washers Pg. 96  Internal Type Plated Contains 225 Washers 3/16 x 1/4, 5/16, 3/8, 7/16 & 1/2	020-048 Expansion Plugs Pg. 164  Contains 50 Plugs 260-008, 010, 014, 018, 020, 024, 026, 028, 030, 034, 036, 039, 045, 054, 057, 069, 130, 144	
020-022 Throttle Rod Clips & Retainers Pg. 204  Contains 104 pieces 262-008, 009, 010, 011, 014, 015, 054, 056, 060, 062, 064, 073, 075, 076, 078, 262-203, 205, 206, 208	020-035 Tooth Lock Washers Pg. 96  External Type Plated Contains 225 Washers Sizes: #10 (3/16), 1/4, 5/16, 3/8, 7/16, 1/2	020-050 Taper Pins Pg. 84  Contains 46 Taper Pins 00 x 1", 1-1/2; 0 x 1", 1-1/2; 1 x 1", 1-1/2, 2" 2 x 1-1/4, 1-1/2, 2"; 3 x 1-1/4, 1-1/2, 2" 4 x 2", 2-1/2; 5 x 1-1/2, 2", 2-1/2	
020-023 Tapping Screws Pg. 116  Oval Head, Phillips Contains 100 Screws 6 x 1, 1-1/4 - Oval Regular 8 x 3/4, 1", 1-1/4, 1-3/8, 1-1/2, 1-3/4 10 x 1 - Oval Small	020-038 Inch & Metric Drain Plugs Pgs. 48  Contains 9 Inch & Metric Drain Plugs 4 of 1/2-20 STD., 3 of 12mm x 1.75, 2 of 14mm x 1.5	020-051 Taper Pins Pg. 84  Contains 36 Large sizes 4 x 1-1/2, 2", 2-1/2; 5 x 1-1/2, 2", 2-1/2; 6 x 2", 2-1/2, 3", 7 x 3"	

Note: Contents of assortments subject to change with market.

GARAGE ASSORTMENTS ASSORTIMENTS POUR GARAGE

GARAGE ASSORTMENTS Order by Stock Number								
020-052	'Palnuts' Self-Threading. Contains 100 Nuts 9 sizes for 1/8" to 5/16" dia. studs in regular.	Pg. 139	020-073	Hitch Pin Clips Contains 40 Clips 255-303, 310, 316, 321, 325, 326	Pg. 82	020-096	Hose Clamps Contains 28 Fuel Injection Hose Clamps 1/4, 5/16, 3/8	Pg. 211
020-053	Tensilock Flange Nuts Contains 50 Nuts 118-014, 016, 018, 020 & 022	Pg. 66	020-074	'Palnut' Lock Nuts Regular & Washer Types — Inch Contains 100 Nuts 242-016, 018, 020, 022 242-108, 110, 114, 116	Pg. 139	020-097	Hose Clamps Contains 55 Constant Tension Hose Clamps 3/8, 7/16, 1/2, 5/8, 3/4, 1"	Pg. 211
020-054	Nylon Drain Plug Gaskets Contains 60 Gaskets 263-816, 817, 818, 820, 824 & 828	Pg. 171	020-075	'Palnut' Lock Nuts Regular & Washer Types — Metric Contains 100 Nuts 243-004, 005, 105, 106	Pgs. 48 139	020-125	Metric Cap Screws I.S.O. Coarse Thread Contains 82 Screws M4 x 16; M5 x 16, 20, 25; M6 x 16, 25, 35.	Pg. 48
020-055	Keys Lock Nuts Contains 75 Nuts 119-006, 008, 010, 011, 014, 015, 016 & 018	Pg. 66	020-076	Bolt Retainers Inch sizes Contains 100 Retainers 242-314, 316, 318, 320, 322	Pg. 140	020-126	Metric Cap Screws I.S.O. Coarse Thread Contains 25 Screws M8 x 16, 20, 25, 35; M10 x 30, 40, 50.	Pg. 48
020-056	Brass Washers Contains 100 Washers 162-810, 812, 814, 816, 818, 820 & 822	Pg. 99	020-077	Bolt Retainers Metric Sizes Contains 100 Retainers 243-306, 308, 310, 312	Pgs. 48 140	020-127	Metric Hex Nuts I.S.O. Coarse Thread Contains 110 Nuts M4, M5, M6, M8, M10, M12	Pg. 48
020-057	Fender Washers Contains 71 Washers 1/4 x 1-1/4; 5/16 x 1", 1-1/4; 3/8 x 1-1/2	Pg. 98	020-078	'U' Nuts Multi-Thread — Inch Contains 65 Nuts 240-614, 616, 617, 618	Pg. 141	020-128	Metric Lock Nuts Nylon Collar — Pozi-Lok® Contains 33 Nuts. M4, M5, M6, M8, M10	Pg. 48
020-058	Steel Spacer Washers Contains 125 Washers 1/4, 5/16, 3/8, 7/16, 1/2, 9/16, 5/8, 3/4, 7/8, 1", 1-1/8, 1-1/4, 1-3/8 & 1-1/2	Pg. 100	020-079	'U' Nuts Multi-Thread — Metric Contains 50 Nuts 241-604, 605, 606, 607, 608, 609, 610	Pgs. 48 141	020-129	Metric Flat Washers Contains 235 Washers 4mm, 5mm, 6mm, 8mm, 10mm	Pg. 48
020-059	Fibre Washers Contains 130 Washers 1/32" Thick — 162-203, 206, 209, 211, 212, 214, 215, 210, 221. 1/16" Thick — 162-256, 259, 261, 262	Pg. 97	020-080	'U' Nuts Single-Thread — Inch Contains 65 Nuts 240-708, 709, 710, 714, 715	Pg. 141	020-130	Metric Lock Washers Contains 300 Washers 4mm, 5mm, 6mm, 8mm, 10mm	Pg. 48
020-061	Universal Clevis Pins Contains 15 Pins 255-044, 054, 064	Pg. 81	020-081	Blind Well Nuts Contains 20 Nuts 6-32, 8-32, 10-32, 1/4-20	Pg. 160	020-132	Metric Socket Set Screws Contains 29 Screws M4 x 5, 10; M5 x 10, 15; M6 x 8, 12, 20; M8 x 8, 12, 20.	Pg. 49
020-062	Clevis Pins Contains 41 Pins 255-225, 226, 228, 230, 231, 235, 236, 237, 238, 241, 242, 244, 246, 251	Pg. 82	020-083	Copper Washers Contains 100 Washers 162-860, 864, 866, 868, 870, 872	Pg. 99	020-133	Metric Machine Screws Contains 210 Screws & Nuts M4 x 6, 12; M5 x 10, 16; M6 x 10, 16, 20	Pg. 49
020-063	Utility Springs Compression & Extension Types Contains 100 Springs	Pg. 216	020-084	'Pushnut' Fasteners Contains 100 Fasteners 242-406, 408, 410, 414, 416, 418, 422; 243-404, 405	Pg. 140	020-134	Metric Cotter Pins Contains 275 Pins 1.5 x 16; 2 x 20; 3 x 25, 40; 4 x 50	Pg. 49
020-064	Pozi-Lok® Nuts UNC Coarse Thread Contains 40 Nuts 1/4, 5/16, 3/8, 7/16 & 1/2	Pg. 65	020-087	Socket Pipe Plugs Contains 20 Pipe Plugs 260-921, 922 & 923	Pg. 202	020-135	Metric Spring Pins Contains 64 Pins 2 x 16; 2.5 x 18; 3 x 40; 4 x 18, 36; 5 x 36, 50; 6 x 50	Pg. 49
020-065	Pozi-Lok® Nuts UNF Fine Thread Contains 40 Nuts 1/4, 5/16, 3/8, 7/16 & 1/2	Pg. 65	020-088	Cable Clamps Contains 40 Nylon Clamps 1/4, 3/8, 1/2, 5/8, 3/4, 1"	Pg. 217	020-200	Tapping Screws Pan Head — Socket Steel Contains 175 Screws 6 x 1/2; 6 x 5/8; 8 x 5/8; 8 x 3/4; 8 x 1; 10 x 1/2; 10 x 3/4; 10 x 1	Pg. 111
020-067	Wiring Terminals Contains 45 Terminals 569-422, 425, 426, 432, 461, 462, 464, 466, 467, 473, 500, 512, 516, 522, 531	Pg. 189	020-090	Sert-A-Nuts Contains 20 Inserts - plus Installation Tools 6-32, 8-32, 10-24, & 1/4-20	Pg. 160	020-201	Wood Screws Flat Head — Socket Steel Contains 160 Screws 6 x 1/2; 6 x 5/8; 8 x 3/4; 8 x 3/4; 8 x 1; 8 x 1-1/4; 10 x 1; 10 x 1-1/4	Pg. 108
020-070	6-Lobe Trim Screws Oval Head Contains 70 Screws 231-205, 206, 209, 210, 213, 219	Pg. 119	020-091	Snap Fasteners Contains 25 Fasteners 400-980, 981, 982, 983, 984, 985, 997	Pg. 219	020-207	Washers Washers (Flat & Locks) Assortment Work-Savers Kits. Assort sizes of Flat & Lock Washers Zinc Plated.	Pg. 96
020-071	6-Lobe Trim Screws Pan Head Contains 70 Screws 231-251, 252, 257, 264	Pg. 119	020-092	Lift-The-Dot® Fasteners Contains 20 Fasteners 400-900, 902, 903, 904, 913	Pg. 219	020-210	Brass Wood Screws Contains 155 pieces — 8 sizes Flat Socket Head — 6 x 1/2, 3/4, 1"; 8 x 3/4, 1", 1-1/4, 1-1/2 Round Socket Head — 6 x 3/4	Pg. 109
020-072	O-Rings Contains 78 Rings 15 sizes from 1/8" to 3/4" I.D.	Pg. 178	020-093	Turn Fasteners Contains 20 Fasteners 400-901, 905, 910, 911, 912	Pg. 219	020-212	Stainless Steel Fasteners Contains 110 pieces — 8 sizes 6 x 3/4; 8 x 3/4, 1"; 10 x 1, 1-1/2 Pan Socket 6 x 3/4, 1"; 8 x 1" Oval Socket Tapping Screws No. 6, 8 Finishing Washers	Pg. 235

Note: Contents of assortments subject to change with market.

**UTILITY ASSORTMENTS
ASSORTIMENTS UTILITAIRES**

**FOR GARAGE AND HARDWARE USE
POUR GARAGE ET UTILISATION DU MATÉRIEL**

These practical assortments enable every garage and repair shop to carry a useful stock of these popular fasteners.

- Every size in an individual compartment
- Sturdy, reinforced fibreboard display boxes with plastic trays
- Wide range of popular items at small cost
- Refills available from standard stock
- Suggested retail codes shown in lid
- Contents Bright Plated
- 5-1/2" W x 11-1/4" L x 1-1/2" D



020-353

**UTILITY ASSORTMENTS
ASSORTIMENTS UTILITAIRES**

UTILITY ASSORTMENTS Order by Stock Number								
	020-310 Wing Nuts Forged Steel Contains 151 Wing Nuts 8-31, 10-24, 1/4-20, 5/16-18, 3/8-16	Pg. 64		020-328 Socket Head Cap Screws Contains 36 Screws 1/4 x 3/4, 1", 1-1/2; 5/16 x 3/4, 1", 1-1/2; 3/8 x 1", 1-1/2; 7/16 x 1-1/2; 1/2 x 1-1/2	Pg. 71		020-348 'Conelock' Locknuts U.N.F. Fine Thread Contains 90 Nuts 1/4, 5/16, 3/8, 7/16, & 1/2	Pg. 62
	020-311 Wheel Nuts Contains 40 Wheel Nuts 558-014, 016, 027, 044, 047, 100; 559-125, 150	Pgs. 49 186		020-329 Clevis Pins Universal Type Contains 24 Pins with Cotter Pins 255-044, 054, 064, 074, 084, 106	Pg. 81		020-349 'Conelock' Locknuts U.N.C. Coarse Thread Contains 90 Nuts 1/4, 5/16, 3/8, 7/16, & 1/2	Pg. 62
	020-312 Tapping Screws Contains 495 Screws, Pan & Oval Slot Pan - 6 x 3/8, 1/2, 3/4, 1"; 8 x 3/8, 1/2, 3/4, 1"; 10 x 1/2, 3/4, 1"; 14 x 1" Oval - 6 x 3/4, 1"; 8 x 3/4, 1"; 10 x 3/4, 1"	Pg. 111		020-330 Carriage Bolts Contains 70 Bolts & 70 Nuts 1/4 x 1", 1-1/2; 5/16 x 1", 1-1/2, 2; 3/8 x 1", 1-1/2, 2, 3; 1/2 x 2, 3, 3-1/2; 5/8 x 3", 4"	Pg. 67		020-351 Tension Washers Contains 210 Washers 3/16, 1/4, 5/16, 3/8, 7/16, & 1/2	Pg. 100
	020-313 Cotter Pins Contains 1000 Cotter Pins 1/16 x 3/4, 1", 1-1/2; 3/32 x 3/4, 1", 1-1/2; 1/8 x 1", 1-1/2, 2"; 5/32 x 1-1/2	Pg. 79		020-331 Machine Screws Round Head - Square/Slot Drive Contains 320 Screws & 320 Nuts 4-40 x 1/2, 3/4; 6-32 x 3/8, 1/2, 3/4, 1"; 8-32 x 3/8, 1/2, 3/4, 1", 1-1/2, 2"; 10-32 x 1/2, 3/4, 1", 1-1/2	Pg. 106		020-352 Plain Steel Washers Contains 379 Washers (5.5 lbs.) 3/16, 1/4, 5/16, 3/8, 7/16, 1/2, 9/16, & 5/8 - Bolt Sizes	Pg. 92
	020-314 Hammer-Lock Cotter Pins Contains 800 Pins 1/16 x 3/4, 1", 1-1/2; 3/32 x 3/4, 1", 1-1/2; 1/8 x 1", 1-1/2, 2; 5/32 x 1-1/2	Pg. 80		020-332 Square Head Pipe Plugs Contains 42 Plugs 1/8, 1/4, 3/8, 1/2	Pg. 202		020-353 Tapping Screws Contains 500 Pan Head Socket Screws 4 x 1/2; 6 x 3/8, 1/2, 3/4, 1"; 8 x 3/8, 1/2, 3/4, 1", 1-1/4; 10 x 1/2, 5/8, 3/4, 1"; 12 x 3/4; 14 x 1"	Pgs. 5 111
	020-315 Speed Nuts Flat Type Contains 325 Nuts 240-090, 091, 097, 100, 101, 107, 120, 121, 127, 160	Pg. 137		020-333 Machine Screws Flat Head - Square Drive Contains 350 Bolts & 350 Nuts	Pg. 106		020-354 Wood Screws Contains 460 Flat & Round Head Socket Screws Flat - 4 x 1/2; 5 x 5/8; 6 x 3/4; 8 x 3/4, 1", 1-1/4, 1-1/2; 10 x 1/2 Round - 4 x 1/2; 5 x 5/8; 6 x 3/4; 8 x 1"	Pg. 108
	020-316 Speed Nuts Formed Type Contains 110 Nuts 240-210, 220, 227, 243, 246, 247, 248, 249, 263, 268	Pg. 137		020-336 Acorn (Cap) Nuts Zinc Alloy - Nickel Plated Contains 87 Nuts 6-32, 8-32, 10-24, 1/4-20, 5/16-18, 3/8-16, 1/2-13	Pg. 64		020-355 6-Lobe Trim Screws Contains 140 Oval & Pan Head Screws 231-205, 206, 209, 210, 213, 219, 251, 252, 257, 264	Pg. 120
	020-317 Speed Nuts Push-on & Tubular Contains 275 Nuts 240-320, 325, 340, 350, 355, 365, 370, 375, 410, 415, 430, 431, 440	Pg. 137		020-338 Hitch Pin Clips Contains 105 Clips 255-303, 306, 307, 308, 310, 311, 316, 320	Pg. 82		020-356 Brass Wood Screws Contains 380 Flat & Round Head Socket Screws Flat - 4 x 1/2; 5 x 5/8; 6 x 3/4; 8 x 3/4, 1", 1-1/4, 1-1/2; 10 x 1/2 Round - 4 x 1/2; 5 x 5/8; 6 x 3/4; 8 x 1"	Pg. 109
	020-318 'E-Z Seal' Expansion Plugs Contains 13 Plugs 263-548, 556, 564, 572, 580, 588, 596, 604, 612, 620, 628, 633, 644	Pg. 166		020-339 Lock Washers Contains 505 Washers 3/16, 1/4, 5/16, 3/8, 7/16, 1/2, 9/16, 5/8, 3/4	Pg. 95		020-358 Anchor Nuts Contains 150 Anchor Nuts Complete coverage	Pg. 151
	020-319 Spring Pins Contains 116 Pins 3/32 x 1/2, 1"; 1/8 x 1/2, 1"; 5/32 x 3/4, 1-1/2; 3/16 x 1", 1-1/2; 1/4 x 1", 1-1/2; 5/16 x 1-1/2; 3/8 x 2"	Pg. 83		020-340 Tooth Lock Washers Internal & External Types Contains 900 Washers No. 6, No. 8, No. 10, 1/4, 5/16, 3/8, 7/16, 1/2	Pg. 96		020-425 Metric Cap Screws Fine Thread Series Contains 100 Screws & Nuts	Pg. 49
	020-321 Socket Set Screws Contains 120 Screws: 8-32 x 3/16, 8-32 x 1/4, 10-24 x 3/16, 10-32 x 3/16, 1/4-20 x 1/4, 1/4-20 x 3/8, 1/4-28 x 1/4, 5/16-18 x 3/8, 5/16-18 x 1/2, 5/16-24 x 5/16, 3/8-16 x 1/2, 3/8-16 x 3/8	Pg. 75		020-341 S.A.E. Washers Contains 370 Washers 3/16, 1/4, 5/16, 3/8, 7/16, 1/2, 9/16 & 5/8	Pg. 93		020-426 Metric Cap Screws I.S.O. Coarse Thread Contains 160 Screws & Nuts	Pg. 49
	020-322 Brass Cotter Pins Contains 500 Pins 3/64 x 3/8; 1/16 x 3/4, 1", 1-1/2; 3/32 x 3/4, 1", 1-1/2; 1/8 x 1", 1-1/2, 2	Pg. 80		020-342 Utility Springs Extension & Compression Contains 83 Springs 311-604, 605, 606, 608, 609, 610, 611, 612, 615, 616, 618, 676, 677, 678, 684	Pg. 216		020-450 Specialty Retainers Contains 190 pieces of the most popular specialty rivets.	Pg. 151
	020-324 Stove Bolts Round Head - Square/Slot Drive Contains 200 Bolts & 200 Nuts: 10-24 x 1/2, 10-24 x 3/4, 10-24 x 1", 10-24 x 1-1/2, 1/4-20 x 3/4, 1/4-20 x 1", 1/4-20 x 1-1/2, 1/4-20 x 2", 10-24, 1/4-20	Pg. 104		020-343 Cotter Pins Large sizes - Contains 195 Pins 5/32 x 2"; 3/16 x 2", 2"-1/2; 1/4 x 2", 2"-1/2, 3"; 5/16 x 2"-1/2, 3"; 3/8 x 3"	Pg. 79			
	020-326 Cap Screws U.N.F. Fine Thread Contains 105 Screws 1/4 x 3/4, 1", 1-1/2; 5/16 x 3/4, 1", 1-1/2; 3/8 x 1", 1-1/2; 7/16 x 1-1/2; 1/2 x 1-1/2	Pg. 60		020-344 Square Head Set Screw Contains 66 Screws 1/4 x 1/2, 1"; 5/16 x 3/4, 1", 1"-1/2; 3/8 x 3/4, 1", 1"-1/2; 1/2 x 1", 2"	Pg. 68			
	020-327 Cap Screws U.N.C. Coarse Thread Contains 105 Screws Sizes same as listed for 020-326	Pg. 60		020-447 Hex Nuts U.N.C. & U.N.F. Contains 133 Nuts 1/4, 5/16, 3/8, 7/16, & 1/2	Pg. 60			

Note: Contents of assortments subject to change with market.



























MASTER ASSORTMENTS ASSORTIMENTS GÉNÉRAUX

- Assortments are packed in a sturdy, metal container with high-strength, moulded plastic compartments and hinged lid
- Individual compartments separate items for quick selection
- Illustrations and retail price codes shown on grease-resistant lid label
- Curved, 'coin-drawer' bottom makes removal easy
- Refills available in standard packages or Papco® Handy-Paks
- Carrying handle and safety snap lock for greater convenience
- Merchandiser size: 9-3/4" W x 13-3/4" L x 2" D







022-091 Stax-Six Cabinet – See page 9.

Assortments or Assortment Drawers NOT included.

MASTER ASSORTMENTS Order by Stock Number			
<p>020-500 Compression Fittings Contains 99 Fittings 660-3, 660-4, 660-5, 660-6, 661-3, 661-4, 661-5, 661-6, 662-3, 662-4, 662-5, 662-6, 668-2A, 668-3A, 668-4A, 668-5A, 669-2A, 669-3A, 669-4A, 669-5A</p> 	<p>020-604 Brake Bleeder Screws Pg. 242 Contains 63 Pieces 904-200, 201, 203, 204, 206, 209, 212, 213, 218, 219, D142-3, -4, -5, -6, DS141-3, -4, -5, -6, DS141-4-3, PC1176, PC1177, PC1178, MA300, MC300</p> 	<p>020-613 Tapping Screws Pg. 116 Contains 530 Pan, Oval Regular, Oval Small Head Phillips Screws Pan – 6 x 1/2; 8 x 1/2, 3/4; 10 x 1/2, 3/4 Oval Reg. – 6 x 3/4, 1"; 8 x 3/4, 1; 10 x 5/8, 1" Oval Small – 8 x 1/2, 3/4, 1"; 1-1/8, 1-1/4, 1-1/2; 10 x 3/4, 1", 1-1/2 230-205, 207, 302, 304, 305</p> 	
<p>020-501 Flare Fittings Contains 45 Fittings 441-3, 441-4, 441-5, 441-6, 442-3, 442-4, 442-5, 442-6, 446-4A, 446-5A, 448-3A, 448-4A, 448-4B, 448-5A, 448-5B, 448-6B, 449-4A, 449-5B, 449-6B</p> 	<p>020-605 Vacuum Connectors Pg. 221 Contains 138 Pieces 904-901, 902, 920, 922, 923, 924, 932, 939, 941, 960, 965, 975, 976, 990, 991, 992, 339</p> 	<p>020-614 Woodruff Keys Pg. 177 Contains 210 Keys 302-010, 020, 030, 040, 050, 060, 070, 080, 090, 100, 110, 121, 130, 150, 152, 160, 180, 200, 210, 240</p> 	
<p>020-502 Inverted Flare Contains 84 Fittings 141-3, 141-4, 141-5, 141-6, LS141-3, LS141-4, 142-3, 142-4, 142-5, 142-6, 148-3A, 148-4A, 148-5A, 148-5B, 148-6B, 149-3A, 149-4A, 149-5A, 149-5B, 149-6B</p> 	<p>020-606 Drain Cocks & Fittings Pg. 205 Contains 119 Fittings D39B, D40B, D60-3, -4, -5, -6, D61-3, -4, -5, -6, D62-3, -4, -5, -6; 260-902, 903, 904, 951, 952, 953, 957, 958</p> 	<p>020-615 Tapping Screws Pg. 112 Hexagon Head – Fender Washers Contains 280 Screws – 125 Washers 8 x 1/2; 10 x 3/8, 1/2, 5/8, 3/4; 14 x 1/2, 5/8, 3/4, 1", 1-1/4; 5/16 x 3/4, 1", 1-1/2; 3/8 x 1, 1-1/2; 162-394, 395, 396, 397, 398</p> 	
<p>020-503 Pipe Fittings Contains 71 Fittings 101-A, 101-B, 103-A, 103-B, 109-A, 109-B, 109-C, 110-BA, 110-CB, 110-DC, 112-A, 112-B, 112-C, 115-A, 115-B, 115-C, 124-A, 124-B, 124-C, TF-8</p> 	<p>020-607 Drain Plug Gaskets Pg. 171 Contains 210 Gaskets 263-800, 801, 802, 803, 804, 805, 807, 808, 809, 810, 815, 816, 817, 818, 855, 856, 860, 870, 873, 875</p> 	<p>020-617 Spee-Drill® Screws Pg. 114 Contains 1000 Screws 6 x 3/8; 7 x 1/2; 8 x 1/2; 10 x 1/2, 3/4 Also includes Magnetic Chuck</p> 	
<p>020-505 Fuel Line Fittings Contains 70 Fittings P1537, P1551, P1555, P1556, P1557, P1560, P1561, P1564, P1565, P1566, P1570, P1571, P1572, P1581, P1582, P1598, 101-C, 307-001, 307-002, 307-008</p> 	<p>020-608 Wing Nut and Hood Props Pg. 203 103-010, 014, 016, 018; 247-808, 809, 813, 823, 861; 263-314, 316, 324, 325, 326; 700-106, 108</p> 	<p>020-618 Cotter Pins Pg. 79 Contains 1230 Pins 1/16 x 1/2, 3/4, 1", 1-1/4, 1-1/2; 3/32 x 3/4, 1", 1-1/4; 1/8 x 1-1/2, 1-3/4, 2; 5/32 x 1-1/2, 2"; 3/16 x 1-1/2, 2"</p> 	
<p>020-506 Hose Barbs Contains 59 Fittings 9125-4A, 9125-4B, 9125-5A, 9125-5B, 9125-6B, 9125-6C, 9125-8C, 9125-8D, 9125-10C, 9125-10D, 9125-12D, 9125-12E, 9126-4A, 9126-4B, 9126-6B, 9126-6C, 9126-8D, 9129-4, 9129-6, 9129-8</p> 	<p>020-609 Carburetor Clips Pg. 204 Contains 293 Clips 262-008, 009, 010, 011, 014, 015, 054, 056, 062, 064, 073, 075, 076, 078, 080, 084, 088, 268-516</p> 	<p>020-619 S.A.E. Washers Pg. 93 Contains 1200 Washers 1/8, 3/16, 1/4, 5/16, 3/8, 7/16, 1/2, 9/16, 5/8, 3/4, 7/8, 1</p> 	
<p>020-507 Hydraulic Brake Fittings Contains 52 Fittings DS141-3, DS141-4, DS141-5, 142-3, 142-4, 142-5, PC1176, PC1177, PC1190, PC1191, PC1192, 7818, 7828, 7829, 7897, 7908, 7910, 7911, 7912</p> 	<p>020-610 Taper Pins Pg. 84 Contains 100 Pins 00 x 1, 1-1/2; 0 x 1, 1-1/2; 1 x 1, 1-1/2, 2" 2 x 1-1/4, 1-1/2; 2; 3 x 1-1/4, 1-1/2, 2" 4 x 1-1/2, 2, 2-1/2; 5 x 1-1/2, 2, 2-1/2, 3"</p> 	<p>020-620 Plain Steel Washers Pg. 92 Contains 1615 Washers 1/8, 3/16, 1/4, 5/16, 3/8, 7/16, 1/2, 9/16, 5/8, 3/4</p> 	
<p>020-600 Wood Screws Pg. 109 Flat & Round Head – Socket Contains 850 Screws 4 x 1/2, 3/4; 5 x 5/8; 6 x 3/4, 1, 1-1/4, 1-1/2; 8 x 3/4, 1, 1-1/4, 1-1/2; 10 x 3/4, 1, 1-1/2 – Flat Socket 4 x 1/2; 5 x 5/8; 6 x 3/4; 8 x 3/4, 1, 1-1/4; 10 x 1-1/2 – Round Socket</p> 	<p>020-611 Bumper Bar Bolts Pgs. 50 143 Contains 68 Bolts & 68 Nuts 245-153, 160, 161, 164, 165, 167, 172, 173, 174, 175, 182, 183, 184, 220, 221; 101-916, 918, 920, 922; 700-008</p> 	<p>020-621 Lock Washers Pg. 95 Contains 1257 pieces 1/8, 5/32, 3/16, 1/4, 5/16, 3/8, 7/8, 1/6, 1/2, 9/16, 5/8, 3/4, 7/8, 1"</p> 	
<p>020-601 Brass Wood Screws Pg. 109 Flat & Round Head – Socket Contains 735 Screws Sizes same as listed for 020-600</p> 	<p>020-612 Tapping Screws Pg. 112 Pan, Oval & Hex Head – Slot Contains 937 Screws Pan – 6 x 3/8, 1/2, 3/4, 1"; 8 x 3/8, 1/2, 3/4, 1"; 10 x 1/2, 3/4, 1"; 14 x 1 Oval – 6 x 3/4, 1"; 10 x 3/4 Hex – 8 x 1/2; 10 x 3/4; 14 x 1</p> 		







Note: Contents of assortments subject to change with market.

**MASTER ASSORTMENTS
ASSORTIMENTS GÉNÉRAUX**

MASTER ASSORTMENTS Order by Stock Number			
<p>020-622 Bolts, Nuts, Screws Pg. 60</p>  <p>Contains 1,367 pieces. 155 Cap Screws (U.N.C.), 143 Nuts (U.N.C.), 924 Lock Washers & S.A.E. Washers, 145 Stove Bolts (Round Head). Cap Screws – 1/4 x 3/4, 1/2 x 3/4, 3/8 x 1, 1-1/2 Nuts – 1/4, 5/16, 3/8; Lock Washers – 1/4, 5/16, 3/8 S.A.E. Washers – 1/4, 5/16, 3/8 Stove Bolts – 3/16 x 1; 1/4 x 3/4, 1"</p>	<p>020-639 Exhaust System Fasteners Pg. 200</p>  <p>Contains 170 pieces Cap Screws – 5/16-18 x 1-1/4, 1-1/2, 2"; 3/8-16 x 1-1/2, 2", 4-1/2, 5-1/2; 7/16-14 x 2; 9/16-12 x 2 Brass Nuts – 264-955, 958, 959, 957 Steel Nuts – 264-903, 905, 908 Carriage Bolts – 5/16 x 1-1/2; 3/8 x 1-1/2 Hex Nuts – 5/16-18, 3/8-16, 7/16-14, 9/16-12</p>	<p>020-666 Metric Expansion Plugs Pgs. 50 165</p>  <p>Contains 120 Standard & Cup Types 261-024, 046, 090, 100, 107, 126, 132, 145, 155, 161, 165, 177, 182, 184, 185, 188</p>	
<p>020-623 Machine Screws Pg. 107</p>  <p>Round & Oval Head – Phillips Contains 393 Screws, 393 Nuts Round – 6-32 x 3/8, 1/2, 8-32 x 3/8, 1/2, 3/4, 1"; 10-32 x 1/2, 3/4; 10-24 x 1/2; 1/4-20 x 1/2, 3/4, 1" Oval – 8-32 x 1/2; 10-32 x 1/2; 10-24 x 3/4 Nuts – 6-32, 8-32, 10-32, 10-24, 1/4-20</p>	<p>020-640 Expansion Plugs Pg. 164</p>  <p>Contains 140 Standard & Cup Types 260-008, 010, 014, 018, 020, 024, 028, 030, 036, 039, 045, 054, 057, 069, 114, 159, 174, 186, 194</p>	<p>020-667 Blind Rivets Pg. 158</p>  <p>Contains 1200 Pieces 239-492, 493, 494, 611, 617, 653, 714, 717, 750, 753, 811, 814, 817</p>	
<p>020-624 Machine Screws Pg. 106</p>  <p>Round Square/Slot & Flat Square Drive Contains 560 Screws, 560 Nuts Round – 6-32 x 3/8, 1/2, 1, 1-1/2; 8-32 x 3/4, 1", 1-1/2; 10-32 x 1/2, 1, 1-1/2; 1/4-20 x 3/4, 1", 1-1/2 Flat – 6-32 x 3/8, 1/2, 1; 8-32 x 1/2, 3/4, 1", 1-1/2; 10-32 x 1/2, 1, 1-1/2; 1/4-20 x 1 Nuts – 6-32, 8-32, 10-32, 10-24, 1/4-20</p>	<p>020-641 Clevis Pins Pg. 82</p>  <p>Contains 78 Pins 255-044, 054, 064, 074, 086, 203, 221, 224, 225, 226, 228, 235, 236, 237, 241, 244, 245, 246, 251, 248</p>	<p>020-668 "Drill-X" Self-Tapping Screws Pg. 119</p>  <p>Contains 395 Screws Complete Coverage</p>	
<p>020-625 Tooth Lock Washers Pg. 96</p>  <p>Internal & External Types Plated Contains 1370 Washers 161-106, 108, 110, 114, 118, 120, 122, 124, 128, 132, 206, 208, 210, 214, 218, 220, 222, 224, 228, 232</p>	<p>020-642 Spring Pins Pg. 83</p>  <p>Contains 275 Pins 3/32 x 1/2, 3/4, 1"; 1/8 x 1/2, 3/4, 1"; 5/32 x 3/4, 1"; 1-1/2; 3/16 x 3/4, 1", 1-1/2; 1/4 x 1-1/2, 2; 5/16 x 1, 1-1/2, 2; 3/8 x 1-1/2, 2"</p>	<p>020-669 6-Lobe Trim Screws Pgs. 50 120</p>  <p>Contains 240 Screws Complete Coverage</p>	
<p>020-626 Universal O-Rings Pg. 178</p>  <p>Contains 300 Rings Complete coverage</p>	<p>020-643 Speed Nuts Pg. 138</p>  <p>Contains 467 Push-on & Tubular Types 240-310, 315, 320, 325, 330, 331, 335, 340, 350, 355, 360, 365, 370, 375, 380, 405, 410, 430, 431, 450, 470, 471</p>	<p>020-673 Marine Fasteners Pg. 235</p>  <p>Contains 500 18.8 Stainless Steel Fasteners Tapping Screws: 4 x 1/2; 6 x 3/4; 8 x 3/4, 1"; 10 x 1" Pan & Oval Slot Wood Screws: 6 x 3/4; 8 x 3/4, 1"; 10 x 1", 1-1/2 • Machine Screws: 6-32 x 1/2; 8-32 x 1"; 10-24 x 1-1/2; 1/4-20 x 2" Nuts – 6-32, 8-32, 10-24, 1/4-20 Finishing Washers – No. 6, 8, 10, 1/4</p>	
<p>020-627 Snap Rings Pg. 174</p>  <p>Contains 401 Rings – 36 sizes 268-222, 224, 226, 227, 230, 231, 232, 234, 237, 238, 242, 246, 329, 330, 332, 414, 418, 422, 424, 426, 428, 430, 505, 506, 511, 514, 516, 518, 520, 522, 606, 610, 614, 616, 618, 620</p>	<p>020-644 Speed Nuts Pg. 138</p>  <p>Contains 421 Formed & Flat Types 240-090, 091, 097, 100, 101, 107, 120, 121, 125, 127, 160, 210, 220, 227, 248, 249, 260, 263, 267, 268</p>	<p>020-674 'Palnut' Fasteners Pgs. 50 140</p>  <p>Contains 325 Pieces 242-016, 018, 108, 110, 114, 116, 216, 314, 316, 318, 406, 408, 410, 413; 243-004, 106, 204, 306, 308, 310, 404, 405</p>	
<p>020-628 Battery Hold-Down Bolts Pg. 195</p>  <p>Contains 130 Pieces 570-610, 611, 612, 613, 614, 615, 617</p>	<p>020-646 Cap Screws Pg. 60</p>  <p>Contains 208 U.N.F. Fine Thread Grade 5 Plated 1/4 x 1/2, 3/4, 1", 1-1/2, 2"; 5/16 x 3/4, 1", 1-1/4; 5/16 x 1-1/2, 2"; 3/8 x 1", 1-1/2, 2"; 7/16, 1", 1-1/2, 2"; 1/2 x 1-1/2, 2"; 5/8 x 1-1/2, 2"</p>	<p>020-678 Anchor Grommets and Nuts Pg. 151</p>  <p>Contains 295 Grommets & Nuts 247-610, 611, 620, 625, 630, 650, 660, 665, 670, 710, 715, 720, 730, 735, 811, 812, 815, 820, 826, 830, 840</p>	
<p>020-629 Socket-Set Screws Pg. 76</p>  <p>Contains 166 Screws 138-132, 133, 184, 185, 301, 303, 305, 437, 438, 440, 483, 575; 139-184, 301, 437</p>	<p>020-647 Cap Screws Pg. 60</p>  <p>Contains 208 U.N.C. Coarse Thread Grade 5 Plated Same sizes as listed for 020-646</p>	<p>020-679 Trim Fasteners Pg. 151</p>  <p>Contains 150 Fasteners – General Motors 247-012, 053, 056, 061, 080, 082, 085, 090, 101, 150, 210, 211, 212, 215, 216, 222, 235, 248, 249, 250</p>	
<p>020-630 Drain Plugs Pg. 171</p>  <p>Contains 40 Plugs & 73 Gaskets: 263-710, 718, 778, 815, 817, 844, 856, 870, 875, 876, 885, 908, 911, 912, 913, 914, 917, 919, 929, 923, 925, 933, 934, 954, 937, 942, 944, 974, 984</p>	<p>020-648 Hex Nuts Pg. 60</p>  <p>Contains 376 Nuts U.N.C., U.N.F. & Thick Slotted 1/4, 5/16, 3/8, 7/16, 1/2, 5/8, 3/4</p>	<p>020-680 Trim Fasteners Pg. 151</p>  <p>Contains 150 Fasteners – Chrysler & Ford 247-025, 038, 052, 055, 062, 065, 110, 136, 165, 211, 215, 230, 231, 232, 236, 237, 238, 245, 252, 253</p>	
<p>020-631 Perma-Thread® Inserts Pg. 226</p>  <p>Includes contents of one Repair Kit of each size 10-24, 1/4-20, 5/16-18, 3/8-16, 7/16-14, 1/2-13 & 14 mm with 3/8, 7/16, 1/2 & 3/4 reach. Includes Inserts, Taps, Installation Tools & Instructions</p>	<p>020-649 Pozi-Lok® Nuts Pg. 65</p>  <p>Contains 175 of both U.N.C. Coarse & U.N.F. Fine Threads 1/4, 5/16, 3/8, 7/16, 1/2, 9/16, 5/8, 3/4</p>	<p>020-685 Grease Fittings Pgs. 51 244</p>  <p>Contains 160 Inch & Metric Fittings 904-610, 612, 613, 363, 641, 652, 688, 691, 701, 702, 703, 745, 746, 747, 790, 791, 792</p>	
<p>020-632 Manifold Studs and Nuts Pgs. 200 207</p>  <p>Contains 80 Pieces Studs – 264-048, 049, 060, 094 Nuts – 264-954, 955, 956, 957, 958, 959</p>	<p>020-650 Wiring Terminals Pg. 189</p>  <p>Contains 325 Wiring Terminals Complete coverage</p>	<p>020-692 'U' Nuts Pgs. 51 141</p>  <p>Contains 100 Nuts 240-614, 615, 616, 617, 618, 619, 706, 708, 709, 710, 714, 715; 241-604, 605, 606, 607, 608, 609, 610, 612</p>	
<p>020-633 Expansion Plugs Pg. 164</p>  <p>Oval Head Contains 110 Cup & Shallow Cup Types 260-114, 120, 130, 142, 144, 159, 168, 174, 186, 194, 198, 219, 311, 327, 333, 339, 365, 368</p>	<p>020-658 Wheel Parts Pgs. 50 186</p>  <p>Contains 125 Bolts & Nuts. Universal 558-014, 016, 027; 559-150; 560-103, 114, 138, 148, 155, 167, 172, 173, 386; 561-108, 109, 110, 129, 212, 248, 251</p>	<p>020-693 Plasti-Rivets Pg. 51</p>  <p>Contain 150 Rivets 247-300, 301, 302, 303, 304, 305, 306, 307, 401, 402, 403, 405, 406, 407, 411, 462, 464, 466, 467, 468</p>	
<p>020-635 Drain Plugs Pg. 171</p>  <p>See Drain Plugs Assortment 020-630.</p>	<p>020-660 Tapping Screws Pg. 112</p>  <p>Pan Head-Socket – Contains 1000 Screws 4 x 3/8, 1/2; 6 x 3/8, 1/2, 3/4, 1"; 8 x 3/8, 1/2, 5/8, 3/4, 1"; 1-1/4, 1-1/2; 10 x 1/2, 3/4, 1", 1-1/4, 1-1/2, 2"; 12 x 3/4, 1", 1-1/4; 14 x 1", 1-1/2, 2"</p>	<p>020-725 Metric Cap Screws and Nuts Pg. 51</p>  <p>Contains 570 Cap Screws & Nuts M4 x 16; M5 x 12, 16, 20, 25; M6 x 12, 16, 20, 25, 30, 35, 45 – Cap Screws M4, 5, 6 – Nuts & Lock Nuts</p>	
<p>020-636 Square Head Set Screws Pg. 68</p>  <p>Contains 82 Screws: 1/4 x 1/2, 3/4, 1; 5/16 x 1/2, 3/4, 1, 1-1/2; 3/8 x 1/2, 3/4, 1, 1-1/4, 1-1/2; 7/16 x 3/4, 1, 1-1/2; 1/2 x 3/4, 1, 1-1/4, 1-1/2, 2</p>	<p>020-661 Chrome Trim Screws Pg. 50</p>  <p>Contains 350 Screws 229-806, 811, 815, 819, 833, 837, 985, 986; 230-203, 205, 206, 207, 301, 302, 304, 305</p>	<p>020-726 Metric Cap Screws and Nuts Pg. 51</p>  <p>Contains 186 Cap Screws & Nuts M8 x 12, 16, 20, 25, 30, 40, 60, 70; M10 x 30, 40, 50, 60, 70 – Cap Screws M8, 10 – Nuts & Lock Nuts</p>	
<p>020-637 Utility Springs Pg. 216</p>  <p>Contains 135 Compression, Extension & Throttle Springs: 311-601, 602, 603, 604, 605, 606, 607, 608, 610, 611, 612, 615, 616, 617, 618, 622, 623, 624, 628, 631, 632, 635, 636, 650, 653, 655, 656, 658, 661, 676, 677, 678</p>	<p>020-662 Black Trim Screws Pg. 115</p>  <p>Contains 350 Screws 229-401, 402, 403, 405, 407, 414, 416, 849, 851, 855, 883, 887, 911, 915, 919, 933, 937, 945, 962, 968, 972, 980, 982, 987, 988; 230-303, 306</p>	<p>020-727 Metric Washers Pg. 51</p>  <p>Contains 1000 Flat, Lock & Spring Washers 4 mm, 5 mm, 6 mm, 8 mm, & 10 mm of all three types.</p>	

Note: Contents of assortments subject to change with market.

**MASTER ASSORTMENTS
ASSORTIMENTS GÉNÉRAUX**

MASTER ASSORTMENTS Order by Stock Number			
<p>020-730 Metric Cap Screws and Nuts Pg. 52</p> <p>Fine & Extra Fine Thread Contains 130 Cap Screws & Nuts 609-320, 324, 368, 370, 372, 374, 416, 418; 610-366, 368, 372, 374, 414, 416, 418; 670-208, 210, 212, 750, 765</p> 	<p>020-728 Metric Socket Set Screws and Machine Screws Pgs. 50-51</p> <p>Contains 100 Set Screws M4 x 5, 10; M5 x 10, 15; M6 x 8, 12, 20; M8 x 8, 12, 20; plus M2, 2.5, 3, 4 Keys Contains 140 Machine Screws & Nuts M4 x 6, 12; M5 x 10, 16; M6 x 10, 16, 20 – Screws M4, 5, 6 – Nuts</p> 	<p>020-729 Metric Cotter and Spring Pins Pg. 52</p> <p>Contains 675 Cotter Pins 1.5 x 16; 2 x 20; 3 x 25, 40; 4 x 50 Contains 160 Spring Pins 2 x 16; 2.5 x 18; 3 x 24, 40; 4 x 18, 36, 50; 5 x 36, 50; 6 x 22, 50</p> 	
<p>021-600 S.S. Marine Kit #1 Bolts, Nuts & Washers Pg. 12</p> <p>Contains 514 pieces. 5200-309, 313, 444, 448, 489, 493 5002-316, 451 • 5168-193, 197, 280 5171-193, 197, 280 • 5226-014, 016, 018 5232-014, 016, 018 • 5258-010, 014, 016, 018 5255-010, 014, 016, 018 • 5037-010, 014, 016 5037-018 • 5038-010, 014, 016, 018 5057-394, 395, 5057-396, 398</p> 	<p>021-601 S.S. Marine Kit #2 Screws, Washers & Bits Pgs. 12-235</p> <p>Contains 648 pieces. 140-821, 822, 823, 841, 842, 843 222-360, 365, 366 • 5056-973, 975, 979 5057-394, 395 • 5162-087, 137, 141, 145, 5162-191, 193, 197, 250, 280 • 5163-087, 137, 5163-141, 145, 191, 193, 197, 250, 254, 280 5176-034, 035, 039, 044 5177-074, 080, 082, 087, 093, 095</p> 	<p>021-605 Wood Screw Organizer Pgs. 12-235</p> <p>Assortment of 530 wood screws 42 Types of Round & Flat Head Wood screws: #10 x 3/4 • 1 • 1-1/4 • 1-1/2 • 2 • 2-1/2 • 3 #8 x 1/2 • 3/4 • 1 • 1-1/2 • 2 • 2-1/2 • 3 #6 x 1/2 • 5/8 • 3/4 • 1 • 1-1/4 • 1-1/2 • 2</p> 	
<p>021-610 Bolt-and-Nut Organizer Pg. 12</p> <p>Assortment of 529 Machine Screws, Bolts, Nuts & Washers: M. Sc.: 6-32 x1/2, x3/4, x1, x1-1/2, x2; 8-32 x1/2, x3/4, x1, x1-1/2, x2; 10-24 x1/2, x3/4, x1, x1-1/2, x2 Bolts: 5/16 x1, x1-1/2, x2, x2-1/2, x3; 1/4 x1, x1-1/2, x2, x2-1/2, x3; 3/8 x1, x1-1/2, x2, x2-1/2, x3 Nuts: 6/32; 8/32; 10-24; 5/16-18; 3/8-16; 1/4-20 Washers: 1/8BS; 3/16BS; 5/16; 1/4; 3/8; #8 L. Washers: 5/16; 1/4; 3/8; #4; #8; #10(3/16)</p> 			

Note: Contents of assortments subject to change with market.

**MASTER ASSORTMENTS
ASSORTIMENTS GÉNÉRAUX**

No. 022-091

STAX-SIX CABINET

Papco[®] Stax-Six Cabinet holds six Master Assortments in its own rigid drawer slide. Made of heavy gauge steel with a baked-on enamel finish.

Size: 15-1/2" H x 11-3/4" D.

- Heavy gauge steel construction
- Baked black enamel finish
- Rigid drawer slide
- No spill feature
- Holds six Master Assortments
- Build as you buy
- Designed for efficient stacking one on top of another or side by side. (Not Illustrated)

022-091



Assortments or Assortment Drawers NOT included.

**'SUPER-SERVICE' ASSORTMENTS
ASSORTIMENTS DE 'SUPER-SERVICE'**

No. 022-093

STAX-FOUR CABINET

Perfect for Dealers, Jobbers and large users. These popular assortments have a wide range of carefully selected items in balanced quantities.



























- Each Papco[®] Stax-Four Cabinet holds four Super-Service Assortments
- Welded steel construction
- Rigid drawer slide
- Baked black enamel finish
- No-spill safety feature
- Size: 20" W x 14-1/2" H x 15-3/4" D

022-093



Assortments or Assortment Drawers NOT included.

'SUPER-SERVICE' ASSORTMENTS
ASSORTIMENTS DE 'SUPER-SERVICE'

SUPER SERVICE ASSORTMENTS Order by Stock Number			
<p>020-800 Expansion Plugs Pg. 164</p>  <p>Contains 200 Standard & Cup Types 260-008, 010, 014, 018, 020, 024, 028, 030, 036, 039, 045, 054, 057, 114, 120, 130, 142, 144, 159, 165, 168, 174, 177, 180, 186, 194, 198, 204, 240</p>	<p>020-809 Phillips Trim Screws Pg. 116</p>  <p>Contains 1225 Phillips Screws 229-010, 012, 022, 024, 026, 044, 110, 120, 122, 140, 142, 164, 220, 222, 224, 226, 228, 240, 242, 244, 248, 250, 252; 230-203, 205, 207, 301, 302, 304, 305</p>	<p>020-819 Spring Pins Pg. 83</p>  <p>Contains 770 Spring Pins 1/16 x 1/2, 3/4, 1"; 3/32 x 1/2, 3/4, 1"; 1/8 x 3/8, 1/2, 3/4, 1"; 1-1/4, 1-1/2, 2; 5/32 x 1/2, 3/4, 1"; 1-1/2; 3/16 x 1/2, 3/4, 1"; 1-1/2, 2; 1/4 x 3/4, 1"; 1-1/2, 2; 5/16 x 1, 1-1/2, 2; 3/8 x 1", 1-1/2, 2.</p>	
<p>020-801 Expansion Plugs Pg. 164</p>  <p>Contains 170 Cup & Shallow Cup Types 260-114, 118, 120, 130, 142, 144, 159, 165, 168, 174, 177, 180, 186, 194, 198, 204, 207, 219, 240, 311, 318, 327, 333, 339, 351, 365, 368, 370, 372, 378</p>	<p>020-810 Speed Nuts Pg. 138</p>  <p>Contains 685 Speed Nuts in Flat, Push-on & Formed Types 240-090, 091, 097, 100, 101, 107, 120, 121, 125, 127, 160, 210, 220, 227, 228, 243, 245, 246, 247, 248, 249, 260, 263, 267, 268, 335, 350, 355, 360, 365, 370</p>	<p>020-820 Woodruff Keys Pg. 177</p>  <p>Contains 374 Woodruff Keys 302-010, 020, 030, 040, 050, 060, 061, 070, 080, 090, 091, 100, 110, 120, 121, 130, 140, 150, 152, 160, 170, 180, 183, 190, 200, 210, 214, 220, 240, 250, 270, 280</p>	
<p>020-802 Wheel Parts Pg. 186</p>  <p>Contains 180 Bolts & Nuts, Universal 558-014, 016, 027; 559-125, 150; 560-102, 103, 105, 114, 138, 148, 155, 167, 172, 173, 386, 604; 561-100, 102, 106, 108, 109, 110, 111, 120, 129, 154, 166, 167, 212, 248, 251</p>	<p>020-811 'Palnut' Fasteners Pg. 140</p>  <p>Contains 500 Regular & Self-Threading 'Palnuts' plus Bolt Retainers & 'Pushnuts' 242-016, 018, 020, 022, 110, 114, 116, 206, 207, 208, 209, 210, 211, 214, 215, 216, 314, 316, 318, 406, 408, 410, 414, 416, 418; 243-004, 106, 204, 306, 308, 310, 404</p>	<p>020-821 Universal O-Rings Pg. 178</p>  <p>Contains 390 O-Rings Complete coverage</p>	
<p>020-803 Socket Set Screws Pg. 76</p>  <p>Contains 240 Set Screws & Keys Complete coverage of Socket Set Screws plus 140-101, 102, 103, 104, 107, 108, 110, & 111 Hex Keys</p>	<p>020-812 Wiring Terminals Pg. 189</p>  <p>Contains 500 Terminals Complete coverage</p>	<p>020-822 Moulding Bolts Pg. 145</p>  <p>Universal Contains 195 Moulding Bolts Complete coverage 246-112 to 324</p>	
<p>020-804 Flat and Lock Washers Pg. 95</p>  <p>Contains 3020 Plain, S.A.E., Lock, Tooth Lock & Fender Washers Flat - 3/16, 1/4, 5/16, 3/8, 7/16, 1/2 S.A.E. - No. 8, 10, 1/4, 5/16, 3/8, 7/16, 1/2 Lock - No. 8, 10, 1/4, 5/16, 3/8, 7/16, 1/2 Internal Tooth - 3/16, 1/4, 5/16, 3/8 External Tooth - 3/16, 1/4, 5/16, 3/8 Fender - 162-395, 396, 398, 399</p>	<p>020-813 Trim Fasteners Pg. 151</p>  <p>Contains 300 Trim & Weather-strip Fasteners plus Shield Retainers Complete coverage (except 247-026)</p>	<p>020-834 Body Bolts & Nuts Pg. 11</p>  <p>Contains 327 Body Bolts & Nuts 1/4-20, 5/16-18, 5/16-18L, 3/8-16L, #8, #8L, #10, M6 x 1.0, M6 x 1.0 L, M8 x 1.25L, M8 x 1.25, M6 x 22mm, M4.2 x 20, M6 x 1.0 x 25, M8 x 1.25 x 30, M8 x 25mm, 1/4-20 x 1 1/4, 5/16-18 x 7/8, 5/16-18 x 1, 3/8-16 x 1, 3/8-16 x 1-1/2</p>	
<p>020-805 Cotter Pins Pg. 79</p>  <p>Contains 3345 Cotter Pins & Throttle Rod Retainers. 1/16 x 1/2, 3/4, 1", 1-1/4, 1-1/2; 3/32 x 3/4, 1", 1-1/4, 2"; 1/8 x 3/4, 1", 1-1/4, 1-1/2, 1-3/4, 2"; 5/32 x 1", 1-1/4, 1-1/2, 2"; 3/16 x 1", 1-1/4, 1-1/2, 2" Retainers - 262-203, 205, 206, 208, 210, 214, 216, 218</p>	<p>020-814 Anchor Grommets and Nuts Pg. 151</p>  <p>Contains 465 Grommets & Nuts 247-610, 611, 615, 620, 621, 650, 655, 660, 665, 670, 710, 715, 720, 725, 730, 735, 810, 811, 812, 815, 820, 826, 830, 840, 821, 825</p>	<p>020-836 Metric Flange Bolts & Nuts Pg. 11</p>  <p>M6-1.0 x 16, M6-1.0 x 20, M6-1.0 x 25, M6-1.0 x 30, M6-1.0 x 40, M8-1.25 x 16, M8-1.25 x 20, M8-1.25 x 30, M8-1.25 x 35, M8-1.25 x 40, M8-1.25 x 1.25 x 50mm, M8-1.25 x 60mm, M10-1.25 x 20, M10-1.25 x 30, M10-1.25 x 40, M10-1.25 x 50mm, M6 x 1.0 JIS, M8 x 1.25 JIS, M10 x 1.25 JIS</p>	
<p>020-806 Machine Screws and Nuts Pg. 106</p>  <p>Contains 2750 Round Square/Slot & Flat Square Drive Screws & Nuts Round - 6-32 x 3/8, 1/2, 3/4, 1", 1-1/2; 8-32 x 1/2, 3/4, 1", 1-1/2; 10-32 x 1/2, 3/4, 1", 1-1/2; 1/4-20 x 3/4, 1", 1-1/4, 1-1/2 Flat - 6-32 x 3/8, 1/2, 3/4, 1", 1-1/2; 8-32 x 1/2, 3/4, 1", 1-1/2; 10-32 x 1/2, 3/4, 1", 1-1/2; 1/4-20 x 1, 1-1/2 Nuts - 6-32, 8-32, 10-32, 1/4-20</p>	<p>020-816 Clevis Pins and Clips Pg. 81</p>  <p>Contains 173 Standard & Universal Clevis Pins & Clips 255-044, 054, 064, 074, 076, 084, 086, 106, 126, 208, 221, 224, 226, 228, 231, 235, 236, 237, 239, 241, 242, 244, 246, 251; Hitch Pins - 255-303, 307, 310, 311, 316 Cotter Pins - 1/16 x 1/2; 3/32 x 3/4; 1/8 x 1</p>	<p>020-840 Metric Expansion Plugs Pg. 165</p>  <p>Contains 180 Metric Standard & Cup Types 261-014, 024, 026, 046, 064, 090, 100, 107, 109, 114, 117, 124, 126, 132, 138, 145, 146, 149, 150, 155, 161, 165, 177, 182, 184, 185, 186, 188</p>	
<p>020-807 Tapping Screws Pg. 112</p>  <p>Contains 1450 Pan & Oval Slot Tapping Screws Pan - 6 x 3/8, 1/2, 3/4, 1", 1-1/4; 8 x 3/8, 1/2, 3/4, 1", 1-1/4, 1-1/2; 10 x 1/2, 3/4, 1", 1-1/4, 1-1/2; 12 x 3/4, 1", 1-1/4; 14 x 1 1-1/2; Oval - 6 x 1/2, 3/4, 1"; 8 x 1/2, 3/4, 1"; 10 x 3/4, 1", 1-1/4; 12 x 1-1/2</p>	<p>020-817 Snap Rings Pg. 174</p>  <p>Contains 705 Snap Rings - 50 Sizes Complete coverage 268-222 to 724</p>	<p>020-841 Metric Expansion Plugs Pg. 164</p>  <p>Contains 150 Metric Cup & Shallow Cup Types 261-100, 107, 109, 126, 132, 138, 145, 146, 149, 150, 155, 161, 162, 165, 177, 182, 184, 185, 186, 188, 326, 347, 364, 367, 377</p>	
<p>020-808 Tapping Screws Pg. 113</p>  <p>Contains 650 Hex Head Tapping Screws & Fender Washers Complete coverage of Hex Head Tapping Screws Fender Washers - 162-394, 395, 396, 397, 398, 399</p>	<p>020-818 Engine Studs and Nuts Pg. 207</p>  <p>Contains 295 Engine Studs & Nuts Studs - 264-018, 024, 032, 048, 049, 060, 066, 086, 088, 094, 096, 134, 150 Metric Studs - 264-231, 328, 335, 338, 346, 443, 450, 451 Nuts - 264-953, 954, 955, 956, 958, 959, 960, 961 Metric Nuts - 670-006, 008, 010</p>	<p>020-842 Metric Cap Screws and Nuts Pgs. 32 37</p>  <p>Contains 535 Metric Cap Screws & Nuts 608-139, 198, 201, 203, 205, 267, 270, 272, 274, 276, 278, 279, 311, 314, 316, 318, 320, 321, 322, 324, 326, 328, 370, 372, 374, 376, 378; 670-004, 005, 006, 008, 010</p>	

Note: Contents of assortments subject to change with market.

‘SUPER-SERVICE’ ASSORTMENT BODY BOLT & NUT
ASSORTIMENTS DE ‘SUPER-SERVICE’ DE CARROSSERIE – BOULONS ET ÉCROUS

No. 020-834
BODY BOLT and
NUTS ASSORTMENT

■ 327 Pieces

Body Bolt and Nuts Assortment		
Size	Description	Qty
240-614	1/4-20	20
240-616	5/16-18	20
240-617	5/16-18 L	25
240-618	3/8-16 L	10
240-708	#8	12
240-709	#8 L	20
240-710	#10	10
241-606	M6 x 1.0	20
241-607	M6 x 1.0 L	12
241-608	M8 x 1.25 L	10
241-609	M8 x 1.25	10
245-322	M6 x 22mm	10
245-400	M4.2 x 20	20
245-407	M6 x 1.0 x 25	25
245-440	M8 x 1.25 x 30	15
245-525	M8 x 25mm	10
245-610	1/4-20 x 1 1/4	8
245-615	5/16-18 x 7/8	20
245-616	5/16-18 x 1	30
245-620	3/8-16 x 1	10
245-630	3/8-16 x 1 1/2	10

See pages 141 & 142.

No. 020-836
JIS 10.9 METRIC
FLANGE BOLTS and NUTS
ASSORTMENT

■ 182 Pieces

JIS 10.9 Metric Flange Bolts and Nuts Assortment		
Part No.	Description	Qty
611-270	M6 x 1.0 x 16mm	8
611-272	M6 x 1.0 x 20mm	8
611-274	M6 x 1.0 x 25mm	8
611-276	M6 x 1.0 x 30mm	8
611-278	M6 x 1.0 x 40mm	4
611-314	M8 x 1.25 x 16mm	6
611-316	M8 x 1.25 x 20mm	6
611-318	M8 x 1.25 x 25mm	6
611-320	M8 x 1.25 x 30mm	6
611-321	M8 x 1.25 x 35mm	4
611-322	M8 x 1.25 x 40mm	4
611-324	M8 x 1.25 x 50mm	4
611-326	M8 x 1.25 x 60mm	4
611-366	M10 x 1.25 x 20mm	4
611-370	M10 x 1.25 x 30mm	4
611-372	M10 x 1.25 x 40mm	4
611-374	M10 x 1.25 x 50mm	4
244-996	Metric Flange Nut M6 x 1.0	30
244-997	Metric Flange Nut M8 x 1.25	30
244-998	Metric Flange Nut M10 x 1.25	30

See pages 38 & 39.



OTHER ASSORTMENTS
AUTRES ASSORTIMENTS

OTHER ASSORTMENTS Order by Stock Number					
Part No.	Description	Ref. Page #	Part No.	Description	Ref. Page #
020-853	Axle Key Stock	178	020-889	Booster Clamps (500 amp)	194
020-855	Socket Set Screws	75	020-900	Threaded Rods	89
020-856	Thread Cutting Screws	110	020-901	Grease Fittings (Inch)	244
020-857	Fibre Washers	97	020-902	Grease Fittings (Metric)	244
020-858	Socket Keys	74	020-907	Drill Bits (4 pcs.)	225
020-860	Utility Springs (Extension)	216	020-910	Drill Bits (10 pcs.)	225
020-861	Utility Springs (Compression)	216	020-913	Drill Bits (13 pcs.)	225
020-862	Axle Keys	179	020-914	Drill Bits (14 pcs.)	225
020-865	Nylon Licence Plate Bolts	144	020-921	Drill Bits (21 pcs.)	225
020-866	Cotter Pins	78	020-929	29 Pcs Bit Kit	132
020-867	Licence Plate Bolts	144	8020-922	Colour Quick Change Bit Kit	129
020-868	Marine Terminals	193	8020-923	Nut Setter and Bit Kit	130
020-869	Battery Terminals	193	8020-930	Piece Ultimate Bit Kit	130
020-870	Emergency Terminals	193	8020-937	Colour-Coded Counter Top Bit Jar	131
020-875	Machinery Bushings	98	8020-941	Color Coded Pocket Tool Kits	131
020-878	Carburetor Springs	214	8020-943	Colour-Coded Bits	131
020-879	Alligator Test Clips	192	8020-944	Screwdriver Bit Set	132
020-882	Spring Expanders	199	8020-987	Assorted Nutsetters Kits	132
020-886	Lock Washers	95	8020-988	Assorted Hex Magnetic Nutsetters	132

**PLASTIC ASSORTMENT KITS
ASSORTIMENTS DE PLASTIQUE**

- Sealed cover molded with the base to prevent part migration
- Temperature resistant nylon
- Two-part handle to prevent accidental opening
- Coin-bottom compartments for easy access
- Product Identification chart available inside the case

**No. 021-599
EMPTY ASSORTMENT BOX**



**No. 021-605
WOOD SCREW ORGANIZER**

- 530 / PK
- No. 6-10



**No. 021-610
BOLT-and-NUT ORGANIZER**

- 529 / PK
- 1/4-3/8



**No. 021-600
S.S. MARINE KIT #1
BOLTS, NUTS &
WASHERS**

- 514 Pieces
- Contains 514 pieces, 3 types of bolts, 4 types of nuts & 3 types of washers



**No. 021-601
S.S. MARINE KIT #2
SCREWS, WASHERS
& BITS**

- 648 Pieces
- Contains 648 pieces, 3 types of screws, 2 types of driver bits & washers

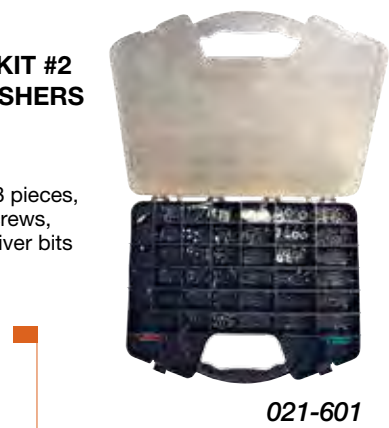

MERCHANDISERS PRÉSENTOIRS

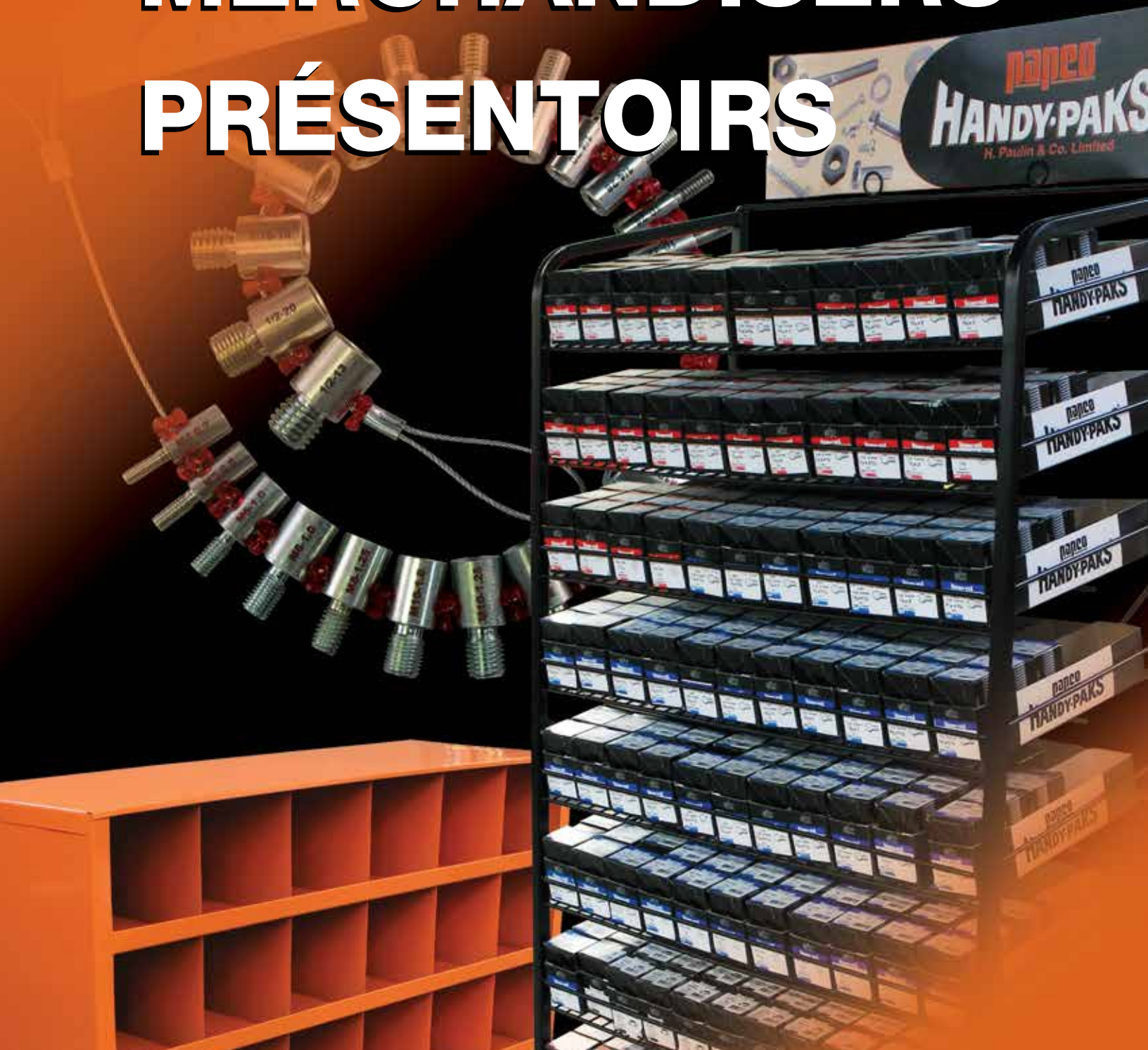

BOLT BINS

MOD-U-BIN

TILT BINS

BULK BINS

PLASTIC SERVICE BINS

AUTO-TECH STARTER KIT

BOLT BIN MERCHANDISERS (IMPERIAL & METRIC)

HANDY-PAKS® MERCHANDISER

MEGA-PAK® MERCHANDISER

AUTO FASTENER MERCHANDISER

BODY SHOP MERCHANDISER

**BOLT BINS
BACS DE BOULONS**

Store your Cap Screws, Nuts and other fasteners in these modern, all-steel Papco[®] Bolt Bins. Every item is easy to see - your stock is kept clean, neat and always available.

No. 022-017 (EMPTY)

- 40 Compartments.
- Compartments Size: 4-1/2" x 4-1/2" x 12"
- 36" W x 24" H x 12" D - Overall Dimensions
- Shipping Weight 50 lbs.



022-017

No. 022-018 (EMPTY)

- 42 Compartments.
- Compartments Size: 5-3/8" x 5-7/16" x 12"
- 36" W x 42" H x 12" D - Overall Dimensions
- Shipping Weight 70 lbs.



022-018

No. 022-019 (EMPTY)

- 72 Compartments.
- Compartments Size: 4-1/2" x 4-1/2" x 12"
- 36" W x 42" H x 12" D - Overall Dimensions
- Shipping Weight 80 lbs.



022-019

*Size: 36" W x 42" H x 12" D
Base not included*

FEATURES

- **OPTIONAL STEEL DOORS**
with Chrome Handles and Magnetic Catches.
No. 022-023 for Bolt Bin No. 022-017
No. 022-025 for Bolt Bin No. 022-018 and 019
- **HEAVY GAUGE STEEL**
Welded Construction.
- **SAFETY BIN LIPS**
Avoid Spillage.
- **BAKED FINISH**
- **OPTIONAL STEEL BASE**
4 Inches High, Black finish.
022-027 Base fits either model.



**MOD-U-BIN
BACS MOD-U-BIN**

Build a Papco[®] Bolt Bin as large as you need. New modular design allows you to mount additional bins to the top, bottom or sides.

- Heavy gauge steel construction.
- 12 Large hand size compartments.
- Baked orange enamel finish.
- Label holder rails.
- Mount anywhere, on the wall, on a workbench or on the floor.

No. 022-020 (EMPTY)

- 12 Compartments.
- Compartments Size: 4-1/4" x 5-1/2" x 6-1/4".
- 17" W x 16-1/2" H x 6-1/4" D.
- Shipping Weight 7 lbs.



022-020



BOLT-N-NUT CABINET ASSORTMENTS ASSORTIMENT D'ÉCROUS ET BOULONS POUR CABINET

The Papco® Bolt-n-Nut Cabinet was developed for Service Stations, Garages, Car Dealers, Body Shops and many other fastener users. Each compact space-saving cabinet features:

No. 022-086 (EMPTY)

- All steel construction.
- 18 man-size, no-spill drawers (11-1/4" L x 5-1/2" W x 3" D).
- Colour-coded labels for ease of identification.
- Full width handles.
- Multi-divisible drawers for future additions.
- Optional steel drawer dividers No. 022-088, Standard package contains 12 dividers.
- Can be mounted on bench or placed in a standard three foot shelf.



Size: 34" W x 11" H x 11-5/8" D

BOLT-N-NUT CABINET MERCHANDISERS PRÉSENTOIRS D'ÉCROUS ET BOULONS POUR CABINET

No. 022-084

GRADE 5 PLATED BOLTS-N-NUTS

Includes 47 items as listed below, one empty cabinet No. 022-086, labels and instructions.

No. 022-085

GRADE 5 BARE BOLTS-N-NUTS

Includes 47 items as listed below, one empty cabinet No. 022-086, labels and instructions.

No. 022-087

GRADE 8.8 PLATED METRIC FASTENERS

Includes 52 items as listed below, one empty cabinet No. 022-086, labels and instructions.

No. 022-084 Plated

No. 022-085 Bare

UNC Grade 5 Cap Screws		UNF Grade 5 Cap Screws		Round Head Stove Bolts	
100	1/4 x 3/4	100	1/4 x 3/4	100	3/16 x 1
100	1/4 x 1	100	1/4 x 1	100	3/16 x 1-1/2
100	1/4 x 1-1/2	100	1/4 x 1-1/2	100	1/4 x 1
100	5/16 x 3/4	100	5/16 x 3/4	UNC Hex Nuts	
100	5/16 x 3/4	100	5/16 x 1	100	1/4
100	5/16 x 1	100	5/16 x 1-1/2	100	5/16
100	5/16 x 1-1/2	100	3/8 x 1	100	3/8
100	3/8 x 1	100	3/8 x 1-1/2	50	7/16
100	3/8 x 1-1/2	100	3/8 x 2	50	1/2
100	3/8 x 2	Lock Washers		UNF Hex Nuts	
50	7/16 x 1-1/2	100	1/4	100	1/4
50	7/16 x 2	100	5/16	100	5/16
50	1/2 x 1-1/2	100	3/8	100	3/8
50	1/2 x 2	100	7/16	Flat Washers	
50	1/2 x 2-1/2	100	1/2	100	1/4
		Cotter Pins		100	5/16
		100	3/32 x 1-1/2	100	3/8
		100	1/8 x 1-1/2	100	7/16
		100	1/8 x 2	100	1/2

No. 022-087 Plated

Grade 8.8 Cap Screws		Grade 8.8 Cap Screws		Fine & Extra Fine Cap Screws & Nuts	
100	M4 x 16	100	M8 x 20	10	M8 x 1
100	M5 x 12	100	M8 x 25	10	M10 x 1
100	M5 x 16	100	M8 x 30	10	M10 x 1.25
100	M5 x 20	50	M8 x 40	10	M12 x 1.25
100	M5 x 25	50	M8 x 50	10	M12 x 1.5
100	M6 x 12	25	M8 x 60	Stove Bolts	
100	M6 x 16	25	M8 x 70	100	M4 x 6
100	M6 x 20	50	M10 x 30	100	M4 x 12
100	M6 x 25	50	M10 x 40	100	M5 x 10
100	M6 x 30	50	M10 x 50	100	M5 x 16
100	M6 x 35	25	M10 x 60	100	M6 x 10
100	M8 x 12	25	M10 x 70	100	M6 x 16
100	M8 x 16	25	M10 x 70	100	M6 x 20
Lock Washers		Hex Nuts		Flat Washers	
100	4 mm	100	M8 x 40	100	4 mm
100	5 mm	100	M8 x 50	100	5 mm
100	6 mm	100	M8 x 60	100	6 mm
100	8 mm	100	M8 x 40	100	8 mm
100	10 mm	100	M8 x 40	100	10 mm

**TILT BINS
BACS INCLINABLES EN PLASTIQUE**

Clear, plastic tilt-out bins in a stackable plastic cabinet.

ORDER BY STOCK NUMBER

Stock No.	Description	W	D	H
022-253	3 Compartment Tilt-Bin	23-5/8	7-3/4	9-1/2
022-254	4 Compartment Tilt-Bin	23-5/8	6-5/8	8-1/8
022-255	5 Compartment Tilt-Bin	23-5/8	5-1/4	6-1/2
022-256	6 Compartment Tilt-Bin	23-5/8	3-5/8	4-1/2
022-259	9 Compartment Tilt-Bin	23-5/8	2-1/2	3-5/16

022-255

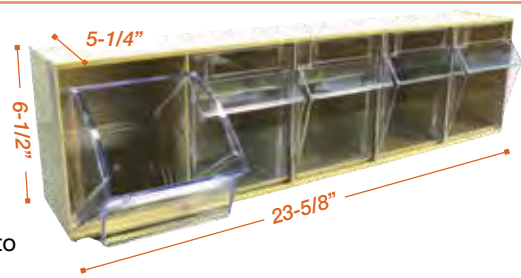

**BULK BINS
GRANDS BACS EN PLASTIQUE**

Durable Polypropylene, coloured bins are stackable and can be divided to hold more than one part.

ORDER BY STOCK NUMBER

Standard Package 12 Bins

Stock No.	Colour	W	D	H
022-263	Blue	6-5/8	18	4
022-264	Red	6-5/8	18	4
022-265	Yellow	6-5/8	18	4
022-266	Green	6-5/8	18	4
022-267	Orange	6-5/8	18	4
022-268	Blue	6-5/8	11-5/8	4
022-269	Red	6-5/8	11-5/8	4
022-270	Yellow	6-5/8	11-5/8	4
022-271	Black	Bin dividers		

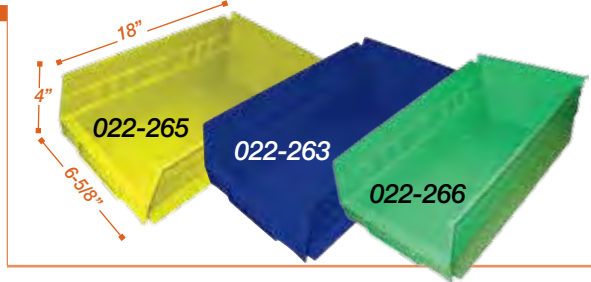

**PLASTIC SERVICE BINS
BACS DE SERVICE EN PLASTIQUE**

- **Durable**
Frames are of heavy steel construction for long life.
- **Easy to remove**
Carry bin to the job.
- **Easy to clean**
Individual hook-on bins lift out.
- **Easy to re-arrange**
Add new stock sizes as required.
- **Completely visible**
Bins have forward tilt.
- **Completely accessible**
Coin drawer bin bottom for easy parts removal.
- **Easy to service**
Stock can be checked and refilled.
- **Versatile**
Sold empty - Choice of 5 sizes of racks.
Free label service.

No. 022-040

Individual hook-on-plastic bins
Empty service bin
7" L x 3-3/4" W x 2-3/4" D



022-040

No. 022-044

50 Bins and frame
23" H x 41" W x 8" D



022-044

No. 022-041

10 Bins and frame
10" H x 21-1/2" W x 8" D



022-041

No. 022-045

100 Bins and frame
56" H x 41" W x 12" D

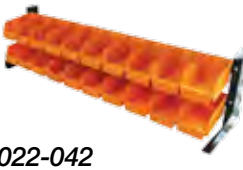

022-042

No. 022-042

20 Bins and frame
10" H x 41" W x 8" D



022-043

No. 022-043

25 Bins and frame
23" H x 21-1/2" W x 8" D



022-045

**BOLT BIN ASSORTMENTS
ASSORTIMENTS DE BOULONS**

These assortments include a set of bolt bin stock labels with space for inventory control or price tags; a 'Papco[®]' measurement and decimal equivalents chart and popular fastener order forms.

You can also purchase 'Papco[®]' bolt bins empty and make up your own custom assortments. You have the option of ordering the Doors and Base as extra items. As your requirements grow, you can add more bolt bins to store other fasteners and supplies.

No. 022-021

PLATED GRADE 5 CAP SCREWS AND NUTS



72 Popular Sizes - Over 4,750 Pieces.

UNC Cap Screws		UNC Cap Screws		UNF Cap Screws		UNF Cap Screws		UNC Hex Nuts	
100	1/4 x 3/4	50	7/16 x 1-1/2	100	1/4 x 1	25	5/8 x 3	20	7/8
100	1/4 x 1	50	7/16 x 2	100	1/4 x 1-1/2	25	5/8 x 4	20	1
100	1/4 x 1-1/2	50	7/16 x 3	100	5/16 x 1	20	3/4 x 3	UNF Hex Nuts	
100	5/16 x 3/4	50	1/2 x 1	100	5/16 x 1-1/2	20	3/4 x 4	200	1/4
100	5/16 x 1	50	1/2 x 1-1/2	100	5/16 x 2	UNC Hex Nuts		200	5/16
100	5/16 x 1-1/2	50	1/2 x 2	100	3/8 x 1	300	1/4	200	3/8
100	5/16 x 2	50	1/2 x 2-1/2	100	3/8 x 2	200	5/16	100	7/16
100	3/8 x 1	50	1/2 x 3	50	7/16 x 1-1/2	200	3/8	50	1/2
500	3/8 x 1-1/2	50	1/2 x 4	50	1/2 x 2	50	7/16	25	9/16
100	3/8 x 2	25	9/16 x 2	50	1/2 x 3	50	1/2	25	5/8
100	3/8 x 2-1/2	25	5/8 x 2	50	1/2 x 4	25	9/16	20	3/4
100	3/8 x 3	25	5/8 x 2-1/2	25	9/16 x 2	25	5/8	-	-
-	-	25	5/8 x 3	25	5/8 x 2	20	3/4	-	-



Size: 36" W x 42" H x 12" D
Doors and Base are optional extras

022-021

**BOLT BIN ASSORTMENTS
ASSORTIMENTS DE BOULONS**

No. 022-022

**GRADE 5 UNC CAP/SCREWS
AND NUTS - ZINC PLATED**



40 Popular Sizes - Over 4,000 Pieces.

UNC Cap Screws		UNC Cap Screws		UNC Hex Nuts	
100	1/4 x 3/4	25	5/8 x 2	200	1/4
100	1/4 x 1	25	5/8 x 3	100	5/16
100	1/4 x 1-1/2	UNF Cap Screws		100	3/8
100	5/16 x 3/4	100	1/4 x 1	100	7/16
100	5/16 x 1	100	1/4 x 1-1/2	100	1/2
100	5/16 x 1-1/2	100	5/16 x 3/4	50	9/16
200	3/8 x 1	200	5/16 x 1	25	5/8
200	3/8 x 1-1/2	100	5/16 x 1-1/2	UNF Hex Nuts	
200	3/8 x 2	100	3/8 x 1	200	1/4
100	7/16 x 1-1/2	100	3/8 x 1-1/2	100	5/16
100	1/2 x 1-1/2	100	3/8 x 2	100	3/8
100	1/2 x 2	100	7/16 x 1-1/2	100	7/16
100	1/2 x 2-1/2	50	1/2 x 2	100	1/2
25	9/16 x 1-1/2	50	1/2 x 2-1/2	-	-
25	9/16 x 2	-	-	-	-



022-022

Size: 36" W x 24" H x 12" D
Doors and base are optional extras

**AUTO-TECH STARTER ASSORTMENTS
ASSORTIMENTS DE DÉPART AUTO-TECH**

**GRADE 5 BOLT ASSORTMENT
- ZINC PLATED**

No. 022-600

- 2380 pieces
- Bin included
- 1/4" - 1/2" Dia.



022-600

Hex Head Cap Screws GR 5 UNC		
Part No.	Size	Qty
075-307	1/4 x 3/4	100
075-309	1/4 x 1	100
075-311	1/4 x 1 1/4	100
075-313	1/4 x 1 1/2	50
075-316	1/4 x 2	50
075-442	5/16 x 3/4	100
075-444	5/16 x 1	100
075-446	5/16 x 1 1/4	100
075-448	5/16 x 1 1/2	50
075-451	5/16 x 2	50
075-487	3/8 x 3/4	50
075-489	3/8 x 1	50
075-493	3/8 x 1 1/2	50
075-496	3/8 x 2	50
075-498	3/8 x 2 1/2	50
075-534	7/16 x 1	25
075-538	7/16 x 1 1/2	25
075-541	7/16 x 2	10
075-543	7/16 x 2 1/2	10
075-545	7/16 x 3	10
075-583	1/2 x 1 1/2	10
075-586	1/2 x 2	10
075-588	1/2 x 2 1/2	10
075-590	1/2 x 3	10
075-594	1/2 x 4	10

Finished Hex Nuts GR 5 UNC		
Part No.	Size	Qty
087-014	1/4 - 20	100
087-016	5/16 - 18	100
087-018	3/8 - 16	100
087-020	7/16 - 14	50
087-022	1/2 - 13	50

B.S. S.A.E. Steel Washers		
Part No.	Size	Qty
154-014	1/4	100
154-016	5/16	100
154-018	3/8	100
154-020	7/16	50
154-022	1/2	50

Spring Lock Washers		
Part No.	Size	Qty
157-014	1/4	100
157-016	5/16	100
157-018	3/8	100
157-020	7/16	50
157-022	1/2	50

40 Compartment Bolt Bin w/Labels		
Part No.	Qty	
022-017	1	

**ZINC PLATED GRADE 8.8 METRIC
BOLT ASSORTMENT**

No. 022-602

- 2150 pieces
- Bin included
- 5mm - 12mm Dia.



022-602

8.8 Metric Hex Head Cap Screws		
Part No.	Size	Qty
608-198	M5 x 12	50
608-201	M5 x 16	50
608-203	M5 x 20	50
608-205	M5 x 25	50
608-267	M6 x 12	50
608-270	M6 x 16	50
608-272	M6 x 20	50
608-274	M6 x 25	50
608-276	M6 x 30	50
608-314	M8 x 16	50
608-316	M8 x 20	50
608-318	M8 x 25	50
608-320	M8 x 30	50
608-322	M8 x 40	50
608-366	M10 x 20	25
608-368	M10 x 25	25
608-370	M10 x 30	25
608-372	M10 x 40	25
608-374	M10 x 50	25
608-412	M12 x 25	25
608-414	M12 x 30	25
608-415	M12 x 35	25
608-416	M12 x 40	25
608-418	M12 x 50	25

8 Metric Hex Nuts (Coarse)		
Part No.	Size	Qty
670-005	M5 - 0.80	100
670-006	M6 - 1.00	100
670-008	M8 - 1.25	100
670-010	M10 - 1.50	50
670-012	M12 - 1.75	50

8 Metric Flat Washers		
Part No.	Size	Qty
730-005	5 mm	100
730-006	6mm	100
730-008	8mm	100
730-010	10mm	50
730-012	12mm	50

8 Metric Lock Washers		
Part No.	Size	Qty
740-005	5mm	100
740-006	6mm	100
740-008	8mm	100
740-010	10mm	50
740-012	12mm	50

40 Compartment Bolt Bin w/Labels		
Part No.	Qty	
022-017	1	

PRODUCT REFILL ASSORTMENTS

- Includes stock & labels
- Bins not included

No. 022-600R

No. 022-602R

BOLT BIN ASSORTMENTS ASSORTIMENTS DE BOULONS

No. 022KIT-01



**GRADE 5 UNC PLATED
FARM PACK ASSORTMENT**

Size	Qty	Size	Qty	Size	Qty	Size	Qty
1/4 x 1/2	25	5/16 x 2-1/2	25	1/2 x 1	10	5/8 x 2-1/2	10
1/4 x 1	25	3/8 x 3/4	25	1/2 x 1-1/2	10	5/8 x 3	10
1/4 x 1-1/2	25	3/8 x 1	25	1/2 x 2	10	5/8 x 4	10
1/4 x 2	25	3/8 x 1-1/2	25	1/2 x 2-1/2	10	3/4 x 1-1/2	5
5/16 x 3/4	25	3/8 x 2	25	1/2 x 3	10	3/4 x 2	5
5/16 x 1	25	3/8 x 2-1/2	25	1/2 x 4	10	3/4 x 2-1/2	5
5/16 x 1-1/2	25	3/8 x 3	25	5/8 x 1-1/2	10	3/8 x 3	5
5/16 x 2	25	3/8 x 4	25	5/8 x 2	10	3/8 x 4	5

Size	Qty	Nuts	Qty	Lockwashers	Qty	Flat Washers
1/4	200		200		200	
5/16	200		200		200	
3/8	200		200		200	
1/2	50		50		50	
5/8	25		25		25	
3/4	20		20		20	

No. 022KIT-08



**GRADE 8 UNC PLATED BOLT & NUT
ASSORTMENT - YELLOW ZINC PLATED**



No. 022KIT-01
Contains 2,620 pcs.
42" H x 36" W x 12" D
Base not included

No. 022KIT-02



**METRIC 8.8 BOLT & NUT
ASSORTMENT - ZINC PLATED**

Size	Qty	Size	Qty	Size	Qty	Size	Qty
M6 x 12	100	M8 x 60	25	M12 x 25	25	M16 x 60	10
M6 x 25	100	M10 x 20	25	M12 x 35	25	M16 x 70	10
M6 x 35	25	M10 x 25	50	M12 x 50	25	M16 x 100	10
M6 x 50	25	M10 x 35	50	M12 x 60	25	M20 x 40	5
M8 x 20	100	M10 x 50	25	M12 x 70	25	M20 x 50	5
M8 x 25	100	M10 x 60	25	M12 x 100	10	M20 x 60	5
M8 x 35	25	M10 x 70	25	M16 x 35	10	M20 x 70	5
M8 x 50	100	M10 x 100	10	M16 x 50	10	M20 x 100	5

Size	Qty	Nuts	Qty	Lockwashers	Qty	Flat Washers
M6	200		200		200	
M8	300		200		200	
M10	200		200		200	
M12	50		100		100	
M16	25		25		25	
M20	20		25		25	

No. 022KIT-03



**METRIC 10.9 BOLT & NUT
ASSORTMENT - ZINC PLATED**



No. 022KIT-02
Contains 3,315 pcs.
42" H x 36" W x 12" D
Base not included

PRODUCT REFILL ASSORTMENTS

- Includes stock & labels
- Bins not included

No. 022KIT-01R

No. 022KIT-02R

No. 022KIT-03R

No. 022KIT-08R

**BRAKE / FUEL LINE REPAIR CENTER
RÉPARATIONS DES CANALISATIONS DE FREINS ET DE CARBURANT**

No. 022-550

THE EVOLUTION OF FUEL LINE REPAIR

Our 'No Tools Required' Fuel Line Repair system now enables the installer to utilize their most valuable tools: their hands.

A comprehensive application manual will be included with the Brake/Fuel Line Repair Center.



Features & Benefits



Innovative

'Posi-Hold' bead end design enables the installer to connect fittings by hand. No costly installation tools are required and the nylon tubing does not require pre-heating.

Connections

It meet or exceed the 200 p.s.i. rating of Nylon 12 tubing when used in conjunction with the appropriate size tubing and 360° seal clamps.

Replace

For the damaged sections, fabricate complete fuel lines, repair main feed, return and vent fuel lines in the time it takes to set up most installation tools.



POLY-V Coated Brake Lines

Included in the Brake/Fuel Line Repair Center, Papcoflex **POLY-V** coated brake lines feature a durable polyvinyl fluoride finish that resists corrosion and abrasions from road debris, offering up to 30 times the protection over our standard steel brake line.

To complement this premium brake line, all related brake line fittings, adaptors, unions, and bleeder screws will be offered in the Brake/Fuel line Repair Center providing one destination point for your customers. POP signage will also outline the correct size, thread type and the correct adaptors/unions for each brake line diameter.



61"

Signage & hooks included
Gondolas NOT included



48"

**PLEASE REFER TO CURRENT BRAKE / FUEL LINE REPAIR CENTER FLYER
(FORM No. BFL-115) FOR CONTENT LISTING**

HANDY-PAKS® MERCHANDISER PRÉSENTOIRS HANDY-PAKS®

HANDY-PAKS® MERCHANDISERS

- Sturdy, heavy gauge, reinforced steel.
- Use on work bench or hang on wall.
- Colourful - Durable - Efficient.
- Retail prices on each pak - Fastener fact chart.
- Handy bolt measuring gauge included.
- Inventory control strips.



18-1/2" W x 14-3/4" H

Note: Empty Metal Merchandiser Rack No. 022-070 available to make up your own Merchandiser of any 35 Papco® Handy-Paks®.

No. 022-061 PLATED FASTENERS MERCHANDISER

ORDER BY STOCK NUMBER

Stock No.		Size	Stock No.		Size	Stock No.	Size	Stock No.	Size
Plated Grade 5 Cap Screws			Hex Nuts			Lock Washers		Cotter Pins	
UNC	UNF		UNC	UNF					
023-003	023-103	1/4 x 3/4	023-201	023-221	1/4	023-343	1/4	023-709	3/32 x 1
023-005	023-105	1/4 x 1	023-202	023-222	5/16	023-344	5/16	023-716	1/8 x 2
023-007	023-107	1/4 x 1-1/2	023-203	023-223	3/8	023-345	3/8		
023-016	023-116	5/16 x 3/4				S.A.E. Washers		R.H. Stove Bolts	
023-020	023-120	5/16 x 1-1/2				023-323	1/4	023-503	3/16 x 1
023-031	023-131	3/8 x 1				023-324	5/16	023-511	1/4 x 3/4
023-033	023-133	3/8 x 1-1/2				023-325	3/8	023-512	1/4 x 1
023-035	023-135	3/8 x 2							

No. 022-063 PLATED BODY SHOP FASTENERS MERCHANDISER

ORDER BY STOCK NUMBER

Stock No.	Size	Stock No.	Size	Stock No.	Size	Stock No.	Size	Stock No.	Size
Tapping Screws Pan Head		Tapping Screws Oval Head		Tapping Screws Oval Phillips Head		Machine Screws Round Head		Hex Nuts	
023-604	6 x 3/8	023-635	6 x 1/2	023-696	6 x 3/4	023-412	8-32 x 1	023-460	6-32
023-605	6 x 1/2	023-644	8 x 3/4	023-687	8 x 3/4	023-419	10-32 x 1	023-461	8-32
023-612	8 x 1/2	023-649	10 x 3/4	023-692	8 x 1-1/2	Machine Screws Oval Head		023-462	10-32
023-614	8 x 3/4			023-694	10 x 1	023-433	6-32 x 1/2		
023-618	10 x 1/2	Tapping Screws Hex Head		Machine Screws Round Head		023-440	8-32 x 1/2		
023-619	10 x 3/4	023-665	8 x 1/2	023-403	6-32 x 1/2	023-442	8-32 x 1		
023-621	10 x 1	023-668	10 x 5/8	023-405	6-32 x 1	023-449	10-32 x 1	Fender Washers	
023-629	14 x 1	023-673	14 x 3/4	023-410	8-32 x 1/2			023-395	1/4
		023-675	14 x 1					023-396	5/16
		023-677	5/16 x 1					023-397	5/16L

No. 022-064 PLATED CAP SCREWS AND NUTS MERCHANDISER

ORDER BY STOCK NUMBER

Stock No.		Size	Stock No.		Size	Stock No.		Size
Plated Grade 5 Cap Screws			Plated Grade 5 Cap Screws			Hex Nuts		
UNC	UNF		UNC	UNF		UNC	UNF	
023-003	023-103	1/4 x 3/4	023-035	023-135	3/8 x 2	023-201	023-221	1/4
023-005	023-105	1/4 x 1	023-044	023-144	7/16 x 1-1/2	023-202	023-222	5/16
023-007	023-107	1/4 x 1-1/2	023-055	023-155	1/2 x 1-1/2	023-203	023-223	3/8
023-016	023-116	5/16 x 3/4	023-057	023-157	1/2 x 2	023-204	023-224	7/16
023-018	023-118	5/16 x 1	023-059	023-159	1/2 x 2-1/2	023-205	023-225	1/2
023-020	023-120	5/16 x 1-1/2						
023-031	023-131	3/8 x 1						
023-033	023-133	3/8 x 1-1/2						

For complete listing of 'Metric Handy-Paks®' see pages 25 to 27.

HANDY-PAKS[®] MERCHANDISER
PRÉSENTOIRS HANDY-PAKS[®]

HANDY-PAKS[®] MERCHANDISERS

No. 022-067

Contains 792 Handy-Paks[®], rack and sign, 132 sizes of Cap Screws, Nuts, Washers, Cotter Pins, Stove Bolts, etc.

Uniform Priced Packages of Fast-Moving Hardware Items

- All Bright Plated Material.
- No Broken Boxes.
- Good For Regular Stock.
- Ideal For Assortment Refills.
- Best Value.
- Fully Illustrated, Colour-Coded Labels.

Papco[®] Handy-Paks are the most modern method of stocking fasteners. They contain the most popular sizes of Bolts, Nuts, Screws and Washers as well as the best sizes of replacement parts. The available merchandisers are designed to give maximum coverage for a minimum investment.



No. 022-067

MERCHANDISER CONTENTS

ORDER BY STOCK NUMBER

Stock No.	Size	Qty.	Part No.	Size	Qty.	Stock No.	Size	Qty.	Part No.	Size	Qty.
UNF Grade 5 Cap Screws			UNC Grade 5 Cap Screws			UNC Hex Nuts			023-307	1/2	6
023-101	1/4 x 1/2	6	023-018	5/16 x 1	12	023-203	3/8	12	023-309	5/8	6
023-103	1/4 x 3/4	6	023-019	5/16 x 1-1/4	6	023-204	7/16	12	Cotter Pins		
023-105	1/4 x 1	6	023-020	5/16 x 1-1/2	12	023-205	1/2	6	023-703	1/16 x 1	6
023-107	1/4 x 1-1/2	6	023-022	5/16 x 2	6	023-207	5/8	6	023-705	1/16 x 1-1/2	6
023-109	1/4 x 2	6	023-029	3/8 x 3/4	6	Round Head Stove Bolts			023-709	3/32 x 1	6
023-116	5/16 x 3/4	6	023-031	3/8 x 1	12	023-502	3/16 x 3/4	6	023-710	3/32 x 1-1/4	6
023-118	5/16 x 1	12	023-032	3/8 x 1-1/4	12	023-503	3/16 x 1	6	023-711	3/32 x 1-1/2	6
023-119	5/16 x 1-1/4	6	023-033	3/8 x 1-1/2	12	023-505	3/16 x 1-1/2	6	023-715	1/8 x 1	6
023-120	5/16 x 1-1/2	6	023-035	3/8 x 2	12	023-511	1/4 x 3/4	6	023-716	1/8 x 1-1/4	6
023-122	5/16 x 2	6	023-037	3/8 x 2-1/2	6	023-512	1/4 x 1	6	023-717	1/8 x 1-1/2	12
023-131	3/8 x 1	6	023-042	7/16 x 1	6	Lock Washers			023-718	1/8 x 2	12
023-132	3/8 x 1-1/4	6	023-043	7/16 x 1-1/4	6	023-342	3/16	6	023-722	5/32 x 1-1/2	6
023-133	3/8 x 1-1/2	6	023-044	7/16 x 1-1/2	6	023-343	1/4	6	023-723	5/32 x 2	6
023-135	3/8 x 2	6	023-046	7/16 x 2	6	023-344	5/16	12	Hex Machine Screw Nuts		
023-137	3/8 x 2-1/2	6	023-048	7/16 x 2-1/2	6	023-345	3/8	12	023-462	10-32	6
023-144	7/16 x 1-1/2	6	023-053	1/2 x 1	6	023-346	7/16	6	Pan Head Sheet Metal Screws		
023-146	7/16 x 2	6	023-054	1/2 x 1-1/4	6	023-347	1/2	6	023-605	6 x 1/2	6
023-153	1/2 x 1	6	023-055	1/2 x 1-1/2	6	023-349	5/8	6	023-612	8 x 1/2	6
023-155	1/2 x 1-1/2	6	023-057	1/2 x 2	6	S.A.E. Washers			023-614	8 x 3/4	6
023-157	1/2 x 2	6	023-059	1/2 x 2-1/2	6	023-323	1/4	12	023-616	8 x 1	6
023-159	1/2 x 2-1/2	6	UNF Hex Nuts			023-324	5/16	12	023-618	10 x 1/2	6
UNC Grade 5 Cap Screws			023-221	1/4	12	023-325	3/8	12	023-619	10 x 3/4	6
023-001	1/4 x 1/2	6	023-222	5/16	12	023-326	7/16	6	023-621	10 x 1	6
023-003	1/4 x 3/4	12	023-223	3/8	12	023-327	1/2	6	023-628	14 x 3/4	6
023-005	1/4 x 1	6	023-224	7/16	6	Plain Steel Washers			023-629	14 x 1	6
023-006	1/4 x 1-1/4	6	023-225	1/2	6	023-302	3/16	6	Oval Head Sheet Metal Screws		
023-007	1/4 x 1-1/2	6	023-227	5/8	6	023-303	1/4	6	023-651	10 x 1	6
023-009	1/4 x 2	6	UNC Hex Nuts			023-304	5/16	6	Hex Head Sheet Metal Screws		
023-014	5/16 x 1/2	6	023-201	1/4	12	023-305	3/8	6	023-673	14 x 3/4	6
023-016	5/16 x 3/4	12	023-202	5/16	12	023-306	7/16	6	023-677	5/16 x 1	6

023
Series

papco® HANDY-PAKS®

Papco® Handy-Paks® contain Grade 5 Medium Carbon Heat Treated Cap Screws. The higher strength and toughness of these fasteners is needed in vehicle repair work. All Handy-Paks® are bright plated for improved rust resistance and longer life.

ORDER BY STOCK NUMBER

Grade 5 Hexagon Head Cap Screws						Double Heat treated		
Coarse Thread	Fine Thread	Size	Coarse Thread	Fine Thread	Size	Coarse Thread	Fine Thread	Size
023-001	023-101	1/4 x 1/2	023-022	023-122	5/16 x 2	023-045	023-145	7/16 x 1-3/4
023-003	023-103	1/4 x 3/4	023-024	023-124	5/16 x 2-1/2	023-046	023-146	7/16 x 2
023-005	023-105	1/4 x 1	023-025	023-125	5/16 x 3	023-048	023-148	7/16 x 2-1/2
023-006	023-106	1/4 x 1-1/4	023-029	023-129	3/8 x 3/4	023-049	023-149	7/16 x 3
023-007	023-107	1/4 x 1-1/2	023-031	023-131	3/8 x 1	023-053	023-153	1/2 x 1
023-008	023-108	1/4 x 1-3/4	023-032	023-132	3/8 x 1-1/4	023-054	023-154	1/2 x 1-1/4
023-009	023-109	1/4 x 2	023-033	023-133	3/8 x 1-1/2	023-055	023-155	1/2 x 1-1/2
023-011	023-111	1/4 x 2-1/2	023-034	023-134	3/8 x 1-3/4	023-056	023-156	1/2 x 1-3/4
023-012	023-112	1/4 x 3	023-035	023-135	3/8 x 2	023-057	023-157	1/2 x 2
023-014	023-114	5/16 x 1/2	023-037	023-137	3/8 x 2-1/2	023-059	023-159	1/2 x 2-1/2
023-016	023-116	5/16 x 3/4	023-038	023-138	3/8 x 3	023-160	023-160	1/2 x 3
023-018	023-118	5/16 x 1	023-042	023-142	7/16 x 1	023-074	023-174	5/8 x 1-1/2
023-019	023-119	5/16 x 1-1/4	023-043	023-143	7/16 x 1-1/4	023-076	023-176	5/8 x 2
023-020	023-120	5/16 x 1-1/2	023-044	023-144	7/16 x 1-1/2	023-078	023-178	5/8 x 2-1/2
023-021	023-121	5/16 x 1-3/4						

ORDER BY STOCK NUMBER

Hexagon Nuts						Wing Nuts	
Finished			Pozi-Lok® Stop			UNC Coarse Thread	
Coarse Thread	Fine Thread	Size	Coarse Thread	Fine Thread	Size	Handy-Pak No.	Size
023-201	023-221	1/4	023-244	023-254	1/4	023-264	1/4-20
023-202	023-222	5/16	023-245	023-255	5/16	023-265	5/16-18
023-203	023-223	3/8	023-246	023-256	3/8	023-266	3/8-16
023-204	023-224	7/16	023-247	023-257	7/16		
023-205	023-225	1/2	023-248	023-258	1/2		
023-206	023-226	9/16					
023-207	023-227	5/8					
023-208	023-228	3/4					

ORDER BY STOCK NUMBER

Plain Steel Washers					
Handy-Pak® No.	Size	Handy-Pak® No.	Size	Handy-Pak® No.	Size
023-302	3/16	023-305	3/8	023-308	9/16
023-303	1/4	023-306	7/16	023-309	5/8
023-304	5/16	023-307	1/2	023-310	3/4
S. A. E. Washers					
023-322	3/16	023-325	3/8	023-328	9/16
023-323	1/4	023-326	7/16	023-329	5/8
023-324	5/16	023-327	1/2	023-330	3/4
Spring Lock Washers					
023-342	3/16	023-345	3/8	023-348	9/16
023-343	1/4	023-346	7/16	023-349	5/8
023-344	5/16	023-347	1/2	023-350	3/4
Countersunk Finishing Washers					
023-381	No. 6	023-385	No. 8	023-389	1/4
023-383	No. 8				
Fender Washers					
023-395	1/4 x 1-1/4 O.D.	023-397	5/16 x 1-1/4	023-398	3/8 x 1-1/2
023-396	5/16 x 1				

Note: Handy-Paks® contents are based on Dealer Prices currently in effect and are subject to change.

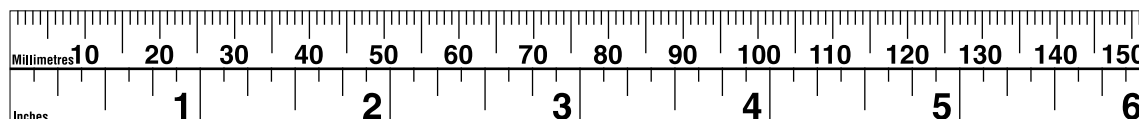

ORDER BY STOCK NUMBER

Machine Screws and Nuts								
Size	Round	Oval	Size	Round	Oval	Size	Round	Oval
6-32 x 1/2	023-403	023-433	8-32 x 1	023-412	023-422	1/4-20 x 3/4	023-424	
6-32 x 3/4	023-404	-	8-32 x 1-1/2	023-414	023-444	1/4-20 x 1	023-425	023-455
6-32 x 1	023-405	023-435	10-32 x 1/2	023-417	023-447	Hexagon Nuts		
6-32 x 1-1/4	023-406	-	10-32 x 3/4	023-418	023-448	Size	Handy-Pak No.	
6-32 x 1-1/2	023-407	-	10-32 x 1	023-419	023-449	6-32	023-460	
8-32 x 3/8	023-409	023-439	10-32 x 1-1/4	023-420	-	8-32	023-461	
8-32 x 1/2	023-410	023-440	10-32 x 1-1/2	023-421	023-451	10-32	023-462	
8-32 x 3/4	023-411	023-441	-	-	-	1/4-20	023-463	

ORDER BY STOCK NUMBER

Round Head Stove Bolts						
Size	Handy-Pak No.	Size	Handy-Pak No.	Size	Handy-Pak No.	
3/16 x 1/2	023-501	3/16 x 1-1/2	023-505	1/4 x 1		023-512
3/16 x 3/4	023-502	3/16 x 2	023-507	1/4 x 1-1/4		023-513
3/16 x 1	023-503	1/4 x 1/2	023-510	1/4 x 1-1/2		023-514
3/16 x 1-1/4	023-504	1/4 x 3/4	023-511	1/4 x 2		023-516

ORDER BY STOCK NUMBER

Sheet Metal Screws							
Size	Pan	Oval	Size	Pan	Oval	Size	Hex
4 x 1/2	023-602	-	8 x 1	023-616	023-646	8 x 1/2	023-665
6 x 3/8	023-604	-	10 x 1/2	023-618	023-648	10 x 1/2	023-667
6 x 1/2	023-605	023-635	10 x 3/4	023-619	023-649	10 x 5/8	023-668
6 x 3/4	023-607	023-637	10 x 1	023-621	023-651	10 x 3/4	023-669
6 x 1	023-609	023-639	10 x 1-1/4	023-622	023-652	14 x 1/2	023-671
8 x 3/8	023-611	-	14 x 3/4	023-628	023-658	14 x 3/4	023-673
8 x 1/2	023-612	023-642	14 x 1	023-629	023-659	14 x 1	023-675
8 x 3/4	023-614	023-644	-	-	-	5/16 x 1	023-677
-	-	-	-	-	-	3/8 x 1	023-679
Size	Oval Phillips Small		Size	Oval Phillips Small		Size	Oval Phillips Regular
8 x 1/2	023-685		8 x 1-1/2	023-692		6 x 3/4	023-696
8 x 3/4	023-687		10 x 1	023-694		8 x 3/4	023-698
8 x 1	023-689		-	-		-	-

ORDER BY STOCK NUMBER

Cotter Pins						
Size	Handy-Pak No.	Size	Handy-Pak No.	Size	Handy-Pak No.	
1/16 x 3/4	023-702	3/32 x 1	023-709	1/8 x 1-1/2		023-717
1/16 x 1	023-703	3/32 x 1-1/4	023-710	1/8 x 2		023-718
1/16 x 1-1/2	023-705	3/32 x 1-1/2	023-711	5/32 x 1-1/2		023-722
3/32 x 1/2	023-707	1/8 x 1	023-715	5/32 x 2		023-723
3/32 x 3/4	023-708	1/8 x 1-1/4	023-716			

Note: Handy-Paks[®] contents are based on Dealer Prices currently in effect and are subject to change.

INVERTED DRAWER BOX
BOÎTE DE TIROIR INVERSÉE

Inverted Drawer Box

- Upside-down design converts to double strength drawer.
- Drawer pull for easy access.
- Heavy weight fibreboard.



Convenient Six-Pak trays

METRIC HANDY-PAKS[®]
HANDY-PAKS[®] MÉTRIQUE

No. 022-068

Contains 273 Handy-Paks[®], 91 sizes of ISO Coarse, Fine and Extra Fine Cap Screws, Nuts and Washers plus rack, measuring gauge and sign.

UNIFORM PRICED PACKAGES OF METRIC FASTENERS

- All bright plated material.
- No broken boxes.
- Good for regular stock.
- Ideal for assortment refills.
- Best value.
- Fully illustrated, colour-coded labels.
- Sturdy, heavy gauge, reinforced steel cabinet.
- Use on work bench or hang on wall.
- Colourful - Durable - Efficient.
- Includes handy bolt measuring gauge and inventory control strips.

Papco[®] Handy-Paks[®] are the most economical method of stocking Metric Fasteners. They contain the complete range of ISO Coarse, Fine and Extra Fine Cap Screws and Nuts as well as Washers. The available merchandiser is designed to provide maximum coverage for a minimum investment.



022-068 71"H x 36-1/4"W x 12"D including sign

No. 022-068

MERCHANDISER CONTENTS

Stock No.	Size	Stock No.	Size	Stock No.	Size	Stock No.	Size
ISO Coarse Metric Cap Screws		ISO Coarse Metric Cap Screws		Fine Metric Cap Screws		Extra Fine Metric Hex Nuts	
024-002	M4 x 16	024-060	M10 x 20	024-144	M12 x 30	024-270	M10 x 1.00
024-004	M4 x 25	024-061	M10 x 25	024-146	M12 x 40	024-272	M12 x 1.25
024-012	M5 x 12	024-062	M10 x 30	024-148	M12 x 50	Metric Flat Washers	
024-013	M5 x 16	024-063	M10 x 35	Extra Fine Metric Cap Screws		024-304	4 mm
024-014	M5 x 20	024-064	M10 x 40	024-170	M10 x 20	024-305	5 mm
024-015	M5 x 25	024-066	M10 x 50	024-171	M10 x 25	024-306	6 mm
024-023	M6 x 12	024-068	M10 x 60	024-172	M10 x 30	024-308	8 mm
024-024	M6 x 16	024-070	M10 x 70	024-174	M10 x 40	024-310	10 mm
024-025	M6 x 20	024-075	M12 x 30	024-176	M10 x 50	024-312	12 mm
024-026	M6 x 25	024-077	M12 x 40	024-184	M12 x 30	Metric Lock Washers	
024-027	M6 x 30	024-079	M12 x 50	024-186	M12 x 40	024-324	4 mm
024-028	M6 x 35	024-081	M12 x 60	024-188	M12 x 50	024-325	5 mm
024-029	M6 x 40	024-083	M12 x 70	ISO Coarse Metric Hex Nuts		024-326	6 mm
024-030	M6 x 45	Fine Metric Cap Screws		024-204	M4	024-328	8 mm
024-031	M6 x 50	024-120	M8 x 20	024-205	M5	024-330	10 mm
024-045	M8 x 12	024-122	M8 x 30	024-206	M6	024-332	12 mm
024-046	M8 x 16	024-124	M8 x 40	024-208	M8	Metric Lock Nuts	
024-047	M8 x 20	024-126	M8 x 50	024-210	M10	024-224	M4
024-048	M8 x 25	024-130	M10 x 20	024-212	M12	024-226	M6
024-049	M8 x 30	024-131	M10 x 25	Fine Metric Hex Nuts		024-228	M8
024-050	M8 x 35	024-132	M10 x 30	024-258	M8 x 1.00	024-230	M10
024-051	M8 x 40	024-133	M10 x 35	024-260	M10 x 1.25	Metric Machine Screws	
024-052	M8 x 45	024-134	M10 x 40	024-262	M12 x 1.5	024-430	M6 x 10
024-053	M8 x 50	024-136	M10 x 50			024-436	M6 x 16
024-055	M8 x 60	024-138	M10 x 60			024-440	M6 x 20
024-057	M8 x 70						

Note: Metric Handy-Paks[®] contents are based on Dealer prices currently in effect and are subject to change.

METRIC HANDY-PAKS® HANDY-PAKS® MÉTRIQUE

CLASS 8.8 COARSE HEX HEAD CAP SCREWS					
Handy-Pak® No.	Size	Handy-Pak® No.	Size	Handy-Pak® No.	Size
024-002	M4 x 16*	024-031	M6 x 50	024-062	M10 x 30*
024-004	M4 x 25	024-045	M8 x 12*	024-063	M10 x 35*
024-012	M5 x 12*	024-046	M8 x 16*	024-064	M10 x 40
024-013	M5 x 16*	024-047	M8 x 20*	024-066	M10 x 50
024-014	M5 x 20*	024-048	M8 x 25*	024-068	M10 x 60
024-015	M5 x 25*	024-049	M8 x 30*	024-070	M10 x 70
024-023	M6 x 12*	024-050	M8 x 35	024-075	M12 x 30*
024-024	M6 x 16*	024-051	M8 x 40	024-077	M12 x 40*
024-025	M6 x 20*	024-052	M8 x 45	024-079	M12 x 50
024-026	M6 x 25*	024-053	M8 x 50	024-081	M12 x 60
024-027	M6 x 30	024-055	M8 x 60	024-083	M12 x 70
024-028	M6 x 35	024-057	M8 x 70		
024-029	M6 x 40	024-060	M10 x 20*		
024-030	M6 x 45	024-061	M10 x 25*		

Thread Length:
Formula is 2D + 6 mm.
Items marked * are fully threaded.

CLASS 8.8 FINE THREAD HEX HEAD CAP SCREWS			
Handy-Pak® No.	Size	Handy-Pak® No.	Size
024-120	M8 x 1.0 x 20*	024-133	M10 x 1.25 x 35*
024-122	M8 x 1.0 x 30*	024-134	M10 x 1.25 x 40*
024-124	M8 x 1.0 x 40*	024-136	M10 x 1.25 x 50*
024-126	M8 x 1.0 x 50*	024-138	M10 x 1.25 x 60
024-130	M10 x 1.25 x 20*	024-144	M12 x 1.5 x 30*
024-131	M10 x 1.25 x 25*	024-146	M12 x 1.5 x 40*
024-132	M10 x 1.25 x 30*	024-148	M12 x 1.5 x 50*

CLASS 8.8 EXTRA FINE THREAD HEX HEAD CAP SCREWS			
Handy-Pak® No.	Size	Handy-Pak® No.	Size
024-170	M10 x 1.0 x 20*	024-176	M10 x 1.0 x 50*
024-171	M10 x 1.0 x 25*	024-184	M12 x 1.25 x 30*
024-172	M10 x 1.0 x 30*	024-186	M12 x 1.25 x 40*
024-174	M10 x 1.0 x 40*	024-188	M12 x 1.25 x 50*

CLASS 8 COARSE HEX NUTS					
Handy-Pak® No.	Size	Handy-Pak® No.	Size	Handy-Pak® No.	Size
024-204	M4	024-206	M6	024-210	M10
024-205	M5	024-208	M8	024-212	M12

NYLON COLLAR STOP NUTS 'POZI-LOK®' NUTS					
Handy-Pak® No.	Size	Handy-Pak® No.	Size	Handy-Pak® No.	Size
024-224	M4	024-226	M6	024-230	M10
024-225	M5	024-228	M8		

CLASS 8 FINE AND EXTRA FINE THREAD HEX NUTS			
Handy-Pak® No.	Size	Handy-Pak® No.	Size
024-258	M8 x 1.0	024-270	M10 x 1.0
024-260	M10 x 1.25	024-272	M12 x 1.25
024-262	M12 x 1.5		

FLAT WASHERS					
Handy-Pak® No.	Size	Handy-Pak® No.	Size	Handy-Pak® No.	Size
024-304	4 mm	024-306	6 mm	024-310	10 mm
024-305	5 mm	024-308	8 mm	024-312	12 mm

LOCK WASHERS					
Handy-Pak® No.	Size	Handy-Pak® No.	Size	Handy-Pak® No.	Size
024-324	4 mm	024-326	6 mm	024-330	10 mm
024-325	5 mm	024-328	8 mm	024-332	12 mm

SPRING (WAVE TYPE) WASHERS (PLAIN FINISH)			
Handy-Pak® No.	Size	Handy-Pak® No.	Size
024-344	4 mm	024-348	8 mm
024-345	5 mm	024-350	10 mm
024-346	6 mm		

MACHINE SCREWS PAN PHILLIPS HEAD			
Handy-Pak® No.	Size	Handy-Pak® No.	Size
024-398	M3-0.5 x 6	024-421	M5-0.8 x 12
024-399	M3-0.5 x 10	024-422	M5-0.8 x 20
024-400	M3-0.5 x 16	024-423	M5-0.8 x 25
024-401	M3-0.5 x 20	024-424	M5-0.8 x 30
024-402	M3-0.5 x 25	024-425	M5-0.8 x 35
024-403	M3-0.5 x 30	024-426	M5-0.8 x 16
024-404	M3-0.5 x 35	024-427	M5-0.8 x 40
024-405	M3-0.5 x 50	024-428	M5-0.8 x 50
024-406	M4-0.7 x 6	024-429	M6-1.0 x 8
024-407	M4-0.7 x 10	024-430	M6-1.0 x 10
024-410	M4-0.7 x 16	024-432	M6-1.0 x 12
024-411	M4-0.7 x 20	024-436	M6-1.0 x 16
024-412	M4-0.7 x 12	024-440	M6-1.0 x 20
024-413	M4-0.7 x 25	024-441	M6-1.0 x 25
024-414	M4-0.7 x 30	024-442	M6-1.0 x 30
024-415	M4-0.7 x 35	024-443	M6-1.0 x 35
024-416	M4-0.7 x 40	024-444	M6-1.0 x 40
024-417	M4-0.7 x 50	024-446	M6-1.0 x 50
024-418	M4-0.7 x 60	024-448	M8-1.25 x 12
024-419	M5-0.8 x 6	024-451	M8-1.25 x 30
024-420	M5-0.8 x 10	024-453	M8-1.25 x 40

COTTER PINS			
Handy-Pak® No.	Size	Handy-Pak® No.	Size
024-704	M1.5 x 16	024-713	M3 x 40
024-707	M2.0 x 20	024-716	M4 x 50
024-710	M3 x 25		

SLOTTED SPRING PINS (PLAIN FINISH)			
Handy-Pak® No.	Size	Handy-Pak® No.	Size
024-734	M2.0 x 16	024-752	M4 x 50
024-737	M2.5 x 18	024-755	M5 x 36
024-740	M3.0 x 24	024-758	M5 x 50
024-743	M3.0 x 40	024-761	M6 x 22
024-746	M4 x 18	024-764	M6 x 50
024-749	M4 x 36		

MACHINE SCREWS PAN SLOT HEAD					
Handy-Pak® No.	Size	Handy-Pak® No.	Size	Handy-Pak® No.	Size
024-406	M4 x 6	024-420	M5 x 10	024-430	M6 x 10
024-412	M4 x 12	024-426	M5 x 16	024-436	M6 x 16
				024-440	M6 x 20

SOCKET SCREWS KEYS (PLAIN FINISH)					
Handy-Pak® No.	Size	Handy-Pak® No.	Size	Handy-Pak® No.	Size
024-904	M4 x 5	024-916	M6 x 8	024-926	M8 x 8
024-907	M4 x 10	024-919	M6 x 12	024-930	M8 x 12
024-910	M5 x 10	024-922	M6 x 20	024-934	M8 x 20
024-913	M5 x 16				

SOCKET SCREWS KEYS (PLAIN FINISH)					
Handy-Pak® No.	Size	Handy-Pak® No.	Size	Handy-Pak® No.	Size
024-980	1.5 mm	024-983	3 mm	024-986	6 mm
024-981	2.0 mm	024-984	4 mm	024-988	8 mm
024-982	2.5 mm	024-985	5 mm		

More pieces per pack than Handy-Paks[®]!

Papco[®] Mega-Paks[®] are uniformly priced packages of the most popular high-strength Grade 8 fasteners in both UNC Coarse and UNF Fine Thread, Stainless Steel plus Marine Fasteners. Each Mega-Pak[®] features a larger quantity than standard Handy-Paks[®], illustrated colour-coded labels and a double strength drawer box conveniently packed in Six-Pak trays.

Papco[®] Mega-Paks[®] are available individually or in factory prepared Merchandisers containing 35 sizes of the fastest moving sizes of High-Strength Grade 8 Fasteners and Marine Fasteners.

- Sturdy, heavy gauge, reinforced steel cabinet.
- Use on work bench or hang on wall.
- Colourful - Durable - Efficient.
- Includes handy bolt measuring gauge.
- 18-1/2" W x 14-3/4" H.



025-057



18-1/2" W x 14-3/4" H

No. 022-059 UNF PLATED GRADE 8 FASTENER MERCHANDISER

ORDER BY STOCK NO.

Stock No.	Size	Stock No.	Size	Stock No.	Size	Stock No.	Size	Stock No.	Size
UNF Plated Grade 8 Cap Screws		UNF Plated Grade 8 Cap Screws		UNF Grade 8 Hex Nuts		Grade 8 Tension Washers		Grade 8 Lock Washers	
025-103	1/4-28 x 3/4	025-142	7/16-20 x 1	025-221	1/4-28	025-303	1/4	025-343	1/4
025-105	1/4-28 x 1	025-144	7/16-20 x 1-1/2	025-222	5/16-24	025-304	5/16	025-344	5/16
025-107	1/4-28 x 1-1/2	025-155	1/2-20 x 1-1/2	025-223	3/8-24	025-305	3/8	025-345	3/8
025-116	5/16-24 x 3/4	025-157	1/2-20 x 2	025-224	7/16-20	025-306	7/16	025-346	7/16
025-118	5/16-24 x 1	025-159	1/2-20 x 2-1/2	025-225	1/2-20	025-307	1/2	025-347	1/2
025-120	5/16-24 x 1-1/2	025-174	5/8-18 x 1-1/2	025-227	5/8-18	025-309	5/8	025-349	5/8
025-131	3/8-24 x 1	025-176	5/8-18 x 2						
025-133	3/8-24 x 1-1/2	025-178	5/8-18 x 2-1/2						
025-135	3/8-24 x 2								

No. 022-060 UNC PLATED GRADE 8 FASTENER MERCHANDISER

ORDER BY STOCK NO.

Stock No.	Size	Stock No.	Size	Stock No.	Size	Stock No.	Size	Stock No.	Size
UNC Plated Grade 8 Cap Screws		UNC Plated Grade 8 Cap Screws		UNC Grade 8 Hex Nuts		Grade 8 Tension Washers		Grade 8 Lock Washers	
025-003	1/4-20 x 3/4	025-042	7/16-14 x 1	025-201	1/4-20	025-303	1/4	025-343	1/4
025-005	1/4-20 x 1	025-044	7/16-14 x 1-1/2	025-202	5/16-18	025-304	5/16	025-344	5/16
025-007	1/4-20 x 1/2	025-055	1/2-13 x 1-1/2	025-203	3/8-16	025-305	3/8	025-345	3/8
025-016	5/16-18 x 3/4	025-057	1/2-13 x 2	025-204	7/16-14	025-306	7/16	025-346	7/16
025-018	5/16-18 x 1	025-059	1/2-13 x 2-1/2	025-205	1/2-13	025-307	1/2	025-347	1/2
025-020	5/16-18 x 1-1/2	025-074	5/8-11 x 1-1/2	025-207	5/8-11	025-309	5/8	025-349	5/8
025-031	3/8-16 x 1	025-076	5/8-11 x 2						
025-033	3/8-16 x 1-1/2	025-078	5/8-11 x 2-1/2						
025-035	3/8-16 x 2								

No. 022-057 UNC 18.8 STAINLESS STEEL BOLT AND NUT MERCHANDISER

ORDER BY STOCK NO.

Stock No.	Size	Stock No.	Size	Stock No.	Size	Stock No.	Size	Stock No.	Size
UNC 18.8 S.S. Steel Cap Screws		UNC 18.8 S.S. Steel Cap Screws		UNC 18.8 S.S. Steel Cap Screws		UNC 18.8 Stainless Steel Pozi-Lok[®] Nuts		18.8 Stainless Steel Fender Washers	
025-401	1/4 x 1/2	025-418	5/16 x 1	025-437	3/8 x 2-1/2	025-511	1/4	025-531	1/4
025-403	1/4 x 3/4	025-420	5/16 x 1-1/2	025-438	3/8 x 3	025-512	5/16	025-532	5/16
025-405	1/4 x 1	025-422	5/16 x 2	025-439	3/8 x 3-1/2	025-513	3/8	025-533	3/8
025-407	1/4 x 1-1/2	025-424	5/16 x 2-1/2	UNC 18.8 S.S. Steel Hex Nuts		18.8 Stainless Steel Flat Washers		18.8 Stainless Steel Cotter Pins	
025-409	1/4 x 2	025-429	3/8 x 3/4	025-501	3/8 x 1	025-521	1/4	025-541	3/32 x 1-1/2
025-411	1/4 x 2-1/2	025-431	3/8 x 1	025-502	5/16	025-522	5/16	025-542	3/32 x 2
025-414	5/16 x 1/2	025-433	3/8 x 1-1/2	025-503	3/8	025-523	3/8	025-548	1/8 x 2
025-416	5/16 x 3/4	025-435	3/8 x 2					025-551	1/8 x 3

No. 022-058 18.8 STAINLESS STEEL SCREW MERCHANDISER

ORDER BY STOCK NO.

Stock No.	Size	Stock No.	Size	Stock No.	Size	Stock No.	Size	Stock No.	Size
18.8 Stainless Steel Round Slot Machine Screws		18.8 Stainless Steel Oval Phillips Machine Screws		18.8 Stainless Steel Flat Socket Tapping Screws		8.8 Stainless Steel Flat Socket Tapping Screws		18.8 Stainless Steel Hex Machine Screw Nuts	
025-613	10-24 x 1	025-620	10-24 x 1	025-651	6 x 3/4	025-660	12 x 1-1/2	025-700	10-24
025-614	10-24 x 1-1/2	025-621	10-24 x 1-1/4	025-652	6 x 1	025-661	12 x 2	025-701	1/4
025-615	10-24 x 2	025-622	10-24 x 1-1/2	025-653	8 x 3/4	025-662	12 x 2-1/2		
025-616	1/4 x 1	025-623	1/4 x 1	025-654	8 x 1	18.8 Stainless Steel Pan Socket Tapping Screws		18.8 Stainless Steel Finishing Washers	
025-617	1/4 x 11/2	025-624	1/4 x 11/2	025-655	8 x 1-1/4	025-674	8 x 1	025-706	No. 6
025-618	1/4 x 2	025-625	1/4 x 2	025-656	8 x 1-1/2	025-676	8 x 1-1/2	025-708	No. 8
025-619	1/4 x 21/2			025-657	10 x 1-1/4	025-678	10 x 1-1/2	025-709	No. 10
				025-658	10 x 1-1/2	025-679	10 x 2	025-710	1/4
				025-659	10 x 2				

For Wheel Parts Mega-Pak[®] Merchandiser No. 022-056 see Wheel Parts page 186 or current Wheel parts catalogue.

**AUTOMOTIVE FASTENER MERCHANDISER
PRÉSENTOIR DE FIXATIONS AUTOMOBILES**

No. 022-148A

(FOR PEGBOARD DISPLAY, WITHOUT SPINNER)



No. 022-148



Signage & hooks included - gondolas NOT included



Signage, hooks & spinner included

LIST OF CONTENTS AVAILABLE UPON REQUEST

LIST OF CONTENTS

- **Metric 8.8**
 - Cap Screws Coarse, Fine & Extra Fine
- **Metric 8.0**
 - Nuts Coarse, Fine & Extra Fine
- **Metric 10.9**
 - Cap Screws Bare
 - Nuts Bare
- **Metric**
 - Flat Washers Plated
 - Lock Washers Plated
- **Licence Plate Hardware**
- **Metal Screw**
 - Drill-X[®] Hex Washer Head Metal Screw Plated
 - Indented Hex Washer Head Type A
- **JIS Metric Flange Bolt**
- **Metric/Imperial Studs**

- **Imperial**
 - Cap Screws Gr. 8
 - Nuts Gr. 8
 - Conelok[®] Nuts Gr. C
 - Papocolloy Flat Washers
 - Lock Washers
- **Stainless Steel 18.8**
 - Cap Screws
 - Nuts
 - Clevis Pins
 - Blind Rivets
 - Lock Washers
 - Flat Washers
 - Machine Screws
 - Wing Nuts
 - Finishing Washers
 - Tapping Screws
 - Back-up Plate

- **Rivets & Pins**
 - Blind Rivets
 - Cotter Pins
 - Universal Clevis Pins
- **Fluid Flow**
 - Grease Fittings
 - Push On Hose (End Mender)
 - Drain Cock
 - Flare Nut/Union Adapter
 - Garden Hose
 - Pipe Elbow
 - Pipe Tee
 - Pipe Coupling
 - Pipe Bushing
 - Pipe Nipple
 - Pipe Plug

**BODY SHOP MERCHANDISER
PRÉSENTOIR DE CARROSSERIE**

No. 022-158A

(FOR PEGBOARD DISPLAY, WITHOUT SPINNER)



Signage & hooks included - gondolas NOT included



No. 022-158

Signage, hooks & spinner included

PLEASE REFER TO CURRENT BODY SHOP FASTENERS CATALOGUE FOR CONTENT LISTING

LIST OF CONTENTS

- **Plastic Plug Buttons**
- **'U' Nuts:** Nylon 'U' Nuts, Single Thread 'U' Nuts, Speed Nuts
- **Grommets:** Headlamp Bezels, Licence Plate Nuts, Grille Fasteners, Headlamp Door Nut
- **Windshield Mouldings:** Hog Ring, Glass Shop Fasteners
- **Bumper Bolts**
- **Washers & Shims:** Machine Screw Nuts, Fender Washers, Body Shims
- **Multi-Thread 'U' Nuts**
- **Plastic Retainers:** 'Push' Type, Trim Fasteners, Plastic Shield, Screw In, Weather Strip Fasteners, Cable Straps
- **Body Bolts:** Metal Screws, Clevis Pins, Licence Plate Bolts, Metric Flange Nuts
- **Self-Threading Palnuts**
- **Rivets:** Blind Rivets, Regulator Rivets, Plastic Rivets
- **Tubular Type Speed Clips**
- **Hinge Pins & Bushings**
- **Mounting Nuts:** 'Jack' Nuts, Blind Well Nuts
- **Moulding Fasteners**
- **Pushnuts Bolt Retainers**
- **Metal Screws:** Trim Screws

**THREAD DETECTIVE[®]
IMPERIAL/METRIC • IMPÉRIAL/MÉTRIQUE**

No. 022-185

- This Thread Detective is an easy and precise thread identifier for both nuts and bolts, consisting of gliding gauges conveniently assembled onto a wire lanyard.
- It is well suited for distinguishing between similar inch and metric threads.
- Thread sizes are stamped onto each gauge and are coated with a PVC shrink tubing ensuring numbers will never rub off.
- Thread Detective[®] is equipped with a 3-3/8" (85mm) ruler for measuring stud lengths.
- It has a convenient extra long rope for those hard to reach places, as well as loops on each end for hanging.

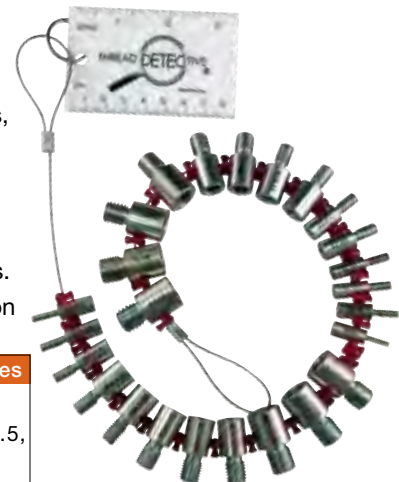

Inch identifiers consist of nut and bolt sizes

6-32, 8-32, 10-24, 10-32, 1/4-20, 1/4-28, 5/16-18, 5/16-24, 3/8-16, 3/8-24, 7/16-14, 7/16-20, 1/2-13 and 1/2-20.

Metric identifiers consist of nut and bolt sizes

M4 x 0.7, M5 x 0.8, M6 x 1.0, M8 x 1.0, M8 x 1.25, M10 x 1.0, M10 x 1.25, M10 x 1.5, M12 x 1.25, M12 x 1.5 and M12 x 1.75.

METRIC FASTENERS

ATTACHES MÉTRIQUE

METRIC HEX HEAD SCREW
SOCKET HEX CAP SCREW
FLAT SOCKET CAP SCREW
BUTTON HEAD CAP SCREW
SOCKET SET SCREW
CLAMSHELL PACKS

NUTS
- 'CONELOK'
- HEX
- POZI-LOK
- TRI-LOK

WASHERS
FLANGE BOLTS
BODY SHOP FASTENERS
BUMPER BAR BOLTS
FLANGE NUTS
SCREWS
- LICENCE PLATE
- MACHINE
- TAPPING & TRIM
'U' NUTS

BOLT RETAINERS
BODY BOLTS
RODS
STUDS
COTTER PINS
18.8 STAINLESS STEEL
- HEX HEAD CAP SCREWS
- HEX NUTS
- SCREWS
- SOCKET HEAD CAP SCREWS
- WASHERS



8.8 METRIC HEX HEAD CAP SCREWS BOULONS DE PRÉCISION MÉTRIQUE 8,8

608 Series

- High tensile screws made to ISO-Metric specifications
- Property Class: 8.8 (nominal tensile strength 800 MPa or about 118,000 p.s.i., similar to S.A.E. Grade 5)
- Heat Treated Steel, Zinc Chromate plated
- Regular ISO Coarse Thread Series

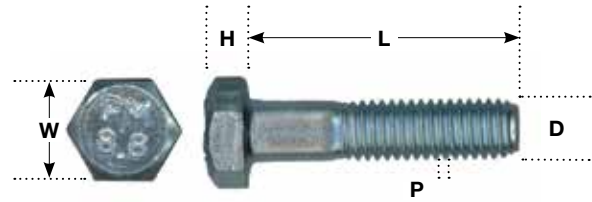

For **SUPER-SERVICE ASSORTMENT**
No. **020-842** of Metric Fasteners
please refer to page **10**.

ORDER BY STOCK NUMBER

Dia. (D)	M4	M5	M6	M8	M10	M12	M14	M16	M18	M20	M24
Inch Size	.157	.197	.236	.315	.394	.472	.551	.630	.709	.787	.944
A.F. (W)	7	8	10	13	17	19	22	24	27	30	36
Height. (H)	2.8	3.5	4.0	5.5	7.0	8.0	9.0	10.0	12.0	13.0	15.0
Pitch (mm)	.70	.80	1.00	1.25	1.50	1.75	2.00	2.00	2.50	2.50	3.00
Length											
12 mm	-	608-198*	608-267*◇	608-311*	-	-	-	-	-	-	-
16 mm	608-139*	608-201*	608-270*◇	608-314*◇	608-364*	-	-	-	-	-	-
20 mm	608-141*	608-203*	608-272*◇	608-316*◇	608-366*◇	-	-	-	-	-	-
25 mm	608-143*	608-205*	608-274*◇	608-318*◇	608-368*◇	608-412*◇	608-436*	608-462*	-	-	-
30 mm	-	-	608-276 ◇	608-320*◇	608-370*	608-414*	608-438*	608-464*	-	-	-
35 mm	-	-	608-277 ◇	608-321 ◇	608-371*◇	608-415*◇	-	608-465*	-	-	-
40 mm	-	-	608-278 ◇	608-322 ◇	608-372 ◇	608-416*◇	608-440*	608-466*	608-500*	608-520*	-
45 mm	-	-	608-279	608-323 ◇	608-373	608-417	-	608-467*	-	-	-
50 mm	-	-	608-280	608-324 ◇	608-374 ◇	608-418 ◇	608-442	608-468*	608-502*	608-522*	608-552*
60 mm	-	-	608-283	608-326	608-376 ◇	608-420 ◇	608-444	608-470	608-504	608-524*	608-554*
70 mm	-	-	608-285	608-328	608-378 ◇	608-422 ◇	608-446	608-472	608-506	608-526	608-556*
80 mm	-	-	608-287	608-330	608-380	608-424	608-448	608-474	608-508	608-528	608-558
90 mm	-	-	-	-	-	608-425	608-449	608-475	608-509	608-529	608-559
100 mm	-	-	-	-	608-382	608-426	608-450	608-476	608-510	608-530	608-560
110 mm	-	-	-	-	-	608-427	608-451	608-477	608-511	608-531	608-561
120 mm	-	-	-	-	-	608-428	608-452	608-478	608-512	608-532	608-562
130 mm	-	-	-	-	-	608-429	-	608-479	608-513	608-533	608-563
140 mm	-	-	-	-	-	608-430	-	608-480	608-514	608-534	608-564
150 mm	-	-	-	-	-	608-431	-	608-481	608-515	608-535	608-565
160 mm	-	-	-	-	-	608-432	-	608-482	-	608-536	608-566
170 mm	-	-	-	-	-	608-433	-	-	-	608-537	-
180 mm	-	-	-	-	-	608-434	-	-	-	608-538	608-568
190 mm	-	-	-	-	-	-	-	-	-	608-539	-
200 mm	-	-	-	-	-	608-435	-	-	-	608-540	-

◇ This item is also available in clamshell clear pack. See page 34.

* Indicates items fully threaded. Thread Length Formula is $2d+6$ mm.

Standard packages: M4 to M10 - 100 pcs, M12 - 50 pcs, M14 to M24 x 80 - 25 pcs, M24 x 90 to 180 mm - 10 pcs.

8.8 METRIC HEX HEAD CAP SCREWS - FINE AND EXTRA FINE THREAD BOULONS DE PRÉCISION MÉTRIQUE 8,8 - FIL FIN ET PLUS FIN

609 Series

610 Series

- High tensile screws made to ISO-Metric specifications
- Property Class: 8.8 (normal tensile strength 800 MPa or about 118,000 p.s.i., similar to S.A.E. Grade 5)
- Heat Treated Steel, Dichromate plated



ORDER BY STOCK NUMBER

Dia. x Pitch	M8 x 1.0	M10 x 1.25	M12 x 1.5	M14 x 1.5	M16 x 1.5	M18 x 1.5	M20 x 1.5	M10 x 1.0	M12 x 1.25
Length	Fine Thread							X-Fine Thread	
20 mm	609-316*	609-366*	-	-	-	-	-	610-366*	-
25 mm	-	609-368*	-	609-436*	-	-	-	610-368*	-
30 mm	609-320*	609-370*◇	609-414*◇	609-438*	609-464*	-	-	610-370*	610-414*◇
40 mm	609-322	609-372 ◇	609-416*◇	609-440*	609-466*	609-500*	609-520*	610-372*	610-416*◇
45 mm	-	-	609-417*	609-441*	-	-	-	-	-
50 mm	609-324	609-374*◇	609-418 ◇	609-442	609-468*	609-502*	609-522*	610-374*	610-418*◇
55 mm	-	-	609-419	-	-	-	-	-	-
60 mm	-	609-376	609-420	609-444	609-470	609-504	609-524*	-	-
65 mm	-	-	609-421	-	-	-	-	-	-
70 mm	-	609-378	609-422	609-446	609-472	609-506	609-526	-	-
80 mm	-	609-380	609-424	609-448	609-474	609-508	609-528	-	-
90 mm	-	609-382	609-425	-	609-475	609-509	609-529	-	-
100 mm	-	609-384	609-426	-	609-476	-	609-530	-	-
110 mm	-	-	-	-	609-477	-	609-532	-	-

◇ This item is also available in clamshell clear pack. See page 34.

* Indicates items fully threaded. Thread Length Formula is $2d+6$ mm.

Standard packages: Fine Thread M8 to M10 x 60 - 50 pcs, M10 x 70 to M18 x 90 - 25 pcs, M20 - 10 pcs. Extra Fine Thread - 25 pcs.

10.9 METRIC HEX HEAD CAP SCREWS BOULONS DE PRÉCISION MÉTRIQUE 10,9

613
Plated

- High Tensile Screws made to ISO-Metric Specifications
- Property Class: Grade 10.9 (minimum tensile strength 1040 MPa or about 150,000 p.s.i., similar to SAE Grade 8)
- Heat Treated Steel, Yellow Zinc Dichromate plated
- Regular ISO Coarse Thread Series

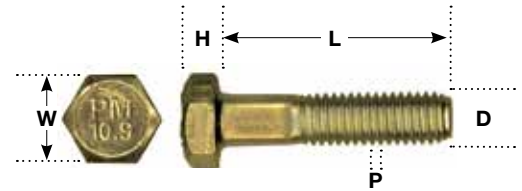

ORDER BY STOCK NUMBER

Dia.(D)	M4	M5	M6	M8	M10	M12	M14	M16	M18	M20	M24
Inch Size	.157	.197	.236	.315	.394	.472	.551	.630	.709	.787	.944
A.F. (W)	7	8	10	13	17	19	22	24	27	30	36
Height. (H)	2.8	3.5	4.0	5.5	7.0	8.0	9.0	10.0	12.0	13.0	15.0
Pitch (mm)	.70	.80	1.00	1.25	1.50	1.75	2.00	2.00	2.50	2.50	3.00
Length											
12 mm	-	613-198*	613-267*	613-311*	-	-	-	-	-	-	-
16 mm	613-139*	613-201*	613-270*	613-314*	613-364*	-	-	-	-	-	-
20 mm	613-141*	613-203*	613-272*◇	613-316*◇	613-366*◇	-	-	-	-	-	-
25 mm	613-143*	613-205*	613-274*◇	613-318*◇	613-368*◇	613-412*	613-436*	613-462*	-	-	-
30 mm	-	-	613-276 ◇	613-320*◇	613-370*	613-414*	613-438*	613-464*	-	-	-
35 mm	-	-	613-277 ◇	613-321 ◇	613-371*◇	613-415*◇	-	613-465*	-	-	-
40 mm	-	-	613-278 ◇	613-322 ◇	613-372 ◇	613-416*◇	613-440*	613-466*	613-500*	613-520*	-
45 mm	-	-	613-279	613-323 ◇	613-373	613-417	-	613-467*	-	-	-
50 mm	-	-	613-280	613-324 ◇	613-374 ◇	613-418 ◇	613-442	613-468*	613-502*	613-522*	613-552*
60 mm	-	-	613-283	613-326	613-376 ◇	613-420 ◇	613-444	613-470	613-504	613-524*	613-554*
70 mm	-	-	613-285	613-328	613-378 ◇	613-422 ◇	613-446	613-472	613-506	613-526	613-556*
80 mm	-	-	613-287	613-330	613-380	613-424	613-448	613-474	613-508	613-528	613-558
90 mm	-	-	-	-	-	613-425	613-449	613-475	613-509	613-529	613-559
100 mm	-	-	-	-	613-382	613-426	613-450	613-476	613-510	613-530	613-560
110 mm	-	-	-	-	-	613-427	613-451	613-477	613-511	613-531	613-561
120 mm	-	-	-	-	-	613-428	613-452	613-478	613-512	613-532	613-562
130 mm	-	-	-	-	-	613-429	-	613-479	613-513	613-533	613-563
140 mm	-	-	-	-	-	613-430	-	613-480	613-514	613-534	613-564
150 mm	-	-	-	-	-	613-431	-	613-481	613-515	613-535	613-565
160 mm	-	-	-	-	-	613-432	-	613-482	-	613-536	613-566
170 mm	-	-	-	-	-	613-433	-	-	-	613-537	-
180 mm	-	-	-	-	-	613-434	-	-	-	613-538	613-568
200 mm	-	-	-	-	-	613-435	-	-	-	613-540	-

◇ This item is also available in clamshell clear pack. See page 34.
* Indicates items fully threaded. Thread Length Formula is 2d+6 mm.

Standard packages: M4 to M10 - 100 pcs, M12 - 50 pcs, M14 to M24 x 80 - 25 pcs, M24 x 90 to 180 mm - 10 pcs.

615
Series



CLASS 8.8 YELLOW ZINC HEX CAP W/ CAPTIVE WASHER			
Part No.	Dia. x Length	Pkg Qty	A/F
615-460	M5 - 0.8 x 25	40	8
615-462	M5 - 0.8 x 30	40	8
615-466	M5 - 0.8 x 40	40	8
615-512	M6 - 1.0 x 30	20	10
615-514	M6 - 1.0 x 35	20	10
615-518	M6 - 1.2 x 45	20	10
615-520	M6 - 1.0 x 50	20	10
615-568	M8 - 1.25 x 45	15	13
615-570	M8 - 1.25 x 50	15	13
615-574	M8 - 1.25 x 60	15	13
615-605	M10 - 1.25 x 16	15	15
615-610	M10 - 1.25 x 25	15	15
615-636	M10 - 1.25 x 100	10	15

622
Series



CLASS 12.9 SOCKET HEX CAP SCREW			
Part No.	Dia. x Length	Pkg Qty	Hex Size
622-126	M3 - .50 x 12	100	2.5
622-136	M4 - .70 x 12	100	3
622-198	M5 - .80 x 12	100	4
622-205	M5 - .80 x 25	100	4
622-266	M6 - 1.0 x 10	100	5
622-274	M6 - 1.0 x 25	100	5
622-279	M6 - 1.0 x 45	100	5
622-318	M8 - 1.25 x 25	100	6
622-320	M8 - 1.25 x 30	100	6
622-324	M8 - 1.25 x 50	100	6
622-366	M10 - 1.5 x 20	100	8
622-371	M10 - 1.5 x 35	100	8
622-376	M10 - 1.5 x 60	50	8
622-410	M12 - 1.75 x 20	50	10
622-417	M12 - 1.75 x 45	50	10
622-436	M14 - 2.0 x 25	25	12
622-442	M14 - 2.0 x 50	25	12
622-465	M16 - 2.0 x 35	25	14
622-520	M20 - 2.5 x 40	15	17
622-554	M24 - 2.5 x 60	5	19

623
Series



CLASS 12.9 FLAT SOCKET CAP SCREW			
Part No.	Dia. x Length	Pkg Qty	Hex Size
623-141	M4 - .70 x 20	100	2.5
623-205	M5 - .80 x 25	100	3
623-267	M6 - 1.0 x 12	100	4
623-277	M6 - 1.0 x 35	100	4
623-318	M8 - 1.25 x 25	100	5
623-373	M10 - 1.5 x 45	100	6
623-415	M12 - 1.75 x 35	50	8
623-464	M16 - 2.0 x 30	25	10

624
Series



BUTTON HEAD CAP SCREW			
Part No.	Dia. x Length	Pkg Qty	Hex Size
624-368	M10 - 1.5 x 25	100	6
624-370	M10 - 1.5 x 30	100	6
624-374	M10 - 1.5 x 50	100	6
624-375	M10 - 1.5 x 55	100	6

SOCKET SET SCREW			
Part No.	Dia. x Length	Pkg Qty	Hex Size
623-108	M2 - .40 x 8	100	0.9
623-116	M2.5 - .45 x 12	100	1.3
623-125	M3 - .50 x 10	100	1.5
623-139	M4 - .70 x 16	100	2
623-201	M5 - .80 x 16	100	2.5
623-272	M6 - 1.0 x 20	100	3
623-322	M8 - 1.25 x 40	100	4
623-366	M10 - 1.5 x 20	100	5



**009
Series**

ORDER BY STOCK NUMBER

CLASS 8.8 STANDARD METRIC HEX BOLTS									
CL Part No.	Bulk Part No.	Size	Pcs per CL	Sleeve	CL Part No.	Bulk Part No.	Size	Pcs per CL	Sleeve
009-221	608-267	M6 - 1.00 x 12	14	4	009-240	608-372	M10 - 1.50 x 40	3	4
009-222	608-270	M6 - 1.00 x 16	12	4	009-241	608-374	M10 - 1.50 x 50	2	4
009-223	608-272	M6 - 1.00 x 20	10	4	009-242	608-376	M10 - 1.50 x 60	2	4
009-224	608-274	M6 - 1.00 x 25	8	4	009-243	608-378	M10 - 1.50 x 70	2	4
009-225	608-276	M6 - 1.00 x 30	7	4	009-244	608-412	M12 - 1.75 x 25	2	4
009-226	608-277	M6 - 1.00 x 35	4	4	009-245	608-415	M12 - 1.75 x 35	2	4
009-227	608-278	M6 - 1.00 x 40	4	4	009-246	608-416	M12 - 1.75 x 40	2	4
009-228	608-314	M8 - 1.25 x 16	10	4	009-247	608-418	M12 - 1.75 x 50	2	4
009-229	608-316	M8 - 1.25 x 20	9	4	009-248	608-420	M12 - 1.75 x 60	2	4
009-230	608-318	M8 - 1.25 x 25	8	4	009-249	608-422	M12 - 1.75 x 70	2	4
009-231	608-320	M8 - 1.25 x 30	7	4	009-156	609-370	M10 - 1.25 x 30	1	4
009-232	608-321	M8 - 1.25 x 35	4	4	009-157	609-372	M10 - 1.25 x 40	1	4
009-233	608-322	M8 - 1.25 x 40	5	4	009-158	609-374	M10 - 1.25 x 50	1	4
009-234	608-323	M8 - 1.25 x 45	5	4	009-159	609-414	M12 - 1.50 x 30	1	4
009-235	608-324	M8 - 1.25 x 50	4	4	009-160	609-416	M12 - 1.50 x 40	1	4
009-236	608-366	M10 - 1.50 x 20	5	4	009-161	609-418	M12 - 1.50 x 50	1	4
009-237	608-368	M10 - 1.50 x 25	4	4	009-162	610-414	M12 - 1.25 x 30	1	4
009-238	608-370	M10 - 1.50 x 30	4	4	009-163	610-416	M12 - 1.25 x 40	1	4
009-239	608-371	M10 - 1.50 x 35	3	4	009-164	610-418	M12 - 1.25 x 50	1	4

CLASS 10.9 STANDARD METRIC HEX BOLTS									
CL Part No.	Bulk Part No.	Size	Pcs per CL	Sleeve	CL Part No.	Bulk Part No.	Size	Pcs per CL	Sleeve
009-113	611-267	M6 - 1.00 x 12	4	4	009-008	613-320	M8 - 1.25 x 30	4	4
009-114	611-270	M6 - 1.00 x 16	4	4	009-009	613-321	M8 - 1.25 x 35	3	4
009-115	611-272	M6 - 1.00 x 20	4	4	009-010	613-322	M8 - 1.25 x 40	3	4
009-116	611-276	M6 - 1.00 x 30	4	4	009-011	613-323	M8 - 1.25 x 45	3	4
009-117	611-278	M6 - 1.00 x 40	2	4	009-012	613-324	M8 - 1.25 x 50	3	4
009-118	611-314	M8 - 1.25 x 16	3	4	009-013	613-366	M10 - 1.50 x 20	3	4
009-119	611-316	M8 - 1.25 x 20	3	4	009-014	613-368	M10 - 1.50 x 25	3	4
009-120	611-320	M8 - 1.25 x 30	2	4	009-015	613-370	M10 - 1.50 x 30	3	4
009-121	611-322	M8 - 1.25 x 40	2	4	009-016	613-371	M10 - 1.50 x 35	3	4
009-122	611-364	M10 - 1.25 x 16	2	4	009-017	613-372	M10 - 1.50 x 40	2	4
009-123	611-366	M10 - 1.25 x 20	2	4	009-018	613-374	M10 - 1.50 x 50	2	4
009-124	611-370	M10 - 1.25 x 30	2	4	009-019	613-376	M10 - 1.50 x 60	2	4
009-125	611-372	M10 - 1.25 x 40	2	4	009-020	613-378	M10 - 1.50 x 70	2	4
009-001	613-272	M6 - 1.00 x 20	9	4	009-021	613-414	M12 - 1.75 x 30	2	4
009-002	613-274	M6 - 1.00 x 25	8	4	009-022	613-415	M12 - 1.75 x 35	2	4
009-003	613-276	M6 - 1.00 x 30	7	4	009-023	613-416	M12 - 1.75 x 40	2	4
009-004	613-277	M6 - 1.00 x 35	6	4	009-024	613-418	M12 - 1.75 x 50	2	4
009-005	613-278	M6 - 1.00 x 40	5	4	009-025	613-420	M12 - 1.75 x 60	2	4
009-006	613-316	M8 - 1.25 x 20	5	4	009-026	613-422	M12 - 1.75 x 70	2	3
009-007	613-318	M8 - 1.25 x 25	4	4					

CLASS 8.8 HEX NUTS					CLASS 10.9 HEX NUTS				
CL Part No.	Bulk Part No.	Size	Pcs per CL	Sleeve	CL Part No.	Bulk Part No.	Size	Pcs per CL	Sleeve
009-250	670-006	M6 - 1.00	12	6	009-027	671-006	M6 - 1.00	12	6
009-251	670-008	M8 - 1.25	10	6	009-028	671-008	M8 - 1.25	10	6
009-252	670-010	M10 - 1.50	6	4	009-029	671-010	M10 - 1.50	6	4
009-253	670-012	M12 - 1.75	4	4	009-030	671-012	M12 - 1.75	4	4
009-165	670-210	M10 - 1.25	2	6	CLASS 10.9 FLANGE NUTS				
009-166	670-212	M12 - 1.50	2	6	009-126	244-996	M6 - 1.00	4	6
009-167	670-765	M12 - 1.25	2	6	009-127	244-997	M8 - 1.25	4	6
CLASS 8.8 FLAT WASHERS					009-128	244-998	M10 - 1.25	4	6
009-031	730-006	6 mm	16	6	ENGINE STUDS				
009-032	730-008	8 mm	12	6	009-329	264-230	M6 - 1.00 x 30	2	6
009-033	730-010	10 mm	8	6	009-330	264-338	M8 - 1.25 x 38	2	6
009-034	730-012	12 mm	6	6	009-331	264-346	M8 - 1.25 x 46	2	6
CLASS 8.8 LOCK WASHERS					009-332	264-348	M8 - 1.25 x 50	2	6
009-035	740-006	6 mm	16	6	009-333	264-451	M10 - 1.50 x 50	2	6
009-036	740-008	8 mm	12	6	009-334	264-453	M10 - 1.50 x 62	2	6
009-037	740-010	10 mm	10	4					
009-038	740-012	12 mm	8	4					

NUTS ÉCROUS

611
Series

CLASS 10



CLASS 10 ZINC HEX FLANGE NUTS			
Part No.	Dia. - Pitch	Pkg Qty	Case Qty
611-906	M6-1.00	100	4800
611-908	M8-1.25	100	3600
611-910	M10-1.50	50	1200
611-912	M12-1.75	50	1200

670
Series

CLASS 8

- High Tensile Nuts conform to ISO-Metric specifications



- Regular ISO Coarse Thread Series

CLASS 8 ZINC HEX NUTS				
Part No.	Dia. - Pitch	A/F (W)	Thick (T)	Qty
670-003	M3 - 0.50	5.5	2.4	100
670-004	M4 - 0.70	7	3.2	100
670-005	M5 - 0.80	8	4	100
670-006 ◊	M6 - 1.00	10	5	100
670-007	M7 - 1.00	10	5.5	100
670-008 ◊	M8 - 1.25	13	6.5	100
670-010 ◊	M10 - 1.50	17	8	100
670-012 ◊	M12 - 1.75	19	9.5	50
670-014	M14 - 2.00	22	11	25
670-016	M16 - 2.00	24	13	25
670-018	M18 - 2.50	27	15	25
670-020	M20 - 2.50	30	16	25
670-024	M24 - 3.00	36	18	25

A/F - Across Flats

670
Series

CLASS 8

- Fine Thread Zinc Dichromate Plated



CLASS 8 HEX NUTS - FINE & EXTRA FINE THREAD		
Part No.	Dia. - Pitch	Qty
670-208	M8 - 1.00	25
670-210 ◊	M10 - 1.25	25
670-212 ◊	M12 - 1.50	25
670-214	M14 - 1.50	25
670-216	M16 - 1.50	25
670-218	M18 - 1.50	25
670-220	M20 - 1.50	25
670-750	M10 - 1.00 EXTRA FINE	25
670-765 ◊	M12 - 1.25 EXTRA FINE	25

For **SUPER-SERVICE ASSORTMENT**
No. **020-842** of Metric Fasteners
please refer to page **10**.

671
Series

CLASS 10

- High Tensile Nuts conform to ISO-Metric specifications



- Regular ISO Coarse Thread Series

CLASS 10 BARE METAL HEX NUTS			
Part No.	Dia. - Pitch	A/F (W)	Qty
671-006 ◊	M6-1.00	10	100
671-008 ◊	M8-1.25	13	100
671-010 ◊	M10-1.50	17	100
671-012 ◊	M12-1.75	19	50
671-014	M14-2.00	22	25
671-016	M16-2.00	24	25
671-020	M20-2.50	30	25
671-024	M24-3.00	36	25

A/F - Across Flats

672
Series

CLASS 10

- High Tensile Nuts conform to ISO-Metric specifications



- Regular ISO Coarse Thread Series

CLASS 10 YELLOW ZINC HEX NUTS			
Part No.	Dia. - Pitch	A/F (W)	Qty
672-006	M6-1.00	10	100
672-008	M8-1.25	13	100
672-010	M10-1.50	17	100
672-012	M12-1.75	19	50
672-014	M14-2.00	22	25
672-016	M16-2.00	24	25
672-018	M18-2.50	27	25
672-020	M20-2.50	30	25
672-024	M24-3.00	36	25

A/F - Across Flats

672
Series

CLASS 10

- Heat Treated
- High Strength



- For Critical Applications

CLASS 10 YELLOW ZINC 'CONELOK' LOCKNUTS			
Part No.	Dia. - Pitch	A/F (W)	Qty
672-206	M6-1.00	10	100
672-208	M8-1.25	13	100
672-210	M10-1.50	17	100
672-212	M12-1.75	19	50
672-214	M14-2.00	22	25
672-216	M16-2.00	24	25
672-218	M18-2.50	27	25
672-220	M20-2.50	30	25
672-224	M24-3.00	36	25

A/F - Across Flats



These items are also available
in clamshell clear packs

**NUTS
ÉCROUS**

700 Series

POZI-LOK®
Regular ISO Coarse Thread Series



NYLON COLLAR LOCK NUTS				
Part No.	Dia. - Pitch	A/F (W)	Height (H)	Qty
700-004	M4 - 0.70	7	5.0	100
700-005	M5 - 0.80	8	5.0	100
700-006	M6 - 1.00	10	6.0	100
700-008	M8 - 1.25	13	8.0	100
700-010	M10 - 1.50	17	10.0	100
700-012	M12 - 1.75	19	12.0	50
700-016	M16 - 2.00	24	16.0	25

705 Series

TRI-LOK®
Regular ISO Coarse Thread Series



LOCK NUTS				
Part No.	Dia. - Pitch	A/F (W)	Height (H)	Qty
705-008	M8 - 1.25	13	6.5	100
705-010	M10 - 1.50	17	8.0	100
705-012	M12 - 1.75	19	10.0	50

All metal for high temperature applications.

705 Series

CLASS 8
Regular ISO Coarse Thread Series

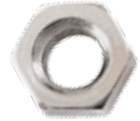

CLASS 8 ZINC HEX JAM NUTS				
Part No.	Dia. - Pitch	A/F (W)	Height (H)	Qty
705-016	M6 - 1.00	10	5.0	100
705-018	M8 - 1.25	13	6.5	100
705-020	M10 - 1.50	17	8.0	100
705-022	M12 - 1.75	19	10.0	50
705-024	M14 - 2.00	22	11.0	25
705-026	M16 - 2.00	24	13.0	25
705-028	M18 - 2.50	27	15.0	20
705-030	M20 - 2.50	30	16.0	20
705-032	M22 - 2.50	32	18.0	20
705-034	M24 - 3.00	36	19.0	20

These items are also available in clamshell clear packs

**FLAT WASHERS
RONDELLES ORDINAIRES**

730 Series

ISO 7089

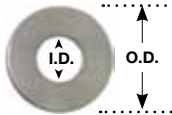

Hardness Class 200 HV

FLAT WASHERS					
Part No.	Bolt Size	I.D.	O.D.	Thick (T)	Qty
730-005	5 mm	5.3	11.0	1.0	100
730-006	6 mm	6.4	12.5	1.6	100
730-008	8 mm	8.4	17.0	1.6	100
730-010	10 mm	10.5	21.0	2.0	100
730-012	12 mm	13.0	24.0	2.5	50
730-014	14 mm	15.0	28.0	2.5	25
730-016	16 mm	17.0	30.0	3.0	25
730-018	18 mm	19.0	34.0	3.0	25
730-020	20 mm	21.0	37.0	3.0	25
730-024	24 mm	25.0	44.0	4.0	25

**FENDER WASHERS
RONDELLES DE PROTECTION**

730 Series

ISO 7093-1

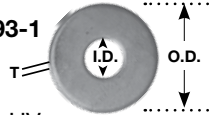

Hardness Class 200 HV

ZINC FENDER WASHERS					
Part No.	Bolt Size	I.D.	O.D.	Thick (T)	Qty
730-304	4 mm	4.3	12	1	100
730-305	5 mm	5.3	15	1	100
730-306	6 mm	6.4	18	1.6	100
730-308	8 mm	8.4	24	2.0	100
730-310	10 mm	10.5	30	2.5	50
730-312	12 mm	13	37	3	50
730-314	14 mm	15	44	3	25
730-316	16 mm	17	50	3	25

**LOCK WASHERS
RONDELLES À RESSORT**

740 Series

DIN 7980



Hardness Class 392 to 490 HV

LOCK WASHERS					
Part No.	Bolt Size	I.D.	O.D.	Thick (T)	Qty
740-004	4 mm	4.1	7.6	0.9	100
740-005	5 mm	5.1	9.2	1.2	100
740-006	6 mm	6.1	9.7	1.4	100
740-008	8 mm	8.2	12.8	1.9	100
740-010	10 mm	10.2	16.1	2.35	100
740-012	12 mm	12.2	18.3	2.35	50
740-014	14 mm	14.2	21.4	2.8	25
740-016	16 mm	16.2	24.6	3.3	25
740-018	18 mm	18.2	26.6	3.3	25
740-020	20 mm	20.2	30.6	4.3	25
740-024	24 mm	24.5	35.9	4.8	25

Suitable for use with Class 8.8 and 8 Fasteners

730 Series

ISO 7089

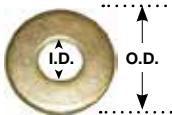

Hardness Class 300 HV

YELLOW ZINC FLAT WASHERS					
Part No.	Bolt Size	I.D.	O.D.	Thick (T)	Qty
730-406	6 mm	6.4	12.5	1.6	100
730-408	8 mm	8.4	17.0	1.6	100
730-410	10 mm	10.5	21.0	2.0	100
730-412	12 mm	13.0	24.0	2.5	50
730-414	14 mm	15.0	28.0	2.5	25
730-416	16 mm	17.0	30.0	3.0	25
730-418	18 mm	19.0	34.0	3.0	25
730-420	20 mm	21.0	37.0	3.0	25
730-424	24 mm	25.0	44.0	4.0	25

750 Series

ISO 7093-1

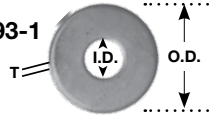

Hardness Class 300 HV

FENDER WASHERS					
Part No.	Bolt Size	I.D.	O.D.	Thick (T)	Qty
750-004	4 mm	4.3	12	1	100
750-005	5 mm	5.3	15	1	100
750-006	6 mm	6.4	18	1.6	100
750-008	8 mm	8.4	24	2.0	100
750-010	10 mm	10.5	30	2.5	50
750-012	12 mm	13	37	3	50

740 Series

DIN 127 B

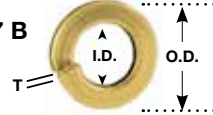

Hardness Class 430 to 530 HV

YELLOW ZINC LOCK WASHERS					
Part No.	Bolt Size	I.D.	O.D.	Thick (T)	Qty
740-404	4 mm	4.1	7.6	0.9	100
740-405	5 mm	5.1	9.2	1.2	100
740-406	6 mm	6.1	11.8	1.6	100
740-408	8 mm	8.1	14.8	2.0	100
740-410	10 mm	10.2	18.1	2.2	100
740-412	12 mm	12.2	21.1	2.5	50
740-414	14 mm	14.2	24.1	3.0	25
740-416	16 mm	16.2	27.4	3.5	25
740-418	18 mm	18.2	29.4	3.5	25
740-420	20 mm	20.2	33.6	4.0	25
740-424	24 mm	24.5	40.0	5.0	25

Suitable for use with Class 10.9 and 10 Fasteners

**BOLT BIN ASSORTMENTS
ASSORTIMENTS DE BOULONS**

No. 022KIT-02



**METRIC 8.8
BOLT AND NUT ASSORTMENT
(ZINC PLATED)**



Size	Quantity	Size	Quantity
M6 x 12	100	M12 x 25	25
M6 x 25	100	M12 x 35	25
M6 x 35	25	M12 x 50	25
M6 x 50	25	M12 x 60	25
M8 x 20	100	M12 x 70	25
M8 x 25	100	M12 x 100	10
M8 x 35	25	M16 x 35	10
M8 x 50	100	M16 x 50	10
M8 x 60	25	M16 x 60	10
M10 x 20	25	M16 x 70	10
M10 x 25	50	M16 x 100	10
M10 x 35	50	M20 x 40	5
M10 x 50	25	M20 x 50	5
M10 x 60	25	M20 x 60	5
M10 x 70	25	M20 x 70	5
M10 x 100	10	M20 x 100	5



Contains 3,315 pcs.
42" H x 36" W x 12" D
Base not included

Size	Nuts	Lockwashers	Flat Washers
M6	200 	200 	200 
M8	300	200	200
M10	200	200	200
M12	50	100	100
M16	25	25	25
M20	20	25	25

No. 022KIT-03



**METRIC 10.9
BOLT AND NUT ASSORTMENT
(ZINC PLATED)**



Size	Quantity	Size	Quantity
M6 x 12	100	M12 x 25	25
M6 x 25	100	M12 x 35	25
M6 x 35	25	M12 x 50	25
M6 x 50	25	M12 x 60	25
M8 x 20	100	M12 x 70	25
M8 x 25	100	M12 x 100	10
M8 x 35	25	M16 x 35	10
M8 x 50	100	M16 x 50	10
M8 x 60	25	M16 x 60	10
M10 x 20	25	M16 x 70	10
M10 x 25	50	M16 x 100	10
M10 x 35	50	M20 x 40	5
M10 x 50	25	M20 x 50	5
M10 x 60	25	M20 x 60	5
M10 x 70	25	M20 x 70	5
M10 x 100	10	M20 x 100	5



Contains 3,315 pcs.
42" H x 36" W x 12" D
Base not included

Size	Nuts	Lockwashers	Flat Washers
M6	200 	200 	200 
M8	300	200	200
M10	200	200	200
M12	50	100	100
M16	25	25	25
M20	20	25	25

METRIC FLANGE BOLTS BOULONS DE REBORD MÉTRIQUE

611
Series

- JIS SPEC B1189
- Serrated



ORDER BY STOCK NUMBER

CLASS 10.9 ZINC HEX FLANGE BOLTS

Part No.	Size	Pkg Qty	A/F	Part No.	Size	Pkg Qty	A/F
611-267 ◊	M6 x 1.0 x 12	20	10	611-332	M8 x 1.25 x 100	20	12
611-270 ◊	M6 x 1.0 x 16	20	10	611-334	M8 x 1.25 x 120	20	12
611-272 ◊	M6 x 1.0 x 20	20	10	611-364 ◊	M10 x 1.25 x 16	15	14
611-274	M6 x 1.0 x 25	20	10	611-366 ◊	M10 x 1.25 x 20	15	14
611-276 ◊	M6 x 1.0 x 30	20	10	611-368	M10 x 1.25 x 25	15	14
611-277	M6 x 1.0 x 35	20	10	611-370 ◊	M10 x 1.25 x 30	15	14
611-278 ◊	M6 x 1.0 x 40	20	10	611-371	M10 x 1.25 x 35	15	14
611-279	M6 x 1.0 x 45	20	10	611-372 ◊	M10 x 1.25 x 40	15	14
611-311	M8 x 1.25 x 12	20	12	611-373	M10 x 1.25 x 45	15	14
611-314 ◊	M8 x 1.25 x 16	20	12	611-374	M10 x 1.25 x 50	15	14
611-316 ◊	M8 x 1.25 x 20	20	12	611-376	M10 x 1.25 x 60	15	14
611-318	M8 x 1.25 x 25	20	12	611-378	M10 x 1.25 x 70	10	14
611-320 ◊	M8 x 1.25 x 30	20	12	611-380	M10 x 1.25 x 80	10	14
611-321	M8 x 1.25 x 35	20	12	611-412	M12 x 1.75 x 25	10	17
611-322 ◊	M8 x 1.25 x 40	20	12	611-414	M12 x 1.75 x 30	10	17
611-323	M8 x 1.25 x 45	20	12	611-415	M12 x 1.75 x 35	10	17
611-324	M8 x 1.25 x 50	15	12	611-416	M12 x 1.75 x 40	10	17
611-326	M8 x 1.25 x 60	15	12	611-418	M12 x 1.75 x 50	10	17
611-328	M8 x 1.25 x 70	15	12	611-420	M12 x 1.75 x 60	10	17
611-330	M8 x 1.25 x 80	20	12	611-424	M12 x 1.75 x 80	5	17

A/F – Across Flats

◊ This item is also available in clamshell clear pack. See page 34.

615
Series

- JIS SPEC B1189



CLASS 8.8 YELLOW ZINC HEX FLANGE BOLTS

Part No.	Size	Pkg Qty	A/F
615-205	M5 - .80 x 16	40	8
615-207	M5 - .80 x 20	40	8
615-253	M6 - 1.0 x 12	20	10
615-255	M6 - 1.0 x 16	20	10
615-257	M6 - 1.0 x 20	20	10
615-260	M6 - 1.0 x 25	20	10
615-266	M6 - 1.0 x 40	20	10
615-303	M8 - 1.25 x 12	20	12
615-305	M8 - 1.25 x 16	20	12
615-307	M8 - 1.25 x 20	20	12
615-310	M8 - 1.25 x 25	20	12
615-312	M8 - 1.25 x 30	20	12
615-314	M8 - 1.25 x 35	20	12
615-316	M8 - 1.25 x 40	20	12
615-357	M10 - 1.25 x 20	15	14
615-362	M10 - 1.25 x 30	15	14
615-364	M10 - 1.25 x 35	15	14
615-366	M10 - 1.25 x 40	15	14
615-370	M10 - 1.25 x 50	15	14
615-374	M10 - 1.25 x 60	15	14
615-378	M10 - 1.25 x 70	10	14
615-382	M10 - 1.25 x 80	10	14
615-410	M12 - 1.25 x 25	10	17
615-412	M12 - 1.25 x 30	10	17
615-414	M12 - 1.25 x 35	10	17
615-416	M12 - 1.25 x 40	10	17
615-420	M12 - 1.25 x 50	10	17
615-424	M12 - 1.25 x 60	10	17

BUMPER BAR BOLTS BOULONS DE PARE-CHOCS

245
Series

- Button Head
- Blue Zinc Plated

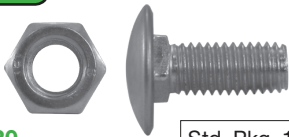

245-220

Std. Pkg. 10 pcs.

M8-1.25 x 25mm

Chrome Plated Capped
Bumper Bar Bolts W/Nuts

CL Part No: 910-1390, Pieces: 2

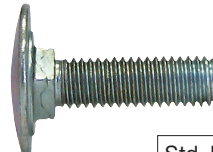

245-223

Std. Pkg. 10 pcs.

M8-1.25 x 27mm

Chrome Plated Uncapped
Bumper Bar Bolts

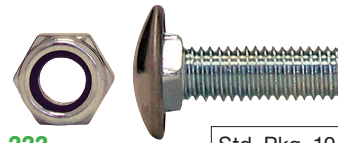

245-222

Std. Pkg. 10 pcs.

M8-1.25 x 28mm

Chrome Plated Stainless Steel Capped
Bumper Bar Bolts W/Nuts



245-221

Std. Pkg. 10 pcs.

M8-1.25 x 30mm

Uncapped
Bumper Bar Bolts W/Nuts

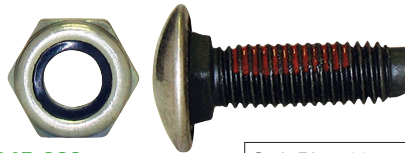

245-233

Std. Pkg. 10 pcs.

M10-1.5 x 33.5mm

Stainless Steel Capped
Bumper Bar Bolts W/Nuts

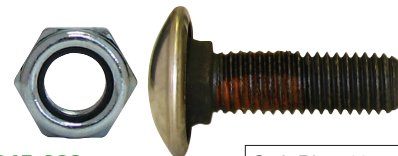

245-238

Std. Pkg. 10 pcs.

M12-1.75 x 40mm

Stainless Steel Capped
Bumper Bar Bolts W/Nuts

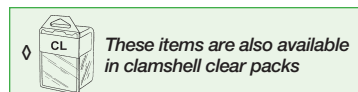

**FLANGE NUTS
ÉCROUS DE REBORD**



244-952 Pkg Qty: 50

M5-0.8

Free Spinning Washer Nut
Zinc & Yellow Plated • 10mm Washer O.D.
Hex Size: 8mm • Height: 7mm
N802775-S36

CL Part No: 910-0160 • Pieces: 4



244-953 Pkg Qty: 25

M5-0.8

FORD • Washer Nut
Phosphate Coated • 15mm Washer O.D.
Hex Size: 10mm • Height: 7mm
N621903



244-955 Pkg Qty: 25

M6-1.0

CHRYSLER • Washer Nut
Phosphate Coated • 18mm Washer O.D.
Hex Size: 10mm • Height: 9mm
6100048

CL Part No: 910-0130 • Pieces: 4



244-956 Pkg Qty: 25

M6-1.0

GM, FORD • Free Spinning Washer Nut
Phosphate Coated • 16mm Washer O.D.
Hex Size: 10mm • Height: 7mm
GM 11503752, 1150329, VW N90100001

CL Part No: 910-0125 • Pieces: 4



244-957 Pkg Qty: 25

M6-1.0

Free Spinning Washer Nut
Phosphate Coated • 20mm Washer O.D.
Hex Size: 10mm • Height: 9mm
6100049

CL Part No: 910-0170 • Pieces: 2



244-958 Pkg Qty: 25

M6-3-1.0

GM • Free Spinning Washer Nut
Phosphate Coated • 16 mm Washer O.D.,
Hex Size: 11mm • Height: 9mm
11500747, 11501106

CL Part No: 910-0175 • Pieces: 3



244-959 Pkg Qty: 100

M8-1.25

GM
Spin Lock Nuts With Serrations
Case Hardened, Phosphate Coated
19mm Washer O.D. • Hex Size: 13mm

CL Part No: 910-0180 • Pieces: 4



244-970 Pkg Qty: 50

M5-0.8

Hex Flange Nut
Black Oxide • 11.5mm Washer O.D.
Hex Size: 8mm • Height: 5mm

CL Part No: 910-0120 • Pieces: 3



244-985 Pkg Qty: 25

M6-1.0

Spin Lock Nuts With Serrations
Case Hardened, Phosphate Coated
17mm Washer O.D. • Hex Size: 10mm

CL Part No: 910-0165 • Pieces: 6



244-986 Pkg Qty: 25

M6-1.0

GM • Flange Nut
Phosphate • 14mm Washer O.D.
Hex Size: 10mm • Height: 6mm
11503745



244-987 Pkg Qty: 25

M8-1.25

GM • Flange Nut
Phosphate Coated • 17mm Washer O.D.,
Hex Size: 13mm, Height: 8mm
11501889

CL Part No: 910-0135 • Pieces: 4



244-988 Pkg Qty: 25

M10-1.5

GM • Flange Nut
Phosphate Coated • 21mm Washer O.D.
Hex Size: 15mm • Height: 10mm
11501850

CL Part No: 910-0150 • Pieces: 3



244-996 Pkg Qty: 25

M6-1.0

Spin Lock Nuts With Serrations
Zinc Plated • 14mm Washer O.D.
Hex Size: 10mm • Height: 6mm

CL Part No: 009-126 • Pieces: 4



244-997 Pkg Qty: 25

M8-1.25

Spin Lock Nuts With Serrations
Zinc Plated • 17mm Washer O.D.
Hex Size: 12mm • Height: 8mm

CL Part No: 910-0140 • Pieces: 3



244-998 Pkg Qty: 25

M10-1.25

Spin Lock Nuts With Serrations
Zinc Plated • 19mm Washer O.D.
Hex Size: 14mm • Height: 10.5mm

CL Part No: 910-0145 • Pieces: 2

For a more comprehensive listing of these parts, please refer to our current Body Shop Fastener Catalogue.

**TAPPING SCREWS
VIS TARAUEUSES**

**230
Series**



Std Pkg: 100 pcs

PAN POZI-DRIV [®] HEAD CHROME PLATED			
Part No.	Dia. x Length	Qty	
230-203	4.2 x 13 mm	100	
230-205	4.2 x 20 mm	100	
230-206	4.2 x 20mm	100	

**230
Series**



Std Pkg: 100 pcs

OVAL POZI-DRIV [®] HEAD CHROME PLATED			
Part No.	Dia. x Length	Qty	
230-207	4.2 x 20mm	100	

**230
Series**

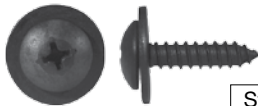

Std Pkg: 100 pcs

SPECIAL TAPPING SCREWS BLACK				
Part No.	Dia. x Length	Qty	CL Part #	Pcs
230-619	M4.8 - 1.61 x 19 mm	100	910-1275	3

**230
Series**

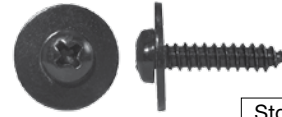

Std Pkg: 100 pcs

SPECIAL TAPPING SCREWS BLACK				
Part No.	Dia. x Length	Qty	CL Part #	Pcs
230-623	M2 - 1.41 x 20 mm	100	970-1270	3

**245
Series**



Std Pkg: 100 pcs

HEX WASHER HEAD SCREWS		
Part No.	Dia. x Length	Qty
245-407	M6 - 1.0 x 25 mm	25
245-408	M6 - 1.0 x 25 mm	25
245-405	M6 - 1.0 x 20 mm	25
245-320	M5 - 0.8 x 20 mm	25
245-405	M6 - 1.0 x 20 mm	25
245-450	M10 - 1.5 x 40 mm	15
245-526	M8 - 1.25 x 25 mm	25
245-440	M8 - 1.25 x 30 mm	25
245-510	M8 - 1.0 x 35 mm	25

**TRIM SCREWS
VIS FINITION**

**230
Series**



Std Pkg: 100 pcs

ROUND WASHER HEAD POZI-DRIV [®] - Chrome Plated			
Part No.	Dia. x Length	Qty	
230-301	4.2 x 8 mm	100	
230-302	4.2 x 12 mm	100	
230-304	4.2 x 16 mm	100	
230-305	4.2 x 20 mm	100	

ROUND WASHER HEAD POZI-DRIV [®] - Black Oxide				
Part No.	Dia. x Length	Qty	CL Part #	Pcs
230-303	4.2 x 12 mm	100	-	-
230-306	4.2 x 20 mm	100	970-1245	10

**MACHINE SCREWS
VIS MÉCANIQUES**

**771
Series**

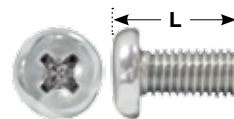

Std Pkg: 100 pcs

PAN PHILLIPS HEAD MACHINE SCREWS			
Part No.	Size	Part No.	Size
771-123	M3 - 0.5 x 6	771-198	M5 - 0.8 x 12
771-125	M3 - 0.5 x 10	771-201	M5 - 0.8 x 16
771-126	M3 - 0.5 x 16	771-203	M5 - 0.8 x 20
771-127	M3 - 0.5 x 20	771-205	M5 - 0.8 x 25
771-128	M3 - 0.5 x 25	771-206	M5 - 0.8 x 30
771-129	M3 - 0.5 x 30	771-207	M5 - 0.8 x 35
771-130	M3 - 0.5 x 35	771-208	M5 - 0.8 x 40
771-131	M3 - 0.5 x 50	771-211	M5 - 0.8 x 50
771-132	M4 - 0.7 x 6	771-265	M6 - 1.0 x 8
771-134	M4 - 0.7 x 10	771-266	M6 - 1.0 x 10
771-136	M4 - 0.7 x 12	771-267	M6 - 1.0 x 12
771-139	M4 - 0.7 x 16	771-270	M6 - 1.0 x 16
771-141	M4 - 0.7 x 20	771-272	M6 - 1.0 x 20
771-143	M4 - 0.7 x 25	771-274	M6 - 1.0 x 25
771-145	M4 - 0.7 x 30	771-276	M6 - 1.0 x 30
771-146	M4 - 0.7 x 35	771-277	M6 - 1.0 x 35
771-147	M4 - 0.7 x 40	771-278	M6 - 1.0 x 40
771-149	M4 - 0.7 x 50	771-280	M6 - 1.0 x 50
771-151	M4 - 0.7 x 60	771-311	M8 - 1.25 x 12
771-195	M5 - 0.8 x 6	771-320	M8 - 1.25 x 30
771-197	M5 - 0.8 x 10	771-322	M8 - 1.25 x 40

For a more comprehensive listing of these parts, please refer to our current Body Shop Fastener Catalogue.

'U' NUTS
ÉCROUS 'U'



241-606 Std. Pkg. 25 pcs.

Screw Size: M6-1.0

FORD, GM
Metric 'U' Nut
Ctr. of Hole to Edge: 13.5 mm, Panel Range: .80 mm - 4 mm
11503957, 1016937, N623332-S2, N623332-S53, N623332-S100

CL Part No: 910-1420 • Pieces: 3



241-607 Std. Pkg. 25 pcs.

Screw Size: M6-1.0

GM
Metric 'U' Nut
Ctr. of Hole to Edge: 19.5mm, Panel Range: .34mm - 4mm
11503715, 11508241, 11609385

CL Part No: 910-1421 • Pieces: 2



241-608 Std. Pkg. 25 pcs.

Screw Size: M8 -1.25

FORD, GM
Metric 'U' Nut
Ctr. of Hole to Edge: 20 mm, Panel Range: .80 mm - 4.5 mm
11500661, 11503317, 11516150, N623343-S2, N623343-S100

CL Part No: 910-1430 • Pieces: 2



241-609 Std. Pkg. 25 pcs.

Screw Size: M8-1.25

CHRYSLER, FORD, GM
Metric 'U' Nut
Ctr. of Hole to Edge: 14.5 mm, Panel Range: .80 mm - 4 mm
11500660, 11502617, N623333-S2, 6101283

CL Part No: 910-1427 • Pieces: 3



241-610 Std. Pkg. 10 pcs.

Screw Size: M10-1.5

GM
Metric 'U' Nut
Ctr. of Hole to Edge: 19 mm, Panel Range: 1 mm - 6 mm
11500662, 22531616

CL Part No: 910-1435 • Pieces: 2



241-612 Std. Pkg. 25 pcs.

Screw Size: M6-3 x 1.0

Metric 'U' Nut
Ctr. of Hole to Edge: 13.5 mm, Panel Range: .80 mm - 4 mm
11500658, 9433043

CL Part No: 910-1425 • Pieces: 3

For a more comprehensive listing of these parts, please refer to our current Body Shop Fastener Catalogue.

**BOLT RETAINERS
RETENUES DE BOULONS**



243-305	Std. Pkg. 100 pcs.
Stud Size: M5-0.8	
Push-On Bolt Retainer 11mm O.D.	
CL Part No: 910-1755 • Pieces: 10	



243-306	Std. Pkg. 100 pcs.
Stud Size: M6	
Push-On Bolt Retainer 17mm O.D.	
CL Part No: 910-1756 • Pieces: 10	



243-307	Std. Pkg. 100 pcs.
Stud Size: M6.3	
Push-On Bolt Retainer 14.3mm O.D.	

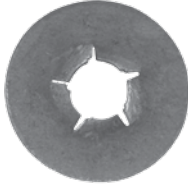

243-308	Std. Pkg. 100 pcs.
Stud Size: M8	
Push-On Bolt Retainer 24 mm O.D.	
CL Part No: 910-1757 • Pieces: 8	



243-310	Std. Pkg. 100 pcs.
Stud Size: M10	
Push-On Bolt Retainer 24 mm O.D.	



243-312	Std. Pkg. 100 pcs.
Stud Size: M12	
Push-On Bolt Retainer 21.4 mm O.D.	
CL Part No: 910-1759 • Pieces: 8	

**BODY BOLTS
BOULONS DE CARROSSERIE**



245-310	Std. Pkg. 50 pcs.
M4.2-1.41 x 20 mm	
GM Body Bolt Phosphate Hex Head Sems® 12 mm Washer O.D. • Hex Size: 7 mm 11504056, 11513801	
CL Part No: 910-1285 • Pieces: 6	

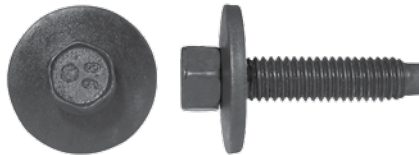

245-315	Std. Pkg. 25 pcs.
M6-1.0 x 28 mm	
FORD Body Bolt Phosphate Hex Head Sems® With Dog Point 19 mm Washer O.D. • Hex Size: 8 mm N606677-S43B	
CL Part No: 910-0060 • Pieces: 4	

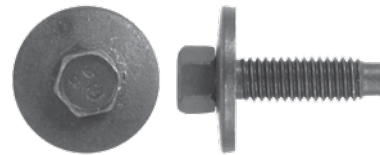

245-322	Std. Pkg. 25 pcs.
M6-1.0 x 22 mm	
FORD Body Bolt Phosphate 19 mm Washer O.D. • Hex Size: 8 mm N606676-S2, N606676-S100	
CL Part No: 910-0046 • Pieces: 4	

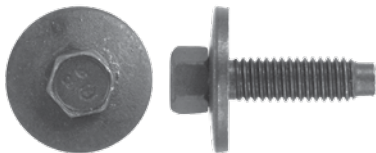

245-323	Std. Pkg. 25 pcs.
M6-1.0 x 28 mm	
FORD Hex Head Sems® With Dog Point 19 mm Washer O.D. • Hex Size: 8 mm Class 9.8 • N606677-S36	
CL Part No: 910-0057 • Pieces: 3	

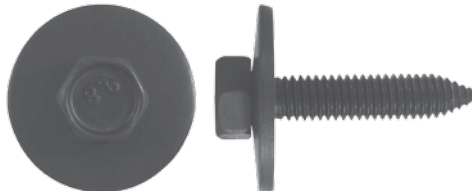

245-324	Std. Pkg. 25 pcs.
M6-1.0 x 30 mm	
GM Hex Head Sems® 24 mm Washer O.D. • Hex Size: 10 mm Class 9.8 • 11503825	

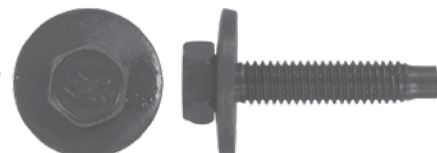

245-325	Std. Pkg. 25 pcs.
M6-1.0 x 30 mm	
CHRYSLER Body Bolt Phosphate 19 mm Washer O.D., Hex Size: 10 mm 6100568	

For a more comprehensive listing of these parts, please refer to our current Body Shop Fastener Catalogue.

**BODY BOLTS
BOULONS DE CARROSSERIE**



245-326 Std. Pkg. 50 pcs.

M5-0.8 x 20 mm
CHRYSLER Hex Head Sems[®] with Dog Point 12 mm Washer O.D. • Hex Size: 8 mm 6100539
CL Part No: 910-0035 • Pieces: 5

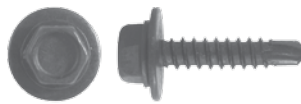

245-399 Std. Pkg. 25 pcs.

M4.2-1.41 x 20 mm
Hex Head Sems[®] With Teks[®] Point 12 mm Head O.D. • Hex Size: 7 mm Not Available through OEM.
CL Part No: 910-0057 • Pieces: 3



245-400 Std. Pkg. 25 pcs.

M4.2-1.41 x 20 mm
GM Indented Hex Head Sems[®] Phosphate 16 mm Washer O.D. • Hex Size: 7 mm 11500434, 11503892, 1640810
CL Part No: 910-0030 • Pieces: 5



245-405 Std. Pkg. 25 pcs.

M6-1.0 x 20 mm
GM Body Bolt Phosphate 17 mm Washer O.D. • Hex Size: 10 mm 11502941, 11506174
CL Part No: 910-0043 • Pieces: 3

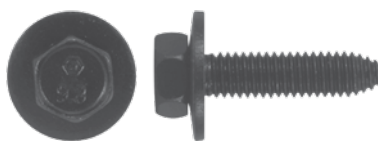

245-407 Std. Pkg. 25 pcs.

M6-1.0 x 25 mm
GM Body Bolt Phosphate 17 mm Washer O.D. • Hex Size: 10 mm 1503834, 20351035
CL Part No: 910-0050 • Pieces: 5

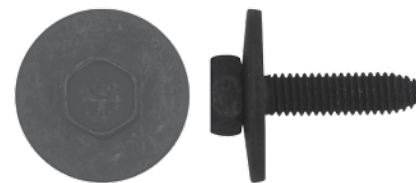

245-408 Std. Pkg. 25 pcs.

M6-1.0 x 25 mm
GM Body Bolt Phosphate 24 mm Washer O.D. • Hex Size: 10 mm 11503982
CL Part No: 910-0053 • Pieces: 4



245-420 Std. Pkg. 25 pcs.

M6.3-1.0 x 20 mm
GM Body Bolt Phosphate 17 mm Washer O.D. • Hex Size: 10 mm 11501105
CL Part No: 910-0070 • Pieces: 4

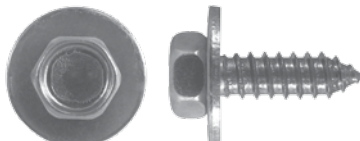

245-421 Std. Pkg. 25 pcs.

M6.3-1.81 x 20 mm
HONDA, NISSAN, TOYOTA Hex Head Sems[®] 18 mm Washer O.D. • Hex Size: 10 mm Not Available through OEM.

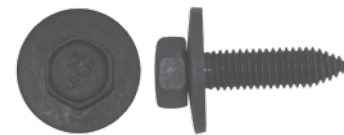

245-424 Std. Pkg. 25 pcs.

M6.3-1.0 x 25 mm
Body Bolt Phosphate 18 mm Washer O.D. 11500754

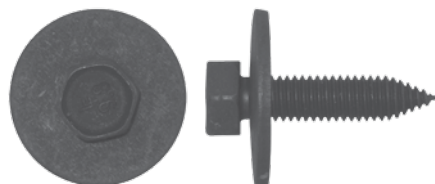

245-425 Std. Pkg. 25 pcs.

M6.3-1.0 x 25 mm
Body Bolt Phosphate 24 mm Washer O.D. 365718

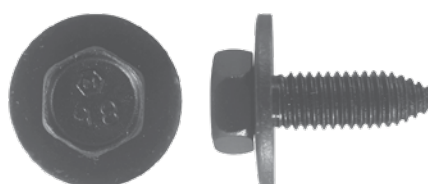

245-439 Std. Pkg. 25 pcs.

M8-1.25 x 25 mm
GM Hex Head Sems[®] 24 mm Washer O.D., Hex Size: 13 mm 11503619

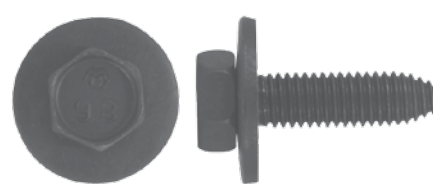

245-440 Std. Pkg. 25 pcs.

M8-1.25 x 30 mm
GM Body Bolt Phosphate 24 mm Washer O.D. • Hex Size: 13 mm 1501188
CL Part No: 910-0090 • Pieces: 2

For a more comprehensive listing of these parts, please refer to our current Body Shop Fastener Catalogue.

**BODY BOLTS
BOULONS DE CARROSSERIE**



245-441	Std. Pkg. 25 pcs.
M8-1.25 x 30 mm	
GM Body Bolt Phosphate 17 mm Washer O.D. • Hex Size: 13 mm 11500971	
CL Part No: 910-0085 • Pieces: 3	

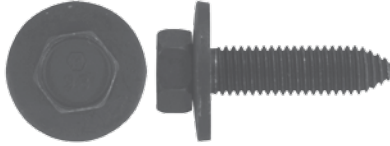

245-450	Std. Pkg. 15 pcs.
M10-1.5 x 40 mm	
GM Body Bolt Phosphate 29 mm Washer O.D. • Hex Size: 15 mm 11501193	
CL Part No: 910-0100 • Pieces: 2	



245-505	Std. Pkg. 25 pcs.
M6-1.0 x 20 mm	
GM Indented Hex Head Body Bolt Phosphate 13 mm Washer O.D. • Hex Size: 10 mm 11503800	
CL Part No: 910-0040 • Pieces: 4	

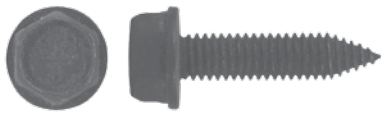

245-507	Std. Pkg. 25 pcs.
M6-1.0 x 25 mm	
GM Indented Hex Head Body Bolt Phosphate 13 mm Washer O.D. • Hex Size: 10 mm 11503958	



245-510	Std. Pkg. 15 pcs.
M6-1.0 x 35 mm	
GM Indented Hex Head Body Bolt Phosphate 17 mm Washer O.D. • Hex Size: 10 mm 11505044	
CL Part No: 910-0065 • Pieces: 3	

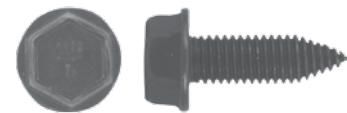

245-525	Std. Pkg. 25 pcs.
M8-1.25 x 25 mm	
GM Indented Hex Head Body Bolt Phosphate 17 mm Washer O.D. • Hex Size: 13 mm 11503632	

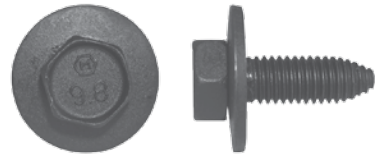

245-526	Std. Pkg. 25 pcs.
M8-1.25 x 25 mm	
GM Hex Head Sems[®] Body Bolt Phosphate 24 mm Washer O.D. • Hex Size: 13 mm 11503619	
CL Part No: 910-0075 • Pieces: 2	



245-527	Std. Pkg. 15 pcs.
M8-1.25 x 30 mm	
GM Indented Hex Head Body Bolt Phosphate 17 mm Washer O.D. • Hex Size: 13 mm 11500971	
CL Part No: 910-0080 • Pieces: 2	

For a more comprehensive listing of these parts, please refer to our current Body Shop Fastener Catalogue.

LICENCE PLATE SCREWS VIS POUR LICENCE



230-616	Std. Pkg. 50 pcs.
M6-1.0 x 20 mm	
CHRYSLER, HONDA & AMC Zinc Plated Slotted Hex Washer Head Licence Plate Screw 13 mm Washer O.D. • Hex Size: 10 mm, CHRY 34201287, AMC 8934201287	
CL Part No: 910-1190 • Pieces: 4	

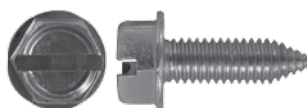

245-613	Std. Pkg. 50 pcs.
M6-1.0 x 20 mm	
CHRYSLER, FORD, AMC Zinc Plated Slotted Hex Washer Head Licence Plate Screw 13 mm Washer O.D. • Hex Size: 10 mm CHRY 34201287, AMC 8934201287	



245-911	Std. Pkg. 25 pcs.
M6-1.81 x 20 mm	
HONDA 1990-on, TOYOTA Phillips Hex Washer Head Licence Plate Screw Head O.D. • Hex Size: 10 mm TOYOTA 93904-46320, HONDA 91500-SM4-999AH	

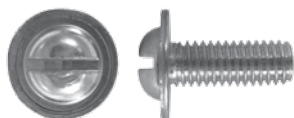

245-912	Std. Pkg. 25 pcs.
M6-1.0 x 16 mm	
Slotted Round Washer Head Licence Plate Screw Head O.D. 14 mm	

RODS TIGES

141
Series

CLASS 4.8

- ISO Coarse Thread
- Fully Threaded Steel Rods
- Bright Zinc Plated



CLASS 4.8 PLATED UNI-RODS® - 1M		
Part No.	Size	Qty
141-706	M6 x 1.00	10
141-708	M8 x 1.25	10
141-710	M10 x 1.50	10
141-712	M12 x 1.75	5
141-714	M14 x 2.00	5
141-716	M16 x 2.00	5
141-718	M18 x 2.50	3
141-720	M20 x 2.50	3
141-724	M24 x 3.00	3

141
Series

CLASS 10.9

- ISO Coarse Thread
- Fully Threaded Steel Rods

CLASS 10.9 YELLOW ZINC UNI-RODS® - 1M		
Part No.	Size	Qty
141-806	M6 x 1.00	10
141-808	M8 x 1.25	10
141-810	M10 x 1.50	10
141-812	M12 x 1.75	5
141-814	M14 x 2.00	5
141-816	M16 x 2.00	5
141-818	M18 x 2.50	3
141-820	M20 x 2.50	3
141-824	M24 x 3.00	3

STUDS GOUJONS

264
Series



ENGINE STUDS			
Part No.	Dia x Length	Pkg Qty	Case Qty
264-230	M6 - 1.00 x 30	10	840
264-338	M8 - 1.25 x 38	10	840
264-339	M8 - 1.25 x 40	10	840
264-346	M8 - 1.25 x 46	10	840
264-348	M8 - 1.25 x 50	10	480
264-640	M8 - 1.25 x 40	10	840
264-327	M8 - 1.0 x 40	10	840
264-449	M10 - 1.5 x 40	10	840
264-451	M10 - 1.5 x 50	10	480
264-453	M10 - 1.50 x 62	10	360
264-454	M10 - 1.5 x 60	10	360
264-442	M10 - 1.25 x 40	10	840
264-450	M10 - 1.25 x 50	10	480
264-459	M12 - 1.75 x 35	10	840
264-460	M12 - 1.5 x 35	10	840
264-461	M12 - 1.5 x 40	10	840
264-462	M12 - 1.25 x 50	10	480

COTTER PINS GOUPILES

752
Series



COTTER PINS			
Part No.	Dia x Length	Pkg Qty	Case Qty
752-006	1.5 x 16	100	7500
752-015	2 x 20	100	7500
752-024	3 x 25	100	7500
752-027	3 x 40	100	3200
752-037	4 x 50	100	2000

 These items are also available in clamshell clear packs

**METRIC 18.8 STAINLESS STEEL HEX HEAD CAP SCREWS
BOULONS HEX ACIER INOXYDABLE MÉTRIQUE 18,8**

5900
Series

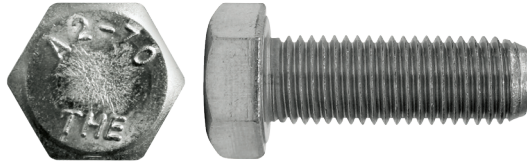

ORDER BY STOCK NUMBER

M6 Diameter - Across Flats 10 mm		
Part No.	Dia x Length	Pkg Qty
5900-305	M6 - 1.0 x 12 mm	50
5900-306	M6 - 1.0 x 16 mm	50
5900-307	M6 - 1.0 x 20 mm	50
5900-309	M6 - 1.0 x 25 mm	50
5900-310	M6 - 1.0 x 30 mm	50
5900-311	M6 - 1.0 x 35 mm	50
5900-312	M6 - 1.0 x 40 mm	50
5900-315	M6 - 1.0 x 45 mm	25
5900-316	M6 - 1.0 x 50 mm	25
5900-317	M6 - 1.0 x 60 mm	25

M8 Diameter - Across Flats 13 mm		
Part No.	Dia x Length	Pkg Qty
5900-405	M8 - 1.25 x 12	50
5900-406	M8 - 1.25 x 16	50
5900-407	M8 - 1.25 x 20	50
5900-409	M8 - 1.25 x 25	50
5900-410	M8 - 1.25 x 30	50
5900-411	M8 - 1.25 x 35	50
5900-412	M8 - 1.25 x 40	50
5900-415	M8 - 1.25 x 45	25
5900-416	M8 - 1.25 x 50	25
5900-417	M8 - 1.25 x 60	15
5900-419	M8 - 1.25 x 70	15
5900-420	M8 - 1.25 x 80	15

M10 Diameter - Across Flats 16 mm		
Part No.	Dia x Length	Pkg Qty
5900-507	M10 - 1.5 x 20	50
5900-509	M10 - 1.5 x 25	50
5900-510	M10 - 1.5 x 30	50
5900-511	M10 - 1.5 x 35	50
5900-512	M10 - 1.5 x 40	50
5900-515	M10 - 1.5 x 45	25
5900-516	M10 - 1.5 x 50	25
5900-517	M10 - 1.5 x 60	10
5900-519	M10 - 1.5 x 70	10
5900-520	M10 - 1.5 x 80	10
5900-522	M10 - 1.5 x 90	10
5900-524	M10 - 1.5 x 100	10

M12 Diameter - Across Flats 18 mm		
Part No.	Dia x Length	Pkg Qty
5900-609	M12 - 1.75 x 25	25
5900-610	M12 - 1.75 x 30	25
5900-611	M12 - 1.75 x 35	25
5900-612	M12 - 1.75 x 40	25
5900-615	M12 - 1.75 x 45	15
5900-616	M12 - 1.75 x 50	15
5900-617	M12 - 1.75 x 60	10
5900-619	M12 - 1.75 x 70	10
5900-620	M12 - 1.75 x 80	10
5900-622	M12 - 1.75 x 90	5
5900-624	M12 - 1.75 x 100	5

M16 Diameter - Across Flats 24 mm		
Part No.	Dia x Length	Pkg Qty
5900-709	M16 - 2.0 x 25	5
5900-710	M16 - 2.0 x 30	5
5900-711	M16 - 2.0 x 35	5
5900-712	M16 - 2.0 x 40	5
5900-715	M16 - 2.0 x 45	5
5900-716	M16 - 2.0 x 50	5
5900-717	M16 - 2.0 x 60	5
5900-719	M16 - 2.0 x 70	5
5900-720	M16 - 2.0 x 80	5
5900-722	M16 - 2.0 x 90	5
5900-724	M16 - 2.0 x 100	5

M20 Diameter - Across Flats 30 mm		
Part No.	Dia x Length	Pkg Qty
5900-815	M20 - 2.5 x 45	5
5900-816	M20 - 2.5 x 50	5
5900-817	M20 - 2.5 x 60	5
5900-819	M20 - 2.5 x 70	5
5900-820	M20 - 2.5 x 80	5
5900-822	M20 - 2.5 x 90	5
5900-824	M20 - 2.5 x 100	5
5900-826	M20 - 2.5 x 120	5
5900-828	M20 - 2.5 x 130	5
5900-830	M20 - 2.5 x 150	5

**METRIC 18.8 STAINLESS STEEL SOCKET HEAD CAP SCREWS
BOULONS DE PRESSION ACIER INOXYDABLE MÉTRIQUE 18,8**

5914
Series

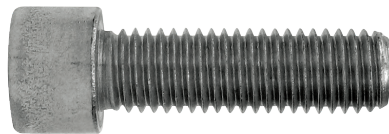

ORDER BY STOCK NUMBER

M5 Diameter - Hex Size 4 mm		
Part No.	Dia x Length	Pkg Qty
5914-203	M5 - 0.8 x 10	50
5914-205	M5 - 0.8 x 12	50
5914-206	M5 - 0.8 x 16	50
5914-207	M5 - 0.8 x 20	50
5914-209	M5 - 0.8 x 25	50
5914-210	M5 - 0.8 x 30	50
5914-211	M5 - 0.8 x 35	50

M6 Diameter - Hex Size 5 mm		
Part No.	Dia x Length	Pkg Qty
5914-303	M6 - 1.0 x 10	50
5914-305	M6 - 1.0 x 12	50
5914-306	M6 - 1.0 x 16	50
5914-307	M6 - 1.0 x 20	50
5914-309	M6 - 1.0 x 25	50
5914-310	M6 - 1.0 x 30	25
5914-311	M6 - 1.0 x 35	25
5914-312	M6 - 1.0 x 40	25

M4 Diameter - Hex Size 3 mm		
Part No.	Dia x Length	Pkg Qty
5914-102	M4 - 0.7 x 8	50
5914-103	M4 - 0.7 x 10	50
5914-105	M4 - 0.7 x 12	50
5914-106	M4 - 0.7 x 16	50
5914-107	M4 - 0.7 x 20	50
5914-109	M4 - 0.7 x 25	50

M8 Diameter - Hex Size 6 mm		
Part No.	Dia x Length	Pkg Qty
5914-406	M8 - 1.25 x 16	50
5914-407	M8 - 1.25 x 20	50
5914-409	M8 - 1.25 x 25	50
5914-410	M8 - 1.25 x 30	25
5914-411	M8 - 1.25 x 35	25
5914-412	M8 - 1.25 x 40	25
5914-415	M8 - 1.25 x 45	25
5914-416	M8 - 1.25 x 50	15
5914-417	M8 - 1.25 x 55	15
5914-418	M8 - 1.25 x 60	15

M10 Diameter - Hex Size 8 mm		
Part No.	Dia x Length	Pkg Qty
5914-507	M10 - 1.5 x 20	50
5914-509	M10 - 1.5 x 25	50
5914-510	M10 - 1.5 x 30	25
5914-511	M10 - 1.5 x 35	25
5914-512	M10 - 1.5 x 40	15
5914-515	M10 - 1.5 x 45	15
5914-516	M10 - 1.5 x 50	10
5914-517	M10 - 1.5 x 55	10
5914-518	M10 - 1.5 x 60	10
5914-519	M10 - 1.5 x 70	10

M12 Diameter - Hex Size 10 mm		
Part No.	Dia x Length	Pkg Qty
5914-610	M12 - 1.75 x 30	20
5914-611	M12 - 1.75 x 35	20
5914-612	M12 - 1.75 x 40	15
5914-615	M12 - 1.75 x 45	15
5914-616	M12 - 1.75 x 50	15
5914-617	M12 - 1.75 x 55	10
5914-618	M12 - 1.75 x 60	5
5914-619	M12 - 1.75 x 70	5

M16 Diameter - Hex Size 14 mm		
Part No.	Dia x Length	Pkg Qty
5914-710	M16 - 2.0 x 30	5
5914-711	M16 - 2.0 x 35	5
5914-712	M16 - 2.0 x 40	5
5914-715	M16 - 2.0 x 45	5
5914-716	M16 - 2.0 x 50	5
5914-717	M16 - 2.0 x 55	5
5914-718	M16 - 2.0 x 60	5
5914-719	M16 - 2.0 x 70	5

METRIC 18.8 STAINLESS STEEL HEX NUTS, WASHERS AND SCREWS
ÉCROUS HEX, RONDELLES ET VIS ACIER INOXYDABLE MÉTRIQUE 18,8

5901
Series



FINISHED HEX NUTS			
Part No.	Bolt Dia. (mm)	Pkg Qty	A/F
5901-008	M4 - 0.7	50	7 mm
5901-010	M5 - 0.8	50	8 mm
5901-014	M6 - 1.0	50	10 mm
5901-016	M8 - 1.25	50	13 mm
5901-018	M10 - 1.5	50	16 mm
5901-022	M12 - 1.75	25	18 mm
5901-024	M16 - 2.0	5	24 mm
5901-026	M20 - 2.5	5	30 mm

A/F - Across flats

5904
Series



NYLON INSERT STOP NUTS			
Part No.	Bolt Dia. (mm)	Pkg Qty	A/F
5904-014	M6 - 1.0	50	10 mm
5904-016	M8 - 1.25	50	13 mm
5904-018	M10 - 1.5	50	16 mm
5904-022	M12 - 1.75	25	18 mm
5904-024	M16 - 2.0	5	24 mm
5904-026	M20 - 2.5	5	30 mm
5904-028	M24 - 3.0	5	36 mm

A/F - Across flats

5908
Series



FLAT WASHERS					
Part No.	Bolt Dia. (mm)	Inside Dia.	Outside Dia.	Thickness	Pkg Qty
5908-214	6 mm	6.4	12.5	1.6	50
5908-216	8 mm	8.4	17.0	1.6	50
5908-218	10 mm	10.5	21.0	2.0	50
5908-222	12 mm	13.0	24.0	2.5	25
5908-224	16 mm	17.0	30.0	3.0	5
5908-226	20 mm	21.0	37.0	3.0	5

5909
Series



MEDIUM LOCK WASHERS					
Part No.	Bolt Dia. (mm)	Inside Dia.	Outside Dia.	Thickness	Pkg Qty
5909-014	6 mm	6.1	11.8	1.6	50
5909-016	8 mm	8.1	14.8	2.0	50
5909-018	10 mm	10.2	18.1	2.2	50
5909-022	12 mm	12.2	21.1	2.5	25
5909-024	16 mm	16.2	27.4	3.5	5
5909-026	20 mm	20.2	33.6	4.0	5



ISO 7093-1

FENDER WASHER					
Part No.	Bolt Dia. (mm)	Inside Dia.	Outside Dia.	Thickness	Pkg Qty
5908-614	6 mm	6.4	18.0	1.6	50
5908-616	8 mm	8.4	24.0	2.0	50
5908-618	10 mm	10.5	30.0	2.5	25
5908-622	12 mm	13.0	37.0	3.0	25

5912
Series



THREADED ROD - 1m		
Part No.	Dia x Length	Qty
5912-308	M4 - 0.7	1
5912-310	M5 - 0.8	1
5912-314	M6 - 1.0	1
5912-316	M8 - 1.25	1
5912-318	M10 - 1.5	1
5912-322	M12 - 1.75	1
5912-324	M16 - 2.0	1
5912-326	M20 - 2.5	1
5912-328	M22 - 2.5	1
5912-330	M24 - 3.0	1

METRIC GARAGE ASSORTMENTS ASSORTIMENTS POUR GARAGE MÉTRIQUE

Most popular **METRIC FASTENERS** packed in divided plastic containers.



020-027 Contains 100 Screws, 6 sizes
Pan, Oval - Phillips Trim

TRIM SCREWS		
Part No.	Size	Qty
230-203	4.2 x 13 mm	15
230-205	4.2 x 20 mm	17
230-207	4.2 x 13 mm	17
230-302	4.2 x 12 mm	17
230-304	4.2 x 16 mm	17
230-305	4.2 x 20 mm	17



020-038 Contains 18 pcs, 6 sizes

INCH & METRIC DRAIN PLUGS		
Part No.	Size	Qty
263-710	1-2 - 20 STD	4
263-911	12 mm x 1.75 STD	3
263-914	14 mm x 1.5 STD	2
263-816	9/16 x 13/16	4
263-815	31/64 x 3/4	3
263-817	5/8 x 15/16	2



020-075 Contains 100 Nuts, 4 sizes
Regular & Washer Types

INCH & METRIC DRAIN PLUGS		
Part No.	Size	Qty
243-004	M4	25
243-005	M5	15
243-105	M5	15
243-106	M6	45



020-077 Contains 100 Retainers, 4 sizes

BOLT RETAINERS		
Part No.	Size	Qty
243-306	M6	20
243-308	M8	35
243-310	M10	35
243-312	M12	10



020-079 Contains 30 Nuts, 5 sizes,
Multi-Thread

"U" NUTS		
Part No.	Size	Qty
241-605	M4 x 0.7	4
241-607	M4 x 1.0 L	6
241-608	M4 x 1.25 L	8
241-609	M8 x 1.25	6
241-610	M8 x 1.5	6



020-125 Contains 82 pcs, 7 sizes

CAP SCREWS		
Part No.	Size	Qty
608-139	M4 x 16	12
608-201	M5 x 16	12
608-203	M5 x 20	15
608-205	M5 x 25	10
608-270	M6 x 16	10
608-274	M6 x 25	15
608-277	M6 x 35	8



020-126 Contains 25 pcs, 7 sizes

CLASS 8.8 CAP SCREWS		
Part No.	Size	Qty
608-314	M8 x 16	6
608-316	M8 x 20	4
608-318	M8 x 25	5
608-231	M8 x 35	2
608-370	M10 x 30	3
608-372	M10 x 40	3
608-374	M10 x 50	2



020-127 Contains 110 pcs, 6 sizes

HEX NUTS		
Part No.	Size	Qty
670-004	M4	20
670-005	M5	20
670-006	M6	25
670-008	M8	25
670-010	M10	15
670-012	M12	5



020-128 Contains 33 pcs, 5 sizes

NYLON COLLAR LOCK NUTS		
Part No.	Size	Qty
700-004	M4	8
700-005	M5	8
700-006	M6	8
700-008	M8	6
700-010	M10	3



020-129 Contains 235 pcs, 5 sizes

FLAT WASHERS		
Part No.	Size	Qty
730-004	4 mm	75
730-005	5 mm	75
730-006	6 mm	50
730-008	8 mm	25
730-010	10 mm	10



020-130 Contains 300 pcs, 5 sizes

LOCK WASHERS		
Part No.	Size	Qty
740-004	4 mm	50
740-005	5 mm	75
740-006	6 mm	75
740-008	8 mm	75
740-010	10 mm	25



020-131 Contains 250 pcs, 5 sizes

SPRING WASHERS		
Part No.	Size	Qty
024-344	4 mm	50
024-345	5 mm	50
024-346	6 mm	50
024-348	8 mm	50
024-350	10 mm	50

METRIC GARAGE ASSORTMENTS ASSORTIMENTS POUR GARAGE MÉTRIQUE

Most popular **METRIC FASTENERS** packed in divided plastic containers.



020-132 Contains 33 pcs, 14 sizes

SOCKET SET SCREWS		
Part No.	Size	Qty
024-904	M4 x 5	3
024-907	M4 x 10	4
024-910	M5 x 10	3
024-913	M5 x 16	4
024-916	M6 x 8	4
024-919	M6 x 12	3
024-922	M6 x 20	1
024-926	M8 x 8	3
024-930	M8 x 12	3
024-934	M8 x 20	1
024-981	2 mm S	1
024-982	2.5 mm S	1
024-983	M3	1
024-984	M4	1



020-133 Contains 210 pcs, 10 sizes

MACHINE SCREWS & NUTS		
Part No.	Size	Qty
771-132	M4 x 6	20
771-136	M4 x 12	15
771-197	M5 x 10	20
771-201	M5 x 16	15
771-266	M6 x 10	10
771-270	M6 x 16	15
771-272	M6 x 20	10
670-004	M4	35
670-005	M5	35
670-006	M6	35



020-134 Contains 275 pcs, 5 sizes

COTTER PINS		
Part No.	Size	Qty
752-006	1.5 x 16	75
752-015	2 x 20	75
752-024	3 x 25	50
752-027	3 x 40	50
752-037	4 x 50	25



020-135 Contains 56 pcs, 7 sizes

SLOTTED SPRING PINS					
Part No.	Size	Qty	Part No.	Size	Qty
024-734	2 x 16	10	024-755	5 x 36	8
024-737	2.5 x 18	10	024-758	5 x 50	5
024-743	3 x 40	10	024-764	6 x 50	5
024-746	4 x 18	8			

UTILITY ASSORTMENTS ASSORTIMENTS UTILITAIRES



020-311 Contains 40 pcs, 8 sizes

WHEEL NUTS		
Part No.	Size	Qty
558-014	7/16-20 R REG	5
558-016	1/2-20 R REG	5
558-027	1/2-20 R REG	5
558-044	5/8-18 R REG	5
558-047	9/16-18 R REG	5
558-100	9/16-18 R REG	5
559-125	M12-1.25 REG	5
559-150	M12-1.5 REG	5

For a complete listing of Metric Wheel Bolts and Nuts see current Wheel Parts Catalogue



020-425 Contains 100 pcs, 10 sizes
Fine & Extra Fine Thread Series

METRIC CAP SCREWS & NUTS		
Part No.	Size	Qty
609-322	M8 x 40	10
610-374	M10 x 50	10
609-374	M10 x 50	10
610-418	M12 x 50	10
609-418	M12 x 50	10
670-208	M8 x 1	10
670-750	M10 x 1	10
670-210	M10 x 1.25	10
670-765	M12 x 1.25	10
670-212	M12 x 1.5	10



020-426 Contains 160 pcs, 13 sizes
COARSE Thread Series

METRIC CAP SCREWS & NUTS		
Part No.	Size	Qty
608-203	M5 x 20	5
608-272	M6 x 20	10
608-276	M6 x 30	10
608-316	M8 x 20	10
608-320	M8 x 30	15
608-322	M8 x 40	10
608-372	M10 x 40	15
608-416	M12 x 40	5
670-005	M5	5
670-006	M6	20
670-008	M8	35
670-010	M10	15
670-012	M12	5

**MASTER ASSORTMENTS
ASSORTIMENTS GÉNÉRAUX**

Most popular **INCH AND METRIC FASTENERS** packed in durable steel merchandisers with illustrated lid labels.



020-728

020-611 Contains 136 pcs, 20 sizes

BUMPER BAR BOLTS		
Part No.	Size	Qty
245-153	5/16-18 x 1	4
245-160	3/8 - 16 x 3/4	6
245-161	3/8 - 16 x 3/4	6
245-164	3/8 - 16 x 1	6
245-165	3/8 - 16 x 1	6
245-167	3/8 - 16 x 1 1/4	6
245-172	7/16 - 14 x 1 1/4	4
245-173	7/16 - 14 x 1 1/2	8
245-175	7/16 - 14 x 2	3
245-182	1/2-13 x 1 1/4	3
245-183	1/2-13 x 1 1/2	3
245-184	1/2-13 x 1 3/4	2
245-220	M8 - 1.25 x 25 mm	6
245-221	M8 - 1.25 x 30 mm	6
700-008	M8	12
117-516	5/16 - 18	4
117-518	3/8 - 16	30
117-520	7/16 - 14	14
117-522	1/2 - 13	8

020-630 Contains 126 pcs, 22 sizes

DRAIN PLUGS & GASKETS		
Part No.	Size	Qty
263-710	1/2-20	6
263-816	9/16	3
263-718	1/2-20	3
263-875	12 mm x 25 mm	11
263-908	M12 - 1.75	3
263-913	M12 - 1.25	6
263-815	31/64 x 3/4	8
263-919	M12 - 1.75	3
263-929	M12 - 1.75	2
263-923	M14 - 1.5	3
263-925	M14 - 1.5	3
263-885	1/2, M12 S.O.	8
263-914	14 mm x 1.5 STD	12
263-870	14 mm x 20 mm	8
263-856	19/32(14 mm)	8
263-917	14 mm x 1.5	3
263-876	9/16 (14 mm)	11
263-912	12 mm x 1.25	6
263-911	12 mm x 1.75 STD	3
263-844	M14, 1/2 T.O.	8
263-817	5/8	5
263-869	12 mm S.O.	3

020-658 Contains 125 pcs, 20 sizes

WHEEL BOLTS & NUTS		
Part No.	Size	Qty
560-103	1/2 - 20R x 1 1/2	5
560-114	7/16 - 20R x 1 1/2	5
560-138	1/2 - 20R x 1 5/8	5
560-148	1/2 - 20R x 1 13/16	5
560-155	1/2 - 20R x 1 5/8	5
560-167	1/2 - 20R x 1 15/16	5
560-172	1/2 - 20R x 1 7/8	5
560-173	1/2 - 20R x 1 3/4	5
560-386	7/16 - 20R x 1 5/16	5
561-108	M12 - 1.5R x 38.5 mm	5
561-109	M12 - 1.5R x 40 mm	5
561-110	M12 - 1.5R x 43 mm	10
561-122	M12 - 1.5R x 36 mm	5
561-154	M12 - 1.5R x 36 mm	5
561-248	M12 - 1.5R x 43 mm	5
561-251	M12 - 1.5R x 51 mm	5
558-014	7/16 - 20 R REG	10
558-016	1/2 - 20 R REG	10
558-027	1/2 - 20 R REG	10
559-150	M12 - 1.5 REG	10

020-661 Contains 350 Screws, 16 sizes

CHROME TRIM SCREWS		
Part No.	Size	Qty
229-806	6 x 3/4	15
229-811	8 x 3/4	40
229-815	8 x 1	40
229-819	8 x 1-1/4	20
229-833	10 x 3/4	30
229-837	10 x 1	30
229-985	8 x 3/4	20
229-986	8 x 1	20
230-203	4.2 x 13 mm	5
230-205	4.2 x 20 mm	5
230-206	4.2 x 20 mm	10
230-207	4.2 x 20 mm	10
230-301	4.2 x 8 mm	30
230-302	4.2 x 12 mm	30
230-304	4.2 x 16 mm	30
230-305	4.2 x 20 mm	15

020-666 Contains 120 pcs, 16 sizes
Standard & Cup Types

EXPANSION PLUGS		
Part No.	Size	Qty
261-024	24 mm	6
261-046	35 mm	10
261-090	52 mm	6
261-105	12 mm	4
261-107	14 mm	4
261-126	25 mm	8
261-138	30 mm	5
261-145	34 mm	12
261-146	35 mm	8
261-161	40 mm	12
261-165	41 mm	16
261-177	45 mm	4
261-181	47 mm	3
261-184	49.5 mm	5
261-185	50 mm	14
261-170	42.3 mm	3

020-669 Contains 241 pcs, 11 sizes

6-LOBE TRIM SCREWS		
Part No.	Size	Qty
231-205	4.2 x 20 mm	40
231-206	4.2 x 20 mm	40
231-209	4.2 x 30 mm	20
231-210	4.2 x 30 mm	20
231-213	4.2 x 40 mm	10
231-219	4.2 x 55 mm	10
231-251	4.2 x 20 mm	35
231-252	4.2 x 20 mm	35
231-257	4.2 x 35 mm	15
231-264	4.2 x 50 mm	15
231-982	T-15	1

020-674 Contains 325 pcs, 26 sizes

'PALNUT' FASTENERS		
Part No.	Size	Qty
242-016	5/16 - 24	13
242-018	3/8 - 24	10
242-108	8 - 32	13
242-110	10 - 24	20
242-114	1/4 - 20	20
242-116	5/16 - 18	10
242-206	1/8	8
242-208	5/32	8
242-210	3/16	15
242-214	1/4	13
242-216	5/16	10
242-314	1/4	15
242-316	5/16	15
242-318	3/8	15
242-406	1/8	10
242-408	5/32	10
242-410	3/16	15
242-413	.240	10
243-004	M4	10
243-106	M6	13
243-204	4 mm	13
243-306	M6	13
243-308	M8	13
243-310	M10	10
243-404	M4	13
243-405	M5	10

MASTER ASSORTMENTS ASSORTIMENTS GÉNÉRAUX

Most popular **METRIC FASTENERS** packed in durable steel merchandisers with illustrated lid labels.

020-685 Contains 160 pcs, 16 sizes
Inch & Metric Fittings

GREASE FITTINGS		
Part No.	Size	Qty
904-610	1/8 STR	10
904-688	1/8 45	10
904-612	1/8 65	10
904-613	1/8 90	10
904-641	1/4 - 28 STR	10
904-652	1/4 - 28 STR L	10
904-636	1/4 - 28 45S	10
904-691	1/4 - 28 90	10
904-701	6 mm x 1 STR	10
904-745	6 mm x 1 45	10
904-790	6 mm x 1 90	10
904-702	8 mm x 1 STR	10
904-746	8 mm x 1 45	10
904-791	8 mm x 1 90	10
904-703	10 mm x 1 STR	10
904-747	10 mm	5
904-792	10 mm THREAD	5

020-692 Contains 100 pcs, 20 sizes

BUMPER BAR BOLTS		
Part No.	Size	Qty
240-614	1/4 - 20	5
240-615	1/4 - 20	5
240-616	5/16 - 18	10
240-617	5/18 - 18	5
240-618	3/8 - 16	5
240-619	3/8 - 16	10
240-706	#6	2
240-708	#8	2
240-709	#8	3
240-710	#10	3
240-714	#14	3
240-715	#14	2
241-604	M4 x .7	2
241-605	M4 x .7	3
241-606	M6 x 1.0	5
241-607	M6 x 1.0	5
241-608	M8 x 1.25	10
241-609	M8 x 1.25	10
241-610	M10 x 1.5	5
241-612	M6.3 x 1.0	5

020-693 Contains 120 pcs, 20 sizes

'PLASTI-RIVETS'		
Part No.	Size	Qty
247-300	5 mm x 6 mm	10
247-301	6.3 mm x 10 mm	10
247-302	6.3 mm x 6 mm	10
247-303	6.3 mm x 10 mm	10
247-304	6.6 mm x 5 mm	10
247-305	6.6 mm x 5 mm	10
247-306	5 mm x 4.5 mm	10
247-307	5 mm x 10 mm	10
247-401	GM	5
247-402	GM	5
247-403	GM	5
247-405	GM	5
247-406	GM, FORD	5
247-407	GM	5
247-411	GM	5
247-462	FORD	10
247-464	FORD	5
247-466	FORD	10
247-467	FORD	5
247-468	FORD	5

020-695 Contains 190 pcs, 20 sizes

10.9 FLANGE HEX BOLT IFI STD ZINC		
Part No.	Size	Qty
611-270	M6 x 1.0 x 16	10
611-274	M6 x 1.0 x 25	10
611-276	M6 x 1.0 x 30	10
611-278	M6 x 1.0 x 40	10
611-316	M8 x 1.25 x 20	10
611-318	M8 x 1.25 x 25	10
611-322	M8 x 1.25 x 40	5
611-324	M8 x 1.25 x 50	5
611-326	M8 x 1.25 x 60	5
611-366	M10 x 1.25 x 20	5
611-368	M10 x 1.25 x 25	5
611-370	M10 x 1.25 x 30	5
611-371	M10 x 1.25 x 35	5
611-372	M10 x 1.25 x 40	5
611-373	M10 x 1.25 x 45	5
611-374	M10 x 1.25 x 50	5
611-376	M10 x 1.25 x 60	5
244-986	M6 x 1.0	25
244-987	M8 x 1.25	25
244-998	M10 x 1.25	25

020-725 Contains 562 pcs, 18 sizes

CAP SCREWS & NUTS		
Part No.	Size	Qty
608-139	M4 x 16	25
608-198	M5 x 12	25
608-201	M5 x 16	30
608-203	M5 x 20	30
608-205	M5 x 25	25
608-267	M6 x 12	20
608-270	M6 x 16	25
608-272	M6 x 20	25
608-274	M6 x 25	25
608-276	M6 x 30	15
608-277	M6 x 35	5
608-279	M6 x 45	5
670-004	M4	25
670-005	M5	110
670-006	M6	112
700-004	M4	20
700-005	M5	20
700-006	M6	20

020-726 Contains 186 pcs, 18 sizes

CAP SCREWS & NUTS		
Part No.	Size	Qty
608-311	M8 x 12	8
608-314	M8 x 16	9
608-316	M8 x 20	10
608-318	M8 x 25	10
608-320	M8 x 30	8
608-322	M8 x 40	6
608-324	M8 x 50	4
608-326	M8 x 60	3
608-328	M8 x 70	3
608-370	M10 x 30	6
608-372	M10 x 40	6
608-374	M10 x 50	4
608-376	M10 x 60	3
608-378	M10 x 70	3
670-008	M8	61
670-010	M10	22
700-008	M8	10
700-010	M10	10

020-727 Contains 1000 pcs, 15 sizes

FLAT, SPRING & LOCK WASHERS		
Part No.	Size	Qty
730-004	4 mm	100
730-005	5 mm	100
730-006	6 mm	100
730-008	8 mm	75
730-010	10 mm	50
740-004	4 mm	100
740-005	5 mm	100
740-006	6 mm	125
740-008	8 mm	75
740-010	10 mm	50
024-324	M4	25
024-325	M5	25
024-326	M6	25
024-328	M8	25
024-330	M10	25

020-728 Contains 384 pcs, 24 sizes

SOCKET SET SCREWS & KEYS		
Part No.	Size	Qty
024-981	M2	1
024-982	M2.5	1
024-983	M3	1
024-984	M4	1
024-204	M4	40
024-205	M5	40
024-206	M6	60
024-406	M4 x 6	20
024-412	M4 x 12	20
024-420	M5 x 10	20
024-426	M5 x 16	20
024-430	M6 x 10	20
024-436	M6 x 16	20
024-440	M6 x 20	20
024-904	M4 x 5	10
024-907	M4 x 10	10
024-910	M5 x 10	10
024-913	M5 x 16	10
024-916	M6 x 8	10
024-919	M6 x 12	10
024-922	M6 x 20	10
024-926	M8 x 8	10
024-930	M8 x 12	10
024-934	M8 x 20	10

**MASTER ASSORTMENTS
ASSORTIMENTS GÉNÉRAUX**

Most popular **METRIC FASTENERS** packed in durable steel merchandisers with illustrated lid labels.



020-729 Contains 835 pcs, 16 sizes

COTTER PINS & SLOTTED SPRING PINS		
Part No.	Size	Qty
024-704	M1.5 x 16 CP	150
024-707	M2 x 20 CP	200
024-710	M3 x 25 CP	100
024-713	M3 x 40 CP	150
024-716	M4 x 50 CP	75
024-734	M2 x 16 SP	20
024-737	M2.5 x 18 SP	20
024-740	M3 x 24 SP	20
024-743	M3 x 40 SP	15
024-746	M4 x 18 SP	20
024-749	M4 x 36 SP	15
024-752	M4 x 50 SP	10
024-755	M5 x 36 SP	15
024-758	M5 x 50 SP	10
024-761	M6 x 22 SP	10
024-764	M6 x 50 SP	5

020-730 Contains 130 pcs, 20 sizes

CAP SCREWS & NUTS (FINE & EXTRA FINE THREAD)		
Part No.	Size	Qty
610-366	M10 x 1.0 x 20 mm	4
610-368	M10 x 1.0 x 25 mm	4
610-372	M10 x 1.0 x 40 mm	4
610-374	M10 x 1.0 x 50 mm	4
610-414	M12 x 1.25 x 30 mm	3
610-416	M12 x 1.25 x 40	3
610-418	M12 x 1.25 x 50 mm	3
670-750	M10 x 1	16
670-765	M12 x 1.25	9
609-320	M8 x 1.0 x 30 mm	5
609-324	M8 x 1.0 x 50 mm	5
609-368	M10 x 1.25 x 25 mm	5
609-370	M10 x 1.25 x 30 mm	5
609-372	M10 x 1.25 x 40 mm	5
609-374	M10 x 1.25 x 50 mm	5
609-416	M12 x 1.5 x 40 mm	5
609-418	M12 x 1.5 x 50 mm	5
670-208	M8 x 1	10
670-210	M10 x 1.25	20
670-212	M12 x 1.5	10

**STAX-SIX CABINET
CABINET STAX-SIX**



The modern method of stocking Master Assortments.
Each steel STAX-SIX Cabinet holds six Master Assortments in its own rigid drawer slide.



Assortments not included

STAX-SIX – No. 022-091

- Heavy gauge steel construction.
- Baked black enamel finish.
- Rigid drawer slide.
- No-spill feature.
- Size: 15-1/4" W
x 15-1/2" H
x 11-3/4" D

**METRIC MERCHANDISERS
PRÉSENTOIRS MÉTRIQUE**

HANDY-PAKS[®]

- Sturdy, heavy gauge, reinforced steel cabinet
- Use on work bench or hang on wall
- Colourful - Durable - Efficient
- Includes handy bolt measuring gauge



022-065

14-3/4" H x 18-1/2" W

**METRIC FINE THREAD
MERCHANDISER**

022-062

35 sizes of Metric Fine and Extra Fine Cap Screws, Nuts and Lock Washers.

Contains 436 pcs

CAP SCREWS - FINE		
Part No.	Size	Qty
024-120	M8 x 20	7
024-122	M8 x 30	7
024-124	M8 x 40	6
024-126	M8 x 50	5
024-130	M10 x 20	4
024-131	M10 x 25	3
024-132	M10 x 30	3
024-134	M10 x 40	3
024-136	M10 x 50	3
024-138	M10 x 60	2
024-144	M12 x 30	3
024-146	M12 x 40	2
024-148	M12 x 50	2
CAP SCREWS - EXTRA FINE		
Part No.	Size	Qty
024-170	M10 x 20	4
024-171	M10 x 25	3
024-172	M10 x 30	3
024-174	M10 x 40	3
024-176	M10 x 50	3
024-184	M12 x 30	2
024-186	M12 x 40	2
024-188	M12 x 50	2
HEX NUTS - FINE		
Part No.	Size	Qty
024-258	M8 x 1.00	16
024-260	M10 x 1.25	12
024-262	M12 x 1.5	7
HEX NUTS - FINE		
Part No.	Size	Qty
024-270	M10 x 1.00	10
024-272	M12 x 1.25	7
CAP SCREWS - EXTRA FINE		
Part No.	Size	Qty
024-324	4 mm	80
024-325	5 mm	80
024-326	6 mm	60
024-328	8 mm	40
024-330	10 mm	32
024-332	12 mm	20

**METRIC ISO COARSE
THREAD MERCHANDISER**

022-065

35 best sizes of Metric Coarse Thread Cap Screws, Nuts and Washers.

Contains 567 pcs

CAP SCREWS - ISO COARSE		
Part No.	Size	Qty
024-002	M4 x 16	16
024-013	M5 x 16	19
024-014	M5 x 20	17
024-015	M5 x 25	16
024-023	M6 x 12	21
024-024	M6 x 16	18
024-025	M6 x 20	17
024-026	M6 x 25	15
024-027	M6 x 30	13
024-030	M6 x 45	9
024-045	M8 x 12	9
024-046	M8 x 16	9
024-047	M8 x 20	9
024-048	M8 x 25	9
024-049	M8 x 30	8
024-051	M8 x 40	6
024-053	M8 x 50	5
024-055	M8 x 60	4
024-057	M8 x 70	3
024-062	M10 x 30	4
024-064	M10 x 40	4
024-066	M10 x 50	3
024-068	M10 x 60	3
024-070	M10 x 70	3
FLAT WASHERS		
Part No.	Size	Qty
024-304	4 mm	60
024-305	5 mm	56
024-306	6 mm	45
024-308	8 mm	18
024-310	10 mm	14
HEX NUTS - COARSE		
Part No.	Size	Qty
024-204	M4	33
024-205	M5	33
024-206	M6	33
024-208	M8	18
024-210	M10	11
024-212	M12	6

**PLATED METRIC FASTENERS
MERCHANDISER**

022-066

35 sizes of Metric Machine Screws, Lock Washers and Nuts, Spring Washers, Cotter Pins and Socket Screws.

Contains 1282 pcs

MACHINE SCREWS		
Part No.	Size	Qty
024-406	M4 x 6	81
024-412	M4 x 12	72
024-420	M5 x 10	54
024-426	M5 x 16	45
024-436	M6 x 16	80
024-440	M6 x 20	27
LOCK NUTS		
Part No.	Size	Qty
024-224	M4	10
024-225	M5	9
024-226	M6	9
024-228	M8	6
024-230	M10	5
LOCK WASHERS		
Part No.	Size	Qty
024-324	4 mm	80
024-325	5 mm	80
024-326	6 mm	60
024-328	8 mm	40
024-330	10 mm	32
SPRING WASHERS		
Part No.	Size	Qty
024-344	4 mm	99
024-345	5 mm	77
024-346	6 mm	63
024-348	8 mm	54
024-350	10 mm	32
COTTER PINS		
Part No.	Size	Qty
024-704	1.5 x 16	80
024-707	2 x 20	36
024-713	3 x 40	35
024-716	4 x 50	16
SOCKET SCREWS		
Part No.	Size	Qty
024-907	M4 x 10	6
024-910	M5 x 10	6
024-916	M6 x 8	5
024-919	M6 x 12	5
024-930	M8 x 12	3
SPRING PINS		
Part No.	Size	Qty
024-734	2 x 16	27
024-740	3 x 24	20
024-749	4 x 36	14
024-758	5 x 50	8
024-764	6 x 50	6



68" H x 32" W x 15" D

No. 022-068

Assortment contains 110 of our most popular 8.8 Metric Cap Screws, Coarse, Fine and Extra Fine Thread, Cotter Pins and Machine Screws.

Note: Metric Handy-Paks[®] contents are based on Dealer prices currently in effect and are subject to change.

CAP SCREWS - ISO COARSE							
Part No.	Size	Pcs/Pack	Packs	Part No.	Size	Pcs/Pack	Packs
024-002	M4 x 16	16	2	024-050	M8 x 35	7	4
024-004	M4 x 25	11	2	024-051	M8 x 40	6	4
024-012	M5 x 12	25	2	024-052	M8 x 45	5	2
024-013	M5 x 16	19	2	024-053	M8 x 50	5	4
024-014	M5 x 20	17	2	024-055	M8 x 60	4	2
024-015	M5 x 25	16	2	024-057	M8 x 70	3	2
024-023	M6 x 12	21	2	024-060	M10 x 20	5	4
024-024	M6 x 16	18	4	024-061	M10 x 25	4	8
024-025	M6 x 20	17	8	024-062	M10 x 30	4	8
024-026	M6 x 25	15	8	024-063	M10 x 35	4	4
024-027	M6 x 30	13	4	024-064	M10 x 40	4	4
024-028	M6 x 35	10	4	024-066	M10 x 50	3	4
024-029	M6 x 40	10	4	024-068	M10 x 60	3	2
024-030	M6 x 45	9	2	024-070	M10 x 70	3	2
024-031	M6 x 50	9	2	024-075	M12 x 30	3	3
024-045	M8 x 12	9	2	024-077	M12 x 40	3	3
024-046	M8 x 16	9	4	024-079	M12 x 50	3	3
024-047	M8 x 20	9	8	024-081	M12 x 60	2	2
024-048	M8 x 25	9	8	024-083	M12 x 70	2	2
024-049	M8 x 30	8	4				
CAP SCREWS - FINE							
024-120	M8 x 20	7	2	024-133	M10 x 35	4	2
024-122	M8 x 30	7	2	024-134	M10 x 40	3	2
024-124	M8 x 40	6	2	024-136	M10 x 50	3	2
024-126	M8 x 50	5	2	024-138	M10 x 60	2	2
024-130	M10 x 20	4	2	024-144	M12 x 30	3	2
024-131	M10 x 25	3	2	024-146	M12 x 40	2	2
024-132	M10 x 30	3	2	024-148	M12 x 50	2	2

CAP SCREWS - ISO COARSE			
Part No.	Size	Pcs/Pack	Packs
024-170	M10 x 20	4	2
024-171	M10 x 25	3	2
024-172	M10 x 30	3	2
024-174	M10 x 40	3	2
024-176	M10 x 50	3	2
024-184	M12 x 30	2	2
024-186	M12 x 40	2	2
024-188	M12 x 50	2	2
MACHINE SCREWS			
024-430	M6 x 10	30	2
024-436	M6 x 16	80	2
024-440	M6 x 20	27	2
HEX NUTS - FINE			
024-258	M8 x 1.00	16	2
024-260	M10 x 1.25	12	2
024-262	M12 x 1.5	7	2
HEX NUTS - EXTRA FINE			
024-270	M10 x 1.00	10	2
024-272	M12 x 1.25	7	2
HEX NUTS - ISO COARSE			
024-204	M4	33	3
024-205	M5	33	3
024-206	M6	33	8
024-208	M8	18	8
024-210	M10	11	7
024-212	M12	6	3
LOCK NUTS			
024-224	M4	10	2
024-226	M6	9	2
024-228	M8	6	2
024-230	M10	5	2
FLAT WASHERS			
024-304	4 mm	60	3
024-305	5 mm	56	3
024-306	6 mm	45	6
024-308	8 mm	18	6
024-310	10 mm	14	6
024-312	12 mm	12	3
LOCK WASHERS			
024-324	4 mm	80	3
024-325	5 mm	80	3
024-326	6 mm	60	6
024-328	8 mm	40	6
024-330	10 mm	32	6
024-332	12 mm	20	3

METRIC HANDY-PAKS® HANDY-PAKS® MÉTRIQUE

CLASS 8.8 COARSE HEX HEAD CAP SCREWS					
Handy-Pak® No.	Size	Handy-Pak® No.	Size	Handy-Pak® No.	Size
024-002	M4 x 16*	024-031	M6 x 50	024-062	M10 x 30*
024-004	M4 x 25	024-045	M8 x 12*	024-063	M10 x 35*
024-012	M5 x 12*	024-046	M8 x 16*	024-064	M10 x 40
024-013	M5 x 16*	024-047	M8 x 20*	024-066	M10 x 50
024-014	M5 x 20*	024-048	M8 x 25*	024-068	M10 x 60
024-015	M5 x 25*	024-049	M8 x 30*	024-070	M10 x 70
024-023	M6 x 12*	024-050	M8 x 35	024-075	M12 x 30*
024-024	M6 x 16*	024-051	M8 x 40	024-077	M12 x 40*
024-025	M6 x 20*	024-052	M8 x 45	024-079	M12 x 50
024-026	M6 x 25*	024-053	M8 x 50	024-081	M12 x 60
024-027	M6 x 30	024-055	M8 x 60	024-083	M12 x 70
024-028	M6 x 35	024-057	M8 x 70		
024-029	M6 x 40	024-060	M10 x 20*		
024-030	M6 x 45	024-061	M10 x 25*		

Thread Length:
Formula is 2D + 6 mm.
Items marked * are fully threaded.

CLASS 8.8 FINE THREAD HEX HEAD CAP SCREWS			
Handy-Pak® No.	Size	Handy-Pak® No.	Size
024-120	M8 x 1.0 x 20*	024-133	M10 x 1.25 x 35*
024-122	M8 x 1.0 x 30*	024-134	M10 x 1.25 x 40*
024-124	M8 x 1.0 x 40*	024-136	M10 x 1.25 x 50*
024-126	M8 x 1.0 x 50*	024-138	M10 x 1.25 x 60
024-130	M10 x 1.25 x 20*	024-144	M12 x 1.5 x 30*
024-131	M10 x 1.25 x 25*	024-146	M12 x 1.5 x 40*
024-132	M10 x 1.25 x 30*	024-148	M12 x 1.5 x 50*

CLASS 8.8 EXTRA FINE THREAD HEX HEAD CAP SCREWS			
Handy-Pak® No.	Size	Handy-Pak® No.	Size
024-170	M10 x 1.0 x 20*	024-176	M10 x 1.0 x 50*
024-171	M10 x 1.0 x 25*	024-184	M12 x 1.25 x 30*
024-172	M10 x 1.0 x 30*	024-186	M12 x 1.25 x 40*
024-174	M10 x 1.0 x 40*	024-188	M12 x 1.25 x 50*

CLASS 8 COARSE HEX NUTS					
Handy-Pak® No.	Size	Handy-Pak® No.	Size	Handy-Pak® No.	Size
024-204	M4	024-206	M6	024-210	M10
024-205	M5	024-208	M8	024-212	M12

NYLON COLLAR STOP NUTS 'POZI-LOK®' NUTS					
Handy-Pak® No.	Size	Handy-Pak® No.	Size	Handy-Pak® No.	Size
024-224	M4	024-226	M6	024-230	M10
024-225	M5	024-228	M8		

CLASS 8 FINE AND EXTRA FINE THREAD HEX NUTS			
Handy-Pak® No.	Size	Handy-Pak® No.	Size
024-258	M8 x 1.0	024-270	M10 x 1.0
024-260	M10 x 1.25	024-272	M12 x 1.25
024-262	M12 x 1.5		

FLAT WASHERS					
Handy-Pak® No.	Size	Handy-Pak® No.	Size	Handy-Pak® No.	Size
024-304	4 mm	024-306	6 mm	024-310	10 mm
024-305	5 mm	024-308	8 mm	024-312	12 mm

LOCK WASHERS					
Handy-Pak® No.	Size	Handy-Pak® No.	Size	Handy-Pak® No.	Size
024-324	4 mm	024-326	6 mm	024-330	10 mm
024-325	5 mm	024-328	8 mm	024-332	12 mm

SPRING (WAVE TYPE) WASHERS (PLAIN FINISH)			
Handy-Pak® No.	Size	Handy-Pak® No.	Size
024-344	4 mm	024-348	8 mm
024-345	5 mm	024-350	10 mm
024-346	6 mm		

MACHINE SCREWS PAN PHILLIPS HEAD			
Handy-Pak® No.	Size	Handy-Pak® No.	Size
024-398	M3-0.5 x 6	024-421	M5-0.8 x 12
024-399	M3-0.5 x 10	024-422	M5-0.8 x 20
024-400	M3-0.5 x 16	024-423	M5-0.8 x 25
024-401	M3-0.5 x 20	024-424	M5-0.8 x 30
024-402	M3-0.5 x 25	024-425	M5-0.8 x 35
024-403	M3-0.5 x 30	024-426	M5-0.8 x 16
024-404	M3-0.5 x 35	024-427	M5-0.8 x 40
024-405	M3-0.5 x 50	024-428	M5-0.8 x 50
024-406	M4-0.7 x 6	024-429	M6-1.0 x 8
024-407	M4-0.7 x 10	024-430	M6-1.0 x 10
024-410	M4-0.7 x 16	024-432	M6-1.0 x 12
024-411	M4-0.7 x 20	024-436	M6-1.0 x 16
024-412	M4-0.7 x 12	024-440	M6-1.0 x 20
024-413	M4-0.7 x 25	024-441	M6-1.0 x 25
024-414	M4-0.7 x 30	024-442	M6-1.0 x 30
024-415	M4-0.7 x 35	024-443	M6-1.0 x 35
024-416	M4-0.7 x 40	024-444	M6-1.0 x 40
024-417	M4-0.7 x 50	024-446	M6-1.0 x 50
024-418	M4-0.7 x 60	024-448	M8-1.25 x 12
024-419	M5-0.8 x 6	024-451	M8-1.25 x 30
024-420	M5-0.8 x 10	024-453	M8-1.25 x 40

COTTER PINS			
Handy-Pak® No.	Size	Handy-Pak® No.	Size
024-704	M1.5 x 16	024-713	M3 x 40
024-707	M2.0 x 20	024-716	M4 x 50
024-710	M3 x 25		

SLOTTED SPRING PINS (PLAIN FINISH)			
Handy-Pak® No.	Size	Handy-Pak® No.	Size
024-734	M2.0 x 16	024-752	M4 x 50
024-737	M2.5 x 18	024-755	M5 x 36
024-740	M3.0 x 24	024-758	M5 x 50
024-743	M3.0 x 40	024-761	M6 x 22
024-746	M4 x 18	024-764	M6 x 50
024-749	M4 x 36		

SOCKET SCREWS KEYS (PLAIN FINISH)					
Handy-Pak® No.	Size	Handy-Pak® No.	Size	Handy-Pak® No.	Size
024-904	M4 x 5	024-916	M6 x 8	024-926	M8 x 8
024-907	M4 x 10	024-919	M6 x 12	024-930	M8 x 12
024-910	M5 x 10	024-922	M6 x 20	024-934	M8 x 20
024-913	M5 x 16				

MACHINE SCREWS PAN SLOT HEAD					
Handy-Pak® No.	Size	Handy-Pak® No.	Size	Handy-Pak® No.	Size
024-406	M4 x 6	024-420	M5 x 10	024-430	M6 x 10
024-412	M4 x 12	024-426	M5 x 16	024-436	M6 x 16
				024-440	M6 x 20

SOCKET SCREWS KEYS (PLAIN FINISH)					
Handy-Pak® No.	Size	Handy-Pak® No.	Size	Handy-Pak® No.	Size
024-980	1.5 mm	024-983	3 mm	024-986	6 mm
024-981	2.0 mm	024-984	4 mm	024-988	8 mm
024-982	2.5 mm	024-985	5 mm		



STANDARD FASTENERS

ATTACHES STANDARD

HEX HEAD CAP SCREWS

- GRADE 2
- GRADE 5
- GRADE 8

HEX NUTS

- GRADE 2
- GRADE 5
- GRADE 8

'CONELOK' LOCKNUTS

HEAVY HEX NUTS

- LOCK WASHERS (EXTRA DUTY)**
- TENSION WASHERS**
- DOUBLE THICKNESS NUTS**
- WING NUTS**
- ACORN (CAP) NUTS**
- PANEL NUTS**
- POZI-LOK® STOP NUTS PLATED**

POZI-LOK® DOUBLE NUT

- FLANGE NUTS**
- KEPS® LOCKNUT**
- ELEVATOR BOLTS**
- CARRIAGE BOLTS**
- PLOW BOLTS**
- HEX LAG BOLTS & SHIELDS**
- SQUARE HEAD SET SCREWS**

GRADE 5 HEX HEAD CAP SCREWS BARE BOULONS HEX CLASSE 5 NUS

073
UNC
Coarse

074
UNF
Fine

- Made to S.A.E. J429 specifications.
- Medium carbon Steel.
- Double heat treated.
- Bare Metal.



Papco® Grade 5 Cap Screws, identified by the three radial bar head marking, are made of medium carbon steel, quenched and tempered for higher tensile strength and holding power. Tensile strength: up to 1" Dia.-120,000 p.s.i. (min.) 1-1/8" Dia. up-105,000 p.s.i. (min.)

ORDER BY STOCK NUMBER

Example of Stock No. 073-586 is 1/2 x 2 Coarse Thread Grade 5 Cap Screw Bare Metal.

UNC Coarse Thread, add prefix 073

UNF fine thread, add prefix 074

Threads per inch	UNC	20	18	16	14	13	12	11	10	9	8	7	7	6	
	UNF	28	24	24	20	20	18	18	16	14	14	12	12	12	
Diameter	1/4	5/16	3/8	7/16	1/2	9/16	5/8	3/4	7/8	1	1-1/8	1-1/4	1-1/2		
1/2	-305	-440	-485	-	-	-	-	-	-	-	-	-	-	-	
3/4	-307	-442	-487	-532	-	-	-	-	-	-	-	-	-	-	
1	-309	-444	-489	-534	-579	-623	-668	-	-	-	-	-	-	-	
1-1/4	-311	-446	-491	-536	-581	-625	-670	-	-	-	-	-	-	-	
1-1/2	-313	-448	-493	-538	-583	-627	-672	-714	-	-	-	-	-	-	
1-3/4	-315	-450	-495	-540	-585	-629	-674	-716	-761	-802	-	-	-	-	
2	-316	-451	-496	-541	-586	-630	-675	-717	-762	-803	-	-	-	-	
2-1/4	-317	-452	-497	-542	-587	-631	-676	-718	-763	-804	-	-	-	-	
2-1/2	-318	-453	-498	-543	-588	-632	-677	-719	-764	-805	-845	-885	-	-	
2-3/4	-319	-454	-499	-544	-589	-633	-678	-720	-765	-806	-846	-886	-	-	
3	-320	-455	-500	-545	-590	-634	-679	-721	-766	-807	-847	-887	-	-	
3-1/2	-322	-457	-502	-547	-592	-636	-681	-723	-768	-809*	-849	-889	-	-	
4	-324	-459	-504	-549	-594	-638	-683	-725	-770	-811*	-851	-891	-961	-	
4-1/2	-325	-460	-505	-550	-595	-639	-684	-726	-771	-812*	-852	-892	-962	-	
5	-326	-461	-506*	-551	-596	-640	-685	-727	-772	-813*	-853	-893	-963	-	
5-1/2	-327	-462	-507*	-552	-597	-641	-686	-728	-773*	-814*	-854	-894	-964	-	
6	-329	-464	-509*	-554	-599*	-643	-688	-730	-775*	-816*	-856	-896	-966	-	
7	-	-	-	-	-601*	-	-690	-732	-777*	-818*	-858	-898	-968	-	
8	-	-	-	-	-603*	-	-692	-734	-779*	-820*	-860	-900	-970	-	
Head Width Across Flats	7/16	1/2	9/16	5/8	3/4	13/16	15/16	1-1/8	1-5/16	1-1/2	1-11/16	1-7/8	2-1/4		
Head Height	5/32	13/64	15/64	9/32	5/16	23/64	25/64	15/32	35/64	39/64	11/16	25/32	15/16		
Standard Package	100	100	100	50*	50	50	25*	25	25	20	20	10*	20	10*	As Required

GRADE 5 HEX NUTS BARE ÉCROUS HEX CLASSE 5 NUS

085
UNC
Coarse

086
UNF
Fine

- Made to Standard Finished Hexagon Nut dimensions.
- Bare Metal.



Stock No.	Diameter	1/4	5/16	3/8	7/16	1/2	9/16	5/8	3/4	7/8	1
		UNC Coarse	085-014	085-016	085-018	085-020	085-022	085-023	085-024	085-026	085-028
	UNF Fine	086-014	086-016	086-018	086-020	086-022	086-023	086-024	086-026	086-028	086-030
	Standard Package	100	100	100	50	50	25	25	20	20	20

For Grade 2 Plated and Bare Hex Nuts see page 63.

GRADE 2 HEX HEAD CAP SCREWS PLATED BOULONS HEX CLASSE 2 PLAQUÉS

071
UNC
Plated

Papco® Grade 2 Cap Screws are made from low carbon steel and have no head bar markings. Tensile strength: up to 5/8" Dia.-64,000 p.s.i. (min.) 3/4" Dia. up-55,000 p.s.i. (min.)



ORDER BY STOCK NUMBER

UNC Coarse Thread Zinc Plated, add prefix 071.

Example of Stock No. 071-586 is 1/2 x 2 Coarse Thread Grade 2 Cap Screw Zinc Plated.

NOTE: BOLT STRENGTH IS INDICATED BY HEAD MARKING. DO NOT REPLACE WITH A LOWER GRADE THAN THE ORIGINAL.

PLATED GRADE 5 HEX HEAD CAP SCREWS BOULONS HEX CLASSE 5 PLAQUÉS

075
UNC
Coarse

076
UNF
Fine

- Made to S.A.E. J429 specifications.
- Medium carbon Steel.
- Double heat treated.
- Bright Electroplated with Chromate Finish.



Papco® Plated Grade 5 Cap Screws are identified by the three radial bar head marking and are made of medium carbon steel, quenched and tempered for higher Tensile strength and holding power. Bright Electroplated with Chromate finish to resist rust. Tensile strength: up to 1" Dia.-120,000 p.s.i. (min.) 1-1/8" Dia. up-105,000 p.s.i. (min.)

ORDER BY STOCK NUMBER

Example of Stock No. 075-586 is 1/2 x 2 Coarse Thread Plated Grade 5 Cap Screw.

UNC Coarse Thread Plated, add prefix 075

UNF Fine Thread Plated, add prefix 076

Threads per inch	UNC	20	18	16	14	13	12	11	10	9	8	7
	UNF	28	24	24	20	20	18	18	16	14	14	12
Diameter	1/4	5/16	3/8	7/16	1/2	9/16	5/8	3/4	7/8	1	1-1/4	
1/2	-305	-440	-	-	-	-	-	-	-	-	-	-
3/4	-307	-442	-487	-532	-	-	-	-	-	-	-	-
1	-309	-444	-489	-534	-579	-623	-668	-	-	-	-	-
1-1/4	-311	-446	-491	-536	-581	-625	-670	-	-	-	-	-
1-1/2	-313	-448	-493	-538	-583	-627	-672	-714	-	-	-	-
1-3/4	-315	-450	-495	-540	-585	-	-674	-716	-761	-802	-	-
2	-316	-451	-496	-541	-586	-630	-675	-717	-762	-803	-	-
2-1/4	-317	-452	-497	-	-587	-	-676	-718	-763	-804	-	-
2-1/2	-318	-453	-498	-543	-588	-632	-677	-719	-764	-805	-885	-
3	-320	-455	-500	-545	-590	-634	-679	-721	-766	-807	-887	-
3-1/2	-322	-457	-502	-547	-592	-	-681	-723	-768	-809*	-889	-
4	-324	-459	-504	-549	-594	-	-683	-725	-770	-811*	-891	-
4-1/2	-325	-460	-505	-	-595	-	-684	-726	-771	-812*	-892	-
5	-326	-461	-506*	-	-596	-	-685	-727	-772	-813*	-893	-
5-1/2	-	-	-	-	-597	-	-686	-728	-773*	-814*	-894	-
6	-	-	-509*	-554	-599*	-	-688	-730	-775*	-816*	-896	-
Head Width Across Flats	7/16	1/2	9/16	5/8	3/4	13/16	15/16	1-1/8	1-5/16	1-1/2	1-7/8	
Head Height	5/32	13/64	15/64	9/32	5/16	23/64	25/64	15/32	35/64	39/64	25/32	
Standard Package	100	100	100 50*	50	20 25*	25	25	20	20 10*	20 10*	As Required	

PLATED GRADE 5 HEX NUTS ÉCROUS HEX CLASSE 5 PLAQUÉS

087
UNC
Coarse

088
UNF
Fine

- Made to Standard Finished Hexagon Nut dimensions.
- Bright Electroplated with Chromate Finish.



Stock No.	Diameter	1/4	5/16	3/8	7/16	1/2	9/16	5/8	3/4	7/8	1
		UNC Coarse	087-014	087-016	087-018	087-020	087-022	087-023	087-024	087-026	087-028
	UNF Fine	088-014	088-016	088-018	088-020	088-022	088-023	088-024	088-026	088-028	088-030
	Standard Package	100	100	100	50	50	25	25	20	20	20

PLATED BULK FASTENERS ATTACHES EN VRAC PLAQUÉS

- 1/8 keg - 25 lbs. (maximum).
- Bright Electroplated with chromate finish.

Papco® Plated Grade 5 Cap Screws, Hex Nuts, Washers, Carriage Bolts, Lag Bolts and Screw Products series No. 845.

Refer to the current jobber or dealer price books for bulk quantities and sizes.



CAP SCREWS AND NUT UTILITY ASSORTMENTS ASSORTIMENTS UTILITAIRES DE BOULONS HEX ET ÉCROUS

Plated Grade 5 Cap Screws and Nuts. Dimensions and retail codes shown on lid.

No. 020-326

Contains 105 Fine Thread Screws in sizes from 1/4" x 3/4" to 1/2" x 1"-1/2".



No. 020-327

Contains 105 Coarse Thread Screws in sizes from 1/4" x 3/4" to 1/2" x 1-1/2".



No. 020-347

Contains 133 Hexagon Nuts in Fine, and Coarse sizes from 1/4" to 1/2" Dia.



CAP SCREWS AND NUT MASTER ASSORTMENTS ASSORTIMENTS GÉNÉRAUX DE BOULONS HEX ET ÉCROUS



Packed in metal, sectional divided box with moulded plastic compartments. The hinged, safety-lock lid may be closed and carried to the job. Contains the most popular sizes of Plated Grade 5 Cap Screws.

No. 020-622

Contains 20 best sizes of Plated Grade 5 Screws, Nuts, Washers, Stove Bolts and Cotter Pins.
UNC Cap Screws — 1/4" x 3/4" ; 1/4" x 1" ; 5/16" x 3/4" ; 5/16" x 1" ; 3/8" x 1" ; 3/8" x 1-1/2".
UNC Nuts — 1/4"; 5/16"; 3/8". **Lock Washers** — 1/4"; 5/16"; 3/8".
S.A.E Washers — 1/4"; 5/16"; 3/8". **Cotter Pins** — 3/32" x 1"; 1/8" x 2".
Stove Bolts — 3/16" x 1"; 1/4" x 3/4"; 1/4" x 1".

Have all the MOST USED sizes of Fasteners available when you need them.

No. 020-646

Contains 208 Plated Grade 5, UNF Fine Thread Cap Screws — 20 sizes.



No. 020-647

Contains 208 Plated Grade 5, UNC Coarse Thread Cap Screws — 20 sizes.



No. 020-648

Contains 376 Plated Hex Nuts, Coarse, Fine and Conelok — 18 sizes.

COMPARATIVE STRENGTH OF CAP SCREWS FORCE COMPARATIVE DE BOULONS HEX

Minimum Tensile Strength p.s.i. (pounds per sq. inch)	S.A.E. Grades 2, 5, and 8	I.S.O. Metric Property Classes	Minimum Tensile Strength MPa (megapascals)
180,000		12.9 Class 12.9	1220
170,000	Grade 8	10.9 Class 10.9	1040
150,000	Grade 5	9.8 Class 9.8	900
140,000		8.8 Class 8.8	830
130,000	Grade 2	5.8 Class 5.8	520
120,000			
110,000			
100,000			
90,000			
80,000			
70,000			
60,000			
50,000			
	1/4, 5/16, 3/8, 7/16, 1/2, 9/16, 5/8, 3/4, 7/8, 1, 1-1/8, 1-1/4, 1-3/8, 1-1/2	M5 — M16 — M24 — M36	
	Diameter (inches)	Diameter (millimetres)	

GRADE 8 HEX HEAD CAP SCREWS PLATED OR BARE BOULONS HEX CLASSE 8 PLAQUÉS OU NUS

077 Coarse Bare	078 Fine Bare	079 Coarse Plated	080 Fine Plated
------------------------------	----------------------------	--------------------------------	------------------------------



Yellow Zinc plated image

- Made to S.A.E. J429 specifications.
- Medium Carbon Alloy Steel.
- Gold Zinc Dichromate plated or Bare Metal.
- Six Radial Bars.
- Double heat treated.

Papco® Grade 8 Cap Screws, identified by the six radial bar head marking, are made of medium carbon alloy steel, quenched and tempered for stronger, safer, more reliable mechanical joints. Use with Grade 8 Nuts to develop the full strength of the Cap Screw. Tensile strength: 150,000 p.s.i. (min.)

ORDER BY STOCK NUMBER

Example of Stock No. 079-586 is 1/2" x 2 Coarse Thread Plated Grade 8 Cap Screw.

Plated UNC Coarse Thread, add prefix 079

Plated UNF Fine Thread, add prefix 080

Threads per inch	UNC	20	18	16	14	13	11	10	9	8	7			
	UNF	28	24	24	20	20	18	16	14	14	12			
Diameter	1/4	5/16	3/8	7/16	1/2	5/8	3/4	7/8	1	1-1/4				
1/2	-305	-440	-	-	-	-	-	-	-	-	-			
3/4	-307	-442	-487	-	-	-	-	-	-	-	-			
1	-309	-444	-489	-534	-579	-668	-	-	-	-	-			
1-1/4	-311	-446	-491	-536	-581	-	-	-	-	-	-			
1-1/2	-313	-448	-493	-538	-583	-672	-714	-	-	-	-			
1-3/4	-315	-450	-495	-	-585	-674	-	-	-	-	-			
2	-316	-451	-496	-541	-586	-675	-717	-762	-803	-	-			
2-1/4	-317	-452	-497	-	-587	-676	-	-	-	-	-			
2-1/2	-318	-453	-498	-543	-588	-677	-719	-764	-805	-	-			
3	-320	-455	-500	-545	-590	-679	-721	-766	-807	-887	-			
3-1/2	-322	-457	-502	-547	-592	-681	-723	-768	-809*	-	-			
4	-324	-459	-504	-549	-594	-683	-725	-770	-811*	-891	-			
4-1/2	-	-	-	-550	-595	-684	-726	-	-	-	-			
5	-326	-461	-506*	-551	-596	-685	-727	-772	-813*	-893	-			
6	-329	-464	-509*	-554	-599*	-688	-730	-775*	-816*	-896	-			
7	-	-	-	-	-	-690	-732	-777*	-818*	-	-			
8	-	-	-	-	-	-692	-734	-779*	-820*	-900	-			
Head Width Across Flats	7/16	1/2	9/16	5/8	3/4	15/16	1-1/8	1-5/16	1-1/2	1-7/8				
Head Height	5/32	13/64	15/64	9/32	5/16	25/64	15/32	35/64	39/64	25/32				
Standard Package	100	100	100	50*	50	50	25*	25	20	20	10*	20	10*	As Required

GRADE 8 HEX NUTS PLATED OR BARE ÉCROUS HEX CLASSE 8 PLAQUÉS OU NUS

089 Coarse Bare	090 Fine Bare	091 Coarse Plated	092 Fine Plated
------------------------------	----------------------------	--------------------------------	------------------------------

- Made to standard finished Hexagon Nut dimensions.
- Gold Zinc Dichromate plated or Bare Metal.



Yellow Zinc plated image

ORDER BY STOCK NUMBER

Diameter	1/4	5/16	3/8	7/16	1/2	5/8	3/4	7/8	1
Stock No.	-014	-016	-018	-020	-022	-024	-026	-028	-030
Across Flats	7/16	1/2	9/16	11/16	3/4	15/16	1-1/8	1-5/16	1-1/2
Standard Package	100	100	100	50	50	25	20	20	20

For Grade 8 Flat Washers see 101 Series Tension Washers - Lock Washers see 101 Series Extra Duty Lock Washers, pages 63 & 94.

GRADE B 'CONELOK' LOCKNUTS ÉCROUS À BLOCAGE 'CONELOK' CLASSE B

061
UNC
Coarse

062
UNF
Fine

Low Carbon Steel

- Proof Stress: 120,000 psi.
- Grade B identified by **three marks.**

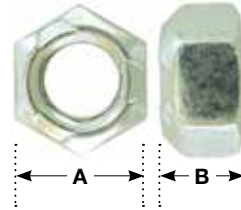

The Conelok Locknut is an improved ONE-PIECE-REUSABLE-PREVAILING TORQUE locknut of superior locking characteristics which are obtained by accurately modifying the threads in the locking section.

Grade B Conelok Locknuts are all steel one piece construction. Lock in any position - are strong, shock-proof and vibration-proof. Easily installed and reusable - starts freely and then requires wrenching as the out-of-round gripping threads engage the bolt. Cadmium plated to resist rust and wax coated to ensure a uniform clamping force.

ORDER BY STOCK NUMBER

UNC - Coarse Thread		Width 'A' x Thickness 'B'	Standard Package
Stock No.	Bolt Diameter Inches		
061-514	1/4-20	7/16 x .257	100
061-516	5/16-18	1/2 x .302	100
061-518	3/8-16	9/16 x .377	100
061-520	7/16-14	11/16 x .430	50
061-522	1/2-13	3/4 x .510	50
061-523	9/16-12	7/8 x .555	25
061-524	5/8-11	15/16 x .645	25
061-526	3/4-10	1-1/8 x .750	20
061-528	7/8-9	1-5/16 x .862	20
061-530	1-8	1-1/2 x .958	20

Used with Grade 2 or Grade 5 Bolts.

UNF - Fine Thread		Width 'A' x Thickness 'B'	Standard Package
Stock No.	Bolt Diameter Inches		
062-514	1/4-28	7/16 x .257	100
062-516	5/16-24	1/2 x .302	100
062-518	3/8-24	9/16 x .377	100
062-520	7/16-20	11/16 x .430	50
062-522	1/2-20	3/4 x .510	50
062-523	9/16-18	7/8 x .555	25
062-524	5/8-18	15/16 x .645	25
062-526	3/4-16	1-1/8 x .750	20
062-528	7/8-14	1-5/16 x .862	20
062-530	1-14	1-1/2 x .958	20

Used with Grade 2 or Grade 5 Bolts.

GRADE C 'CONELOK' LOCKNUTS ÉCROUS À BLOCAGE 'CONELOK' CLASSE C

063
UNC
Coarse

064
UNF
Fine

Medium Carbon Steel, Heat Treated

- Proof Stress: 150,000 psi.
- Grade 'C' identified by **six marks.**

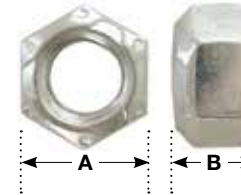

Grade 'C' Heat Treated High-strength Conelok Locknuts are made for **critical applications**, used with heat treated high carbon and alloy steel bolts including S.A.E. Grade 8. The Cadmium finish resists rust and the pre-lubricant wax coating produces a uniform clamping force.

Two sectors of the Conelok Locknut are preformed inwardly. When the nut is applied to the bolt, these deflected threads are elastically returned to a circular form and create an inward and downward pressure which produces intimate contact between the load carrying flanks of the nut and bolt threads. The Conelok nut starts freely and then requires wrenching as the out-of-round gripping threads engage the bolt. The prevailing torque enables the stop nut to remain in a fixed position through a wide adjustment range and it retains its locking ability through many reuses.

ORDER BY STOCK NUMBER

UNC - Coarse Thread		Width 'A' x Thickness 'B'	Standard Package
Stock No.	Bolt Diameter Inches		
063-514	1/4-20	7/16 x .257	100
063-516	5/16-18	1/2 x .302	100
063-518	3/8-16	9/16 x .377	100
063-520	7/16-14	11/16 x .430	50
063-522	1/2-13	3/4 x .510	50
063-523	9/16-12	7/8 x .555	25
063-524	5/8-11	15/16 x .645	25
063-526	3/4-10	1-1/8 x .750	20
063-528	7/8-9	1-5/16 x .862	20
063-530	1-8	1-1/2 x .958	20

Used with Grade 5 or Grade 8 Bolts.

UNF - Fine Thread		Width 'A' x Thickness 'B'	Standard Package
Stock No.	Bolt Diameter Inches		
064-514	1/4-28	7/16 x .257	100
064-516	5/16-24	1/2 x .302	100
064-518	3/8-24	9/16 x .377	100
064-520	7/16-20	11/16 x .430	50
064-522	1/2-20	3/4 x .510	50
064-523	9/16-18	7/8 x .555	25
064-524	5/8-18	15/16 x .645	25
064-526	3/4-16	1-1/8 x .750	20
064-528	7/8-14	1-5/16 x .862	20
064-530	1-14	1-1/2 x .958	20

Used with Grade 5 or Grade 8 Bolts.

UTILITY ASSORTMENTS



These Assortments contain 90 lock nuts from 1/4" to 1/2" Dia. The container is sectionally divided for ease of selection.

No. 020-348

Fine Thread (UNF)
Conelok Locknuts.

No. 020-349

Coarse Thread (UNC)
Conelok Locknuts.



GRADE 2 HEX NUTS BARE ÉCROUS HEX CLASSE 2 NUS

081
UNC
Coarse

082
UNF
Fine

- Finished
- Bare Metal



UNC Coarse	UNF Fine	Size	Standard Package	Width Across Flats	Thickness
Stock No.					
081-014	082-014	1/4	100	7/16	7/32
081-016	082-016	5/16	100	1/2	17/64
081-018	082-018	3/8	100	9/16	21/64
081-020	082-020	7/16	50	11/16	3/8
081-022	082-022	1/2	50	3/4	7/16
081-023	082-023	9/16	25	7/8	31/64
081-024	082-024	5/8	25	15/16	35/64
081-026	082-026	3/4	20	1-1/8	41/64
081-028	082-028	7/8	20	1-5/16	3/4
081-030	082-030	1	20	1-1/2	55/64
081-032	082-032	1-1/8	15	1-11/16	31/32
081-034	082-034	1-1/4	15	1-7/8	1-1/16
081-037	082-037	1-3/8	10	2-1/16	1-11/64
081-038	082-038	1-1/2	10	2-1/4	1-9/32

PLATED GRADE 2 HEX NUTS ÉCROUS HEX CLASSE 2 PLAQUÉS

083
UNC
Coarse

084
UNF
Fine

- Finished
- Bright Plated



UNC Coarse	UNF Fine	Size	Standard Package	Width Across Flats	Thickness
Stock No.					
083-014	084-014	1/4	100	7/16	7/32
083-016	084-016	5/16	100	1/2	17/64
083-018	084-018	3/8	100	9/16	21/64
083-020	084-020	7/16	50	11/16	3/8
083-022	084-022	1/2	50	3/4	7/16
083-023	084-023	9/16	25	7/8	31/64
083-024	084-024	5/8	25	15/16	35/64
083-026	084-026	3/4	20	1-1/8	41/64
083-028	084-028	7/8	20	1-5/16	3/4
083-030	084-030	1	20	1-1/2	55/64

094 Series UNC HEAVY HEX NUTS* BARE ÉCROUS LOURDS HEX UNC NUS



* Jam Nuts also available in sizes listed.

Note: These Nuts conform to ANSI Standard B18.2.2. Nuts with Left Hand Threads are also available.

Stock No.	094-014	094-016	094-018	094-020	094-022	094-023	094-024	094-026	094-028	094-030	094-032	094-034	094-037	094-038
Nut Size & Thread	1/4-20	5/16-18	3/8-16	7/16-14	1/2-13	9/16-12	5/8-11	3/4-10	7/8-9	1-8	1-1/8-7	1-1/4-7	1-3/8-6	1-1/2-6
Std. Pkg.	100	100	100	50	50	25	25	20	20	20	15	15	10	10
Width (Flats)	1/2	9/16	11/16	3/4	7/8	15/16	1-1/16	1-1/4	1-7/16	1-5/8	1-13/16	2	2-3/16	2-3/8
Thickness	15/64	19/64	23/64	27/64	31/64	35/64	39/64	47/64	55/64	63/64	1-7/64	1-7/32	1-11/32	1-15/32

EXTRA DUTY LOCK WASHERS RONDELLES À RESSORT EXTRA ROBUSTES

101
Series

- 4037 High Alloy Steel.
- Mechanical Gold Zinc Dichromate Plated.



For use with Grade 5 or 8 bolts and for high load applications.

Stock No.	Bolt Size	Steel Section W x T	Maximum Thickness	Standard Package
101-014	1/4	.109 x .062	.080	100
101-016	5/16	.125 x .078	.080	100
101-018	3/8	.141 x .094	.080	100
101-020	7/16	.156 x .109	.080	100
101-022	1/2	.171 x .125	.177	50
101-023	9/16	.188 x .141	.177	50
101-024	5/8	.203 x .156	.177	50
101-026	3/4	.234 x .188	.177	40
101-028	7/8	.266 x .219	.177	40
101-030	1	.297 x .250	.177	40
101-032	1-1/8	.411 x .375	.177	20
101-034	1-1/4	.452 x .417	.177	20
101-038	1-1/2	.526 x .496	.177	20

TENSION WASHERS RONDELLES DE TENSION

101
Series

- Heat treated.
- High carbon.
- Plated Steel

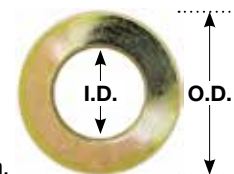

Use two with each Grade 8 cap screw and nut to complete the system.

Stock No.	Bolt Diameter	I.D.	O.D.	Maximum Thickness	Standard Package
101-114	1/4	9/32	5/8	.080	100
101-116	5/16	11/32	11/16	.080	100
101-118	3/8	13/32	13/16	.080	100
101-120	7/16	15/32	59/64	.080	100
101-122	1/2	17/32	1-1/16	.177	50
101-123	9/16	19/32	1-3/16	.177	50
101-124	5/8	11/16	1-5/16	.177	50
101-126	3/4	13/16	1-15/32	.177	40
101-128	7/8	15/16	1-3/4	.177	40
101-130	1	1-1/8	2	.177	40
101-132	1-1/8	1-1/4	2-1/4	.177	20
101-134	1-1/4	1-3/8	2-1/2	.177	20
101-138	1-1/2	1-5/8	3	.177	20

DOUBLE THICKNESS NUTS
ÉCROUS ÉPAISSEUR DOUBLE

102 Series

Light High Nuts

- Low Carbon Steel
- Bare Metal



Papco[®] Double Nuts are used on spring centre bolts, spring 'U' bolts, heavy duty truck wheels, tractor and implement bolts. All Double Thickness Nuts have UNF (S.A.E.) Fine Threads.

For Spring Centre Bolts see page 199.

ORDER BY STOCK NUMBER

Stock No.	Size	Across Flats	Thickness	Std. Package
102-014	1/4-28	.428 - .438	.368 - .382	24
102-016	5/16-24	.489 - .500	.445 - .461	24
102-018	3/8-24	.551 - .562	.491 - .509	24
102-020	7/16-20	.675 - .688	.599 - .619	24
102-022	1/2-20	.736 - .750	.645 - .667	24
102-023	9/16-18	.861 - .875	.754 - .778	24
102-024	5/8-18	.922 - .938	.831 - .857	24
102-027	3/4-16	1.088 - 1.125	.985 - 1.015	24
102-028	7/8-14	1.269 - 1.312	1.140 - 1.172	12
102-030	1-14	1.450 - 1.500	1.294 - 1.330	12
102-034	1-1/4-12	1.812 - 1.875	1.666 - 1.710	12

WING NUTS
ÉCROUS À OREILLE

103 Series

- Strong, well-finished
- Cold forged steel
- Bright, rust-resistant finish



Feature recessed wings for good finger grip.

ORDER BY STOCK NUMBER

Std. Package: 50 pcs

Stock No.	Size	Stock No.	Size
103-010	10-24	103-018	3/8-16
103-014	1/4-20	103-020	7/16-14
103-016	5/16-18	103-022	1/2-13

For Air Cleaner Wing Nuts see page 203.

WING NUT UTILITY ASSORTMENT

No. 020-310

Contains 151 Wing Nuts in five popular sizes. Sturdy fibreboard display box, ideal for Automotive and Hardware use. Each size in an individual compartment.



ACORN (CAP) NUTS
ÉCROUS BORGNES

104 Series

- Durable, smooth-finished Cap Nuts
- Zinc Alloy, Bright Nickel Plated or Zinc Plated Steel



ACORN (CAP) NUT UTILITY ASSORTMENT

No. 020-336

Contains 87 Acorn Nuts in the following popular sizes: 6-32, 8-32, 10-24, 1/4-20, 5/16-18, 3/8-16, 1/2-13. Each size in an individual compartment in a sturdy fibreboard box.



ORDER BY STOCK NUMBER

Zinc Alloy Stock No.	Steel Stock No.	Size & Thread	Std. Pkg	Zinc Alloy Stock No.	Steel Stock No.	Size & Thread	Std. Pkg
104-006	104-106	6-32	100	104-016	104-116	5/16-18	100
104-008	104-108	8-32	100	104-017	—	5/16-24	100
104-010	104-110	10-24	100	104-018	104-118	3/8-16	100
104-011	104-111	10-32	100	104-019	—	3/8-24	100
104-014	104-114	1/4-20	100	104-022	—	1/2-13	50
104-015	—	1/4-28	100	—	—	—	—

PANEL NUTS
ÉCROUS À PANNEAU

106 Series

Precision made Steel and Brass thin nuts for volume controls on radios, chassis connections, toggle switches etc.

Five popular sizes available.



ORDER BY STOCK NUMBER

Std. Package: 25 pcs

Stock No.	Size & Description	Stock No.	Size & Description
106-914	1/4-32 Brass	106-920	7/16-28 Zinc plated Steel
106-916	3/8-24 Zinc plated Steel	106-922	1/2-28 Zinc plated Steel
106-918	3/8-32 Zinc plated Steel		

POZI-LOK[®] STOP NUTS PLATED ÉCROUS POZI-LOK[®] PLAQUÉS

108
UNC
Coarse

109
UNF
Fine

Nylon Insert

These prevailing torque locknuts offer excellent vibration resistance and a wide range of adjustment. The nylon collar prevents liquid seepage and internal corrosion. It is smaller than the bolt diameter and as the bolt enters the collar, the thread form is impressed in the nylon. The resulting compressive forces exert constant friction grip on the bolt and prevent loosening. These nuts may be re-used up to 50 times because the “elastic memory” feature of the nylon causes it to return to its original shape. May be used with Grade 2 and Grade 5 Screws up to 250° F. Bright Zinc Chromate Plated.



ORDER BY STOCK NUMBER

Stock No.	Size	Stock No.	Size	Standard	Dimensions	
UNC Coarse Thread		UNF Fine Thread		Packages	'A' Width	'B' Thickness
108-006	6-32	-	-	100	5/16	.178
108-008	8-32	-	-	100	11/32	.229
108-010	10-24	109-010	10/32	100	3/8	.239
108-014	1/4-20	109-014	1/4-28	100	7/16	.313
108-016	5/16-18	109-016	5/16-24	100	1/2	.344
108-018	3/8-16	109-018	3/8-24	100	9/16	.453
108-020	7/16-14	109-020	7/16-20	50	5/8	.453
108-022	1/2-13	109-022	1/2-20	50	3/4	.594
108-023	9/16-12	109-023	9/16-18	25	7/8	.641
108-024	5/8-11	109-024	5/8-18	25	15/16	.750
108-026	3/4-10	109-026	3/4-16	20	1-1/16	.875
108-028	7/8-9	109-028	7/8-14	20	1-1/4	.984
108-030	1-8	109-030	1-14	20	1-7/16	1.047

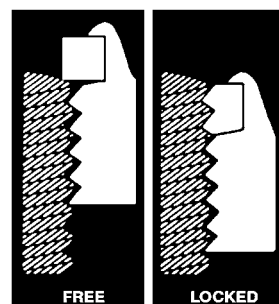

POZI-LOK[®] STOP NUT ASSORTMENT ASSORTIMENTS ÉCROUS POZI-LOK[®]

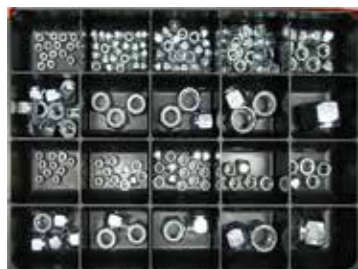

MASTER ASSORTMENT

No. 020-649

This assortment contains 175 nuts in 16 sizes from 1/4" to 3/4" in both Coarse and Fine Thread. Packed in sturdy, metal box with moulded plastic compartments. Illustrated lid label includes retail price codes.

GARAGE ASSORTMENTS

No. 020-064

UNC Coarse Thread

No. 020-065

UNF Fine Thread

Each contains 40 plated Pozi-Lok[®] Stop Nuts 1/4", 5/16", 3/8", 7/16" and 1/2" Dia.

Packed in a clear plastic box.



POZI-LOK[®] DOUBLE NUT ÉCROUS DOUBLE POZI-LOK[®]

111
Series

These Nylon Insert, prevailing torque lock nuts offer excellent vibration resistance and assure positive locking under severe shock. Used for Spring Centre Bolts. Spring U-Bolts etc. UNF Fine Thread.



ORDER BY STOCK NUMBER

Std. Package: 5 pcs

Stock No.	Size	Dimensions	
		Width 'A'	Thickness 'B'
111-018	3/8-24	35/64	41/64
111-020	7/16-20	5/8	49/64
111-022	1/2-20	3/4	13/16
111-024	5/8-18	15/16	1

**FLANGE NUTS
ÉCROUS DE REBORD**

**118
Series**

Papco[®] Flange Nuts provide better load distribution in fastening metal parts, wood or other soft materials. The flange bridges an oversize or elongated hole and eliminates the need for washers.

Two styles:

- (A) Tensilock - one-piece, hardened, free running lock nuts have ratchet teeth in their base - bite into surface and hold tight under vibration.
- (B) Standard - in regular and large flange (L) patterns.

For Metric Flange Nuts see pages 37 & 39

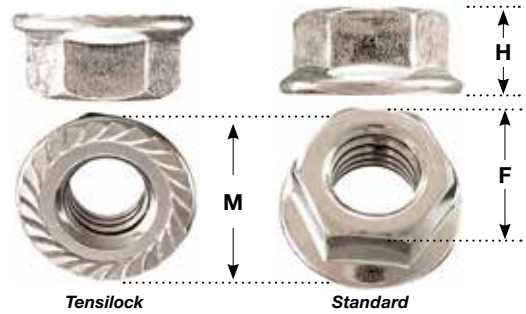

ORDER BY STOCK NUMBER

Std. Package: 100 pcs

Stock No.		Thread Size	Dimensions		
Tensilock	Standard		Hex 'F'	Thick 'H'	Flange 'M'
118-014	118-114	1/4-20	7/16	15/64	19/32
118-016	118-116	5/16-18	1/2	9/32	43/64
-	118-117	5/16-18 L	1/2	23/64	13/16
118-018	118-118	3/8-16	9/16	11/32	47/64
-	118-119	3/8-16 L	9/16	25/64	29/32
-	118-120	7/16-14	11/16	25/64	59/64
118-022	118-122	1/2-13	3/4	29/64	1-1/64

GARAGE ASSORTMENT

No. 020-053

- Contains 50 locking flange nuts, five sizes from 1/4"-20 to 1/2"-13.
- Packed in a clear plastic box.
- Useful in many repairs where a flange nut is needed.



**KEPS[®] LOCKNUTS
ÉCROUS À BLOCAGE KEPS[®]**

**119
Series**

Consists of a pre-assembled hexagon nut and a tooth lock washer. The tapered, twisted locking teeth provide full locking action when the nut is seated. American Standard Machine Screw sizes. Bright Plated.

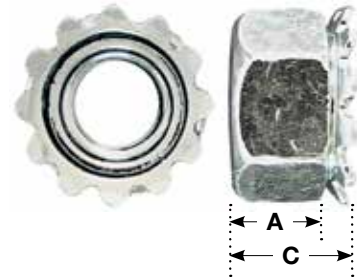

ORDER BY STOCK NUMBER

Std. Package: 100 pcs

Stock No.	Keps [®] Nut Size	Width Across Flats	Overall Thickness (C)	Nut Thickness (A)
119-006	6-32	5/16	9/64	7/64
119-008	8-32	11/32	5/32	1/8
119-010	10-24	3/8	5/32	1/8
119-011	10-32	3/8	5/32	1/8
119-014	1/4-20	7/16	15/64	3/16
119-015	1/4-28	7/16	15/64	3/16
119-016	5/16-18	1/2	11/32	9/32
119-018	3/8-16	9/16	7/16	3/8

GARAGE ASSORTMENT

No. 020-055

- This Assortment contains 75 'KEPS[®]' Locknuts in each of the sizes listed.
- Packed in a sturdy four compartment clear plastic box with a hinged lid.



**ELEVATOR BOLTS
BOULONS D'ASCENSEUR NUS**

**125
Series**

These flat countersunk head square neck Elevator Bolts have large diameter flush heads. Used on elevator buckets and industrial belting where low head clearance is needed. Also used extensively in truck and trailer applications for walls, floors, racks and trailer doors.

ORDER BY STOCK NUMBER

Stock No.	Size	Stock No.	Size	Stock No.	Size
125-307	1/4 x 3/4	125-442	5/16 x 3/4	-	-
125-309	1	125-444	1	-	-
125-311	1-1/4	125-446	1-1/4	125-491	3/8 x 1-1/4
125-313	1-1/2	125-448	1-1/2	125-493	1-1/2
125-316	2	125-451	2	125-496	2
Head Diameter	1	1-3/16		1-5/16	

- Bare Metal
- UNC Coarse Thread
- Stress Relieved



Length measured overall

PLATED CARRIAGE BOLTS BOULONS DE CARROSSE PLAQUÉS

129
Series

Used extensively for Truck Rack and Floorboard construction or repair. Fully threaded for proper fit and adjustment in wood.



ORDER BY STOCK NUMBER

Length Overall	Bolt Diameter							
	1/4	Std. Pkg.	5/16	Std. Pkg.	3/8	Std. Pkg.	1/2	Std. Pkg.
3/4	129-307	100	129-442	100	129-487	100	-	-
1	129-309	100	129-444	100	129-489	100	129-579	50
1-1/4	129-311	100	129-446	100	129-491	100	129-581	50
1-1/2	129-313	100	129-448	100	129-493	100	129-583	50
2	129-316	100	129-451	100	129-496	100	129-586	50
2-1/2	129-318	100	129-453	100	129-498	100	129-588	50
3	129-320	100	129-455	100	129-500	100	129-590	50
3-1/2	129-322	100	129-457	100	129-502	100	129-592	50
4	129-324	100	129-459	100	129-504	100	129-594	50
4-1/2	129-325	100	129-460	100	129-505	100	129-595	50
5	129-326	100	129-461	100	129-506	50	129-596	25
6	129-329	100	129-464	50	129-509	50	129-599	25
8	-	-	-	-	129-513	50	129-603	25
10	-	-	-	-	129-517	10	129-607	10
12	-	-	-	-	129-520	10	129-610	10

Note: Plated Grade 5 Carriage Bolts are available. See current price list Industrial Price Book. Full shank Carriage Bolts available upon request.

PLATED CARRIAGE BOLTS BOULONS DE CARROSSE PLAQUÉS

129
Series

UTILITY ASSORTMENT

No. 020-330

- This Assortment contains 70 Plated Bolts and Nuts, 14 sizes.
- Each size in a compartment in a sturdy fibre-board container with retail prices shown.
- Particularly useful for farm, garage and general repair work.



PLATED GRADE 5 PLOW BOLTS BOULONS DE CHARRUE CLASSE 5 PLAQUÉS

133
Series

- Regular No. 3 Head
- High Carbon Steel
- Double Heat Treated

Papco® Plow Bolt heads are round and countersunk with a square neck. Oversize heads for 3/8" Dia. are 7/16" Dia. head and 7/16" Dia. is 1/2" Dia. head. Length is measured overall from end of bolt to the top of the head. Other heads and styles are available.



ORDER BY STOCK NUMBER

Standard Package: 3/8" Dia. 100; 7/16" and 1/2" Dia. 50; 5/8" Dia. 25

Length Overall	Standard Head				Oversize Head		Length Overall	Standard Head				Oversize Head	
	3/8	7/16	1/2	5/8	3/8	7/16		3/8	7/16	1/2	5/8	3/8	7/16
1	133-489	133-534	-	-	-	-	2	133-496	133-541	133-586	133-675	-	133-820
1-1/4	133-491	133-536	133-581	-	133-791	-	2-1/4	-	-	-	133-676	-	133-822
1-1/2	133-493	133-538	133-583	133-672	133-793	-	2-1/2	133-498	133-543	133-588	133-677	-	133-824
1-3/4	133-495	133-540	133-585	133-674	-	133-816	3	-	133-545	133-590	133-679	-	-

PLATED LAG BOLTS TIRE-FONDS PLAQUÉS

135
Series

- Hex Head
- Sharp Gimlet Point



ORDER BY STOCK NUMBER

Standard Package: 100, *50, **25

Dia. Length		1/4	5/16	3/8	1/2	Dia. Length		1/4	5/16	3/8	1/2
1	135-309	135-444	-	-	-	4	135-324	135-459	135-504	135-594*	
1-1/4	135-311	135-446	-	-	-	4-1/2	135-325	135-460	135-505	135-595*	
1-1/2	135-313	135-448	135-493	-	-	5	135-326	135-461	135-506*	135-596*	
2	135-316	135-451	135-496	135-586*	-	6	135-329	135-464	135-509*	135-599**	
2-1/2	135-318	135-453	135-498	135-588*	-	7	-	-	135-511*	135-601**	
3	135-320	135-455	135-500	135-590*	-	8	-	-	135-513*	135-603**	
3-1/2	135-322	135-457	135-502	135-592*	-						

Length of Lag Bolt is measured from under head to end of point. Thread is one-half of length plus 1/2". Larger and longer sizes are available.

**LAG BOLT SHIELDS
CHEVILLES POUR TIRE-FOND**

135 Series

Papco® Lag Shields are a screw type anchor designed to be used with Lag Screws. Short type shields are used in harder masonry materials to reduce drilling time. The long version is used in soft masonry to develop better holding strength. For use in concrete or mortar joints of brick or block walls.



ORDER BY STOCK NUMBER

Stock No.	135-801	135-803	135-805	135-807	135-809	135-811	135-813	135-815
Diameter	1/4		5/16		3/8		1/2	
Length	1	1-1/2	1-1/4	1-3/4	1-3/4	2-1/2	2	3
Drill Hole	1/2	1/2	1/2	1/2	5/8	5/8	3/4	3/4
Std. Pkg.	25	25	25	15	20	10	10	10

For Masonry Drill Bits see page 224.

**SQUARE HEAD SET SCREWS
VIS DE PRESSION À TÊTE CARRÉE**

136 Series

- Case Hardened
- Cup Point
- Coarse Thread (UNC)



ORDER BY STOCK NUMBER

Stock No.	Size	Stock No.	Size	Stock No.	Size	Stock No.	Size	Stock No.	Size
136-303	1/4 x 3/8	136-440	5/16 x 1/2	136-485	3/8 x 1/2	136-532	7/16 x 3/4	136-577	1/2 x 3/4
136-305	1/4 x 1/2	136-442	5/16 x 3/4	136-487	3/8 x 3/4	136-534	7/16 x 1	136-579	1/2 x 1
136-307	1/4 x 3/4	136-444	5/16 x 1	136-489	3/8 x 1	136-536	7/16 x 1-1/4	136-581	1/2 x 1-1/4
136-309	1/4 x 1	136-446	5/16 x 1-1/4	136-493	3/8 x 1-1/2	136-541	7/16 x 2	136-583	1/2 x 1-1/2
136-313	1/4 x 1-1/2	136-448	5/16 x 1-1/2	136-496	3/8 x 2			136-586	1/2 x 2
Std. Pkgs.	100	100	100	100	50	50			

The length of a square head set screw is measured from under the head to the extreme point. Screws are threaded entire length of the body.



GARAGE ASSORTMENT

- **No. 020-046**
- Contains 35 Square Head Set Screws in 10 sizes.
- Packed in transparent plastic box with hinged lid.



UTILITY ASSORTMENT

- **No. 020-344**
- This assortment contains 66 Square Head Set Screws, 10 popular sizes: 1/4 x 1/2", 5/16 x 3/4", 1", 1-1/2"; 3/8 x 3/4", 1-1/2"; 1/2 x 1", 2".
- Packed in a sturdy fibreboard container. The lid label is illustrated and shows retail prices.



MASTER ASSORTMENT

- **No. 020-636**
- This assortment contains 82 screws, 20 popular sizes, and is packed in a sturdy, metal sectional divided box.
- The hinged lid contains an illustrated label with resale prices. Container has locking handle.

SOCKET FASTENERS

ATTACHES DE PRESSION

SOCKET HEAD CAP SCREWS

SOCKET SET SCREWS

SOCKET SCREW KEYS

SOCKET KEY SETS

LONG ARM SOCKET KEY SETS

- IMPERIAL

- METRIC

SOCKET HEAD CAP SCREWS BARE BOULONS DE PRESSION NU

137*
UNRC
Coarse

1372
UNRC
Coarse



- 1960 Series
- Alloy Steel
- High Strength

Papco® Socket Cap Screws are made from alloy steel and have a tensile strength of 165,000 p.s.i. Sizes listed are National Coarse Thread, UNRC. Additional sizes are available.

ORDER BY STOCK NUMBER

Size Dia. x Length	Stock No.	Pkg Qty	Stock No.	Pkg Qty	Use Wrench
6-32 DIAMETER					
6-32 x 3/8	1372-085	100	-	-	7/64
6-32 x 1/2	1372-087	100	-	-	
6-32 x 5/8	1372-088	100	-	-	
6-32 x 3/4	1372-089	100	-	-	
6-32 x 7/8	1372-090	100	-	-	
6-32 x 1	1372-091	100	-	-	
8-32 DIAMETER					
8-32 x 3/8	1372-135	100	-	-	9/64
8-32 x 1/2	1372-137	100	-	-	
8-32 x 3/4	1372-139	100	-	-	
8-32 x 1	1372-141	100	-	-	
8-32 x 1-1/4	1372-143	100	-	-	
8-32 x 1-1/2	1372-145	100	-	-	
8-32 x 2	1372-148	100	-	-	
10-24 DIAMETER					
10-24 x 3/8	1372-187	100	-	-	5/32
10-24 x 1/2	1372-189	100	-	-	
10-24 x 5/8	1372-190	100	-	-	
10-24 x 3/4	1372-191	100	-	-	
10-24 x 1	1372-193	100	-	-	
10-24 x 1-1/4	1372-195	100	-	-	
10-24 x 1-1/2	1372-197	100	-	-	
10-24 x 2	1372-200	100	-	-	
10-32 DIAMETER					
10-32 x 3/8	1372-215	100	-	-	5/32
10-32 x 1/2	1372-217	100	-	-	
10-32 x 5/8	1372-218	100	-	-	
10-32 x 3/4	1372-219	100	-	-	
10-32 x 1	1372-221	100	-	-	
10-32 x 1-1/4	1372-223	100	-	-	
10-32 x 1-1/2	1372-225	100	-	-	
10-32 x 2	1372-228	100	-	-	
1/4-20 DIAMETER					
1/4-20 x 1/2	1372-305	100	137-305*	25	3/16
1/4-20 x 3/4	1372-307	100	137-307*	25	
1/4-20 x 1	1372-309	100	137-309*	25	
1/4-20 x 1-1/4	1372-311	100	137-311*	25	
1/4-20 x 1-1/2	1372-313	100	137-313*	25	
1/4-20 x 1-3/4	-	-	137-315*	25	
1/4-20 x 2	1372-316	100	137-316*	25	
1/4-20 x 2-1/2	1372-318	100	-	-	
1/4-20 x 3	1372-320	100	-	-	

*Standard Package Contains 25 Screws

Size Dia. x Length	Stock No.	Pkg Qty	Stock No.	Pkg Qty	Use Wrench
5/16-18 DIAMETER					
5/16-18 x 1/2	1372-440	100	-	-	1/4
5/16-18 x 3/4	1372-442	100	137-442*	25	
5/16-18 x 1	1372-444	100	137-444*	25	
5/16-18 x 1-1/4	1372-446	100	137-446*	25	
5/16-18 x 1-1/2	1372-448	100	137-448*	25	
5/16-18 x 1-3/4	1372-450	100	137-450*	25	
5/16-18 x 2	1372-451	100	137-451*	25	
5/16-18 x 2-1/2	1372-453	100	-	-	
5/16-18 x 3	1372-455	100	-	-	
5/16-18 x 3-1/2	1372-457	100	-	-	
5/16-18 x 4	1372-459	100	-	-	
3/8-16 DIAMETER					
3/8-16 x 1/2	1372-485	100	-	-	5/16
3/8-16 x 3/4	1372-487	100	137-487*	25	
3/8-16 x 7/8	1372-488	100	-	-	
3/8-16 x 1	1372-489	100	137-489*	25	
3/8-16 x 1-1/4	1372-491	100	137-491*	25	
3/8-16 x 1-1/2	1372-493	100	137-493*	25	
3/8-16 x 1-3/4	1372-495	100	137-495*	25	
3/8-16 x 2	1372-496	100	137-496*	25	
3/8-16 x 2-1/4	1372-497	100	-	-	
3/8-16 x 2-1/2	1372-498	50	137-498*	25	
3/8-16 x 3	1372-500	50	-	-	
3/8-16 x 3-1/2	1372-502	50	-	-	
3/8-16 x 4	1372-504	50	-	-	
3/8-16 x 4-1/2	1372-505	50	-	-	
3/8-16 x 5	1372-506	50	-	-	
7/16-14 DIAMETER					
7/16-14 x 1	1372-534	100	-	-	3/8
7/16-14 x 1-1/4	1372-536	100	-	-	
7/16-14 x 1-1/2	1372-538	100	-	-	
7/16-14 x 2	1372-541	50	-	-	
7/16-14 x 2-1/2	1372-542	50	-	-	
7/16-14 x 3	1372-545	50	-	-	
1/2-13 DIAMETER					
1/2-13 x 1	1372-579	50	-	-	3/8
1/2-13 x 1-1/4	1372-581	50	-	-	
1/2-13 x 1-1/2	1372-583	50	137-583*	25	
1/2-13 x 1-3/4	1372-585	50	-	-	
1/2-13 x 2	1372-586	50	137-586*	25	
1/2-13 x 2-1/4	1372-587	50	-	-	
1/2-13 x 2-1/2	1372-588	50	137-588*	25	
1/2-13 x 2-3/4	1372-589	50	-	-	
1/2-13 x 3	1372-590	50	-	-	
1/2-13 x 3-1/2	1372-592	25	-	-	
1/2-13 x 4	1372-594	25	-	-	
1/2-13 x 5	1372-596	25	-	-	

SOCKET HEAD CAP SCREWS BARE BOULONS DE PRESSION NU

1372
UNRC
Coarse



- 1960 Series
- Alloy Steel
- High Strength

Papco® Socket Cap Screws are made from alloy steel and have a tensile strength of 165,000 p.s.i. Sizes listed are National Coarse Thread, UNRC. Additional sizes are available.

ORDER BY STOCK NUMBER

Size Dia. x Length	Stock No.	Pkg Qty	Stock No.	Pkg Qty	Use Wrench	
5/8-11 DIAMETER						
5/8-11 x 1-1/2	1372-672	50	-	-	1/2	
5/8-11 x 1-3/4	1372-674	50	-	-		
5/8-11 x 2	1372-675	50	-	-		
5/8-11 x 2-1/4	1372-676	25	-	-		
5/8-11 x 2-1/2	1372-677	25	-	-		
5/8-11 x 2-3/4	1372-678	25	-	-		
5/8-11 x 3	1372-679	25	-	-		
5/8-11 x 3-1/4	1372-680	25	-	-		
5/8-11 x 3-1/2	1372-681	25	-	-		
5/8-11 x 4	1372-683	25	-	-		
3/4-10 DIAMETER						
3/4-10 x 2	1372-717	25	-	-		5/8
3/4-10 x 2-1/4	1372-718	25	-	-		
3/4-10 x 2-1/2	1372-719	25	-	-		
3/4-10 x 2-3/4	1372-720	25	-	-		
3/4-10 x 3	1372-721	25	-	-		
3/4-10 x 3-1/2	1372-723	25	-	-		
3/4-10 x 4	1372-725	25	-	-		
3/4-10 x 4-1/2	1372-726	25	-	-		
3/4-10 x 5	1372-727	25	-	-		
3/4-10 x 6	1372-730	10	-	-		

Size Dia. x Length	Stock No.	Pkg Qty	Stock No.	Pkg Qty	Use Wrench	
7/8-9 DIAMETER						
7/8-9 x 2	1372-762	10	-	-	3/4	
7/8-9 x 2-1/2	1372-764	10	-	-		
7/8-9 x 3	1372-766	10	-	-		
7/8-9 x 3-1/2	1372-768	10	-	-		
7/8-9 x 4	1372-770	10	-	-		
7/8-9 x 4-1/2	1372-771	10	-	-		
7/8-9 x 5	1372-772	10	-	-		
7/8-9 x 6	1372-775	10	-	-		
1-8 DIAMETER						
1-8 x 2	1372-803	10	-	-		3/4
1-8 x 2-1/2	1372-805	10	-	-		
1-8 x 3	1372-807	10	-	-		
1-8 x 3-1/2	1372-809	10	-	-		
1-8 x 4	1372-812	10	-	-		
1-8 x 4-1/2	1372-813	10	-	-		
1-8 x 5	1372-814	10	-	-		
1-8 x 6	1372-816	10	-	-		

UTILITY ASSORTMENT

No. 020-328

This Assortment contains 36 Socket Head Cap Screws, 12 popular sizes from 1/4" x 3/4" to 1/2" x 2-1/2" coarse thread. Each size is in an individual compartment in a sturdy fibreboard container.



SOCKET SET SCREWS BARE VIS DE PRESSION NU

1382
UNRC/UNRF
Coarse/Fine

138
UNRC
Coarse

139
UNRF
Fine



Papco® Socket Set Screws are made from heat treated alloy steel and have ground threads.
Sizes listed are standard cup point.

ORDER BY STOCK NUMBER

Size Dia. x Length	Stock No.	Pkg Qty	Stock No.	Pkg Qty	Use Wrench	
6-32 DIAMETER						
6-32 x 1/8	-	100	138-081*	25	1/16	
6-32 x 3/16	-	100	138-082*	25		
6-32 x 1/4	-	100	138-083*	25		
8-32 DIAMETER						
8-32 x 1/8	-	-	138-130*	25	5/64	
8-32 x 3/16	-	-	138-132*	25		
8-32 x 1/4	1382-133	100	138-133*	25		
8-32 x 5/16	1382-134	100	138-134*	25		
8-32 x 3/8	1382-135	100	138-135*	25		
8-32 x 1/2	1382-137	100	-	-		
8-32 x 5/8	1382-138	100	-	-		
8-32 x 3/4	1382-139	100	-	-		
10-24 DIAMETER						
10-24 x 3/16	1382-184	100	138-184*	25		3/32
10-24 x 1/4	1382-185	100	138-185*	25		
10-24 x 5/16	1382-186	100	138-186*	25		
10-24 x 3/8	1382-187	100	138-187*	25		
10-24 x 1/2	1382-189	100	-	-		
10-24 x 5/8	1382-190	100	-	-		
10-24 x 3/4	1382-191	100	-	-		
10-24 x 1	1382-193	100	-	-		
10-32 DIAMETER (UNRF – FINE THREAD)						
10-32 x 3/16	-	-	139-184*	25	3/32	
10-32 x 1/4	1382-213	100	139-185*	25		
10-32 x 5/16	1382-214	100	139-186*	25		
10-32 x 3/8	1382-215	100	-	-		
10-32 x 1/2	1382-217	100	-	-		
10-32 x 5/8	1382-218	100	-	-		
10-32 x 3/4	1382-219	100	-	-		
10-32 x 1	1382-221	100	-	-		
1/4-20 DIAMETER						
1/4-20 x 1/4	1382-301	100	138-301*	25		1/8
1/4-20 x 5/16	1382-302	100	138-302*	25		
1/4-20 x 3/8	1382-303	100	138-303*	25		
1/4-20 x 1/2	1382-305	100	138-305*	25		
1/4-20 x 5/8	1382-306	100	-	-		
1/4-20 x 3/4	1382-307	100	-	-		
1/4-20 x 1	1382-309	100	-	-		
1/4-28 DIAMETER						
1/4-28 x 1/4	-	-	139-301*	25	1/8	
1/4-28 x 3/8	-	-	139-303*	25		

Size Dia. x Length	Stock No.	Pkg Qty	Stock No.	Pkg Qty	Use Wrench
5/16-18 DIAMETER					
5/16-18 x 5/16	1382-437	100	138-437*	25	5/32
5/16-18 x 3/8	1382-438	100	138-438*	25	
5/16-18 x 1/2	1382-440	100	138-440*	25	
5/16-18 x 5/8	1382-441	100	-	-	
5/16-18 x 3/4	1382-442	100	-	-	
5/16-18 x 1	1382-444	100	-	-	
5/16-24 DIAMETER					
5/16-24 x 5/16	-	-	139-437*	25	5/32
3/8-16 DIAMETER					
3/8-16 x 3/8	1382-483	100	138-483*	25	3/32
3/8-16 x 1/2	1382-485	100	138-485*	25	
3/8-16 x 5/8	1382-486	100	138-486*	25	
3/8-16 x 3/4	1382-487	100	-	-	
3/8-16 x 1	1382-489	100	-	-	
3/8-16 x 1-1/4	1382-491	100	-	-	
3/8-16 x 1-1/2	1382-493	100	-	-	
3/8-24 DIAMETER					
3/8-24 x 3/8	-	-	139-483*	25	3/16
1/2-13 DIAMETER					
1/2-13 x 1/2	1382-575	100	138-575*	25	1/4
1/2-13 x 5/8	1382-576	100	138-576*	25	
1/2-13 x 3/4	1382-577	100	-	-	
1/2-13 x 7/8	1382-578	100	-	-	
1/2-13 x 1	1382-579	100	-	-	
5/8-11 DIAMETER					
5/8-11 x 1/2	1382-662	50	-	-	5/16
5/8-11 x 5/8	1382-665	50	138-665*	25	
5/8-11 x 3/4	1382-666	50	-	-	
5/8-11 x 1	1382-668	50	-	-	

*Standard Package Contains 25 Screws

SOCKET SCREW KEYS CLÉS DE VIS CREUX

140
Series



Papco[®] Socket Screw Keys are made of close tolerance alloy steel. All Keys have chamfered ends for easy insertion. These Keys are available in Short and Long Arm Series. Short Arm Series supplied unless otherwise specified.

ORDER BY STOCK NUMBER

Standard Package: contains 12 Keys

Stock No.		Hex Width Across Flats	Length of Short Arm	Length of Longer Arm		For Screw Diameter						
Short Arm	Long Arm			Short Series	Long Series	Socket Set	Socket Head Cap Screws		Flat Head Cap Screws	Button Head Cap Screws	Shoulder Screws	Pipe Plugs
							1960 Series	1936 Series				
140-101	140-201	1/16	9/16	1-3/4	-	No. 5, 6	-	No. 2	No. 4	No. 4	-	-
140-102	140-202	5/64	39/64	1-7/8	3-3/16	No. 8	No. 2, 3	No. 3, 4	No. 5, 6	No. 6	-	-
140-103	140-203	3/32	21/32	2	3-3/8	No. 10, 12	No. 4, 5	No. 5, 6	No. 8	No. 8	-	-
140-104	140-204	7/64	11/16	2-1/8	3-1/2	-	No. 6	-	-	-	-	-
140-105	140-205	1/8	3/4	2-1/4	3-3/4	1/4	-	No. 8	No. 10	No. 10	-	-
140-106	140-206	9/64	13/16	2-3/8	3-7/8	-	No. 8	-	-	-	-	-
140-107	140-207	5/32	27/32	2-1/2	4-1/8	5/16	No. 10	No. 10, 12	1/4	1/4	5/16	1/16
140-108	140-208	3/16	15/16	2-3/4	4-1/2	3/8	1/4	1/4	5/16	5/16	3/8	1/8
140-109	140-209	7/32	1-1/32	3	4-7/8	7/16	-	5/16	3/8	3/8	-	-
140-110	140-210	1/4	1-1/8	3-1/4	5-1/4	1/2, 9/16	5/16	-	7/16	-	1/2	1/4
140-111	140-211	5/16	1-1/4	3-3/4	6	5/8	3/8	3/8, 7/16	1/2	1/2	5/8	3/8
140-112	140-212	3/8	1-3/8	4-1/4	6-3/4	3/4	7/16, 1/2	1/2, 9/16	5/8, 3/4	5/8	3/4	1/2

SOCKET KEY SETS JEU DE CLÉS CREUX

Socket Key Sets are made of alloy tool steel for extended tool life. All keys have chamfered ends for easy insertion. Key sets are available in Inch, Metric and as a 6-Lobe security set in a colour-coded, lightweight, aluminum body.

ORDER BY STOCK NUMBER

Stock No.	Aluminum Case Socket Key Sets
140-520	5/64, 3/32, 7/64, 1/8, 9/64, 5/32, 3/16, 7/32, 1/4
140-521	5/32, 3/16, 7/32, 1/4, 5/16, 3/8
140-620	1.5, 2, 2.5, 3, 4, 5, 6 mm
140-625	T8, T9, T10, T15, T20, T25, T30, T40 Security



No. 140-521 (Inch)
6 Keys



No. 140-520 (Inch)
9 Keys



No. 140-620 (Metric)
7 Keys



No. 140-625 (6-Lobe Security)
8 Keys

**FOLDING PLASTIC SOCKET KEY SETS
JEU DE CLÉS PLIANTE EN PLASTIQUE**

A professional quality kit made from chrome alloy steel, heat treated to give the best combination of toughness and torsional strength. Each key folds into a sturdy protective plastic case.

ORDER BY STOCK NUMBER

Stock No.	Folding Plastic Socket Key Sets
140-515	5/64, 3/32, 7/64, 1/8, 9/64, 5/32, 3/16, 7/32, 1/4
140-615	1.5, 2, 2.5, 3, 4, 5, 5.5, 6 mm
140-626	T9, T10, T15, T20, T25, T27, T30, T40



No. 140-515 (Inch)
9 Keys



No. 140-615 (Metric)
8 Keys



No. 140-626 (6-Lobe)
8 Keys

**LONG ARM SOCKET KEY SETS
JEU DE CLÉS BRAS LONGEUR**

These Long Arm Socket Keys provide additional leverage and accessibility when tightening in hard to reach places. These Socket Keys are manufactured to rigid tolerances from precisely heat treated chrome alloy steel which gives a uniform length and bend.

ORDER BY STOCK NUMBER

Stock No.	Long Arm Socket Key Sets	Key Qty
140-530	0.05, 1/16, 3/64, 3/32, 7/64, 1/8, 9/64, 5/32, 3/16, 7/32, 1/4, 5/16, 3/8	13
140-630	1.5, 2, 2.5, 3, 4, 5, 6, 8, 10 mm	9

*Socket Key Merchandiser P.O.P. Display #022-015 see page 124.



No. 140-530 (Inch)
13 Keys



No. 140-630 (Metric)
9 Keys

SHORT ARM KEYS KIT

No. 020-858

- Contains 7 Hexagon Alloy Steel Keys, Short Arm Series
- Hex. sizes: 5/64 • 3/32 • 1/8 • 5/32 • 3/16 • 7/32 • 1/4
- Transparent Plastic Case.
- Fit Socket Set Screws from No. 8 to 1/2" Diameter.
- Fit Socket Screws from No. 2 to 5/16" Diameter.
- A professional quality kit made from chrome alloy steel, heat treated to give the best combination of toughness and torsional strength.

(Five 020-858 kits in a master package.)



020-858

SOCKET SET SCREW ASSORTMENTS ASSORTIMENTS VIS DE PRESSION

GARAGE ASSORTMENT

No. 020-855

This assortment is designed for Mechanics, Refrigerator, Oil-Burner and Appliance Servicemen. The re-usable container fits any tool kit.

- Contains 84 Socket Set Screws and 5 Hexagon Keys
- 10 popular sizes of Set Screws:
8-32 x 3/16", 10-24 x 3/16", 1/4-20 x 1/4",
8-32 x 1/4", 10-24 x 1/4", 1/4-20 x 3/8", 5/16-18 x
5/16", 3/8-16 x 3/8", 5/16-18 x 3/8", 3/8-16 x 1/2"
- Transparent styrene plastic container.
- Illustrated label shows size and retail prices.
- Refills available in standard packages.



020-855

UTILITY ASSORTMENT

No. 020-321

Packed in a sturdy fibreboard container with a separate compartment for each size. Lid label is illustrated and shows retail prices.

- Contains 120 Socket Set Screws.
- 12 popular sizes:
8-32 x 3/16", 10-24 x 3/16", 1/4-20 x 1/4",
8-32 x 1/4" 10-24 x 1/4", 1/4-20 x 3/8",
1/4-28 x 1/4", 5/16-18 x 5/16", 3/8-16 x 3/8",
5/16-24 x 5/16", 5/16-18 x 3/8", 3/8-16 x 1/2"



020-321

**SOCKET SET SCREW ASSORTMENTS
ASSORTIMENTS VIS DE PRESSION**

MASTER ASSORTMENT

No. 020-629

Packed in a rigid all metal hinged lid box with illustrated lid label showing retail prices. Assortment can be refilled from standard packages.

- Contains 166 Socket Set Screws in the following sizes: (Quantities are adjusted according to popularity).

8-32 x 3/16", 10-24 x 3/16", 3/8-16 x 3/8",
8-32 x 1/4", 10-24 x 1/4", 1/2-13 x 1/2",
1/4-20 x 1/4", 5/16-18 x 5/16", 10-32 x 3/16",
1/4-20 x 3/8", 5/16-18 x 3/8", 1/4-28 x 1/4",
1/4-20 x 1/2", 5/16-18 x 1/2", 5/16-24 x 5/16"

020-629



SUPER SERVICE ASSORTMENT

No. 020-803

- Contains 240 Socket Set Screws — 32 sizes plus keys.
- Large size, rigid metal box with high-strength plastic compartments.

For more details see page 10.

Size: 12" W x 18" L x 3" D

020-803





PINS AND CLIPS GOUPILLES ET AGRAFES

SAFETY PINS

COTTER PINS

CLEVIS YOKES

CLEVIS PINS

HITCH PIN CLIPS

SLOTTED SPRING PINS

TAPER PINS

SAFETY PINS ÉPINGLES DE SÛRETÉ

126
Series

Papco® Safety Pins are made from hard drawn plated spring wire and afford positive locking action for retaining Clevis and other types of pins. Used on farm equipment, industrial applications, trucks etc. wherever safety is an issue.

ORDER BY STOCK NUMBER

Standard Package: 10 Pins

Stock No.	Inside Clearance 'A'	Overall Length	Usable Length	Stock No.	Inside Clearance 'A'	Overall Length	Usable Length
126-932	3/8	1-3/4	1-1/16	126-936	13/16	4-3/8	2-13/16
126-934	5/8	2-3/4	1-11/16	126-938	1-1/8	5-3/4	3-3/4



COTTER PINS GOUPILLES

165
C's
Hundreds

Bright Electro-Plated With Chromate Finish

Papco® steel Cotter Pins are made in the extended prong style for easy insertion and locking. The length is measured under the head to the end of the shortest leg. Packaging is in standard packages of 100 pieces and all Cotter Pins are bright plated.



ORDER BY STOCK NUMBER

Example of stock number 165-148 is 1/8 x 2 steel Cotter Pins plated in packages of 100

Packages of 100 pieces

Length	1/32	3/64	1/16	5/64	3/32	7/64	1/8	5/32	3/16	1/4	5/16	3/8
1/2	-019	-030	-043		-087		-137					
3/4		-032	-045	-065	-089		-139					
1			-047	-067	-091	-115	-141	-167	-193			
1-1/4			-049		-093		-143	-169	-195			
1-1/2			-051		-095	-119	-145	-171	-197	-313	-448	
1-3/4			-053		-097		-147	-173				
2			-054		-098		-148	-174	-200	-316	-451	-496
2-1/2					-100		-150	-176	-202	-318	-453	-498
3							-152	-178	-204	-320	-455	-500
3-1/2										-322	-457	-502
4										-324	-459	-504

COTTER PIN ASSORTMENT

No. 020-866

This Assortment consists of approximately 100 Cotter Pins in 1/16", 3/32", and 1/8" Dia., and from 1/2" to 1-1/4" in lengths. Standard package contains 24 individual assortments. All bright plated.

020-866



GARAGE ASSORTMENT

No. 020-033

Contains 340 Cotter Pins, 7 sizes from 1/16" x 3/4" to 5/32" x 2". Packed in handy, clear plastic container. All bright plated.

020-033



NOTE: For our full line of Agricultural Fasteners see separate section on pages 246 to 255

COTTER PINS GOUPILLES

UTILITY ASSORTMENT

No. 020-313

This Assortment of 1,000 Cotter Pins, in 10 popular sizes packed in individual compartments. Container is sturdy fibreboard with a hinged lid. All bright plated.



020-313

UTILITY ASSORTMENT

No. 020-343

This assortment contains 195 large size Cotter Pins – 9 sizes from 5/32" x 2" to 3/8" x 3". Packed in a sturdy fibreboard container each size in an individual compartment. Useful for Agricultural and Construction Equipment. All bright plated.



020-343

MASTER ASSORTMENT

No. 020-618

Contains 1230 Plated Cotter Pins, 20 sizes from 1/16" x 1/2" to 3/16" x 2". Packed in a metal, hinged lid box with moulded plastic compartments. Retail codes shown on lid label. Size: 9-3/4" W x 13-3/4" L x 2" D.



020-618

SUPER SERVICE ASSORTMENT

No. 020-805

Contains 3345 Plated Cotter Pins and Throttle Rod Retainers – 32 items. Large size, rigid metal box with high-strength plastic compartments. Large Size: 12" W x 18" L x 3" D.

For more details see page 10.



020-805

**HAMMER-LOCK COTTER PINS
GOUPILLES 'HAMMER-LOCK'**

167
Series

These Cotter Pins spread automatically when hit with a hammer. The shorter shank rides over the up-turned point of the longer and locks rigidly. Twisting with a screwdriver returns pin to its original position. May also be used as standard Cotter Pins if desired.

ORDER BY STOCK NUMBER

Standard Package: 100 Pieces

Inserting		Locking		Unlocking		← Length →
Stock No.	Size Dia. x Length	Stock No.	Size Dia. x Length	Stock No.	Size Dia. x Length	
167-045	1/16 x 3/4	167-091	3/32 x 1	167-148	1/8 x 2	
167-047	1/16 x 1	167-095	3/32 x 1-1/2	167-171	5/32 x 1-1/2	
167-051	1/16 x 1-1/2	167-141	1/8 x 1	167-174	5/32 x 2	
167-089	3/32 x 3/4	167-145	1/8 x 1-1/2	-	-	

UTILITY ASSORTMENT

No. 020-314

Contains 800 Cotter Pins in the 10 popular sizes listed above. Each size is in an individual compartment in the sturdy fibreboard container. All bright plated.

020-314



**BRASS COTTER PINS
GOUPILLES LAITON**

168
Series

Papco[®] Brass Cotter Pins are used for marine applications, electrical and carburetor work.

ORDER BY STOCK NUMBER

Standard Package: 100 Pins

Stock No.	Size Dia. x Length	Stock No.	Size Dia. x Length	
168-106	3/64 x 3/8	168-316	3/32 x 1	
168-212	1/16 x 3/4	168-324	3/32 x 1-1/2	
168-216	1/16 x 1	168-416	1/8 x 1	
168-224	1/16 x 1-1/2	168-424	1/8 x 1-1/2	
168-312	3/32 x 3/4	168-432	1/8 x 2	

UTILITY ASSORTMENT

No. 020-322

This assortment contains 500 Brass Cotter Pins, 50 each of 10 stock sizes. Packed in individual compartments in sturdy metal-edge fibreboard box.

020-322



CLEVIS YOKES JOUGS DE CHAPE

**255
Series**

Papco® Clevis Yokes are supplied in five sizes to service all popular cars and trucks. A Yoke Assembly includes the Yoke, Clevis Pin and Cotter Pin. Standard package consists of 6 Clevis Yoke Assemblies.

Drop forged. UNF Fine Thread.

ORDER BY STOCK NUMBER

Standard Package: 6 Assemblies

Stock No.	Size Chart					Used with S.A.E. Standard Pins		• DROP FORGED UNF FINE THREAD (T)
	G	A	T	E	F	Clevis Pins	Cotter Pins	
255-026	1/4	2	1/4	9/32	5/8	255-244	1/16 x 1/2	
255-027	5/16	2-1/4	5/16	11/32	3/4	255-226	3/32 x 1/2	
255-028	3/8	2-1/2	3/8	7/16	7/8	255-236	3/32 x 3/4	
255-029	7/16	2-7/8	7/16	1/2	1	255-241	3/32 x 1	
255-030	1/2	3	1/2	9/16	1	255-245	1/8 x 1	

UNIVERSAL CLEVIS PINS PLATED GOUPILLES DE CHAPE UNIVERSELLES PLAQUÉ

**255
Series**

Each diameter has multiple Cotter Pin holes to provide wide range of grip lengths. Reduces the number of pins required for emergency coverage for cars, trucks and farm implements.

ORDER BY STOCK NUMBER

Standard Package: 6 Pins

Stock No.	Dia. x Length	Stock No.	Dia. x Length	
255-044	1/4 x 2	255-084	1/2 x 2	
255-054	5/16 x 2	255-086	1/2 x 3	
255-064	3/8 x 2	255-106	5/8 x 3	
255-074	7/16 x 2	255-126	3/4 x 3	
255-076	1/2 x 3	-	-	

UTILITY ASSORTMENT

No. 020-329

Contains 24 Universal Clevis Pins in 6 popular sizes. Packed in a sturdy fibreboard container.



020-329

GARAGE ASSORTMENT

No. 020-061

Contains 5 each of 255-044, 054, 064 Universal Clevis Pins. Each size in an individual compartment in a rigid plastic box.



020-061

UNIVERSAL CLEVIS PINS GOUPILLES DE CHAPE UNIVERSELLES

Convenient skin-packed card contains one Universal Clevis Pin and one Hitch Pin Clip.

ORDER BY STOCK NUMBER

Card No.	Size	Hitch Pin Clip	Card No.	Size	Hitch Pin Clip	
255-171	1/4 x 2	255-303	255-179	1/2 x 2	255-303	
255-173	5/16 x 2	255-303	255-180	1/2 x 3	255-303	
255-175	3/8 x 2	255-307	255-182	5/8 x 3	255-307	
255-177	7/16 x 2	255-311	255-185	3/4 x 3	255-311	
255-178	1/2 x 3	255-311	-	-	-	

SUPER SERVICE ASSORTMENT

No. 020-816

Contains 173 Standard and Universal Clevis Pins and Clips — 40 items.

Large size, rigid metal box with high-strength plastic compartments. Size: 12" W x 18" L x 3" D.

For more details see page 10.



020-816

**CLEVIS PINS BARE
GOUPILLES DE CHAPE NU**

255
Series

ORDER BY STOCK NUMBER

Standard Package: 25 Pieces

Stock No.	Dia. x Length	Stock No.	Dia. x Length	Stock No.	Dia. x Length	Stock No.	Dia. x Length
255-221	3/16 x 5/8	255-228	5/16 x 1-1/4	255-236*	3/8 x 1-3/32	255-244	7/16 x 1-3/4
255-224*	1/4 x 51/64	255-208	5/16 x 1-1/2	255-237	3/8 x 1-1/4	255-251	1/2 x 1-1/4
255-225	1/4 x 1	255-230	5/16 x 1-9/16	255-238	3/8 x 1-3/8	255-245*	1/2 x 1-27/64
255-203	5/16 x 3/4	255-231	5/16 x 1-3/4	255-239	3/8 x 1-1/2	255-246	1/2 x 1-1/2
255-226*	5/16 x 31/32	255-213	3/8 x 7/8	255-241*	7/16 x 1-15/64	255-248	1/2 x 2
255-205	5/16 x 1-1/8	255-235	3/8 x 1	255-242	7/16 x 1-1/2	-	-

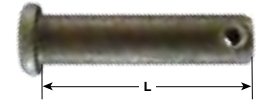

Lengths shown are from under head to end of pin.

*Used with S.A.E. Standard Clevis Yokes.

GARAGE ASSORTMENT

No. 020-062

Contains 41 Clevis Pins, all popular sizes.



020-062

MASTER ASSORTMENT

No. 020-641

This well-balanced assortment is packed in a sturdy, welded, metal box with moulded plastic compartments. Each size of Clevis Pin is in an individual compartment. Complete specifications are shown on the grease-resistant lid label.



020-641

**HITCH PIN CLIPS
AGRAFES POUR GOUPILLE D'ATTELAGE**

Papco[®] Hitch Pin Clips are made of oil-tempered spring steel wire and are bright plated. Used on agricultural implements, lawn mowers, snowmobiles, construction and automotive equipment.

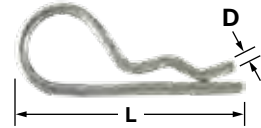

ORDER BY STOCK NUMBER

Standard Package: 25 Pieces

Stock No.	Nominal Wire Diameter 'D'	Overall Length 'L'	Fit Shaft Diameters		I.D. of Eye
			Minimum	Maximum	
255-326	1/32	7/16	7/64	9/64	5/16
255-321	3/64	5/8	1/8	3/16	1/8
255-325	5/64	1-3/32	5/16	3/8	9/64
255-313	3/32	1-3/16	1/4	3/8	1/4
255-303	3/32	1-5/8	1/4	1/2	5/16
255-307	3/32	2-5/16	1/4	5/8	5/8
255-314	3/32	2-1/2	3/8	3/4	7/16
255-316	1/8	1-3/4	1/2	3/4	7/16
255-311	1/8	2-9/16	7/16	3/4	7/16
255-309	5/32	3-5/16	3/4	1-1/8	3/4
255-310	5/32	2-15/16	5/8	1	3/4
255-306	3/16	3-1/4	5/8	1	7/8
255-308	3/16	3-3/4	7/8	1-1/4	7/8
255-319	1/4	4-3/8	1	1-1/2	3/4
255-320	5/16	3-15/16	1	1-1/2	7/8

GARAGE ASSORTMENT

No. 020-073

Contains 40 Hitch Pin Clips, 6 sizes. Packed in a clear plastic box.



020-073

UTILITY ASSORTMENT

No. 020-338

Contains 105 Hitch Pin Clips, 8 sizes. Packed in a sturdy, fibreboard container with individual compartments.



020-338

SLOTTED SPRING PINS GOUPILLES RESSORT FENDUE

300
Series

These high-carbon spring steel pins replace dowel pins, straight pins, taper and groove pins. They can be driven into an ordinary drilled hole and will hold position due to their spring action - no peening or riveting. Re-usable - easy to insert and remove. Shock resistant, vibration proof - stronger than solid pins. Spring pins are oversize, they contract when inserted in the nominal size drill hole.

ORDER BY STOCK NUMBER

Standard Package: Contains 50 Pins

Stock No.	Nominal Dia. x Length	Stock No.	Nominal Dia. x Length	Stock No.	Nominal Dia. x Length	Stock No.	Nominal Dia. x Length
300-038	1/16 x 3/16	300-091	3/32 x 1	300-189	3/16 x 1/2	300-313	1/4 x 1-1/2
300-040	5/16	300-093	1-1/4	300-190	5/8	300-315	1-3/4
300-043	1/2	300-095	1-1/2	300-191	3/4	300-316	2
300-044	5/8	300-134	1/8 x 3/8	300-193	1	300-317	2-1/4
300-045	3/4	300-137	1/2	300-195	1-1/4	300-318	2-1/2
300-046	7/8	300-138	5/8	300-197	1-1/2	300-442	5/16 x 3/4
300-047	1	300-139	3/4	300-199	1-3/4	300-443	7/8
300-059	5/64 x 1/4	300-140	7/8	300-200	2	300-444	1
300-063	1/2	300-141	1	300-201	2-1/4	300-448	1-1/2
300-064	9/16	300-143	1-1/4	300-247	7/32 x 5/8	300-450	1-3/4
300-065	3/4	300-145	1-1/2	300-252	1-1/4	300-451	2
300-067	1	300-147	1-3/4	300-253	1-3/8	300-453	2-1/2
300-069	1-1/4	300-148	2	300-254	1-1/2	300-487	3/8 x 3/4
300-071	1-1/2	300-163	5/32 x 1/2	300-256	1-3/4	300-489	1
300-084	3/32 x 5/16	300-164	5/8	300-306	1/4 x 5/8	300-493	1-1/2
300-087	1/2	300-165	3/4	300-307	3/4	300-496	2
300-088	5/8	300-167	1	300-308	7/8	300-498	2-1/2
300-089	3/4	300-169	1-1/4	300-309	1	300-500	3
300-090	7/8	300-171	1-1/2	300-311	1-1/4		



SPRING PIN ASSORTMENTS ASSORTIMENTS DE GOUPILLES RESSORT

Automotive uses include drive shaft coupling pins, gear shift lever pins, pump shaft pins, window regulator pins, door handle retaining pins, automatic transmission pins, etc. Also used in Agricultural Machinery and Farm equipment.

UTILITY ASSORTMENT

No. 020-319

Contains 116 pins, 12 sizes. Packed in a sturdy fibre board box with illustrated lid label showing retail price codes.

020-319



MASTER ASSORTMENT

No. 020-642

Contains 275 Pins, 20 popular sizes in a metal box with moulded plastic compartments, hinged lid, carrying handle and safety snap lock. Useful for construction and farm equipment dealers. Size: 9-3/4" W x 13-3/4" L x 2" D.

020-642



SUPER SERVICE ASSORTMENT

No. 020-819

Contains 770 Spring Pins - 32 sizes. Large size, rigid metal box with high-strength plastic compartments. Size: 12" W x 18" L x 3" D.

020-819



For more details see page 10.

**TAPER PINS
GOUPILLES CONIQUE**

312
Series



Standard Taper 1/4" per foot or .0208" per inch. Diameter is measured at the large end.

ORDER BY STOCK NUMBER

Standard Package: 25 Pieces

Stock No.	Dia. x Length	Dia. Large End.	Approximate Dia.	Stock No.	Dia. x Length	Dia. Large End.	Approximate Dia.
312-001	00 x 1"	.141	9/64	312-014	4 x 1-1/2"	.250	1/4
312-002	00 x 1-1/2"	.141	9/64	312-015	4 x 2"	.250	1/4
312-003	0 x 1"	.156	5/32	312-016	4 x 2-1/2"	.250	1/4
312-004	0 x 1-1/2"	.156	5/32	312-017	5 x 1-1/2"	.289	19/64
312-005	1 x 1"	.172	11/64	312-018	5 x 1-3/4"	.289	19/64
312-006	1 x 1-1/2"	.172	11/64	312-019	5 x 2"	.289	19/64
312-007	1 x 2"	.172	11/64	312-020	5 x 2-1/2"	.289	19/64
312-008	2 x 1-1/4"	.193	3/16	312-021	6 x 2"	.341	11/32
312-009	2 x 1-1/2"	.193	3/16	312-022	6 x 2-1/2"	.341	11/32
312-010	2 x 2"	.193	3/16	312-023	6 x 3"	.341	11/32
312-011	3 x 1-1/4"	.219	7/32	312-024	7 x 2-1/2"	.409	13/32
312-012	3 x 1-1/2"	.219	7/32	312-025	7 x 3"	.409	13/32
312-013	3 x 2"	.219	7/32				

Taper Pins Sizes No. 7/10 to No. 10 can be supplied.

GARAGE ASSORTMENT

No. 020-050

Contains 46 Taper Pins. 18 sizes from 312-001 to 020. Needed in every garage. Packed in plastic box.

020-050



GARAGE ASSORTMENT

No. 020-051

For farm Equipment use. Contains 36 Taper Pins. 10 sizes from 312-014 to 025. These large size pins are for Tractor and Farm Implement use. Combine with assortment no. 020-050 for complete coverage.

020-051



MASTER ASSORTMENT

No. 020-610

Contains 100 Taper Pins 20 sizes from 2/0 x 1" to No. 6 x 3". Packed in an all metal container with hinged lid and carrying handle.

020-610



RODS AND SHAPES

BAGUETTES ET FORMES

THREADED RODS

COUPLING NUTS

RODS

- ROUND STEEL
- ROUND & SQUARE ALUMINUM

FLATS

- STEEL
- ALUMINUM
- SLOTTED GALVANIZED

ANGLES

- STEEL
- ALUMINUM
- SLOTTED GALVANIZED

ROUND & SQUARE TUBING

- STEEL
- ALUMINUM

SHEETS

- COLD ROLLED
- GALVANIZED
- ALUMINUM
- EXPANDED METAL

141 Series



These continuous threaded rods are made of cold drawn steel and are zinc plated or bare metal. Can be bent to shape without heating. Very useful in machine shops, garages, and for general maintenance. Used to make eye bolts, stud bolts, anchor bolts and for suspending equipment from ceilings, mountings on walls, etc. Just cut to length and use.

ORDER BY STOCK NUMBER Tensile strength up to 5/8": 64,000 p.s.i. (min.) up to 3/4": 55,000 p.s.i. (min.)

Length Dia.	Inch Sizes				Metric Sizes							
	36		12	Standard Package	36			Standard Package	Length Dia.	1 metre	300 mm	Standard Package
Plated	Bare	Plated	Dia.		Plated	Bare	Plated		Plated	Plated		
1/4-20	141-314	141-354	141-204	25	5/8-11	141-324	141-364	5	M6	141-706	141-606	10
5/16-18	141-316	141-356	141-206	20	3/4-10	141-326	141-366	5	M8	141-708	141-608	10
3/8-16	141-318	141-358	141-208	15	7/8-9	141-328	141-368	3	M10	141-710	141-610	10
7/16-14	141-320	141-360	-	10	1-8	141-330	141-370	3	M12	141-712	141-612	5
1/2-13	141-322	141-362	141-212	10	-	-	-	-	-	-	-	-

Threaded Rods from 1/4-20 to 1-8 available in 6, 10 and 12 foot lengths.

For Stainless Steel Threaded Rods see page 234.

B7 HIGH-STRENGTH UNI-RODS[®]
HAUTE RÉSISTANCE B7 UNI-RODS[®]

Yellow Gold Zinc Dichromate Plated B7 Alloy Steel



High strength continuous threaded rod to ASTM A-193 B7 Specification. Heat treated. Chrome-moly steel, tensile strength exceeds 125,000 p.s.i. Used for vehicles, construction, mining, chemical and petroleum equipment. Temperature service range from -150°F to +850°F. UNC coarse thread or UNF fine thread.

ORDER BY STOCK NUMBER

UNC Stock No.	UNF Stock No.	Size	Standard Package	UNC Stock No.	UNF Stock No.	Size	Standard Package	UNC Stock No.	UNF Stock No.	Size	Standard Package
141-550	141-570	1/4 x 36	5	141-553	141-573	7/16 x 36	2	141-557	141-577	3/4 x 36	2
141-551	141-571	5/16 x 36	4	141-554	141-574	1/2 x 36	2	141-558	141-578	7/8 x 36	1
141-552	141-572	3/8 x 36	3	141-556	141-576	5/8 x 36	2	141-559	141-579	1 x 36	1

HEX COUPLING NUTS
ÉCROUS DE RACCORD

Plated hexagon steel nuts for joining or adjusting Threaded Rods.



ORDER BY STOCK NUMBER

Stock No.	Dia.	Dimensions	Standard Package	Stock No.	Dia.	Dimensions	Standard Package
141-914	1/4-20	7/16 x 7/8	50	141-924	5/8-11	15/16 x 2-1/8	15
141-916	5/16-18	1/2 x 1-3/4	25	141-926	3/4-10	1-1/8 x 2-1/4	15
141-918	3/8-16	9/16 x 1-3/4	25	141-928	7/8-9	1-1/4 x 2-1/2	10
141-920	7/16-14	5/8 x 1-3/4	25	141-930	1-8	1-1/4 x 2-1/2	10
141-922	1/2-13	3/4 x 1-3/4	25	<i>Dimensions: width across flats x length</i>			

**STEEL CENTRE
CENTRE DE L'ACIER
MERCHANDISER
PRÉSENTOIR**

(For empty Steel Centre Floor Stand order No. 022-014)

No. 022-008

Basic stock for automotive, industrial, farm and hardware
This sturdy merchandiser holds 16 sizes of bare metal construction grade steel. Contains the right selection of flats, round and angles needed in daily repairs. Steel can be cut, bent, drilled and welded as required. All items handy 36" length.

- Wide range of steel for general repairs.
- Sturdy, all-metal floor stand.
- Retail price labelled.
- Can hold parts bins for fasteners, etc.
- Size 24-1/2" W x 13-1/2" D x 24" H
- Shipping weight with stock 100 pounds.
- Contains 52 steel shapes - one standard package of each size.

022-008



**Bare Metal Steel, Aluminum Rods and Shapes
ORDER BY STOCK NUMBER**

36" Long				36" Long * 48" Long											
Stock No.	Size	Std. Pkg.	Wt. Ea. ◊	Stock No.	Size	Std. Pkg.	Wt. Ea. ◊	Stock No.	Size	Std. Pkg.	Wt. Ea. ◊	Stock No.	Size	Std. Pkg.	Wt. Ea. ◊
Steel Round Rods				Aluminum Round Rods				Steel Flats				Aluminum Flats			
142-004	1/4 Dia.	5	0.5	142-808	3/8 Dia.	3	0.4	142-040	1/8 x 3/4	3	1.0	142-640	1/8 x 3/4	3	0.3
142-006	5/16 Dia.	5	0.8	142-812	1/2 Dia.	3	0.7	142-042	1/8 x 1	3	1.2	142-642	1/8 x 1	3	0.4
142-008	3/8 Dia.	5	1.1	142-814	5/8 Dia.	2	1.1	142-044	1/8 x 1-1/4	3	1.6	142-646	1/8 x 1-1/2	3	0.6
142-012	1/2 Dia.	5	2.0	Aluminum Square Rods				142-046	1/8 x 1-1/2	3	2.0	142-648	1/8 x 2	3	0.9
142-014	5/8 Dia.	5	3.1	142-846	1/2 Dia.	3	0.9	142-060*	1/8 x 3/4	3	1.1	142-660	1/8 x 3/4	3	0.4
142-016	3/4 Dia.	3	4.1	-	-	-	-	142-068*	1/8 x 2	3	2.7	142-662	1/8 x 1	3	0.6
-	-	-	-	-	-	-	-	Slotted Steel Flats Galvanized				-	-	-	-
-	-	-	-	-	-	-	-	142-220	1-3/8 x .074	5	0.8	-	-	-	-
-	-	-	-	-	-	-	-	142-222*	1-3/8 x .074	5	1.2	-	-	-	-
36" Long * 48" Long				36" Long											
Stock No.	Size	Std. Pkg.	Wt. Ea. ◊	Stock No.	Size	Std. Pkg.	Wt. Ea. ◊	Stock No.	Size	Std. Pkg.	Wt. Ea. ◊	Stock No.	Size	Std. Pkg.	Wt. Ea. ◊
Steel Angles				Aluminum Angles				Steel Tubing				Aluminum Tubing			
142-100	1/8 x 3/4	3	1.8	142-700	1/8 x 3/4	3	0.6	142-302	3/4 Sq.	2	1.7	142-430	3/4 Sq.	3	0.5
142-102	1/8 x 1	3	2.4	142-702	1/8 x 1	3	0.8	142-304	1 Sq.	2	3.9	142-432	1 Sq.	3	0.6
142-104	1/8 x 1-1/4	3	3.0	142-706	1/8 x 1-1/2	3	1.2	142-402	3/4 Rd.	2	1.3	142-338	3/4 Rd.	3	0.4
142-106	1/8 x 1-1/2	3	3.7	142-708	1/8 x 2	3	1.6	142-404	1 Rd.	2	3.1	142-340	1 Rd.	3	0.5
142-126*	1/8 x 1-1/2	3	4.1	142-720	1/16 x 3/4	3	0.4	-	-	-	-	-	-	-	-
Slotted Steel Angles Galvanized				142-778	1/16 x 3/4	3	0.3	-	-	-	-	-	-	-	-
142-200	.074 x 1-1/2	3	1.7	142-780	1/16 x 1	3	0.4	-	-	-	-	-	-	-	-
142-202*	.074 x 1-1/2	3	2.5	142-790	1/16x1/2x3/4	3	0.2	-	-	-	-	-	-	-	-

Included in Steel Centre Merchandiser No. 022-008.

Note: 3/4 Steel Tubing wall = .065, 1" = .100
3/4 and 1" Aluminum Tubing wall = .050

◊ lbs.

**METAL MARKET MERCHANDISER
PRÉSENTOIR MARCHÉ DU MÉTAL**

No. 022-032

Master stock of construction grade steel for automotive, industrial, farm, hardware and home.

Cold rolled steel sheets, galvanized steel, aluminum sheets and expanded metal.

Contains the right selection of flats, rounds and angles (see Merchandiser No. 022-008), plus sheets needed in daily repairs (see below).

- Can be cut, bent, formed, drilled and welded as required.
- Wide range of metal for general repairs.
- Sturdy all-metal floor stand.
- Retail labelled.
- Can hold parts bins for related fasteners
- New graphic label channel and protector guard bar a safe retail unit.
- Contains 153 steel shapes one package of each size plus 12 metal sheets.
- Size: 24" W x 22-1/2" D x 31-3/4" H
- Empty metal market display rack (022-033)



Empty Metal Market Display Rack No. 022-033

ORDER BY STOCK NUMBER

Stock No.	Size	Description	Pkg Qty
142-004	1/4 x 36	Steel Round Rods	5
142-006	5/16 x 36	Steel Round Rods	5
142-008	3/8 x 36	Steel Round Rods	5
142-012	1/2 x 36	Steel Round Rods	5
142-014	5/8 x 36	Steel Round Rods	5
142-016	3/4 x 36	Steel Round Rods	3
142-040	1/8 x 3/4 x 36	Flat Steel	3
142-042	1/8 x 1 x 36	Flat Steel	3
142-044	1/8 x 1-1/4 x 36	Flat Steel	3
142-046	1/8 x 1-1/2 x 36	Flat Steel	3
142-060	1/8 x 3/4 x 48	Flat Steel	3
142-068	1/8 x 2 x 48	Flat Steel	3
142-100	1/8 x 3/4 x 36	Steel Angle	3
142-102	1/8 x 1 x 36	Steel Angle	3
142-104	1/8 x 1-1/4 x 36	Steel Angle	3
142-106	1/8 x 1-1/2 x 36	Steel Angle	3
142-126	1/8 x 1-1/2 x 48	Steel Angle	3
142-200	.074 x 1-1/2 x 36	Slotted Steel Angle Galv.	3
142-202	.074 x 1-1/2 x 48	Slotted Steel Angle Galv.	3
142-220	1-3/8 x .074 x 36	Slotted Steel Flats Galv.	5
142-222	1-3/8 x .074 x 48	Slotted Steel Flats Galv.	5
142-302	3/4 x .065 x 36	Square Steel Tubing	2
142-304	1 x .065 x 36	Square Steel Tubing	2
142-338	3/4 x 3'	Aluminum Round Tubing	3
142-340	1 x 3'	Aluminum Round Tubing	3
142-402	3/4 x .065 x 36	Round Steel Tubing	2
142-404	1 x .065 x 36	Round Steel Tubing	2

Stock No.	Size	Description	Pkg Qty
142-430	3/4 x 36	Aluminum Square Tubing	3
142-432	1 x 36	Aluminum Square Tubing	3
142-500	36 x 24	Steel Sheet Metal (26 gauge)	2
142-520	6 x 24	Steel Sheet Metal (22 gauge)	2
142-524	8 x 24	Steel Sheet Metal (24 gauge)	2
142-528	24 x 8 x .025	Steel Sheet Metal (24 gauge)	2
142-550	8 x 24	Aluminum Sheet Metal	2
142-560	1/2 x 24 x 24	Expanded Steel Metal	1
142-570	3/4 x 24 x 24	Expanded Steel Metal	1
142-640	1/8 x 3/4 x 3'	Aluminum Flats	3
142-642	1/8 x 1 x 3'	Aluminum Flats	3
142-646	1/8 x 1-1/2 x 3'	Aluminum Flats	3
142-648	1/8 x 2 x 3'	Aluminum Flats	3
142-660	1/8 x 3/4 x 4'	Aluminum Flats	3
142-662	1/8 x 1 x 4'	Aluminum Flats	3
142-700	1/8 x 3/4 x 3'	Aluminum Angles	3
142-702	1/8 x 1 x 3'	Aluminum Angles	3
142-706	1/8 x 1-1/2 x 3'	Aluminum Angles	3
142-708	1/8 x 2 x 3'	Aluminum Angles	3
142-720	1/16 x 3/4 x 4'	Aluminum Angles	3
142-778	1/16 x 3/4 x 3'	Aluminum Angles	6
142-780	1/16 x 1 x 3'	Aluminum Angles	3
142-790	1/16 x 1/2 x 3/4 x 3'	Aluminum Angles	3
142-808	3/8 x 3'	Aluminum Round Rods	3
142-812	1/2 x 3'	Aluminum Round Rods	3
142-814	5/8 x 3'	Aluminum Round Rods	2
142-846	1/2 x 3'	Aluminum Square Rods	3

SHEET STEEL TÔLES D'ACIER

ORDER BY STOCK NUMBER

Stock No.	Size	Description	Standard Package	Weight lbs.
142-524	8 x 24	22 Ga. Cold Rolled Steel Sheet	2	1.7
142-528	12 x 24	22 Ga. Cold Rolled Steel Sheet	2	2.5
142-495	12 x 24	26 Ga. Galvanized Sheet	2	1.8
142-551	12 x 24	.025 Aluminum Sheet	2	0.7
142-558	12 x 24	1/2 Expanded Metal	2	2.9
142-568	12 x 24	3/4 Expanded Metal	2	1.7
142-200	1-1/2 x 36	.074 Slotted Angles	3	2.1
142-202	1-1/2 x 48	.074 Slotted Angles - Galvanized	3	4.8
142-204	1-1/2 x 72	.074 Slotted Angles - Galvanized	3	7.8
142-220	1-3/8 x 36	.074 Slotted Flats - Galvanized	3	2.4
142-222	1-3/8 x 48	.074 Slotted Flats - Galvanized	3	3.6

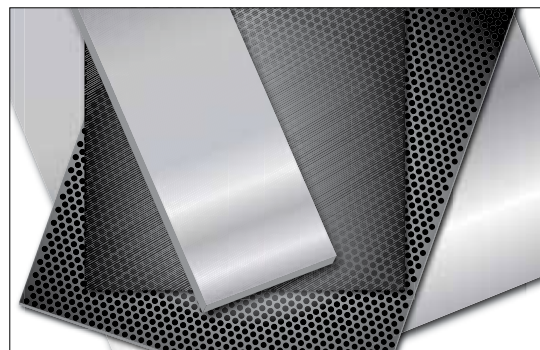

Warning: DO NOT weld galvanized metal as toxic fumes may be present.

UNI-ROD® MERCHANDISERS PRÉSENTOIRS UNI-ROD®

Features a heavy-duty, labelled steel floor stand to display and sell threaded rods, coupling nuts, washers, etc. For empty Threaded Rod Floor Stand order 022-014 Bins NOT included. For Plastic Bins No. 022-040 see page 16.

No. 022-010

Plated Uni-Rods®, Coupling Nuts metal Merchandiser with six service bins

36" Threaded Rods				Coupling Nuts			
25	1/4 Rods	10	1/2 Rods	50	1/4 Nuts	25	1/2 Nuts
20	5/16	5	5/8	25	5/16	15	5/8
15	3/8	5	3/4	25	3/8	15	3/4

022-010

No. 022-011

Plated Uni-Rods® with metal Merchandiser

36" Threaded Rods			
25	1/4 x 36" Plated Rods	10	1/2 x 36" Plated Rods
20	5/16	5	5/8
15	3/8	5	3/4

No. 022-012

Bare metal Uni-Rods® with metal Merchandiser

36" Threaded Rods			
25	1/4 x 36" Bare Rods	10	1/2 x 36" Bare Rods
20	5/16	5	5/8
15	3/8	5	3/4



24-1/2"W x 13-1/2"D x 24"H

No. 022-013

Plated Threaded Rods, Hex Nuts, Washers, Hex Coupling Nuts

Deluxe Display with metal Merchandiser and 18 service bins. Complete coverage.											
Threaded Rods			Hex Nuts			S.A.E. Washers			Hex Coupling Nuts		
25	1/4	141-314	200	1/4	083-014	200	1/4	154-014	50	1/4	141-914
20	5/16	141-316	200	5/16	083-016	200	5/16	154-016	25	5/16	141-916
15	3/8	141-318	200	3/8	083-018	200	3/8	154-018	25	3/8	141-918
10	1/2	141-322	100	1/2	083-022	200	1/2	154-022	25	1/2	141-922
5	5/8	141-324	50	5/8	083-024	100	5/8	154-024	15	5/8	141-924
5	3/4	141-326	50	3/4	083-026	100	3/4	154-026	15	3/4	141-926

For ASSORTMENT No. 020-900 of Threaded Rods please refer to page 11.

NOTES

Lined area for notes.

WASHERS

RONDELLES



FLAT STEEL WASHERS

S.A.E. WASHERS

LOCK WASHERS:

- **SPRING**
- **EXTRA DUTY**
- **HI-COLLAR**
- **TOOTH**

FIBRE WASHERS

FENDER WASHERS

MACHINERY BUSHINGS

BRASS WASHERS

COPPER WASHERS

SPACER WASHERS

TENSION WASHERS

FINISHING WASHERS



PLAIN STEEL WASHERS RONDELLES ORDINAIRES

- 143**
1 Lb.
Bare
- 144**
5 Lbs.
Bare
- 145**
100's
Bare
- 146**
1 Lb.
Plated
- 148**
100's
Plated

(U.S.S. Wrought Washers)

Papco® Flat Washers are free from burrs and have smooth, flat surfaces.



ORDER BY STOCK NUMBER

Standard Package: as indicated

Stock No.					100's Std. Pkg.	Bolt Size	Hole Dia.	Outside Dia.	Thickness	Approx. No. Per lb.
1 lb. Bare (454 g)	5 lbs. Bare (2.2 Kg)	100's Bare	1 lb Plated (454 g)	100's Plated						
143-010	144-010	145-010	146-010	148-010	100	3/16	1/4	9/16	3/64	294
143-014	144-014	145-014	146-014	148-014	100	1/4	5/16	3/4	1/16	162
143-016	144-016	145-016	146-016	148-016	100	5/16	3/8	7/8	1/16	96
143-018	144-018	145-018	146-018	148-018	100	3/8	7/16	1	5/64	75
143-020	144-020	145-020	146-020	148-020	50	7/16	1/2	1-1/4	3/32	38
143-022	144-022	145-022	146-022	148-022	50	1/2	9/16	1-3/8	7/64	27
143-023	144-023	145-023	146-023	148-023	25	9/16	5/8	1-1/2	7/64	23
143-024	144-024	145-024	146-024	148-024	25	5/8	11/16	1-3/4	9/64	13
143-026	144-026	145-026	146-026	148-026	20	3/4	13/16	2	9/64	9
143-028	144-028	145-028	146-028	148-028	20	7/8	15/16	2-1/4	5/32	7
143-030	144-030	145-030	146-030	148-030	20	1	1-1/16	2-1/2	5/32	6
	144-032					1-1/8	1-3/16	2-3/4	5/32	5
	144-034					1-1/4	1-5/16	2-3/4	5/32	5
	144-037					1-1/2	1-9/16	3-1/4	11/64	3

UTILITY ASSORTMENT

No. 020-352

Contains 5.5 lbs of Plain Steel Washers in bolt sizes from 3/16" to 5/8". Each size in an individual compartment. Packed in a sturdy fibreboard container. All bright plated.

020-352



MASTER ASSORTMENT

No. 020-620

Contains over 1615 Plain Steel Washers 10 sizes from 1/8" to 3/4". Packed in a metal divided box with hinged lid, carrying handle, positive lock and illustrated label showing retail price codes. All bright plated.

020-620



For Super Service Assortment No. 020-804 of Plain Steel, S.A.E. and Lock Washers see page 95.

S.A.E. WASHERS RONDELLES S.A.E.



S.A.E. Steel Washers are made from strip steel; have bright, smooth, flat surfaces; are highly polished and are free from burrs.

ORDER BY STOCK NUMBER

Standard Package: as indicated

Stock No.			100's Std. Pkg.	Bolt Size	Inside Dia.	Outside Dia.	Thickness	Approx. No. Per lb.
1 lb. Bare (454 g)	100's Bare	100's Plated						
149-008		154-006	100	# (1/8)	5/32	3/8	3/64	800
149-010		154-008	100	# 8	3/16	7/16	3/64	550
149-014	151-010	154-010	100	# 10 (3/16)	7/32	1/2	1/16	350
149-016	151-014	154-014	100	1/4	9/32	5/8	1/16	225
149-018	151-016	154-016	100	5/16	11/32	11/16	1/16	200
149-018	151-018	154-018	100	3/8	13/32	13/16	1/16	140
149-020	151-020	154-020	50	7/16	15/32	59/64	1/16	105
149-022	151-022	154-022	50	1/2	17/32	1-1/16	3/32	55
149-023	151-023	154-023	25	9/16	19/32	1-3/16	3/32	45
149-024	151-024	154-024	25	5/8	21/32	1-5/16	3/32	36
149-026	151-026	154-026	20	3/4	13/16	1-1/2	1/8	22
149-028	151-028	154-028	20	7/8	15/16	1-3/4	1/8	16
149-030	151-030	154-030	20	1	1-1/16	2	1/8	12

SMALL SIZE S.A.E. WASHERS GARAGE ASSORTMENT

No. 020-031

Contains 400 pieces, 6 sizes no. 2 to 1/4" dia. For Electrical, Radio and Electronic use. Packed in a transparent plastic box.

020-031



PLATED UTILITY ASSORTMENT

No. 020-341

Contains 370 S.A.E. Washers in sizes from 3/16" to 5/8". Each size is in an individual compartment in a sturdy fibreboard container.

020-341



PLATED MASTER ASSORTMENT

No. 020-619

Contains 1200 S.A.E. Washers, 12 sizes from 1/8" to 1". Packed in a metal, divided box with hinged lid, carrying handle, positive lock and illustrated lid label showing retail price codes.

020-619



For Super Service Assortment No. 020-804 of Plain Steel, S.A.E. and Lock Washers see page 95.

Size:
9-3/4" W x 13-3/4" L x 2" D

SPRING LOCK WASHERS RONDELLES RESSORT

High Carbon Spring Steel - Plain Type - Non-Linking

REGULAR LOCK WASHERS RONDELLES À RESSORT ORDINAIRES

155
100's
Bare

156
1000's
Bare

157
100's
Plated



Papco® Lock Washers provide a locking spring action against the tendency of threaded assemblies loosening due to vibration. They are made to specifications of the Society of Automotive Engineers (S.A.E.) and the current ANSI B27.1 standard. They are supplied in Regular, for Grade 2 bolts and low load applications; Extra Duty for Grade 5 or 8 bolts and high load applications; and Hi-Collar for Socket Head Cap Screws.

Standard Package: 100's - up to 1 - 100; 1-1/8 - 1-1/4 - 50; 1-1/2 - 25.
1000's - up to - 7/16 - 1000; 1/2 to 5/8 - 500; 3/4 - 250.

ORDER BY STOCK NUMBER

Stock No.			Bolt Size	Steel Section W x T	Stock No.			Bolt Size	Steel Section W x T
100's Bare	1000's Bare	100's Plated			100's Bare	1000's Bare	100's Plated		
155-006	156-006		No. 6 (1/8)	.047 x .031	155-023	156-023	157-023	9/16	.188 x .141
155-008	156-008		No. 8 (5/32)	.055 x .040	155-024	156-024	157-024	5/8	.203 x .156
155-010	156-010	157-010	No. 10 (3/16)	.062 x .047	155-026	156-026	157-026	3/4	.234 x .188
155-012	156-012	157-012	No. 12 (7/32)	.070 x .056	155-028		157-028	7/8	.266 x .219
155-014	156-014	157-014	1/4	.109 x .062	155-030		157-030	1"	.297 x .250
155-016	156-016	157-016	5/16	.125 x .078	155-032			1-1/8	.328 x .281
155-018	156-018	157-018	3/8	.141 x .094	155-034			1-1/4	.359 x .312
155-020	156-020	157-020	7/16	.156 x .109	155-036			1-3/8	.391 x .344
155-022	156-022	157-022	1/2	.171 x .125	155-038			1-1/2	.422 x .375

EXTRA DUTY LOCK WASHERS RONDELLES À RESSORT ROBUSTE

101
Series



Extra Duty, 4037 High Alloy Steel. For use with Grade 5 or 8 bolts and for high load applications. Mechanical Gold Zinc Dichromate Plated.

ORDER BY STOCK NUMBER

Stock No.	Bolt Size	Standard Package	Steel Section W x T	Stock No.	Bolt Size	Standard Package	Steel Section W x T
101-014	1/4	100	.109 x .062	101-026	3/4	40	.234 x .188
101-016	5/16	100	.125 x .078	101-028	7/8	40	.266 x .219
101-018	3/8	100	.141 x .094	101-030	1"	40	.297 x .250
101-020	7/16	100	.156 x .109	101-032	1-1/8	20	.411 x .375
101-022	1/2	50	.171 x .125	101-034	1-1/4	20	.452 x .417
101-023	9/16	50	.188 x .141	101-038	1-1/2	20	.526 x .496
101-024	5/8	50	.203 x .156				

HI-COLLAR LOCK WASHERS RONDELLES À RESSORT HAUTE

159
Series



High Carbon Spring Steel. For use with Socket Head Cap Screws.

ORDER BY STOCK NUMBER

Stock No.	Bolt Size	Standard Package	Steel Section W x T	Stock No.	Bolt Size	Standard Package	Steel Section W x T
159-014	1/4	100	.047 x .078	159-020	7/16	100	.090 x .140
159-016	5/16	100	.062 x .093	159-022	1/2	50	.103 x .172
159-018	3/8	100	.076 x .125	159-024	5/8	50	.125 x .203

**SPRING LOCK WASHER ASSORTMENTS
ASSORTIMENTS DE RONDELLES À RESSORT**



020-047

GARAGE ASSORTMENT

No. 020-047

Contains 235 Regular Lock Washers Plated in sizes 3/16" to 1/2". Packed in a transparent plastic box.

ASSORTMENT

No. 020-886

This popular Assortment contains 39 Lock Washers in sizes 3/16" to 1/2". Standard package contains 24 individual assortments.

All Bright Plated.



020-886

UTILITY ASSORTMENT

No. 020-339

This Assortment contains 505 Regular Lock Washers Plated in nine sizes from 3/16" to 3/4". Packed in a sturdy, fibreboard container with moulded compartments.



020-339



020-621

MASTER ASSORTMENT

No. 020-621

Contains 1257 Regular Lock Washers Plated in thirteen sizes from 1/8" to 1". Packed in a metal box with moulded plastic compartments. Hinged lid, positive lock carrying handle and illustrated lid label that shows retail price codes.

Size: 9-3/4" W x 13-3/4" L x 2" D.

**PLAIN STEEL, S.A.E.
AND LOCK WASHER
SUPER SERVICE ASSORTMENT**

No. 020-804

Contains 3020 Flat, Lock and Tooth Lock Washers in thirty two sizes. Large size metal box with high-strength moulded plastic compartments. For more details see page 10.

All Bright Plated.

Size: 12" W x 18" L x 3" D.



020-804

**PLATED TOOTH LOCK WASHERS
RONDELLES ANTI-VIBRATION PLAQUÉ**

**161
Series**

Bright Zinc Plated High Carbon Spring Steel



External Type



Countersunk Type



Internal Type

ORDER BY STOCK NUMBER

Standard Package: 100 Pieces

Stock No.	Bolt or screw size	Outside Diameter	Thickness	Stock No.	Bolt or screw size	Outside Diameter	Thickness	Stock No.	Bolt or screw size	Outside Diameter	Thickness
External Type				External Countersunk Type				Internal Type			
161-106	6 (1/8)	5/16	.018	161-306	6 (1/8)	19/64	.018	161-206	6 (1/8)	9/32	.018
161-108	8 (5/32)	3/8	.020	161-308	8 (5/32)	11/32	.018	161-208	8 (5/32)	21/64	.020
161-110	10 (3/16)	13/32	.022	161-310	10 (3/16)	3/8	.022	161-210	10 (3/16)	3/8	.022
161-114	1/4	1/2	.025	161-314	1/4	15/32	.022	161-214	1/4	15/32	.025
161-118	5/16	19/32	.030	161-318	5/16	5/8	.025	161-218	5/16	19/32	.030
161-122	7/16	25/32	.035					161-222	7/16	25/32	.035
161-124	1/2	7/8	.040					161-224	1/2	7/8	.040
161-126	9/16	31/32	.040					161-226	9/16	31/32	.040
161-128	5/8	1-1/16	.045					161-228	5/8	1-1/16	.045
161-132	3/4	1-1/4	.050					161-232	3/4	1-1/4	.050
161-134	7/8	1-7/16	.055					161-234	7/8	1-3/8	.055
161-136	1	1-5/8	.062					161-236	1"	1-5/8	.062

GARAGE ASSORTMENT INTERNAL TYPE

No. 020-034

Contains 225 Internal Type Tooth Lock Washers in six sizes from 3/16" to 1/2".



GARAGE ASSORTMENT EXTERNAL TYPE

No. 020-035

Contains 225 External Type Tooth Lock Washers in six sizes from 3/16" to 1/2".



WORK-SAVER[®] KIT FLAT AND LOCK WASHER ASSORTMENT

No. 020-207

Contains 576 pieces. Assorted sizes of Zinc Plated Flat and Lock Washers.



UTILITY ASSORTMENT

No. 020-340

Contains 900 Internal and External Tooth Lock Washers 16 sizes from No. 6 to 1/2" in both types.

Packed in a sturdy fibreboard container.



MASTER ASSORTMENT

No. 020-625

Contains 1370 Internal and External Washers. 10 external sizes from No. 6 to 3/4"; 10 internal sizes from No. 6 to 3/4". Packed in a metal container with hinged lid, carrying handle and lock.

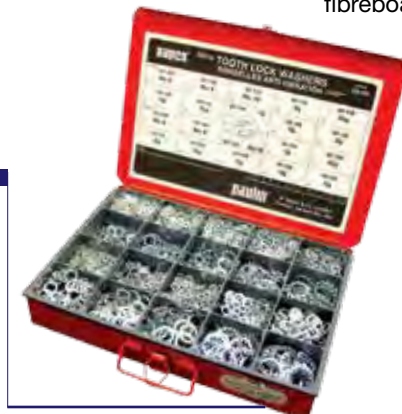

**FIBRE WASHERS
RONDELLES FIBREUSES**

**162
Series**

1/32" - TWO THICKNESSES - 1/16"



Papco[®] Fibre Washers are made from vulcanized fibre. They are suitable for generator, carburetor or fuel pump work and wherever an insulating washer or gasket is required.

ORDER BY STOCK NUMBER

Standard Package: 100 Pieces

Stock No.		Inside Dia.	Outside Dia.	Stock No.		Inside Dia.	Outside Dia.	Stock No.		Inside Dia.	Outside Dia.	Stock No.		Inside Dia.	Outside Dia.
1/32 Thick	1/16 Thick			1/32 Thick	1/16 Thick			1/32 Thick	1/16 Thick			1/32 Thick	1/16 Thick		
162-201	162-251	3/32	3/16	162-207	162-257	1/4	3/8	162-213	162-263	1/2	5/8	162-220	162-270	11/16	15/16
162-202	162-252	3/32	1/4	162-208	162-258	5/16	7/16	162-214	162-264	7/16	11/16	162-221	162-271	3/4	1"
162-203	162-253	1/8	1/4	162-209	162-259	1/4	1/2	162-215	162-265	1/2	3/4	162-223	162-273	3/4	1-1/16
162-204	162-254	1/8	5/16	162-210	162-260	3/8	1/2	162-216	162-266	5/8	3/4	162-224	162-274	13/16	1-1/8
162-205	162-255	3/16	5/16	162-211	162-261	5/16	9/16	162-218	162-268	9/16	13/16	162-225	162-275	15/16	1-1/4
162-206	162-256	3/16	3/8	162-212	162-262	3/8	5/8	162-219	162-269	5/8	7/8	162-226	162-276	7/8	1-3/16
												162-227	162-277	1"	1-5/16

For Fibre Drain Plug Gaskets see page 169



020-857

ASSORTMENT

No. 020-857

- Contains 360 Fibre Washers.
- 18 Sizes 1/16" and 1/32" thick
162-203, 206, 209, 211, 212, 214, 215, 219, 221
162-253, 256, 259, 261, 262, 264, 265, 269, 271.
- Plastic container with moulded compartments.
- Illustrated label shows sizes etc.
- Refills available in standard packages.

GARAGE ASSORTMENT

No. 020-059

This Assortment contains 130 Fibre Washers in sizes from 1/8" to 3/4".

Packed in clear, plastic box with hinged lid.



020-059

**FLAT FENDER WASHERS
RONDELLES DE PROTECTION**

**162
Series**

Used for Fender and Body work. Also two washers can be bolted together and used for Heater Hose Hole plugs.



ORDER BY STOCK NUMBER

Standard Package: 100 Pieces

Stock No.	Bolt Size	Outside Dia.	Inside Dia.	Thickness	Stock No.	Bolt Size	Outside Dia.	Inside Dia.	Thickness
162-393	3/16	1"	13/64	3/64	162-397	5/16	1-1/4	11/32	1/16
162-394	3/16	3/4	13/64	3/64	162-398	3/8	1-1/2	13/32	1/16
162-395	1/4	1-1/4	9/32	1/16	162-399	5/16	1-1/2	11/32	1/16
162-396	5/16	1"	11/32	1/16	162-400	1/2	2"	17/32	1/16

GARAGE ASSORTMENT

No. 020-057

Contains 71 Bright Plated Fender Washers for 1/4", 5/16" and 3/8" Bolts. Packed in rigid, transparent plastic container.

020-057



**MACHINERY BUSHINGS
BAGUES DE MACHINERIE**

**162
Series**

These steel repair bushings are used on Agricultural Machinery, Road Machines, Mine and Mill Equipment, Automobiles, Trucks, etc.



ORDER BY STOCK NUMBER

Standard Package: 25 Pieces

Stock No.	Shaft Dia.	Outside Dia.	Gauge	Weight Per 100 pcs.	Stock No.	Shaft Dia.	Outside Dia.	Gauge	Weight Per 100 pcs.
162-610	5/8	1-1/8	18	0.9	162-626	1-1/4	1-7/8	14	3.4
162-611			14	1.5	162-627			10	6.1
162-613	3/4	1-1/4	18	1.0	162-631	1-3/8	2-1/8	18	2.7
162-614			14	1.7	163-632			14	4.6
162-615			10	3.1	162-633			10	8.2
162-616	7/8	1-3/8	18	1.2	162-635	1-1/2	2-1/4	14	4.8
162-617			14	2.0	162-636			10	8.6
162-619	1	1-1/2	18	1.3	162-640	1-3/4	2-1/2	18	3.3
162-620			14	2.2	162-641			14	5.6
162-621			10	4.0	162-642			10	10.0
162-622	1-1/8	1-3/4	18	1.9	162-650	1-7/8	2-7/8	14	8.3
162-623			14	3.1	162-653	2	3	14	8.6
162-624			10	5.6	162-654			10	15.0
162-625	1-1/4	1-7/8	18	2.0	162-657	2-1/8	3-1/8	10	16.3

18 Ga.=.050"; 14 Ga.=.083"; 10 Ga.=.134"

ASSORTMENT

No. 020-875

This assortment is made up of 174 Machinery Bushings selected by popularity. Twenty eight sizes for complete coverage. The 020-875 Assortment includes a 3-colour display board and 13 screw hooks. Ideal for Implement and Machinery dealers.

020-875



BRASS WASHERS RONDELLES EN LAITON

162
Series

Papco® Brass Washers are free from burrs and have bright, smooth, flat surfaces. Small or large patterns available from No. 6 to 3/8".



ORDER BY STOCK NUMBER

Stock No.	Score or Bolt Size	I.D.	O.D.	Thickness	Standard Package	Stock No.	Score or Bolt Size	I.D.	O.D.	Thickness	Standard Package
162-802	No. 2	.092	7/32	.018	100	162-815	1/4	.260	11/16	.051	100
162-803	No. 3	.105	1/4	.020	100	162-816	5/16	.337	3/4	.064	100
162-804	No. 4	.119	9/32	.025	100	162-817	5/16	.337	7/8	.064	100
162-805	No. 5	.133	9/32	.025	100	162-818	3/8	.391	7/8	.064	100
162-806	No. 6	.147	5/16	.028	100	162-819	3/8	.391	1	.081	100
162-807	No. 6	.147	3/8	.032	100	162-820	7/16	1/2	1-1/8	.081	50
162-808	No. 8	.172	3/8	.032	100	162-822	1/2	9/16	1-1/4	.091	50
162-809	No. 8	.172	7/16	.036	100	162-823	9/16	5/8	1-1/2	.091	25
162-810	No. 10	.200	7/16	.036	100	162-824	5/8	11/16	1-1/2	.102	25
162-811	No. 10	.200	1/2	.040	100	162-826	3/4	13/16	1-7/8	.114	20
162-812	No. 12	.227	1/2	.040	100	162-828	7/8	15/16	2-1/4	.128	20
162-813	No. 12	.227	9/16	.040	100	162-830	1	1-1/16	2-1/2	.144	20
162-814	1/4	.260	9/16	.040	100						

Small or large patterns available from No. 6 to 3/8.

GARAGE ASSORTMENT

No. 020-056

Contains 100 Brass Washers in popular sizes from No. 10 to 1/2". Packed in a clear plastic box with hinged lid.

020-056



COPPER WASHERS RONDELLES DE CUIVRE

162
Series

Papco® Soft Copper Washers are used as gaskets and have bright, smooth, flat surfaces.



ORDER BY STOCK NUMBER

Stock No.	Screw or Bolt Size	I.D.	O.D.	Thickness	Standard Package	Stock No.	Screw or Bolt Size	I.D.	O.D.	Thickness	Standard Package
162-860	No. 10	7/32	1/2	1/16	100	162-868	3/8	13/32	13/16	1/16	100
162-864	1/4	9/32	5/8	1/16	100	162-870	7/16	15/32	59/64	1/16	50
162-866	5/16	11/32	11/16	1/16	100	162-872	1/2	17/32	1-1/16	3/32	50

For Copper Drain Plug Gaskets see page 169

GARAGE ASSORTMENT

No. 020-083

Contains 100 Copper Washers in six sizes from No. 10 to 1/2". Packed in a transparent plastic box with hinged lid.

020-083



SPACER WASHERS RONDELLES D'ESPACEMENT



162
Series

Papco® Steel Spacer Washers are made from Cold Rolled Steel. All Spacer Washers are 1/32" thick.

ORDER BY STOCK NUMBER

Stock No.	Hole Size	O.D.	Std. Pkg.	Stock No.	Hole Size	O.D.	Std. Pkg.	Stock No.	Hole Size	O.D.	Std. Pkg.
162-910	3/16	1/2	100	162-925	11/16	1-1/16	100	162-936	1-3/8	2	50
162-914	1/4	9/16	100	162-926	3/4	1-1/8	100	162-938	1-1/2	2-1/4	50
162-916	5/16	5/8	100	162-927	13/16	1-1/4	100	162-940	1-5/8	2-3/8	25
162-918	3/8	3/4	100	162-928	7/8	1-3/8	100	162-942	1-3/4	2-1/2	25
162-920	7/16	13/16	100	162-930	1"	1-1/2	50	162-944	2"	2-3/4	25
162-922	1/2	7/8	100	162-932	1-1/8	1-5/8	50	162-946	2-1/8	3"	25
162-923	9/16	1"	100	162-934	1-1/4	1-7/8	50	162-948	2-1/4	3-1/4	25
162-924	5/8	1"	100								

GARAGE ASSORTMENT

No. 020-058

Contains 125 Steel Spacer Washers all 1/32" thick in sizes from 1/4" to 1-1/2". Packed in a transparent, plastic box.

020-058



TENSION WASHERS RONDELLES À TENSION

These heat treated spring steel washers are used to eliminate rattles in rods and connecting levers and to take up side play and lost motion in carburetor linkage, clevis yokes, brake shoe pins and gear shift rods etc.

ORDER BY STOCK NUMBER

Standard Package: 100 Pieces

Stock No.	Shaft Dia.
162-963	3/16
162-964	1/4
162-965	5/16
162-966	3/8
162-967	7/16
162-968	1/2



UTILITY ASSORTMENT

No. 020-351

Contains 210 Tension Washers. 35 each of six sizes in a sturdy, fibreboard container with individual compartments.

020-351



**STANDARD COUNTERSUNK FINISHING WASHERS
RONDELLES DE FINITION FRAISÉES RÉGULIÈRES**

**162
Series**

Papco[®] Countersunk Finishing Washers are made from sheet brass and nickel Plated. Used in body trim work with countersunk head screws and bolts. Standard package 100 Washers.



Standard Type

ORDER BY STOCK NUMBER

Stock No.	Screw Size	Inside Dia.	Outside Dia.
Countersunk Standard Type			
162-971	No. 6	.167	7/16
162-973	No. 8	.193	1/2
162-975	No. 10	.228	19/32
162-977	No. 12	.291	11/16
162-979	1/4	.318	25/32

GARAGE ASSORTMENT

No. 020-030

Contains 200 Nickel Plated Finishing Washers used with Countersunk Head Screws. Sizes from No. 6 to 1/4". Packed in a sturdy, clear plastic container.



SCREWS

VIS



ROOFING/SIDING SCREWS

STOVE BOLTS

MACHINE SCREWS

HEX MACHINE SCREWS NUTS

WOOD SCREWS

TAPPING SCREWS

THREAD CUTTING SCREWS

SPEE-DRILL® SCREWS

TRIM SCREWS

**TRUCK AND TRAILER
FASTENERS**

FLOORBOARD SCREWS

BULL-DOG DRIVERS

CONCRETE SCREWS

**CONDRIVE® INSTALLATION
TOOL**

SLEEVE ANCHORS

WEDGE ANCHORS

ROOFING/SIDING SCREWS VIS DE TOITURE

126
Series

'Self Sealing' Indented Hex Washer Head with Weather Sealing Washer

Specially designed screws for attaching metal siding or roofing. Features a neoprene weather sealing washer under the head of screws. High-carbon, zinc plated steel. Also available with painted heads in white, bone, brown and red. Price on application.

ORDER BY STOCK NUMBER

Standard Package: 100 Screws

Stock No.	Size	Hex Head Across Flats	Stock No.	Size	Hex Head Across Flats
126-950	10 x 1	1/4	126-963	14 x 1-1/4	3/8
126-952	10 x 1-1/2	1/4	126-964	14 x 1-1/2	3/8
126-954	10 x 2	1/4	126-966	14 x 2	3/8
126-962	14 x 1	3/8	-	-	-



STOVE BOLTS BOULONS DE POELE

195
Flat

196
Round

- With Hex Nuts
- Round Socket/Slot Combination Drive
- Flat Socket Drive

ORDER BY STOCK NUMBER

Standard Package: 100 Bolts and Nuts

Flat Head			Round Head		
Stock No.	Size	Stock No.	Stock No.	Size	Stock No.
Flat	Round	Size	Flat	Round	Size
195-087	196-087	1/8 x 1/2	195-195	196-195	3/16 x 1-1/4
195-089	196-089	1/8 x 3/4	195-197	196-197	3/16 x 1-1/2
195-091	196-091	1/8 x 1	195-199	196-199	3/16 x 1-3/4
195-093	196-093	1/8 x 1-1/4	195-200	196-200	3/16 x 2
195-095	196-095	1/8 x 1-1/2	195-202	196-202	3/16 x 2-1/2
195-189	196-189	3/16 x 1/2	195-204	196-204	3/16 x 3
195-191	196-191	3/16 x 3/4	195-305	196-305	1/4 x 1/2
195-193	196-193	3/16 x 1	195-306	196-306	1/4 x 5/8
			195-307	196-307	1/4 x 3/4
			195-309	196-309	1/4 x 1
			195-311	196-311	1/4 x 1-1/4
			195-313	196-313	1/4 x 1-1/2
			195-315	196-315	1/4 x 1-3/4
			195-316	196-316	1/4 x 2
			195-317	196-317	1/4 x 2-1/4
			195-318	196-318	1/4 x 2-1/2
			195-320	196-320	1/4 x 3
			195-444	196-444	5/16 x 1
			195-448	196-448	5/16 x 1-1/2
			195-451	196-451	5/16 x 2
			195-453	196-453	5/16 x 2-1/2
			195-455	196-455	5/16 x 3
			195-493	196-493	3/8 x 1-1/2
			195-496	196-496	3/8 x 2
			195-498	196-498	3/8 x 2-1/2
			195-500	196-500	3/8 x 3

STOVE BOLTS ASSORTMENTS ASSORTIMENTS DE BOULONS DE POELE

GARAGE ASSORTMENT ROUND HEAD

No. 020-044

- Contains 68 Stove Bolts from 3/16" x 1/2" to 1/4" x 2".
- Packed in rigid, transparent, plastic container.

FLAT HEAD GARAGE ASSORTMENT

No. 020-045

- Contains 68 Stove Bolts from 3/16" x 1/2" to 1/4" x 2".
- Packed in rigid, transparent, plastic container.

STOVE BOLT UTILITY ASSORTMENT

No. 020-324

Contains 200 Round Head Stove Bolts, from 3/16" x 1/2" to 1/4" x 2".



020-044



020-324

Stove Bolt and Machine Screw Equivalent Sizes

Stove Bolt Diameter	1/8	5/32	3/16	1/4	5/16	3/8
Machine Screw Size	6-32	8-32	10-24	1/4-20	5/16-18	3/8-16

MACHINE SCREWS VIS DE MÉCANIQUE



1741
Round

176
Flat

Papco® Machine Screws are used on window moulding, door handles, instrument panels, lamp rims and many other applications.

ORDER BY STOCK NUMBER

Standard Package: 100 Pieces

Socket/Slot Combination Drive						Loxxon® Square Socket Drive					
											
Stock No.		Screw Dia.	Threads Per Inch	Screw Length	Decimal Equiv. of Dia.	Stock No.		Screw Dia.	Threads Per Inch	Screw Length	Decimal Equiv. of Dia.
Round	Flat					Round	Flat				
1741-039		4	40	1/4	.112	1741-189	176-189	10	24	1/2	.190
1741-043				1/2		3/4					
1741-083		6	32	1/4	.138	1741-193	176-193	10	32	1	.190
1741-085	176-085			3/8		1-1/4					
1741-087	176-087			1/2		1741-195	176-195			1-1/4	
1741-089	176-089			3/4		1741-197	176-197			1-1/2	
1741-091	176-091			1		1741-213				1/4	
1741-093	176-093			1-1/4		1741-215	176-215			3/8	
1741-095	176-095			1-1/2		1741-217	176-217			1/2	
1741-133		8	32	1/4	.164	1741-219	176-219			3/4	.190
1741-135	176-135			3/8		1					
1741-137	176-137			1/2		1741-221	176-221			1-1/4	
1741-139	176-139			3/4		1741-223	176-223			1-1/2	
1741-141	176-141			1		1741-225	176-225			1	
1741-143	176-143			1-1/4		1741-305	176-305	1/4	20	1/2	.250
1741-145	176-145			1-1/2		1741-307	176-307			3/4	
1741-185		10	24	1/4	.190	1741-309	176-309			1	.190
1741-187	176-187			3/8		1-1/4					
						1741-311	176-311			1-1/4	
						1741-313	176-313			1-1/2	
						1741-316	176-316			2	

HEX MACHINE SCREWS NUTS ÉCROUS DE VIS DE MÉCANIQUE

184
Series



ORDER BY STOCK NUMBER

Standard Package: 100 Pieces

Stock No.	Size	Threads Per Inch	Dimensions		Stock No.	Size	Threads Per Inch	Dimensions	
			Across Flats	Thickness				Across Flats	Thickness
184-004	4	40	1/4	3/32	184-011	10	32	3/8	1/8
184-005	5	40	5/16	7/64	184-012	12	24	7/16	5/32
184-006	6	32	5/16	7/64	184-014	1/4	20	7/16	3/16
184-008	8	32	11/32	1/8	184-015	1/4	28	7/16	3/16
184-010	10	24	3/8	1/8					

ROUND HEAD GARAGE ASSORTMENT

Socket/Slot Combination Drive

No. 020-010

Contains 130 Round Combination Socket/Slot Head plated Machine Screws in various sizes and 45 Hexagon plated Nuts. Packed in rigid, transparent, plastic containers.

020-010



MACHINE SCREWS ASSORTMENTS ASSORTIMENTS VIS DE MÉCANIQUE

FLAT HEAD GARAGE ASSORTMENT

No. 020-011

Contains 130 Flat Head plated Machine Screws in various sizes and 45 Hexagon plated Nuts. Packed in rigid, transparent, plastic containers.

020-011



ROUND HEAD SQUARE DRIVE UTILITY ASSORTMENT

No. 020-331

Contains 320 Round Head Machine Screws and Nuts. 16 sizes from 4-40 x 1/2" to 10-32 x 1-1/2".

020-331



FLAT HEAD SQUARE DRIVE UTILITY ASSORTMENT

No. 020-333

Contains 350 Flat Head Machine Screws and Nuts.

Screws – 6-32 x 3/8", 8-32 to 1/4" x 1-1/2".

Nuts – 6-32, 8-32, 10-24, 1/4".

SQUARE DRIVE MACHINE SCREW AND NUT MASTER ASSORTMENT

No. 020-624

A practical assortment that gives complete coverage of all popular sizes of Machine Screws and Nuts.

Size: 9-3/4" W x 13-3/4" L x 2" D.

- Contains 1120 pieces - 32 sizes, Round and Flat Head and Hexagon Nuts.
- Metal box with moulded plastic compartments.
- Safety snap carrying handle.
- Actual size illustrations and retail price codes of every item shown on grease-resistant lid label.
- Refills available in standard packages of 100.

020-624



MACHINE SCREW AND NUT 'SUPER-SERVICE' ASSORTMENT

No. 020-806

Perfect for Dealers, Jobbers and large users. This popular assortment has a wide range of carefully selected Machine Screws and Nuts in balanced quantities.

Size: 12" W x 18" L x 3" D.

- Contains 2750 pieces - 32 sizes, Round Combination and Flat Head Square Drive Machine Screws with Nuts.
- Large size, rigid metal box with high-strength plastic compartments.
- Convenient, safety snap carrying handle.
- Actual size illustrations and retail codes of every item shown on grease-resistant lid label.
- Refills available in standard packages of 100.

020-806



PHILLIPS MACHINE SCREWS VIS DE MÉCANIQUE, TÊTE PHILLIPS

173
Round

175
Oval

ORDER BY STOCK NUMBER

Standard Package: 100 Pieces

Phillips Type (cross recessed) screws are used on all trim applications.



Round Head



Oval Head

Stock No.		Screw Diameter	Threads Per Inch	Screw Length	Decimal Equivalent
Round	Oval				
173-085		6	32	3/8	.138
173-135		8	32	3/8	
173-137	175-137			1/2	.164
173-139	175-139			3/4	
173-141	175-141			1	
173-189		10	24	1/2	
173-191	175-191			3/4	.190
173-193				1	
173-215		10	32	3/8	
173-217	175-217			1/2	.190
173-219				3/4	
173-305		1/4	20	1/2	
173-307	175-307			3/4	.250
173-309				1	

ROUND HEAD GARAGE ASSORTMENT

No. 020-012

- Contains 100 plated Phillips Head Machine Screws and 50 Hexagon plated Nuts in popular sizes.
- Packed in a rigid, transparent plastic container.
- Order by stock number.



020-012

MASTER ASSORTMENT

No. 020-623

- Contains 786 pieces – 20 sizes. Round and Oval Head and Hexagon Nuts.
- Rigid, metal box with handy moulded compartments.
- Carrying handle with safety snap lock.
- Illustrated lid label shows retail codes.
- Refills available in standard packages.



020-623

**WOOD SCREWS
VIS À BOIS**

197 Flat Steel	198 Round Steel	203 Flat Brass	204 Round Brass
-----------------------------	------------------------------	-----------------------------	------------------------------

ORDER BY STOCK NUMBER

Standard Package: 100 Screws

Loxxon[®] Square Socket Drive

Papco[®] Wood Screws are available in over 300 stock sizes in Brass and Steel and in various Head Styles and Drives. All Papco[®] Steel Wood Screws listed here are Bright Plated.



Flat Socket Steel add prefix 197 **Round Socket Steel add prefix 198**
Example of Stock No. 197-139 is 8 x 3/4 Flat Socket Steel Wood Screws plated.

Flat Socket Brass add prefix 203 **Round Socket Brass add prefix 204**
Example of Stock No. 203-139 is 8 x 3/4 Flat Socket Brass Wood Screws.

Diameter	No. 4	No. 5	No. 6	No. 7	No. 8	No. 9	No. 10	No. 12	No. 14
Decimal Equiv. of Diameter	.112	.125	.138	.155	.165	.177	.191	.218	.251
Drill Pilot Hole*	3/64	1/16	1/16	1/16	5/64	5/64	3/32	7/64	7/64
Drill Shank Hole*	7/64	1/8	9/64	5/32	11/64	3/16	3/16	7/32	1/4
Length									
1/2	-043	-063	-087	-111	-137				Steel Socket Only
5/8	-044	-064	-088	-112	-138				
3/4	-045	-065	-089	-113	-139		-191		
1	-047	-067	-091	-115	-141	-167	-193	-250	-280
1-1/4			-093	-117	-143	-169	-195	-252	-282
1-1/2			-095	-119	-145	-171	-197	-254	-284
1-3/4							-199		-286
2					-148		-200	-257	-287
2-1/2					-150		-202	-259	-289
3							-204	-261	-291

* Sizes of holes recommended for average application. Slightly larger or smaller holes may be required for hard or soft woods.
 Note: Additional sizes of Wood Screws in Steel, Brass, Stainless Steel and Silicon Bronze are available - see current Non-Ferrous catalogue.

STEEL GARAGE ASSORTMENT

No. 020-201

Contains 160 pieces - 8 sizes of Flat Socket Head Steel Wood Screws Plated. Packed in a transparent plastic box.



STEEL UTILITY ASSORTMENT

No. 020-354

Contains 460 pieces Flat and Round Socket Steel Wood Screws Plated. Twelve sizes from No. 4 x 1/2 to No. 10 x 1-1/2. Strong display box with moulded plastic compartments. Refills available in standard packages.



BRASS GARAGE ASSORTMENT

No. 020-210

Contains 155 pieces - 8 sizes of Flat and Round Socket Head Brass Wood Screws from No. 6 x 1/2 to No. 8 x 1-1/2. Packed in a transparent lidded plastic box.



020-210

BRASS UTILITY ASSORTMENT

No. 020-356

Contains 380 pieces Flat and Round Socket Brass Wood Screws. Twelve sizes from No. 4 x 1/2 to No. 10 x 1-1/2. Packed in a sturdy fibreboard container.



020-356

STEEL MASTER ASSORTMENT

No. 020-600

Contains 850 pieces Flat and Round Socket Steel Wood Screws Plated. Twelve sizes from No. 4 x 1/2 to No. 10 x 1-1/2. Packed in a metal box with molded plastic compartments.



020-600

BRASS MASTER ASSORTMENT

No. 020-601

Contains 735 pieces Flat and Round Socket Brass Wood Screws. Twelve sizes from No. 4 x 1/2 to No. 10 x 1-1/2. Packed in a metal box with molded plastic compartments.



020-601

TAPPING SCREWS VIS TARAUDEUSES

205
Pan
Head



206
Oval
Head



- Slot Head, Sheet Metal Screws, Self-tapping, Hardened.

Papco® Sheet Metal Screws are used in the assembly of sheet metal parts and for making fastenings to sheet metal. They are used in body work for attaching window molding, trim, panels, metal drip molding and many other applications.

ORDER BY STOCK NUMBER

Standard Package: 100 Pieces

Pan Head Stock No.	Oval Head Stock No.	Screw Dia.	Screw Length	Decimal Equiv. of Dia.	Drill Hole	Pan Head Stock No.	Oval Head Stock No.	Screw Dia.	Screw Length	Decimal Equiv. of Dia.	Drill Hole
205-039		4	1/4	.112	5/64	205-187		10	3/8	.191	9/64
205-041			3/8			205-189	206-189		1/2		
205-043	206-043		1/2			205-190	206-190		5/8		
205-044	206-044		5/8			205-191	206-191		3/4		
205-083		6	1/4	.138	3/32	205-193	206-193		1		
205-085	206-085		3/8			205-195	206-195		1-1/4		
205-087	206-087		1/2			205-197		12	1-1/2	.218	5/32
205-088	206-088		5/8			205-247			5/8		
205-089	206-089		3/4			205-248	206-248		3/4		
205-091	206-091		1			205-250	206-250		1		
205-093	206-093		1-1/4			205-252			1-1/4		
205-135		8	3/8	.165	1/8	205-254	206-254		1-1/2		
205-137	206-137		1/2			205-278	206-278	14	3/4	.251	3/16
205-138	206-138		5/8			205-280	206-280		1		
205-139	206-139		3/4			205-282			1-1/4		
205-141	206-141		1								
205-143	206-143		1-1/4								
205-145			1-1/2								

THREAD CUTTING SCREWS VIS À FILETAGE COUPANT

223
Series



Round



Pan



Hexagon

Type 1 Screws

These hardened screws cut their own Standard Machine Screw Thread in any metal. The off-centre thread cutting slot acts as a tap when the screw is driven. Papco® Thread Cutting Screws are ideal to have on hand when stripped threads need repair.

ORDER BY STOCK NUMBER

Standard Package: 100 Pieces

Stock No.	Size	Head Type	Decimal Dia.	Drill Hole	Stock No.	Size	Head Type	Decimal Dia.	Drill Hole
223-010	4-40 x 3/8	Round	.112	No. 43	223-079	10-32 x 1/2	Round		No. 19
223-016	6-32 x 1/2	Round	.138		223-086	10-32 x 3/4	Round		(.166)
223-022	6-32 x 3/4	Round			223-103	12-24 x 1/2	Round	.216	3/16
223-034	8-32 x 3/8	Round		No. 28 (.140)	223-120	1/4-20 x 1/2	Round	.250	7/32
223-037	8-32 x 1/2	Round	.164		223-131	1/4-20 x 1	Hex		
223-043	8-32 x 3/4	Round			223-143	5/16-18 x 1/2	Hex	.312	9/32
223-058	10-24 x 1/2	Round	.190	No. 21 (.159)	223-152	5/16-18 x 1	Hex		
223-068	10-24 x 1	Pan							

THREAD CUTTING SCREW ASSORTMENT

No. 020-856

- Contains 250 Screws, 16 sizes.
- Needed in every shop and service department.
- Like having a set of Machine Screw Size Taps.
- Cuts all threads from No. 4-40 to 5/16-18.
- Rigid, plastic compartmentalized container.

020-856



TAPPING SCREW ASSORTMENTS ASSORTIMENTS DE VIS TARAUEUSES

HEXAGON HEAD GARAGE ASSORTMENT

No. 020-024

Contains 100 Hexagon Head Tapping Screws in various lengths and diameters from No. 8 x 1/2 to 5/16 x 1.



020-024

PAN SLOT GARAGE ASSORTMENT

No. 020-026

Contains 165 Pan Slot Head Tapping Screws in various lengths and diameters from No. 4 x 1/2 to No. 14 x 1.



020-026

PAN SOCKET GARAGE ASSORTMENT

No. 020-200

Contains 175 Pan Socket Head Tapping Screws in various lengths and diameters from No. 6 x 1/2 to No. 10 x 1.



020-200

SLOT UTILITY ASSORTMENT

No. 020-312

Contains 495 pieces – 18 sizes, Pan and Oval Slot Heads. Packed in a sturdy fibreboard container with plastic tray. Actual size illustrations and retail price codes of every item shown on lid label.

Size: 7-1/2 x 12 x 1-1/4



020-312

SOCKET UTILITY ASSORTMENT

No. 020-353

Contains 500 pieces – 16 sizes, Pan Socket Head. Packed in a sturdy fibreboard container with molded plastic trays. Refills available in standard packages.



020-353

TAPPING SCREWS ASSORTMENTS ASSORTIMENTS DE VIS TARAUEUSES

Papco® Sheet Metal Screws designed especially for Dealers, Service Stations and Garages. Use these attractive, permanent merchandisers to increase your sales – and profits – on this fast moving line!

SLOT TAPPING SCREW MASTER ASSORTMENT

No. 020-612

Contains 937 pieces – 18 sizes of Pan, Oval and Hex Slot Tapping Screws. Metal box with molded plastic compartments and hinged lid. Actual size illustrations on lid label. Refills available in standard packages.

Size: 9-3/4" W x 13-3/4" L x 2" D.



020-612

HEX MASTER ASSORTMENT

No. 020-615

Excellent assortment of Hexagon Steel Metal Screws and Fender Washers for the well-equipped Body Shop. Contains 280 Hexagon Head Screws, 125 Flat Fender Washers, 20 popular sizes.

Size: 9-3/4" W x 13-3/4" L x 2" D.



020-615

PAN SOCKET TAPPING MASTER ASSORTMENT

No. 020-660

Contains 1000 pieces – 25 sizes of Pan Socket Head Tapping Screws. Packed in a metal box with high-strength plastic compartments. Actual size illustrations and retail price codes of every item shown on grease-resistant lid label.



020-660

PAN AND OVAL SLOT TAPPING SCREW 'SUPER-SERVICE' ASSORTMENT

No. 020-807

Contains 1450 Pan and Oval Slot Head Tapping Screws – 32 items. Large size, rigid metal box with high-strength plastic compartments. For more details see page 10 .

Size: 12" W x 18" L x 3" D.



020-807

SOCKET TAPPING SCREWS VIS TARAUDEUSES CREUSE

208
Pan
Head



209
Flat
Head



210
Truss
Head



- Sheet Metal Screws, Self-Tapping, Hardened.

Loxon® Square Socket Drive

Specify Papco® Pan, Flat or Truss Socket Head Tapping Screws where a positive driver engagement, or where high-speed assembly of sheet metal parts, is required. They are used in body work, moldings, trim, sheet metal work and many other applications.

ORDER BY STOCK NUMBER

Standard Package: 100 Pieces

Pan Head Stock No.	Flat Head Stock No.	Truss Head Stock No.	Screw Dia.	Screw Length	Decimal Equiv. of Dia.	Drill Hole	Pan Head Stock No.	Flat Head Stock No.	Truss Head Stock No.	Screw Dia.	Screw Length	Decimal Equiv. of Dia.	Drill Hole
208-039				1/4			208-187				3/8		
208-041	209-041			3/8			208-189	209-189	210-189		1/2		
208-043	209-043		4	1/2	.112	5/64	208-190	209-190	210-190		5/8		
208-045	209-045			3/4			208-191	209-191	210-191	10	3/4	.191	9/64
208-047	209-047			1			208-193	209-193	210-193		1		
208-083				1/4			208-195	209-195	210-195		1-1/4		
208-085	209-085	210-085		3/8			208-197	209-197			1-1/2		
208-087	209-087	210-087		1/2			208-200	209-200			2		
208-088	209-088	210-088	6	5/8	.138	3/32	208-246	209-246			1/2		
208-089	209-089	210-089		3/4			208-248	209-248			3/4		
208-091	209-091	210-091		1			208-250	209-250		12	1	.218	5/32
208-093	209-093			1-1/4			208-252	209-252			1-1/4		
208-095	209-095			1-1/2			208-254	209-254			1-1/2		
208-135		210-135		3/8			208-257				2		
208-137	209-137	210-137		1/2			208-277	209-277			5/8		
208-138	209-138	210-138		5/8			208-278	209-278			3/4		
208-139	209-139	210-139	8	3/4	.165	1/8	208-280	209-280		14	1	.251	3/16
208-141	209-141	210-141		1			208-282	209-282			1-1/4		
208-143	209-143	210-143		1-1/4			208-284	209-284			1-1/2		
208-145	209-145	210-145		1-1/2			208-287	209-287			2		
208-148	209-148			2									

HEX HEAD TAPPING SCREWS VIS TARAUDEUSES TÊTE HEX

213
Hex Head



- Self-Tapping and Hardened.

Oversize Hexagon Washer Heads to fit Automotive Cap Screw Wrenches.

ORDER BY STOCK NUMBER

Standard Package: 100 Pieces

Stock No.	Screw Dia.	Screw Length	Decimal Equiv. of Dia.	Across Flats	Drill Hole	Stock No.	Screw Dia.	Screw Length	Decimal Equiv. of Dia.	Across Flats	Drill Hole
213-085	6	3/8	.138	1/4	3/32	213-250	12	1	.218	5/16	5/32
213-137		1/2				213-276		1/2			
213-139		3/4				213-277		5/8			
213-141	8	1	.165	1/4	1/8	213-278	14	3/4	.251	7/16	3/16
213-143		1-1/4				213-280		1			
213-145		1-1/2				213-282		1-1/4			
213-187		3/8				213-284		1-1/2			
213-189		1/2				213-442		3/4			
213-190	10	5/8	.191	5/16	9/64	213-444	5/16	1	.312	1/2	9/32
213-191		3/4				213-446		1-1/4			
213-193		1				213-448		1-1/2			
213-246		1/2				213-489		1			
213-248	12	3/4	.218	5/16	5/32	213-493	3/8	1-1/2	.375	9/16	11/32

'SUPER-SERVICE' ASSORTMENT

No. 020-808

Contains 650 Hexagon Head Tapping Screws and Fender Washers. Large size, rigid metal box with high-strength plastic compartments. For more details see page 10. Size: 12" W x 18" L x 3" D.



020-808

**SPEE-DRILL[®] SCREWS
VIS SPEE-DRILL[®]**

**222
Series**



- Thread Forming
- Self Drilling

Papco[®] Spee-Drill[®] Screws are driven with a standard electric drill. The special hardened conical point bores through sheet metal and the serrated washer face prevents thread stripping.

ORDER BY STOCK NUMBER

Standard Package: 100 Pieces, * Standard Package: 1,000 Pieces

Stock No.	Stock No.	Diameter x Length	Stock No.	Stock No.	Diameter x Length
100's	1,000's*	Size	100's	1,000's*	Size
222-085	222-585	6 x 3/8	222-189	222-689	10 x 1/2
222-111	222-611	7 x 1/2	222-191	222-691	10 x 3/4
222-137	222-637	8 x 1/2			

Note: All Papco[®] Spee-Drill[®] Screws are Hex, Slotted, Washer Head with 1/4 across flats head size.

SPEE-DRILL SCREW KIT

No. 020-617

Contains 1,000 Papco[®] Spee-Drill[®] Screws, 5 sizes and includes the Papco[®] Magnetic Chuck No. 222-360.

- All-metal box with hinged lid.
- Safety snap lock and carrying handle.
- Grease-resistant lid label with retail codes.



020-617

**6 IN 1 MAGNETIC SCREWDRIVER SET
JEU DE TOURNEVIS AIMANTE**

No. 222-996

Uses 1/4" Hex Base Bits

Magnetized shaft holds bit and screw for easy use. Driver comes complete with six high quality bits - 1/4" Slotted, No. 1 and No. 2 Phillips, No. 1 and No. 2 Loxxon[®] Square Socket and a T-15 6-Lobe. When not in use bits are stored in an impact-resistant, plastic handle. Shaft end can be used as a nut driver. Screw driver with 6 bits skin-packed on a handy point-of-purchase display card.



222-996

**6-LOBE MAGNETIC SCREWDRIVER SET
JEU DE TOURNEVIS AIMANTE**

No. 231-975

Same Magnetic Screwdriver as above. Driver comes complete with four high quality 6-Lobe bits - T-10, T-15, T-20 and T-25. Driver and bits skin-packed on colourful self-selling display card.



231-975

**MAGNETIC NUT SETTER
TOURNE-ÉCROUS MAGNÉTIQUE**

No. 222-570

Individually Packaged. Fits all five sizes of Papco[®] Spee-Drill[®] Screws. Fits standard electric drill. Has hexagon shank for positive drive. Permanent high-strength Alnico magnet. Made of heat treated tool steel for long life.



222-570

**TRIM SCREWS
VIS DE FINITION**

**229
Series**

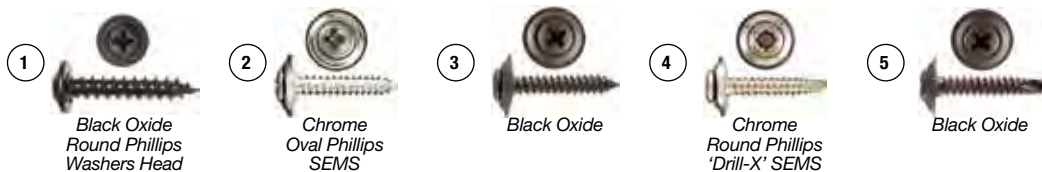

ORDER BY STOCK NUMBER

Standard Package: Type 1 = 100 pieces, Types 2 to 5 = 50 pieces

Bright Chromium or Black Oxide Plated

Stock No.	Diameter x Length	Head Type	Stock No.	Diameter x Length	Head Type	Stock No.	Diameter x Length	Head Type
229-401	8 x 1/2	1	229-806	6 x 3/4	2 O. R.	229-849	8 x 5/8	3 O. S.
229-402	8 x 5/8	1	229-811	8 x 3/4	2 O. S.	229-851	8 x 3/4	3 O. S.
229-403	8 x 3/4	1	229-815	8 x 1	2 O. S.	229-855	8 x 1	3 O. S.
229-405	8 x 1	1	229-819	8 x 1-1/4	2 O. S.	229-883	10 x 3/4	3 O. S.
229-407	8 x 1-1/4	1	229-833	10 x 3/4	2 O. S.	229-887	10 x 1	3 O. S.
229-414	10 x 3/4	1	229-837	10 x 1	2 O. S.	229-985	8 x 3/4	4 O. S.
229-416	10 x 1	1				229-986	8 x 1	4 O. S.
						229-987	8 x 3/4	5 O. S.
						229-988	8 x 1	5 O. S.

O. S. - Oval Small Head

O. R. - Oval Regular Head

For Papco[®] Trim Screws Master Assortments No. 020-661 see pages 8 and 50.

**BLACK TRIM SCREWS
MASTER ASSORTMENT**

No. 020-662

Contains 350 screws. For more details see page 8.

020-662



**PHILLIPS TAPPING SCREWS
VIS TARAUDEUSES PHILLIPS**



**229
Series**

- Recessed Head, Self-tapping.
- Bright Plated, Hardened.



Oval Regular



Pan Head

ORDER BY STOCK NUMBER

Standard Package: 100 Pieces

Stock No.	Diameter x Length	Head Type	Stock No.	Diameter x Length	Head Type	Stock No.	Diameter x Length	Head Type
229-010	6 x 1/2	O. R.	229-041	10 x 5/8	O. R.	229-124	8 x 1	P. H.
229-012	6 x 3/4	O. R.	229-044	10 x 1	O. R.	229-140	10 x 1/2	P. H.
229-014	6 x 1	O. R.	229-108	6 x 3/8	P. H.	229-142	10 x 3/4	P. H.
229-016	6 x 1-1/4	O. R.	229-110	6 x 1/2	P. H.	229-144	10 x 1	P. H.
229-022	8 x 3/4	O. R.	229-119	8 x 3/8	P. H.	229-160	12 x 1/2	P. H.
229-024	8 x 1	O. R.	229-120	8 x 1/2	P. H.	229-164	12 x 1	P. H.
229-026	8 x 1-1/4	O. R.	229-122	8 x 3/4	P. H.			

O. R. - Oval Regular

P. H. - Pan Head

**TRIM SCREWS
VIS DE FINITION**



- Zinc or Black Oxide plated.

These Oval and Pan Phillips Head Screws are used in all interior and exterior trim applications on cars and trucks.



Oval Head



Pan Head

ORDER BY STOCK NUMBER

Standard Package: 100 Pieces

Stock No.	Diameter x Length	Head Type	Stock No.	Diameter x Length	Head Type	Stock No.	Diameter x Length	Head Type
229-219	8 x 3/8 Zinc	O. S.	229-242	10 x 3/4 Zinc	O. S.	229-923	8 x 1-1/2 Black	O. S.
229-220	8 x 1/2 Zinc	O. S.	229-244	10 x 1 Zinc	O. S.	229-933	10 x 3/4 Black	O. S.
229-222	8 x 3/4 Zinc	O. S.	229-248	10 x 1-1/2 Zinc	O. S.	229-937	10 x 1 Black	O. S.
229-224	8 x 1 Zinc	O. S.	229-250	10 x 2 Zinc	O. S.	229-945	10 x 1-1/2 Black	O. S.
229-225	8 x 1-1/8 Zinc	O. S.	229-252	10 x 2-1/2 Zinc	O. S.	229-960	6 x 1/2 Black	P. H.
229-226	8 x 1-1/4 Zinc	O. S.	229-911	8 x 3/4 Black	O. S.	229-962	8 x 1/2 Black	P. H.
229-227	8 x 1-3/8 Zinc	O. S.	229-912	8 x 3/4 Black	O. R.	229-968	8 x 3/4 Black	P. H.
229-228	8 x 1-1/2 Zinc	O. S.	229-915	8 x 1 Black	O. S.	229-972	8 x 1 Black	P. H.
229-229	8 x 1-3/4 Zinc	O. S.	229-916	8 x 1 Black	O. R.	229-980	10 x 3/4 Black	P. H.
229-240	10 x 1/2 Zinc	O. S.	229-919	8 x 1-1/4 Black	O. S.	229-982	10 x 1 Black	P. H.
229-241	10 x 5/8 Zinc	O. S.						

O.S. - Oval Small Head

O.R. - Oval Regular Head

P. H. - Pan Head

**TRIM SCREW ASSORTMENTS
ASSORTIMENTS DE VIS DE FINITION**

GARGAGE ASSORTMENT

No. 020-023

- Contains 100 Phillips Head Self-Tapping Sheet Metal Screws in nine popular sizes - in Oval Regular and Oval Small types.
- Packed in a rigid, clear plastic box with hinged lid.



020-023

No. 020-027

- Contains 100 Metric Zinc plated Trim Screws in Pan Oval and Round Washer heads.
- Six sizes in a clear plastic box.



020-027

MASTER ASSORTMENT

No. 020-613

- A well-balanced assortment of Tapping Screws for Trim, Body and Fender work.
- Contains 530 Screws. 25 sizes Phillips Head - Self-Tapping Sheet Metal Screws.
- Safety snap carrying handle.
- Metal box with handy molded compartments.
- Actual size illustrated lid label with retail codes.
- Refills available in standard packages of 100.
- Size: 9-3/4" W x 13-3/4" L x 2" D.



020-613

'SUPER-SERVICE' ASSORTMENT

No. 020-809

- Contains 1225 Phillips Trim Tapping Screws - 30 items
- Large size, rigid metal box with high-strength plastic compartments.
- Size: 12" W x 18" L x 3" D.
- For more details see page 10.



020-809

METRIC TRIM SCREWS VIS DE FINITION MÉTRIQUE

230
Series



- Pozi-Driv Tapping Screws and Bright Chromium plated*.

ORDER BY STOCK NUMBER

Standard Package: 100 Pieces

Pan Head			Oval Small Head		
Stock No.	Dia. x Length	O. E. M. No.	Stock No.	Dia. x Length	O. E. M. No.
230-203	4.2 x 13 mm	11503482	230-207	4.2 x 20 mm	11502471
230-205	4.2 x 20 mm	11501929			
230-206*	4.2 x 20 mm	11500406			

*18.8 Stainless Steel Bright Chromium plated

Note: 4.2 mm = No. 8 diameter (.164)

METRIC MOULDING TRIM SCREWS VIS DE FINITION MOULURE MÉTRIQUE

230
Series



- Round Large Crowned Washer Head (Pozi-Driv Tapping Screws).
- Bright Chromium Plated.

Used in body work for attaching the chrome moulding in the wheel well and floor stripping of late model cars and trucks.

ORDER BY STOCK NUMBER

Standard Package: 100 Pieces

Stock No.	Dia. x Length	O. E. M. No.	Stock No.	Dia. x Length	O. E. M. No.
230-301	4.2 x 8 mm	11503266	230-304	4.2 x 16 mm	11503635
230-302	4.2 x 12 mm	11501794	230-305	4.2 x 20 mm	-
230-303	4.2 x 12 mm Black	11501896	230-306	4.2 x 20 mm Black	11501884

Note: 4.2 mm = No. 8 diameter (.164)

TRUCK AND TRAILER FASTENERS ATTACHES DE CAMION ET REMORQUE

225
Series

- Plywood Lining Screws

Used to fasten plywood liners to body studs and frames.

ORDER BY STOCK NUMBER

Standard Package: 100 Pieces

Stock No.	Diameter x Length	Stock No.	Diameter x Length
225-182	No. 18 x 2" Special Flush Head - Phillips - Wood Screw Bright plated Steel	225-186	No. 10 x 1-1/4" Special Flush Head - Phillips - Type A Bright plated Steel Hardened Tapping Screws
225-183	No. 10 x 3/4" Special Flush Head - Phillips - Thread Forming - Type 'B' Bright plated Steel Hardened Tapping Screws Drill 3/32" pilot hole.	225-188	No. 14 x 2-1/2" Flat Socket Head - Wood Screw Bright plated Steel
225-184	No. 14 x 3" Flat Head - Phillips - Wood Screw Bright plated Steel	225-196 225-197	Aluminium Panel Rivets 225-196 225-197 Made from heat treated aluminium. 225-196 3/16 x 7/16 Full Brazier Head. 225-197 1/4 x 7/16 Mod. Brazier Head. Used to fasten aluminium panels.

**THREAD CUTTING FLOORBOARD SCREWS
VIS AUTOTARAUEUSES POUR PLANCHER**

**225
Series**



- Flat Head Type 'F'

Used to fasten wood plank, laminated plywood or corrugated aluminium flooring to the supporting steel cross members of trucks and trailers.

ORDER BY STOCK NUMBER

Standard Package: 100 Pieces

Stock No.	Size	Driver	Stock No.	Size	Driver
225-792	1/4-20 x 1-1/2	No. 3 Phillips	225-752	1/4-20 x 1-1/2	No. 3 Square
225-793	1/4-20 x 2	No. 3 Phillips	225-753	1/4-20 x 2	No. 3 Square
225-794	1/4-20 x 2-1/2	No. 3 Phillips	225-754	1/4-20 x 2-1/2	No. 3 Square
225-795	1/4-20 x 3	No. 3 Phillips	225-755	1/4-20 x 3	No. 3 Square

**6-LOBE FLOORBOARD SCREWS
VIS À SIX PANS POUR PLANCHER**

- 6-Lobe Flat Head Tri-Lobular, Phosphate and Oil Finish.



ORDER BY STOCK NUMBER

Standard Package: 50 Pieces

Stock No.	Size	Driver	Stock No.	Size	Driver
225-890	1/4-20 x 1	T-30	225-895	1/4-20 x 3	T-30
225-891	1/4-20 x 1-1/4	T-30	225-896	5/16-18 x 1-3/4	T-40
225-892	1/4-20 x 1-1/2	T-30	225-897	5/16-18 x 2	T-40
225-893	1/4-20 x 2	T-30	225-898	5/16-18 x 2-1/2	T-40
225-894	1/4-20 x 2-1/2	T-30			

**DRILL-X[®] SELF-DRILLING TAPPING SCREWS
VIS TARAUD FORET DRILL-X[®]**

**232
Series**

- Papco[®] Self-Drilling and Tapping Screws are made of high-quality steel and are specially heat treated.
- The drill point has been incorporated into the screw in the familiar twist drill design.
- These screws drill their own hole - form mating threads - fasten securely and can be used in steel, plastics, composite materials, wood plus various laminates.
- Determine total thickness of the material to be drilled then choose No. 2 or No. 3 point to allow complete drilling.
- Available in Pan Phillips, Pan Socket and Hex Head.

ORDER BY STOCK NUMBER

Standard Package: 100 Screws

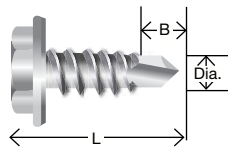

Drill Point length determines maximum Metal thickness drillable.
No. 2 Point up to .110 Thick No. 3 Point up to .250 Thick

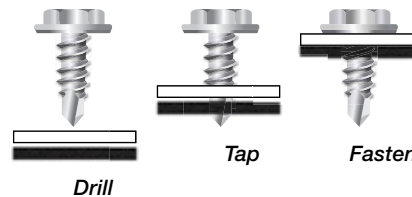

Stock No.	Dia. x (L)	Drill Point	Max-Metal Drillable (B)	Driver	Stock No.	Dia. x (L)	Drill Point	Max-Metal Drillable (B)	Driver
Pan Phillips Head									
232-010	6 x 3/8	No. 2	.090	No. 2	232-016	8 x 1	No. 2	.100	No. 2
232-011	6 x 1/2	No. 2	.090	No. 2	232-020	10 x 1/2	No. 2	.110	No. 2
232-013	8 x 1/2	No. 2	.100	No. 2	232-021	10 x 5/8	No. 3	.175	No. 2
232-014	8 x 5/8	No. 2	.100	No. 2	232-022	10 x 3/4	No. 3	.175	No. 2
232-015	8 x 3/4	No. 2	.100	No. 2	232-024	10 x 1	No. 3	.175	No. 2
Pan Socket Head									
232-030	6 x 3/8	No. 2	.090	No. 2	232-041	8 x 2	No. 2	.100	No. 2
232-031	6 x 1/2	No. 2	.090	No. 2	232-037	10 x 1/2	No. 2	.110	No. 2
232-032	8 x 1/2	No. 2	.100	No. 2	232-038	10 x 5/8	No. 3	.175	No. 2
232-033	8 x 5/8	No. 2	.100	No. 2	232-039	10 x 3/4	No. 3	.175	No. 2
232-034	8 x 3/4	No. 2	.100	No. 2	232-044	10 x 1	No. 2	.175	No. 3
232-035	8 x 1	No. 2	.100	No. 2	232-045	10 x 1-1/4	No. 2	.175	No. 3
232-036	8 x 1-1/2	No. 2	.100	No. 2	232-046	10 x 1-1/2	No. 2	.175	No. 3
232-040	8 x 1-1/4	No. 2	.100	No. 2	232-048	10 x 2	No. 2	.175	No. 3

DRILL-X® SELF-DRILLING TAPPING SCREWS VIS TARAUD FORET DRILL-X®

ORDER BY STOCK NUMBER

Standard Package: 100 Pieces

Stock No.	Dia. x (L)	Drill Point	Max-Metal Drillable (B)	Driver	Stock No.	Dia. x (L)	Drill Point	Max-Metal Drillable (B)	Driver
Hex Washer Head									
232-070	6 x 1/2	No. 2	.100	3/16	232-086	12 x 3/4	No. 3	.210	5/16
232-071	8 x 1/2	No. 2	.100	1/4	232-087	12 x 1	No. 3	.210	5/16
232-072	8 x 5/8	No. 2	.100	1/4	232-101	12 x 1-1/4	No. 3	.210	5/16
232-073	8 x 3/4	No. 2	.100	1/4	232-088	12 x 1-1/2	No. 3	.210	5/16
232-074	8 x 1	No. 2	.100	1/4	232-089	12 x 2	No. 3	.210	5/16
232-075	8 x 1-1/4	No. 2	.100	1/4	232-090	12 x 2-1/2	No. 3	.210	5/16
232-076	8 x 1-1/2	No. 2	.100	1/4	232-091	12 x 3	No. 3	.210	5/16
232-077	8 x 2	No. 2	.100	1/4	232-092	14 x 3/4	No. 3	.250	3/8
232-078	10 x 1/2	No. 2	.175	5/16	232-093	14 x 1	No. 3	.250	3/8
232-079	10 x 5/8	No. 3	.175	5/16	232-094	14 x 1-1/4	No. 3	.250	3/8
232-080	10 x 3/4	No. 3	.175	5/16	232-095	14 x 1-1/2	No. 3	.250	3/8
232-082	10 x 1	No. 3	.175	5/16	232-097	14 x 2	No. 3	.250	3/8
232-083	10 x 1-1/4	No. 3	.175	5/16	232-098	14 x 2-1/2	No. 3	.250	3/8
232-084	10 x 1-1/2	No. 3	.175	5/16	232-099	14 x 3	No. 3	.250	3/8
232-085	10 x 2	No. 3	.210	5/16	232-100	14 x 4	No. 3	.250	3/8

MASTER ASSORTMENT

No. 020-668

- Contains 20 sizes (complete coverage) of Papco® Drill-X® Self-Drilling Tapping Screws in Pan Socket and Hexagon Washer Head.
- Packed in a metal box with high-strength plastic compartments.
- Grease-resistant lid label shows actual size illustrations, measuring chart and retail price codes.



020-668

6-LOBE TRIM SCREWS VIS FINITION À SIX PANS

231
Series



Oval Head



Pan Head

- Metric Stainless Steel Tapping Screws
- Used on automotive trim, headlight and tail-light bezels and many other vehicle and appliance applications.
- The six-lobed drive system improves driver tool life, stops cam-out and increases mechanic's efficiency.
- These stainless steel screws have Bright Chromium or Black Oxide finish to conform to original specifications.

ORDER BY STOCK NUMBER

Standard Package: 25 Pieces

Oval Trim Head					Pan Head				
Stock No.	Size	Finish	Driver	O. E. M. No.	Stock No.	Size	Finish	Driver	O. E. M. No.
231-205	4.2 x 20 mm	Chrome	T-15	11504069	231-251	4.2 x 20 mm	Chrome	T-15	11504647
231-206	4.2 x 20 mm	Black	T-15	11504659	231-252	4.2 x 20 mm	Black	T-15	11504655
231-209	4.2 x 30 mm	Chrome	T-15	11504522	231-257	4.2 x 35 mm	Chrome	T-15	11504663
231-210	4.2 x 30 mm	Black	T-15	11504656	231-264	4.2 x 50 mm	Black	T-15	11504774
231-213	4.2 x 40 mm	Chrome	T-15	11504654					
231-219	4.2 x 55 mm	Chrome	T-15	11504664					

Note: 4.2 mm = No. 8 diameter (.164)

GARAGE ASSORTMENT

No. 020-070

Contains 70 6-Lobe Oval Head Trim Screws - 6 popular sizes in a clear styrene box.

No. 020-071

Contains 70 6-Lobe Pan Head Trim Screws - 4 popular sizes in a clear styrene box.



020-070

**6-LOBE TRIM SCREWS
VIS FINITION À SIX PANS**

UTILITY ASSORTMENT

No. 020-355

This handy assortment contains 140 6-Lobe Trim Screws in both Oval and Pan Heads - 10 popular sizes packed in a sturdy fibreboard container complete with actual size illustrated, grease-resistant lid label.



020-355

MASTER ASSORTMENT

No. 020-669

This assortment contains 240 6-Lobe Trim Screws in both Oval and Pan Heads - 10 popular sizes packed in a sturdy, metal container with handy moulded compartments, an actual size illustrated, grease-resistant lid label - plus a Papco[®] T-15 Bull-Dog 6-Lobe driver.



020-669

**6-LOBE BULL-DOG DRIVERS
TOURNEVIS À SIX PANS 'BULL-DOG'**

**231
Series**

- Specially designed to be used with 6-Lobe screws, these drivers feature a 1-3/16" Dia. heavy-duty, Bull-Dog handle.
- These professional quality tools permit greater torque and offer a more comfortable grip than regular drivers.

ORDER BY STOCK NUMBER

Individually Carded

8-1/2" Overall Length - 4-1/2" Handle Length

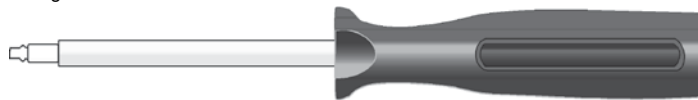

Stock No.	Stock No.	Stock No.	Stock No.	Stock No.	Stock No.	Stock No.	Stock No.
231-980	231-981	231-982	231-983	231-984	231-985	231-986	
T-8	T-10	T-15	T-20	T-25	T-27	T-30	T-40
	6-Lobe Bits with 1/4" shank	231-992	231-993	231-994		231-996	231-998

For 6 in 1 6-Lobe Magnetic Screwdriver see page 114.

TAPCON® CONCRETE SCREWS VIS À BÉTON TAPCON®

**3000
Series**

- Genuine Blue Climaseal® Coating.
- No Plugs.
- Just Drill and Drive.

- Ideal for concrete, brick or hollow block.
- Shear strength: 3/16" Dia. = 145 lbs, 1/4" Dia. = 285 lbs.
- Using the correct Tapcon® Bit, drill hole in masonry to depth of at least 1/4" deeper than installed screw.

NOTE: DO NOT USE BIT TO DRILL STEEL FIXTURES. Position Tapcon® through fixture and drive into pre-drilled hole until seated.

The Condrive® Installation Tool is available for repetitive installations.

ORDER BY STOCK NUMBER

Standard Package: 100 Screws (Includes Tapcon® Drill Bit)

<p><i>Drill</i></p>				<p><i>Drive</i></p>				<p><i>Installed</i></p>				<p><i>Flat Phillips Head</i></p> <p><i>Hex Washer Head</i></p>	
3/16 Diameter				1/4 Diameter									
Phillips Stock No.	Hex Stock No.	Size	Tapcon® Drill Size	Phillips Stock No.	Hex Stock No.	Size	Tapcon® Drill Size	Phillips Stock No.	Hex Stock No.	Size	Tapcon® Drill Size		
3110	3010	3/16 x 1-1/4	5/32 x 3-1/2	3310	3210	1/4 x 1-1/4	3/16 x 3-1/2	3320	3220	1/4 x 1-3/4	3/16 x 3-1/2		
3120	3020	3/16 x 1-3/4	5/32 x 3-1/2	3330	3230	1/4 x 2-1/4	3/16 x 4-1/2	3340	3240	1/4 x 2-3/4	3/16 x 4-1/2		
3130	3030	3/16 x 2-1/4	5/32 x 4-1/2	3350	3250	1/4 x 3-1/4	3/16 x 5-1/2	3370	3270	1/4 x 4	3/16 x 5-1/2		
3140	3040	3/16 x 2-3/4	5/32 x 4-1/2										
3160	3060	3/16 x 3-1/4	5/32 x 5-1/2										

Tapcon®, Climaseal® and Condrive® are registered Trademarks of ITW Buildex

CONDRIVE® INSTALLATION TOOL OUTIL CONDRIVE® D'INSTALLATION

**7000
Series**

- For repetitive installation of Tapcon® Concrete Screws.
- The Condrive® 7000 is a multi- purpose installation tool that is inserted into a 3/8" or 1/2 inch chuck of a standard hammer or electric drill.
- The Condrive® 7000 Tool can be set up to drive either Hex or Phillips drive Tapcon® Screws.

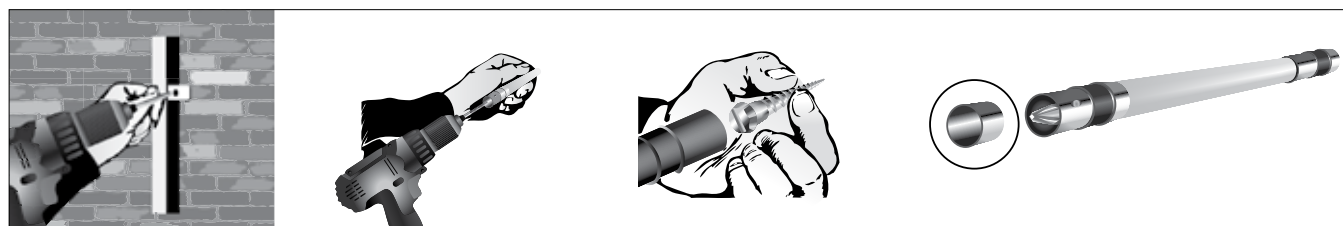

1. Insert drill adapter with drill bit into chuck of electric drill. Drill hole into masonry 1/4" deeper than installed screw.

2. Place Hex or Phillips driver bit into tool. Slide end of tool sleeve over drill bit and snap onto drill adaptor.

3. Insert head of Tapcon® Concrete Screw into Hex or Phillips driver bit. Install screw through fixture into pre-drilled hole until seated.

DYNABOLT[®] SLEEVE ANCHORS
ANCRES À DOUILLE DYNABOLT[®]

3400 Series

- Zinc plated Carbon Steel
- Medium Duty Concrete or Masonry Anchors



- Papco[®] Sleeve Anchors can be used in cement block, thin wall or solid concrete, brick or stone.
- Ideal for anchoring partitions, cabinets, shelves, fire extinguishers, duct work, electrical systems, heating units etc.
- Drill hole same size as diameter of anchor to any depth exceeding minimum embedment.

- Clean hole of dust after drilling. Insert anchor through fixture and tighten nut with wrench 2-3 turns.
- Length is measured from washer to end of anchor.
- For Masonry Drill Bits see page 224.

ORDER BY STOCK NUMBER

Standard Package as listed



Stock No.	Dia. x Length	Min. Embed.	Max. Mat. Thickness	Standard Package	Ultimate Load Capacity*		Use Drill Bit No.
					Load lbs.	Shear lbs.	
3400	1/4 x 1-3/8	1-1/8	1/4	100	1613	1751	997-587
3405	1/4 x 2-1/4	1-1/8	1-1/8	20	1613	1751	997-587
3410	5/16 x 1-1/2	1-1/4	1/4	100	2429	2487	997-588
3415	5/16 x 2-1/2	1-1/4	1-1/4	20	2429	2487	997-588
3420	3/8 x 1-7/8	1-1/2	3/8	50	2597	2872	997-589
3425	3/8 x 3	1-1/2	1-1/2	25	2597	2872	997-589
3430	1/2 x 2-1/4	1-7/8	3/8	10	5385	5582	997-590
3435	1/2 x 3	1-7/8	1-1/8	10	5385	5582	997-590
3440	1/2 x 4	1-7/8	2-1/8	10	5385	5582	997-590

* Ultimate load capacity in 4000 p.s.i. 3/4 inch crushed limestone aggregate concrete for depth of embedment indicated. Safe working loads should not exceed 25% of ultimate load capacity for single installations under static loading.

TRUBOLT[®] WEDGE ANCHORS
ANCRES DE CALAGE TRUBOLT[®]

5000 Series

- Zinc plated Carbon Steel
- Heavy-duty Concrete Anchors

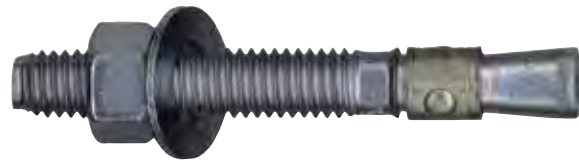

- Papco[®] Heavy-duty Wedge Anchors are ideal for anchoring electrical, heating, ventilating, plumbing and air conditioning systems - storage racks, machinery mounting, highway rails, guards and posts in concrete.
- Each anchor is assembled with a stainless steel expansion clip providing high corrosion resistance and is fully threaded for varying material thicknesses.

- Drill hole same size as diameter of anchor to any depth exceeding concrete embedment.
- Clean hole of dust after drilling. Insert anchor through fixture and tighten nut 3-5 turns.
- Length is measured from washer to end of anchor.

ORDER BY STOCK NUMBER

Standard Package as listed



Stock No.	Dia. x Length	Concrete Embed.	Max. Mat. Thickness	Standard Package	Ultimate Load Capacity*		Use Drill Bit No.
					Load lbs.	Shear lbs.	
5005	1/4 x 2-1/4	1-15/16	7/8	25	2999	1910	997-587
5015	3/8 x 2-1/4	1-1/2	3/8	50	3219	4029	997-589
5020	3/8 x 2-3/4	1-1/2	7/8	40	3219	4029	997-589
5025	3/8 x 3	3	1-1/8	30	5678	4305	997-589
5030	3/8 x 3-3/4	4-1/2	1-7/8	25	5935	4581	997-589
5055	1/2 x 3-3/4	2-1/4	1-1/8	15	5384	6900	997-590
5060	1/2 x 4-1/4	4-1/8	1-1/2	10	7333	7449	997-590
5065	1/2 x 5-1/2	6	2-3/4	10	9003	7998	997-590

* Ultimate load capacity in 4000 p.s.i. stone aggregate for the depth of embedment indicated. Safe working loads should not exceed 25% of ultimate load capacity for single installations under static loading. Dynabolt[®] and Trubolt[®] are registered trademarks of ITW Buildex.

AN INTRODUCTION TO...

POWER TOOL ACCESSORIES

ACCESSOIRES POUR OUTILS ÉLECTRIQUES

...UNE INTRODUCTION.

www.hpaulin.com

For a full listing of Papco® Power Tool Accessories, please refer to our current catalogue or visit our website to download a PDF version.



SOCKET KEY SET

SQUARE RECESS POWER BITS

PHILLIPS RECESS POWER BITS

MAGNETIC NUTSETTER

BIT ACCESSORIES

COLOUR-CODED BIT KITS

COLOUR-CODED POCKET TOOL KITS

SCREWDRIVER BIT SET



**ROTATING CARDED BIT & NUTSETTER MERCHANDISER
PRÉSENTOIRS ROTATIFS, EMBOUTS ET TOURNE-ÉCROUS SUR CARTE**

No. 022-006

- 144 pieces.
- The Pro-Tip[®] two piece square recess power bit has a heat treated S-2 alloy steel tip swagged into a steel body shank.
- The tip is cold formed under rigid dimensional control to ensure a “Cling Fit” with the screw recess.
- These bits offer the best combination of hardness and toughness to provide a long lasting tool.
- Standard steel shank not heat treated will not damage drill.
- Bits are “colour-coded” for easy selection.

PRO-IMPACT™



■ Square + Phillips

022-006

#0 #1 #2 #3



Part No.	Size	Description	Package Qty	Packs/Rack
140-811 / 812 / 813	#1 x 1", #2 x 1", #3 x 1"	Green/Red/Black Square Driver Bits	2	5
140-820 / 821 / 823	#0 x 2", #1 x 2", #3 x 2"	Yellow/Green/Black Square Driver Bits	1	5
140-822	#2 x 2"	Red Square Driver Bits	1	10
140-842	#2 x 4"	Red Square Driver Bits	1	5
140-871 / 872 / 873	#1 x 6", #2 x 6", #3 x 6"	Green/Red/Black Square Driver Bits	1	5
140-921 / 923 / 924	#1 x 2", #3 x 2", #2 x 2"	Green/Black/Red Phillips Driver Bits	1	5
222-356	1/4 x 3"	Magnetic Bit Holder	1	5
222-372	1"	Bit Magnetizer	1	5
222-383	1/4 x 3"	Quick Change Magnetic Holder	1	5
222-386 / 387	#2 Phillips/Square	Drywall/Deck Screw Setter	1	5
222-570	1/4 x 2-9/16"	Red Magnetic Nut Setter	1	5
222-575	5/16 x 2-9/16"	Yellow Magnetic Nut Setter	1	5
222-589	1/4 x 6"	Red Magnetic Nut Setter	1	5
222-590	5/16 x 6"	Yellow Magnetic Nut Setter	1	5
222-591	3/8 x 6"	Blue Magnetic Nut Setter	1	5
8020-801	#1, 2, 3 x 2"	Square Driver Bit Kit	3	5
8020-940	1", 2"	Power Driver Bit Kit	14	5
8140-812	#2 x 1"	Red Square Driver Bits	25	3
8140-813	#3 x 1"	Black Square Driver Bits	10	3
8140-822	#2 x 2"	Red Square Driver Bits	10	5



**SOCKET KEY SET MERCHANDISER
PRÉSENTOIRS DE JEUX DE DOUILLES À CLÉS**

No. 022-015

The Socket Key Set Merchandising display is equipped with professional quality kits made with alloy tool steel and heat treated chrome alloy steel. This kit includes an attractive sign which can be modified for private branding & is suitable for display on a wall, pegboard, counter or gondola. A total of 36 Socket Key Kits are available. The rack comes with detachable pegs allow you to organize the kits to any format suited.

Bulk	Display Qty	Description
022-015	36	36 Piece Socket Key Set Merchandiser

CONTENT LISTING

Part	Quantity	Part	Quantity	Part	Quantity
140-515	4	140-530	4	140-625	4
140-520	4	140-615	4	140-626	4
140-521	4	140-620	4	140-630	4



022-015

720 PIECES BULK BIT MERCHANDISER PRÉSENTOIRS D'EMBOUTS EN VRAC, 720 MCX

No. 022-016

- 720 Pieces
- 14" wide x 15" deep x 8" high
- Complete with labels
- Hinged lid for easy access
- Complete with lock & key



022-016

No. 022-016

MERCHANDISER CONTENTS

The power bits and accessories included in the PRO-TIP® merchandiser are manufactured from high quality tool steel and heat treated for long life. The square recess bits are all 2 piece construction.

Contents of Bulk Merchandiser					
Part Number	Description	Quantity	Part Number	Description	Quantity
B140-310	#0 x 1"SQ	50	B140-411	#1 x 1" Phillips	50
B140-311	#1 x 1"SQ	50	B140-412	#2 x 1" Phillips	50
B140-312	#2 x 1"SQ	50	B140-413	#3 x 1" Phillips	50
B140-313	#3 x 1"SQ	50	B140-421	#1 x 2" Phillips	25
B140-321	#1 x 1"SQ	25	B140-424	#2 x 2" Phillips	25
B140-322	#2 x 2"SQ	25	B140-423	#3 x 2" Phillips	25
B140-323	#3 x 2"SQ	25	B140-360	1/4" x 1 7/8" MNS	10
B140-331	#1 x 3"SQ	20	B140-365	5/16" x 1 7/8" MNS	10
B140-332	#2 x 3"SQ	20	B140-366	3/8" x 1 7/8" MNS	10
B140-333	#3 x 3"SQ	20	B140-370	1/4" x 2 9/16" MNS	10
B140-342	#2 x 4"SQ	20	B140-375	5/16" x 2 9/16" MNS	10
B140-362	#2 x 6"SQ	20	B140-376	3/8" x 2 9/16" MNS	10
B140-422	Drywall	50	B140-355	1/4" x 3" MBH	10

COLOUR-CODED MERCHANDISER PRÉSENTOIRS À CODE COULEUR

No. 022-024

- 530 Pieces
- Square Recess
- Power Driver Bits
- May be private branded



022-024

Contents of Bulk Merchandiser					
Part Number	Description	Quantity	Part Number	Description	Quantity
B140-810	#0 x 1"SQ Yellow	50	B140-841	#1 x 4" SQ Green	20
B140-811	#1 x 1"SQ Green	50	B140-842	#2 x 4" SQ Red	20
B140-812	#2 x 1"SQ Red	50	B140-843	#3 x 4" SQ Black	20
B140-813	#3 x 1"SQ Black	50	B140-871	#1 x 6" SQ Green	20
B140-820	#0 x 2"SQ Yellow	25	B140-872	#2 x 6" SQ Red	20
B140-821	#1 x 2"SQ Green	25	B140-873	#3 x 6" SQ Black	20
B140-822	#2 x 2"SQ Red	25	B140-892	#2 x 12" SQ Red	10
B140-823	#3 x 2"SQ Black	25	Other Bits Included		
B140-831	#1 x 3"SQ Green	20	222-383	Quick Change Chuck	10
B140-832	#2 x 6"SQ Red	20	222-372	Magnetic Sleeve	10
B140-833	#3 x 3"SQ Black	20	222-385	#2 PH Drywall Dimpler	20

**COLOUR-CODED ROTATING BULK MERCHANDISER
PRÉSENTOIRS ROTATIFS À CODE COULEUR, PIÈCES EN VRAC**

No. 022-112

- 544 pieces
- Hardened and tempered S2 steel tip for extended life
- Shatter proof
- Durable to withstand high levels of torque
- Standard steel shank will not damage drill

PRO-IMPACT™

IMPACT DRIVER APPROVED

■ Square + Phillips

022-112 #0 #1 #2 #3



Pro-Tip 10 Pack Sleeves				
Part Number	Size	Description	Pkg Qty	Bit Qty
8020-980	#1, #2, #3 x 2"	Square/Phillips, Bits	10	120
8020-982	#0, #1, #2, #3 x 2"	Square Bits	10	120
8020-984	#1, #2, #3 x 2"	Phillips Bits	10	120
8020-986	#2 x 2"	Square/Phillips Bits	10	120

Pro-Tip Flagged Bits				
Part Number	Size	Description	Pkg Qty	Bit Qty
8140-831 / 832 / 833	#1, #2, #3 x 3"	3" Square Bits	1	8
8140-831 / 832 / 833	#1, #2, #3 x 2"	3" Phillips Bits	1	8
8140-831 / 832 / 833	#1, #2, #3 x 4"	4" Square Bits	1	8
8140-831 / 832 / 833	#1, #2, #3 x 4"	4" Phillips Bits	1	8
8140-831 / 832 / 833	#1, #2, #3 x 6"	6" Square Bits	1	8
8140-831 / 832 / 833	#1, #2, #3 x 6"	6" Phillips Bits	1	8
8140-831 / 832 / 833	#1, #2, #3 x 12"	12" Square Bits	1	8
8140-831 / 832 / 833	#1, #2, #3 x 12"	12" Phillips Bits	1	8

**COLOUR-CODED SQUARE RECESS POWER DRIVER BITS
EMBOUS CARRÉS POUR TOURNEVIS ÉLECTRIQUE, CODE COULEUR**

1/4" HEX SHANK



1" Long 2" Long

3" Long

4" Long

6" Long

0	
1	
2	
3	

140-822
Card

140-812
Clamshell

* Available in 12" Lengths

Card Part #	Clamshell Part #	Bulk Part #	Size	Description
1" Long (Carded with 2 bits-1 pc / Clam-10 pcs / Bulk-100 pcs, *23pcs)				
140-811		B140-810	#0 x 1"	Yellow
140-812	8140-812	B140-811	#1 x 1"	Green
140-813	8140-813	B140-812	#2 x 1"	Red
		B140-813	#3 x 1"	Black
2" Long (Carded -1 pc / Clam-10 pcs / Bulk-100 pcs)				
140-820		B140-820	#0 x 2"	Yellow
140-821	8140-822	B140-821	#1 x 2"	Green
140-822		B140-822	#2 x 2"	Red
140-823		B140-823	#3 x 2"	Black
3" Long (Bulk-100 pcs)				
		B140-831	#1 x 3"	Green
		B140-832	#2 x 3"	Red
		B140-833	#3 x 3"	Black
4" Long (Carded - 1 pc / Bulk-50 pcs)				
140-842		B140-841	#1 x 4"	Green
		B140-842	#2 x 4"	Red
		B140-843	#3 x 4"	Black
6" Long (Carded - 1 pc / Bulk-25 pcs)				
140-871		B140-871	#1 x 6"	Green
140-872		B140-872	#2 x 6"	Red
140-873		B140-873	#3 x 6"	Black
12" Long (Bulk-10 pcs)				
		B140-891	#1 x 12"	Green
		B140-892	#2 x 12"	Red
		B140-893	#3 x 12"	Black

COLOUR-CODED PHILLIPS RECESS POWER DRIVER BITS EMBOUS PHILLIPS À TÊTE CREUSE, À CODE COULEUR POUR PERCEUSE ÉLECTRIQUE

1/4" HEX SHANK

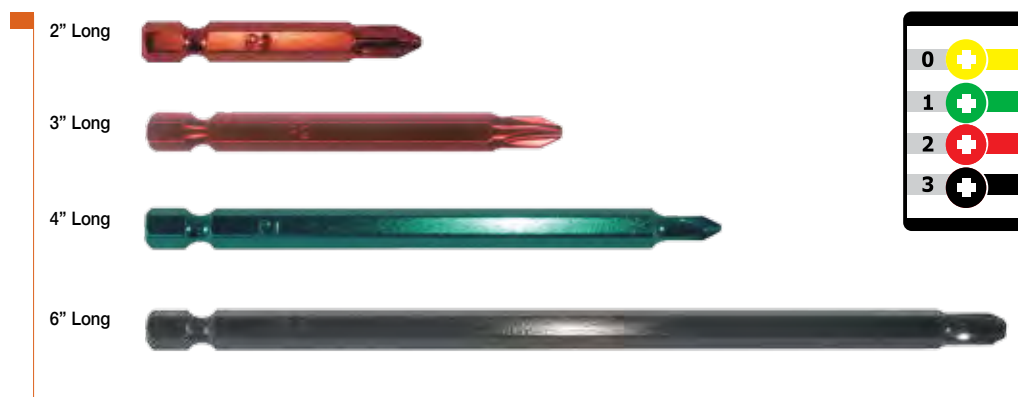

140-924

Card

* Available in 12" Lengths

Carded Part #	Bulk Part #	Size	Description
1" Long (Bulk-100 pcs)			
	B140-911	#0 x 1"	Green
	B140-912	#2 x 1"	Red
	B140-913	#3 x 1"	Black
2" Long (Carded -1 pc / Bulk-100 pcs)			
140-921	B140-921	#1 x 2"	Green
140-924	B140-924	#2 x 2"	Red
140-923	B140-923	#3 x 2"	Black
3" Long (Bulk-100 pcs)			
	B140-931	#1 x 3"	Green
	B140-932	#2 x 3"	Red
	B140-933	#3 x 3"	Black
4" Long (Bulk-50 pcs)			
	B140-941	#1 x 4"	Green
	B140-942	#2 x 4"	Red
	B140-943	#3 x 4"	Black
6" Long (Bulk-25 pcs)			
	B140-971	#1 x 6"	Green
	B140-972	#2 x 6"	Red
	B140-973	#3 x 6"	Black
12" Long (Bulk-10 pcs)			
	B140-991	#1 x 12"	Green
	B140-992	#2 x 12"	Red
	B140-993	#3 x 12"	Black

**MAGNETIC NUTSETTER MERCHANDISER
PRÉSENTOIRS DE TOURNE-ÉCROUS MAGNÉTIQUES**

222
Series

No. 022-111

- 45 pieces
- The PRO-TIP[®] Nutsetter with its permanent high strength Alnico magnet is manufactured from high quality tool steel and heat treated for long life.
- Unique point of purchase display
- Includes 45 of the most popular Magnetic Nutsetters
- Shatter proof
- Private Branding Available

IMPACT READY

Part Number	Qty	Size	Ref. Hex Opening	Socket Body Dia.
222-389	3	1/4 x 6	1/4	7/16
222-390	3	5/15 x 6	5/16	1/2
222-391	3	3/8 x 6	3/8	9/16
222-392	3	7/16 x 6	7/16	5/8
222-393	3	1/2 x 6	1/2	3/4
222-370	3	1/4 x 2-9/16	1/4	7/16
222-375	3	5/16 x 2-9/16	5/16	1/2
222-376	3	3/8 x 2-9/16	3/8	9/16
222-377	3	7/16 x 2-9/16	7/16	5/8
222-378	3	1/2 x 2-9/16	1/2	3/4
222-360	3	1/4 x 1-7/8	1/4	7/16
222-365	3	5/16 x 1-7/8	5/16	1/2
222-366	3	3/8 x 1-7/8	3/8	9/16
222-367	3	7/16 x 1-7/8	7/16	5/8
222-368	3	1/2 x 1-7/8	1/2	3/4

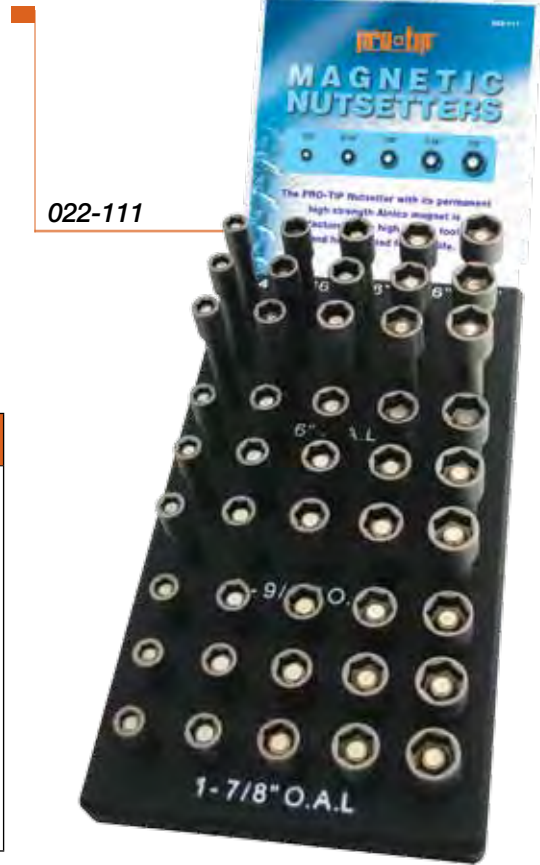

**MAGNETIC NUTSETTER
INSTALLERS MAGNÉTIQUE D'ÉCROUS**



Papco[®] Nutsetters with a permanent high-strength Alnico magnet are manufactured from high quality tool steel and heat treated for long life.

ORDER BY STOCK NUMBER			1/4 Hex Shank		Individually Packaged	
Stock No.	Size x Overall Length	Socket Body Dia.	Stock No.	Size x Overall Length	Socket Body Dia.	
222-360	1/4 Hex x 1-7/8	7/16	222-370	1/4 Hex x 2-9/16	7/16	
222-365	5/16 Hex x 1-7/8	1/2	222-375	5/16 Hex x 2-9/16	1/2	
222-366	3/8 Hex x 1-7/8	9/16	222-376	3/8 Hex x 2-9/16	9/16	
222-367	7/16 Hex x 1-7/8	5/8	222-377	7/16 Hex x 2-9/16	5/8	
222-368	1/2 Hex x 1-7/8	11/16	222-378	1/2 Hex x 2-9/16	11/16	

7/16 Magnetic Bit Holder - 303 Stainless Steel
Available in Bulk - price on application.

BIT ACCESSORIES ACCESSOIRE DE POINTES

222
Series

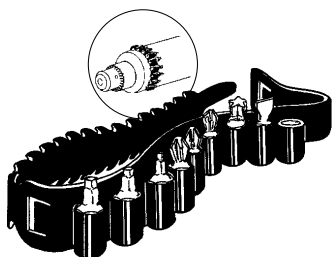

222-380

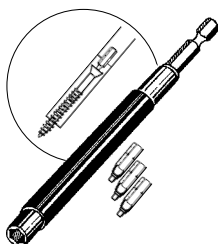

222-382

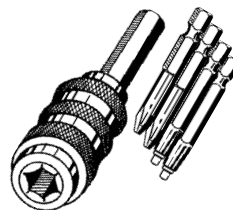

222-384



222-385



ORDER BY STOCK NUMBER

Individually Skin-packed

Stock No.	Description
222-380	Power Bit Belt - straps to most power drills - Includes 9 assorted bits including 6-Lobe
222-382	Screw Starter Driver - sliding guide sleeve over magnetic chuck - includes 3 square drive bits
222-384	Quick Change Chuck - includes four 2" long assorted Loxxon® and Phillips bits (No. 1 and 2 Points)
222-385	Drywall Screw Dimpler - includes Drywall Screw Bit

QUICK CHANGE COLOUR BIT KIT ENSEMBLE D'EMBOUITS DE COULEURS À INTERCHANGE RAPIDE

8020
Series

No. 8020-922

■ 18 pieces

Size	Kit Content	Qty	Size	Kit Content	Qty
	Quick Change Magnetic Holder	1	#3	Colour-coded Square 2" Bit	1
#0	Colour-coded Square 1" Bit	1	1/4	Magnetic Nut Setter 2-9/16"	1
#1	Colour-coded Square 1" Bit	1	5/16	Magnetic Nut Setter 2-9/16"	1
#2	Colour-coded Square 1" Bit	1	3/8	Magnetic Nut Setter 2-9/16"	1
#3	Colour-coded Square 1" Bit	1	7/16	Magnetic Nut Setter 2-9/16"	1
#1	Phillips Driver Bit	1	1/2	Magnetic Nut Setter 2-9/16"	1
#2	Phillips Driver Bit	1			
#3	Phillips Driver Bit	1			
T-15	Phillips Driver Bit	1			
#1	Colour-coded Square 2" Bit	1			
#2	Colour-coded Square 2" Bit	1			

Kit Part #	Case Qty
8020-922	20

* Private Branding Available



**NUTSETTER AND BIT KIT
ENSEMBLE D'EMBOUS ET TOURNE-ÉCROUS**

8020
Series

No. 8020-923

- 24 pieces
- Professional Bit Kit for all your driving requirements.
- Includes most popular square, phillips, six lobes and slot drive bits in 1", 2", 4" and 6" lengths.
- All square drive bits are 2 piece S-2 steel construction.
- Also includes 4 magnetic nut setters with permanent high strength Rare Earth Magnet.
- Nut Setters have hexagon shank for positive drive and fit any standard electric drill.
- Magnetic bit holder with high strength Alnico magnet.

Kit Part #	Case Qty	Kit Part #	Case Qty
8020-923	1	8020-924	12

* Private Branding Available

* Also Available P.O.P. Display 12 pcs - 8020-924



8020-923 (KIT)



8020-924 (P.O.P.)

**62 PC ULTIMATE BIT KIT
ENSEMBLES ULTIMES D'EMBOUS PCES 62**

No. 8020-930

- 62 pieces
- All square recess bits are 2 piece S-2 steel construction and colour-coded for easy selection
- Heavy duty compact case with rubber bumpers
- Magnetic quick change chuck has a high strength Rare Earth Magnet

	Size	Kit Content	Qty
■	1"	Square Colour-Coded Bits	14
+	1"	Phillips Bits	13
⬠	1"	Six-Lobe Bits	10
⬠	1"	Allen Bits	4
—	1"	Slot Security Bits	3
⬠	1"	Six-Lobe Security Bits	10
⬠	1"	Phillips Security Bits	2
⬠	1"	Spanner Security Bits	4
		Magnetic Quick Change Chunk	1
		Socket Adapter	1



8020-930

Kit Part #	Case Qty
8020-930	20

* Private Branding Available

COLOUR-CODED COUNTER TOP BIT JAR POT D'EMBOUITS À CODE COULEUR POUR COMPTOIR

8020
Series

No. 8020-937 **PRO-IMPACT™**

- The Pro-Tip® two piece square recess power bit has a heat treated S-2 alloy steel tip swagged into a steel body shank.
- The tip is cold formed under rigid dimensional control to ensure a “Cling Fit” with the screw recess.
- These bits offer the best combination of hardness and toughness to provide a long lasting tool.
- Bits are “colour-coded” for easy selection.

Kit Part #	Case Qty
8020-937	1

JAR CONTENT			QTY
	#1	GREEN	# 1 x 2” Green Square Driver Bits 50
	#2	RED	# 2 x 2” Red Square Driver Bits 200
	#3	BLACK	# 3 x 2” Black Square Driver Bits 50

8020-937



COLOUR CODED POCKET TOOL KITS ENSEMBLES D'OUTIL DE POCHE À CODE COULEUR

No. 8020-941 COLOUR-CODED BITS

No. 8020-943 SECURITY BITS

- 13 pieces

Kit Part #	Pkg Qty
8020-941	13 pcs Security
8020-943	13 pcs Colour-Coded

Spanner Bits 8020-941

Overall Length 1”	
Size	Qty
4	1
6	1
8	1
10	1
12	1

* Private Branding Available

6-Lobe Security 8020-941

Overall Length 1”	
Size	Qty
T-10	1
T-15	1
T-20	1
T-25	1
T-27	1
T-30	1
T-40	1

* Private Branding Available

Colour Coded 8020-943

Overall Length 1”	
Size	Qty
#0 Yellow	1
#1 Green	2
#2 Red	3
#3 Black	2
#1 Phillips	1
#2 Phillips	1
3/16 Slot	1
T-15 6-Lobe	1

* Private Branding Available



8020-941

8020-943

**SCREWDRIVER BIT SET
ENSEMBLE D'EMBOUITS POUR TOURNEVIS**

8020
Series

No. 8020-944 Pro-Tip[®] 61 Piece Screw Driver Bit Set

- 61 pieces
- Driver bit assortment includes most popular phillips, square, slotted hex, and six-lobe drive bits
- Magnetic bit holder
- Convenient and compact storage case
- Content:
 - Phillips: #0 (2), #1 (2), #2 (4), #3 (2)
 - Square: #0 (3), #1 (3), #2 (3), #3 (3)
 - Slotted: 3, 4, 4.5, 5, 5.5, 6, 6.5, 7 mm
 - Hex : 1.5, 2, 2.5, 3, 3.5, 4, 4.5, 5, 5.5, 6 mm, 1/16", 5/64", 3/32", 7/64", 1/8", 9/64", 5/32", 3/16", 7/32", 1/4"
 - Six-Lobe : T8, T9, T10, T15, T20, T25, T27, T30, T35, T40



8020-944

**ASSORTED NUTSETTERS KITS
JEUX D'INSTALLER D'ÉCROUS**



1-7/8" Kit

No. 8020-987
Contains one each of 1/4, 5/16 and 3/8 Hex Magnetic Nutsetters in a clear tamper-proof pack.



2-9/16" Kit

No. 8020-988
Contains one each of 1/4, 5/16 and 3/8 Hex Magnetic Nutsetters in a clear tamper-proof pack.

020
Series

**BIT KIT
ENSEMBLES D'EMBOUITS**

**29 PCS BIT KIT
No. 020-929**

The power bits and accessories in the PRO-TIP[®] 29 Piece Bit Kit are manufactured from high quality tool steel and heat treated for long life. All square recess bits are 2 piece S-2 steel construction.



020-929

- Content:
 - #0, 1, 2, & 3 Phillips Insert Bits
 - 4-5, 6-8, 8-10, 10-12, & 12-14 Slot Insert Bits
 - #0, 1, 2, & 3 Square Insert Bits
 - #10, 15, 20, 25, 30 & 40 Six Lobe Insert Bits
 - #1 & #2 Pozidriv[®] Insert Bits
 - 5/64, 3/32, 1/8, 5/32 & 3/16 Socket Head Insert Bits
 - 1/4 HEX x 1/4 SQ. Extension/Adapter
 - 2" Magnetic Bit Holder
 - Screwdriver with storage capacity in handle

For complete Pro-Tip[®] guide see current Pro-Tip[®] catalogue

AN INTRODUCTION TO...

BODY SHOP FASTENERS

ATTACHES À CARROSSERIE

...UNE INTRODUCTION.

www.hpaulin.com

For a full listing of Papco®
Body Shop Fasteners, please
refer to our current catalogue or
visit our website to download a
PDF version.



SPEED CLIPS & NUTS

'PALNUTS'

RETAINERS

'PUSHNUT' METRIC
FASTENERS

'U' NUTS (MULTI & SINGLE
THREADS)

BODY BOLTS

BUMPER BAR BOLTS

'CONELOK' LOCKNUTS

LICENCE PLATE BOLTS

MOULDING BOLTS & CLIPS

RIVETS

GLASS SHOP FASTENERS

TRIM FASTENERS

WEATHERSTRIP FASTENERS

ANCHOR NUTS & CLIPS

PLUG BUTTONS

SHIMS

HINGE PINS & BUSHINGS

BLIND WELL NUTS

SERT-A-NUTS



FLAT TYPE SPEED NUTS
ÉCROUS TENIR TYPE FRAISÉE

240
Series



Used with machine screws and sheet metal screws. One piece, heat treated spring steel self-locking fastener. The original equipment fastener used on headlights, radiators, moulding, trim, gravel deflectors, ornaments, emblems, name plates, etc.

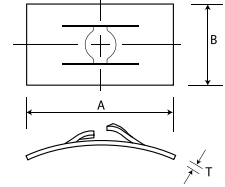

FLAT TYPE

ORDER BY STOCK NUMBER

Standard Package: Contains 100 Pieces



240-089
240-100



240-091
240-101



240-120
240-159



240-108
240-127

ILLUSTRATIONS ARE APPROXIMATE

Stock No.	Screw Size	Dimensions					Other No.	Application
		A	x	B	x	T		
240-089	6-32	1/2	x	5/16	x	.017	2089	General Purpose.
240-091	6-32	7/8	x	1/2	x	.017	1898	Chrysler products garnish moulding ornament.
240-100	8-32	1/2	x	5/16	x	.017	2091	General Purpose.
240-101	8-32	7/8	x	1/2	x	.017	1899	Chrysler products radiator and trunk medallion.
240-120	10-24	3/4	x	7/16	x	.022	2092	General Purpose.
240-159	1/4-20	1	x	9/16	x	.027	1903	General Purpose.
240-108	No. 8	5/8	x	11/32	x	.031	3793	For sheet metal screws.
240-127	No. 10	7/8	x	1/2	x	.031	1900	For sheet metal screws, and radiator grille.

GARAGE ASSORTMENT

No. 020-015

Contains 8 sizes of Flat Type Speed Nuts, 160 pieces. Packed in handy, clear plastic box, with moulded compartments.



FORMED TYPE SPEED NUTS ÉCROUS TENIR TYPE FORME

240
Series

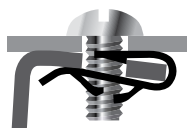

Used with machine screws and sheet metal screws. Two types, 'U' and 'J'. Press into locked on position over panel edge or in centre-panel location. Holds itself in screw receiving position.

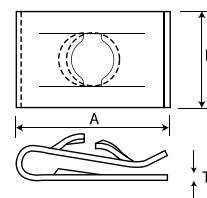

'J' Types

'U' Types



ORDER BY STOCK NUMBER

Standard Package Contains 100 Pieces

Stock No.	Screw Size	Type	Dimensions				Other No.	Application	
			A	x	B	x			T
240-243	10-24	U	41/64	x	7/16	x	.020	5197	General Purpose.
240-263	1/4-20	U	63/64	x	1/2	x	.025	2293	Licence Plate attaching nut.
For Sheet Metal Screws									
240-226	No. 8	U	31/64	x	1/2	x	.028	3796	Chevrolet Headlamp adj. nut, radiator grille assembly.
240-228	No. 8	U	41/64	x	7/16	x	.028	10666	Ford quarter trim to panel.
240-232	No. 8	U	3/4	x	7/16	x	.029	11292	General purpose.
240-242	No. 10	J	1	x	1/2	x	.035	8341	General purpose.
240-247	No. 10	J	15/32	x	11/16	x	.031	2303	Chevrolet Headlamp to fender.
240-250	No. 10	U	3/4	x	1/2	x	.031	2422	Ford radiator grille.
240-266	No. 12	U	7/8	x	9/16	x	.034	1910	General purpose.
240-267	No. 14	J	7/8	x	9/16	x	.034	2420	Oldsmobile. front fender radiator to grille 3/32 panel.
240-268	No. 14	J	7/8	x	9/16	x	.034	2057	Oldsmobile. Pontiac, fender and radiator 3/64 panel.
240-274	1/4-20	J	7/8	x	5/8	x	.300	5586	General purpose 'J' Type Cage Nut
240-276	5/16-18	J	1-1/16	x	3/4	x	.300	5589	General purpose 'J' Type Cage Nut
240-278	3/8-16	J	1-1/8	x	3/4	x	.300	5170	General purpose 'J' Type Cage Nut

GARAGE ASSORTMENT

No. 020-016

Contains 8 sizes of 'U' and 'J' Formed Type Speed Nuts, 65 pieces. Packed in handy, clear plastic box with compartments.



**PUSH-ON TYPE SPEED NUTS
ÉCROUS TENIR TYPE POUSSÉE**

**240
Series**



For use on studs, rivets and other unthreaded parts. Teeth bite inward and arched shape provides secure spring grip.

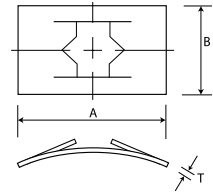

FLAT TYPE

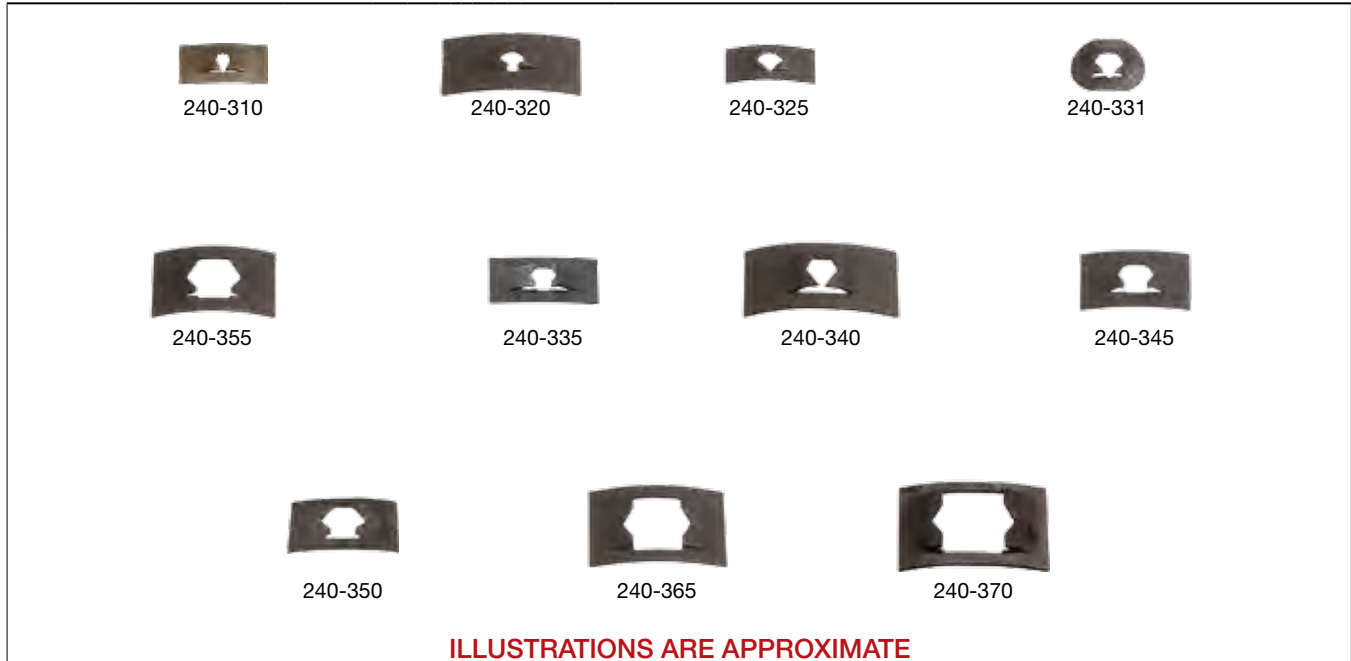

ORDER BY STOCK NUMBER

Standard Package Contains 100 Pieces

Stock No.	Screw Size	Dimensions					Other No.	Application
		A	x	B	x	T		
240-310	1/16	25/64	x	7/32	x	.012	2098	Buick seat trim, Chrysler name plate.
240-320	3/32	7/16	x	7/32	x	.017	2100	For Hardened Studs, Pontiac name plate.
240-325	.100	29/64	x	15/64	x	.014	1906	General Purpose.
240-331	1/8	3/8	x	11/32	x	.019	3559	General Purpose.
240-335	1/8	37/64	x	5/16	x	.012	2099	General Purpose.
240-340	5/32	3/4	x	7/16	x	.020	1905	General Purpose.
240-345	5/32	9/16	x	3/8	x	.012	2102	General Purpose.
240-350	3/16	5/8	x	3/8	x	.017	2103	Ford products name plate, ornament.
240-355	1/4	41/64	x	7/16	x	.017	2105	General Purpose.
240-365	5/16	3/4	x	17/32	x	.020	3138	General Purpose.
240-370	3/8	13/16	x	5/8	x	.020	3139	General Purpose.

GARAGE ASSORTMENT

No. 020-017

Contains 7 sizes of Push-On Type Speed Nuts, 160 pieces. Packed in a rigid clear plastic container with handy compartments.



TUBULAR TYPE SPEED CLIPS ÉCROUS TENIR TYPE À TUBE

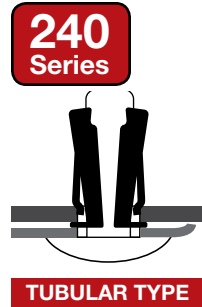

Used on unthreaded studs and rivets where there is access to only one side of the assembly. Insert speed clips into hole causing cam-like side prongs to snap and hold clip in proper position. Push rivet end into clip causing turned-in end of clip to bite rivet and lock it securely.

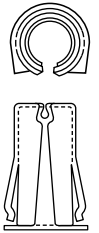

ORDER BY STOCK NUMBER

Standard Package: contains 100 Pieces



ILLUSTRATIONS ARE APPROXIMATE

Stock No.	Stud Dia.	Panel Range	Fits Hole	Other No.	OEM No.
240-430	1/8	.030 - .036	5/32	2611	—
240-431	1/8	.040 - .045	3/16	2595	—
240-432	1/8	.036 - .046	1/4	5195	375480-S100, 3783794
240-471	3/16	.038 - .044	7/32	10073	6000558

GARAGE ASSORTMENT

No. 020-018

Contains 4 sizes of Tubular Speed Clips, for studs, 70 pieces. Packed in clear plastic container with easy to use compartments.

020-018



UTILITY ASSORTMENTS

No. 020-315

FLAT TYPE

8 sizes for Machine and Sheet Metal Screws, 325 pieces.



020-315

No. 020-316

FORMED TYPE

10 sizes, 'U' and 'J' types for Machine and Sheet Metal Screws, 110 pieces.



020-316

No. 020-317

PUSH-ON & TUBULAR

14 sizes for unthreaded Studs, 275 pieces.



020-317

All Papco[®] Utility Assortments are packed in sturdy fibreboard metal-edged boxes with individual compartments and with illustrated labels showing parts and prices.

**SPEED NUT MASTER ASSORTMENTS
ASSORTIMENTS D'ÉCROUS TENIR**

No. 020-643

For unthreaded studs. Contains 3 Sizes Tubular Speed Clips. 14 Sizes Push-On Speed Nuts. 477 pieces selected according to popularity. Name plates, emblems, moulding clips are held with Tubular Speed Clips and Push-on Speed Nuts. These kits will service every need that will come up in your shop.

020-643



No. 020-644

For machine and sheet metal screws. Contains 8 Sizes Flat Type Speed Nuts, 11 Sizes Formed Type Speed Nuts 421 pieces balanced for popularity. Every year more and more Speed Nuts are used for Original Equipment attachments. These handy kits contain the Speed Nuts that are most frequently replaced on all makes of cars. Size: 9-34" W x 13-3/4" L x 2" D.

020-644



**SPEED NUT 'SUPER-SERVICE' ASSORTMENT
ASSORTIMENT DE 'SUPER-SERVICE' D'ÉCROUS TENIR**

No. 020-810

Ideal for Dealers, Jobbers and large users. This popular assortment contains a wide range of Flat Push-on and Formed Type Speed Nuts carefully selected in balanced quantities.

Size: 12" W x 18" L x 3" D.

- Contains 685 Speed Nuts in Flat, Push-on and Formed Types – 32 sizes.
- Large size, rigid metal box with high-strength plastic compartments.
- Convenient, safety snap carrying handle.
- Actual size illustrations and retail codes of every item shown on grease-resistant lid label.
- Refills available in standard packages.

020-810



'PALNUT' LOCK NUTS ÉCROUS À BLOCAGE 'PALNUT'

242
Inch

243
Metric

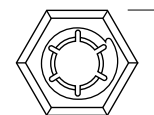

Regular Type, Bright Zinc Plated

Spring steel, single thread lock nuts. May be used alone or on top of ordinary nuts.

ORDER BY STOCK NUMBER

Standard Package: 50 Pieces

Stock No.	Size & Thread	Across Flats 'W'	Stock No.	Size	Across Flats 'W'
Inch			Metric		
242-016	5/16-24	1/2	243-004	M4	9 mm
242-018	3/8-24	9/16	243-005	M5	13 mm
242-020	7/16-20	5/8			
242-022	1/2-20	3/4			

Hex Washer Type, Bright Zinc Plated

Integral washers on these lock nuts span slots or clearance holes. This spring locking action of the washer provides a secure assembly.

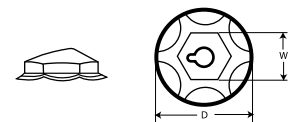

ORDER BY STOCK NUMBER

Standard Package: 50 Pieces

Stock No.	Size & Thread	'W' x 'D'	Stock No.	Size	'W' x 'D'
Inch			Metric		
242-108	8-32	11/32 x 5/8	243-105	M5	10 mm x 13 mm
242-110	10-24	3/8 x 3/4	243-106	M6	11 mm x 18 mm
242-114	1/4-20	7/16 x 11/16			
242-116	5/16-18	1/2 x 13/16			

GARAGE ASSORTMENT

No. 020-074

Contains 100 pieces of all Inch sizes of 'Palnut' Lock Nuts in both regular and washer types. Packed in a clear, plastic box.

No. 020-075

Contains 100 pieces of all Metric size 'Palnut' Lock Nuts in both regular and washer types. Packed in a clear, plastic box.

020-075



SELF-THREADING 'PALNUTS' 'PALNUTS' À FILETAGE COUPANT

These washer base, heat treated nuts cut their own threads on plain studs, nameplates, ornaments and mouldings.

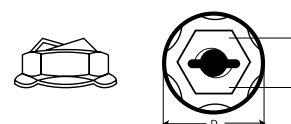

ORDER BY STOCK NUMBER

Standard Package: 50 Pieces

Stock No.	Stud Size	Type	'W' x 'D'	Stock No.	Stud Size	Type	'W' x 'D'
Bright Zinc plated				Bright Zinc plated			
242-206	1/8	Regular	5/16 x 7/16	242-214	1/4	Regular	7/16 x 11/16
242-208	5/32	Regular	11/32 x 9/16	242-216	5/16	Regular	1/2 x 7/8
242-210	3/16	Regular	3/8 x 1/2				

METRIC SELF-THREADING 'PALNUTS' 'PALNUTS' À FILETAGE COUPANT MÉTRIQUE

ORDER BY STOCK NUMBER

Standard Package: 50 Pieces

Stock No.	Stud Size	Type	W x D	Stock No.	Stud Size	Type	W x D
Bright Zinc plated							
243-204	4 mm	Regular	9 mm x 15 mm	243-205	5 mm	Regular	10 mm x 15 mm

GARAGE ASSORTMENT

No. 020-052

Contains 100 nuts of 1/8", 5/32", 3/16", 1/4" and 5/16" Self-Threading 'Palnuts'. Packed in a clear, plastic box.

020-052



**BOLT RETAINERS
RETENUES DE BOULON**

242
Inch

243
Metric

Black Phosphate Finish

These fasteners are pushed onto a screw or bolt of either coarse or fine thread to hold it in place during assembly. When the regular nut is tightened the retainer is left in place.

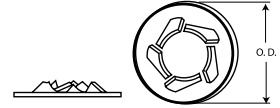

ORDER BY STOCK NUMBER

Standard Package: 100 Pieces

Stock No.	Screw or Bolt Dia.	Outside Diameter
Inch		
242-308	5/32	3/8"
242-310	3/16	7/16"
242-314	1/4	1/2"
242-316	5/16	5/8"
242-318	3/8	25/32"
242-320	7/16	27/32"
242-322	1/2	15/16"

Stock No.	Screw or Bolt Dia.	Outside Diameter
Metric		
243-305	M5	11.0 mm
243-306	M6	17.0 mm
243-307	M6.3	14.3 mm
243-308	M8	25.0 mm
243-310	M10	24.0 mm
243-312	M12	21.4 mm

GARAGE ASSORTMENT

No. 020-076

Contains 100 inch retainers in 1/4", 5/16", 3/8", 7/16" and 1/2". Packed in a sturdy, transparent plastic box.

No. 020-077

Contains 100 metric retainers in M6, M8, M10 and M12. Packed in a clear, plastic, compartmentalized box.



020-077

**'PUSHNUT' FASTENERS
ATTACHES 'PUSHNUT'**

Bright Zinc Plated

These flat, round type, spring steel fasteners are pushed on unthreaded rods, studs, etc. Used on nameplates, moulding studs and shafts.

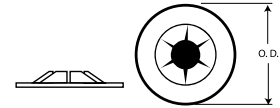

ORDER BY STOCK NUMBER

Standard Package: 100 Pieces

Stock No.	Stud Size	Outside Diameter	Stock No.	Stud Size	Outside Diameter
242-401	1/16	.195	242-413	.240	17/32
242-403	3/32	.195	242-414	1/4	17/32
242-406	1/8	3/8	242-416	5/16	5/8
242-408	5/32	7/16	242-418	3/8	3/4
242-410	3/16	7/16	242-422	1/2	1

**METRIC 'PUSHNUT' FASTENERS
ATTACHES 'PUSHNUT' MÉTRIQUE**

ORDER BY STOCK NUMBER

Standard Package: 100 Pieces

Stock No.	Stud Size	Outside Diameter	Stock No.	Stud Size	Outside Diameter
243-403	3.2 mm	9.5 mm	243-405	5.0 mm	11.0 mm
243-404	4.0 mm	11.0 mm			

GARAGE ASSORTMENT

No. 020-084

Contains 100 'Pushnut' Fasteners in both inch and metric - 10 sizes in all. Packed in a transparent plastic box with hinged lid.

020-084



MASTER ASSORTMENT

No. 020-674

Contains 325 pieces - 20 popular sizes of Regular and Self-Threading Palnuts plus Bolt Retainers and 'Pushnuts'. Packed in a Metal box with moulded plastic compartments.

020-674

9-3/4" W x 13-3/4" L x 2" D.



'SUPER-SERVICE' ASSORTMENT

No. 020-811

Contains 500 Regular and Self Threading Palnuts plus Bolt Retainers and 'Pushnuts' - 32 items. Large size, rigid metal box with high-strength plastic compartments.

For more details see page 10.

020-811

18" L x 3" D.



**MULTI-THREAD 'U' NUTS
ÉCROUS 'U' FILET MULTIPLE**

240
Inch

241
Metric

Phosphate Coated
Spring Steel nut fastens two panels, is retained in one panel. Used for sheet metal and front end assembly on GM, Ford or Chrysler fenders, shrouds and radiators, etc.

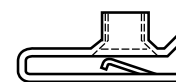
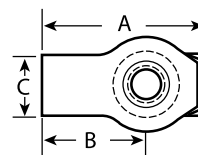

ORDER BY STOCK NUMBER

Standard Package: 25 Pieces (*10 Pieces)

Stock No.	Bolt or Screw Size	Length 'A'	Throat Depth 'B'	Width 'C'	Panel Thickness	OEM No.	Stock No.	Bolt or Screw Size	Length 'A'	Throat Depth 'B'	Width 'C'	Panel Thickness	OEM No.
240-615	1/4-20	1.250	0.8125	0.520	0.150	45267, 1494257	241-605	M4 x .7	22.0	14.5	10.0	3.8	11500655
240-616	5/16-18	0.980	0.580	0.580	0.150	6023171-45264	241-606	M6 x 1.0	24.0	13.7	13.0	4.0	11503957, 1016937, N623332-S2, N623332-S53, N623332-S100
240-617	5/16-18	1.250	0.875	0.580	0.150	379831-S, 1494258	241-607	M6 x 1.0	30.0	20.0	13.0	4.0	11503715, 11508241, 11609385
240-618	3/8-16	1.670	1.100	0.720	0.200	45269	241-608	M8 x 1.25	32.0	21.5	14.7	4.0	11500661, 11503317, 11516150, N623343-S2, N623343-S100
240-619	3/8-16	1.3125	0.750	0.9375	0.200	1494254, 45265-S2, 12337873	241-609	M8 x 1.25	25.5	15.0	14.7	4.0	11500660, 11502617, N623333-S2, 6101283
240-614	1/4-20	0.920	0.540	0.520	0.150	1480627, 1494252	241-610*	M10 x 1.5	33.0	19.0	18.0	6.0	11500662, 22531616
241-604	M4 x .7	21.5	10.5	11.0	3.8	N623330-S2, 11500654	241-612	M6.3 x 1.0	24.0	20.0	13.5	4.0	11500658, 9433043

For Body Bolts see page 142.

GARAGE ASSORTMENT

No. 020-078

Contains 65 Inch Multi-Thread 'U' Nuts. 4 sizes each in its own compartment. Packed in a sturdy, transparent plastic box with hinged lid.

No. 020-079

Contains 50 Metric Multi-Thread 'U' Nuts. 7 sizes packed in a clear plastic box with hinged lid.



020-079

**SINGLE THREAD 'U' NUTS
ÉCROUS 'U' FILET-UNE**

240
Inch

Phosphate Coated

ORDER BY STOCK NUMBER

Standard Package: 25 Pieces

Stock No.	Screw Size	Length 'A'	Throat Depth 'B'	Width 'C'	Panel Thickness	OEM No.	Stock No.	Screw Size	Length 'A'	Throat Depth 'B'	Width 'C'	Panel Thickness	OEM No.
240-706	No. 6	0.890	0.375	0.575	0.125	—	240-714	No. 14	0.785	0.344	0.650	0.156	45258
240-708	No. 8	0.785	0.375	0.550	0.125	9424837, 9431530; 381818-S2	240-715	No. 14	1.000	0.563	0.650	0.156	45261
240-709	No. 8	1.000	0.625	0.550	0.125	9440178, 11504531, 381863-S2	240-717	No. 8	0.430	0.219	0.325	0.109	25527289
240-710	No. 10	0.785	0.344	0.650	0.125	152492	240-726	M6.3	0.988	0.845	0.640	0.340	—

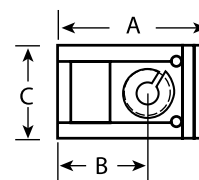

GARAGE ASSORTMENT

No. 020-080

Contains 65 Single Thread 'U' Nuts. 5 sizes packed in a transparent plastic box with hinged lid.



020-080

MASTER ASSORTMENT

No. 020-692

Contains 100 'U' Nuts in both Multi-Thread and Single Thread types. Packed in a metal box with high-strength plastic compartments. Total of 20 sizes inch, metric for complete coverage.



020-692

**BODY BOLTS
BOULONS DE CARROSSERIE**

**245
Series**

Special Indented Hexagon Head Bolts with aligning points for pre-drilled panels. Phosphate finish.



TYPE 1
Conical Washer
Head Dog-Point



TYPE 2
Conical
Washer Head



TYPE 3
Hex Washer
Head



TYPE 4
Hex Head
Sems

ORDER BY STOCK NUMBER

Standard Package: 25 Pieces (*15 Pieces)

Stock No.	Size	Type	Washer O.D.	OEM No.	Stock No.	Size	Type	Washer O.D.	OEM No.
245-310	M4.2-1.41 x 20mm	4	12mm	11504056, 11513801	245-441	M8-1.25 x 30mm	3	17mm	11500971
245-315	M6-1.0 x 28mm	1	8mm	N606677-S43B	245-450*	M10-1.5 x 40mm	2	29mm	11501193
245-322	M6-1.0 x 22mm	1	8mm	N606676-S2, N606676-S100	245-505	M6-1.0 x 20mm	3	13mm	11503800
245-323	M6-1.0 x 28mm	1	19mm	N606677-S36	245-507	M6-1.0 x 25mm	3	13mm	11503958
245-324	M6-1.0 x 30mm	2	24mm	11503825	245-510	M6-1.0 x 35mm	3	17mm	11505044
245-325	M6-1.0 x 30mm	1	19mm	6100568	245-525	M8-1.25 x 25mm	3	17mm	11503632
245-326	M5-0.8 x 20mm	1	12mm	6100539	245-526	M8-1.25 x 25mm	2	24mm	11503619
245-400	M4.2-1.41 x 20mm	2	16mm	11500434, 11503892, 1640810	245-527	M8-1.25 x 30mm	3	17mm	11500971
245-405	M6-1.0 x 20mm	2	17mm	11502941, 11506174	245-321	1/4-20 x 7/8"	1	3/4"	57030-S2
245-407	M6-1.0 x 25mm	2	17mm	11503834, 20351035	245-610	1/4-20 x 1-1/4 S/S	3	5/8"	14007511, 367291, 474821
245-408	M6-1.0 x 25mm	2	24mm	11503982	245-614	5/16-18x13/16"	1	41/64"	3960314
245-420	M6.3-1.0 x 20mm	2	17mm	11501105	245-615	5/16-18 x 7/8"	2	3/4"	3846202
245-421	M6.3-1.81 x 20mm	4	18mm	—	245-616	5/16-18 x 1"	2	7/8"	3968521
245-424	M6.3-1.0 x 25mm	2	18mm	11500754	245-617	5/16-18 x 1"	1	13/16"	—
245-425	M6.3-1.0 x 25mm	2	24mm	365718	245-620	3/8-16 x 1"	2	1"	3986997, 14011722
245-439	M8-1.25 x 25mm	2	24mm	1503619	245-621	1/4-20 x 1"	1	5/8"	6025329
245-440	M8-1.25 x 30mm	2	24mm	11501188	245-630	3/8-16 x 1-1/2"	2	1-1/8"	407217, 1564180

For Body Bolt 'U' Nuts see page 141.

MASTER ASSORTMENT

No. 020-691

Contains 150 Body Bolts - 20 sizes. Packed in a metal box with high-strength plastic compartments. Every item is fully illustrated on a grease resistant lid label.

For Body Bolt & Nuts 'Super-Service' Assortment No. 020-834 see page 11.

020-691

9-3/4" W x 13-3/4" L x 2" D.



BUMPER BAR BOLTS BOULONS DE PARE-CHOC

245
Series

Stainless Steel Capped

Papco® Bumper Bar Bolts are capped with 18.8 Stainless Steel, carefully polished and buffed to a high lustre. All bolts are bright plated to resist rust.



Type 1
Semi-Round
Head



Type 2
Round
Head

Standard Package: contains 12 Bumper Bar Bolts and 12 Self-Locking Nuts * 6 Bumper Bar Bolts and 6 Self-Locking Nuts

ORDER BY STOCK NUMBER

Stock No.	Bolt Size	Type	Stock No.	Bolt Size	Type
245-146	1/4-20 x 3/4	1	245-172	7/16-14 x 1-1/4	1
245-150	5/16-18 x 7/8	1	245-173	7/16-14 x 1-1/2	1
245-153	5/16-18 x 1	1	245-175	7/16-14 x 2	1
245-160	3/8-16 x 3/4	1	245-177	7/16-14 x 2-1/2	1
245-161	3/8-16 x 3/4	2	245-179	7/16-14 x 3-1/2	1
245-164	3/8-16 x 1	1	245-182	1/2-13 x 1-1/4	1
245-165	3/8-16 x 1	2	245-183*	1/2-13 x 1-1/2	1
245-167	3/8-16 x 1-1/4	1	245-184	1/2-13 x 1-3/4	1
245-170	7/16-14 x 7/8	1	245-185	1/2-13 x 2	1
245-171	7/16-14 x 1	1	245-190	9/16-12 x 1-1/2	1

GRADE B 'CONELOK' LOCKNUTS ÉCROUS À BLOCAGE 'CONELOK'

061
Series

Cadmium plated and waxed

These nuts lock in position when tightened with a wrench.



ORDER BY STOCK NUMBER

Stock No.	Bolt Size	Standard Package	Stock No.	Bolt Size	Standard Package
061-516	5/16-18	100	061-520	7/16-14	50
061-518	3/8-16	100	061-522	1/2-13	50

METRIC BUMPER BAR BOLTS BOULONS DE PARE-CHOC MÉTRIQUE

245
Series

Button Head Blue Zinc Plated



Type 1
Capped



Type 2
Uncapped

Standard Package: 10 Bolts and 10 Metric Pozi-Lok® Nuts.

ORDER BY STOCK NUMBER

Stock No.	Bolt Size	Description	Type	Stock No.	Bolt Size	Description	Type
245-220	M8 x 1.25 x 25 mm	Chrome plated Cap	1	245-223	M8 x 1.25 x 27 mm	Uncapped	2
245-221	M8 x 1.25 x 20 mm	Uncapped	1	245-233	M10 x 1.5 x 33 mm	Stainless Steel Cap	2
245-222	M8 x 1.25 x 27 mm	Stainless Steel Cap	2	245-238	M12 x 1.75 x 40 mm	Stainless Steel Cap	2

MASTER ASSORTMENT

No. 020-611

This assortment contains 68 Bumper Bar Bolts and 68 Self-Locking Nuts in 15 sizes selected according to popularity. Packed in a metal box with moulded plastic compartments. Descriptive lid label shows retail price codes. Will service all popular replacement needs including Metric.

For Metric Pozi-Lok® Nuts see page 36.



020-611











Size: 9-3/4" W x 13-3/4" L x 2" D.

**LICENCE PLATE BOLTS
BOULONS DE PLAQUE**

- 213**
Series
- 230**
Series
- 245**
Series
- 247**
Series

NOW - Service Stations, Garages, Dealers can turn licence plate installations into a profitable sale. Papco[®] Licence Plate Bolts are made of either heavily Electroplated Steel or UV Stabilized Nylon.

ORDER BY STOCK NUMBER Standard Package: as indicated

Stock No.	Description	
213-278	No. 14 x 3/4" Indented Slotted Hex Washer Head Screw. Electro-plated to resist rust. Can be used with 247-840 Nylon Nuts. Standard package contains 100 screws.	
230-616	M6-1.0x20mm Slotted Hex Washer Head Licence Plate Screw 13mm Washer O.D., Hex Size: 10mm, Zinc. Standard package 50 screws.	
245-900	No. 14 x 3/4" Slotted Hex Washer Head Licence Plate Screw. 1/2" Washer O.D., Hex Size: 3/8". Standard package contains 25 screws.	
245-903	For most compact Fords. No. 14 x 5/8" Indented Hex Slotted Oversize Washer Head Screws. Black Zinc to resist rust. Standard package 100 screws. Can be used with 247-840 Nylon Nut.	
245-906	Universal Nylon Licence Plate nut with screws Fits all Ford, G.M. and Chrysler products having a 3/8" Square Hole. Assembly consists of a 14 x 5/8" Screw and No. 14 Square Nylon Nut. Standard package contains 50 assemblies.	
245-910	No. 14 x 5/8" Special Truss Slot Head, Type 'B' Licence Plate Screw. Electroplated to resist rust. Standard package contains 100 screws.	
245-911	M6-1.81x20mm Phillips Hex Washer Head Licence Plate Screw. Standard package contains 25 screws.	
245-912	M6-1.0x16mm Slotted Round Washer Head Licence Plate Screw. Standard package contains 25 screws.	
245-914	No. 14 x 3/4" Slotted Truss Head Licence Plate Screw. 9/16" Head Dia. Standard package contains 100 screws.	
245-915	No. 14 x 3/4" Slotted Hex Washer Head Licence Plate Screws. Standard package 50 Screws.	
247-840	No. 14 Licence Plate Nut. Standard package contains 25 pieces.	

**NYLON LICENCE PLATE BOLTS
BOULONS DE PLAQUE NYLON**

245 Series Papco[®] Nylon Licence Plate Bolts are made of stabilized Nylon. Self-locking - Can't rust - Long Lasting.

No. 245-909

Assembly consists of 1/4-20 x 1/2" Nylon Bolt and a 1/4-20 Self Locking rectangular Nut. Standard package contains 100 assemblies.



No. 245-908

Assembly consists of M6 x 20 Nylon Bolt and an M6 Nylon Hex Nut. Standard package contains 100 assemblies.



For **SUPER-SERVICE ASSORTMENT** No. **020-865** of Licence Plate Bolts please refer to page 11.

For **SUPER-SERVICE ASSORTMENT** No. **020-867** of Nylon Licence Plate Bolts please refer to page 11.

**MOULDING BOLTS
BOULONS DE MOULURE**

246
Series



ORDER BY STOCK NUMBER

Standard Package: 25 Pieces, * 50 Pieces

Stock No.	OEM No.	Application
246-112*	6010093, 1624705	"Universal 'T' Bolt Clip 10-24 x 3/4"
246-116*	3792051	"Chevrolet Front Fender 10-24 x 5/8"
246-120*	10-24 x 1/2" Universal	Universal 'T' Bolt Clip
246-122*	1758099, 6000720, 6010046, 3744999	Universal 'T' Bolt Clip 10-24 x 1/2"
246-124*	3722635, 6013029, 6000705	Universal 'T' Bolt Clip 10-24 x 3/4"
246-210	4759145, 4761842, 4779348	GM Front and Rear Fender and Door Peak - All
246-212	3944866	GM General Purpose
246-214	9645350	GM Door and Door Belt
246-216	1484570	GM General Purpose
246-218	1484569, 6002356	General Purpose Bolt Moulding
246-222	D5AB-60423B06-AA, D5DB-66423B06-CA	Ford Moulding
246-226	D5DB-66423-B06	Ford Bolt Moulding
246-228	D8KB-5420908AA, 4003695	Ford Moulding

'SUPER-SERVICE' ASSORTMENT

No. 020-822

Contains 195 Moulding Bolts.
Complete coverage.
For more detail, see page 10.



**MOULDING CLIPS
PINCES DE MOULURE**

246
Series

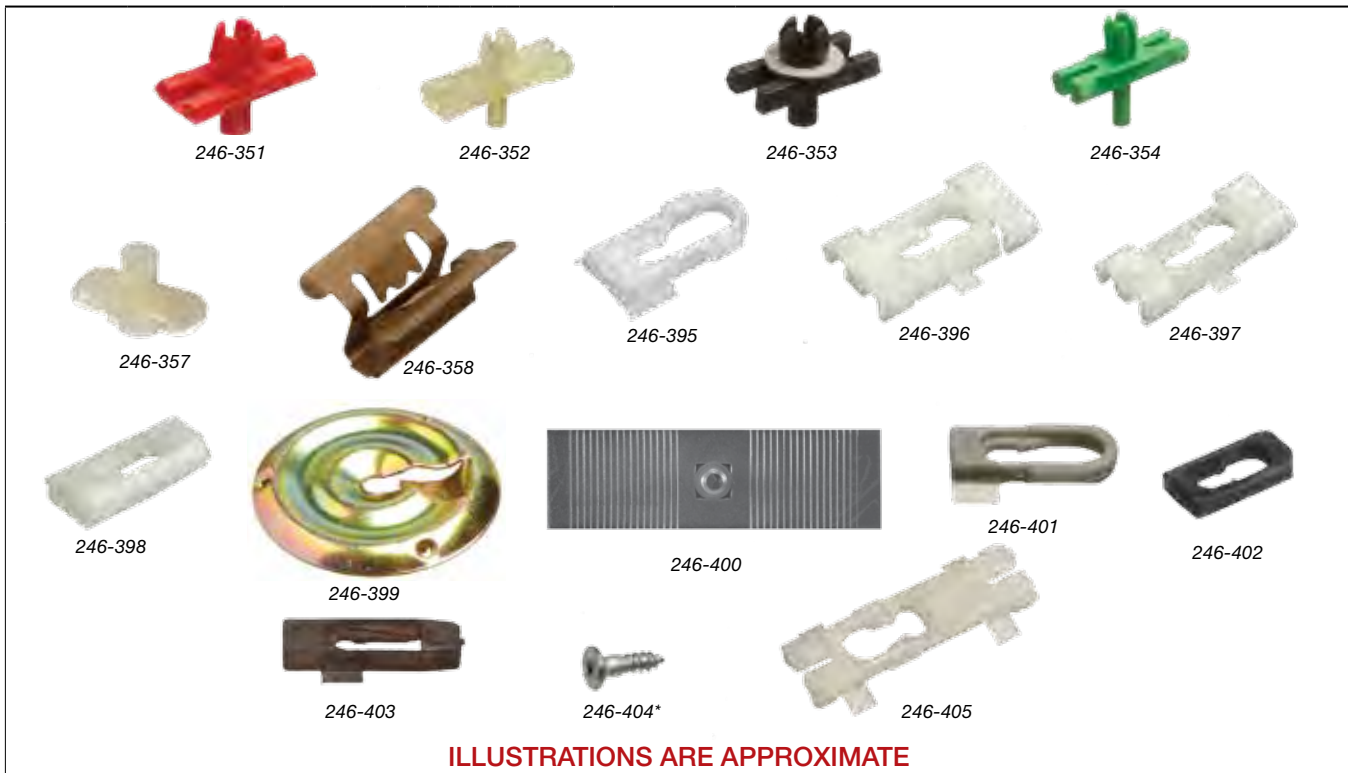

ILLUSTRATIONS ARE APPROXIMATE

ORDER BY STOCK NUMBER

Standard Package: 25 Pieces, * 100 Pieces

Stock No.	OEM No.	Application
246-351	803-853-139C	VW Moulding Clip Red
246-352	825-853-139	Audi Moulding Clip
246-353	5113-1-804-205	BMW Moulding Clip With Sealer
246-354	1202-997	Volvo Moulding Clip Green
246-357	1-247-708	Volvo Side Moulding
246-358	90183-03001	Toyota Front Bumper, Cushion Clip
246-395	8799350	GM Rear End and Quarter Panel Moulding
246-396	20175051	GM Quarter Belt Reveal Moulding
246-397	20199675	GM Quarter Belt Reveal Moulding
246-398	1688094	GM Vinyl Top Moulding
246-399	3986976	GM Rocker Panel Moulding - Metal
246-400	10-24 x 3/4 Universal	Scored Type Moulding Bolt fits up to 2-1/2" wide
246-401	9838109	GM Body Side Moulding
246-402	4492962	GM Body Side and Wheel Opening Moulding
246-403	D1MY 65402488	Ford Roof Cover and Body Side Mouldings
246-404*	4-24 x 3/8 Special Phillips Flat Head	Screw (replaces Welded Studs)
246-405	6003133	Chrysler Door and Fender

**WINDOW REGULATOR RIVETS
RIVET RÉGULATEUR DE FENÊTRE**

Aluminum Body/Steel Mandrel



ORDER BY STOCK NUMBER

Standard Package: 25 Pieces

Stock No.	OEM No.	Dia.	Flange	Grip Range	Application
246-600	9436175, 385189-S100, 6031115	1/4	1/2	1/32-9/64	GM, Ford, Chry, Window Regulator
246-605	20184399, 389268-S100	1/4	1/2	11/16-3/4	GM, Ford, Window Regulator
246-610	385323-S100, 6031091	1/4	1/2	33/64"-19/32"	Ford, Chrysler, GM Window Regulator
246-612	388047-S100	1/4	1/2	5/64"-7/64"	Ford Door Handle Assembly, GM Heat Shield Attach
246-614	388442-S100	1/4	3/4	1/8"-1/4"	Steel Mandrel Bumper Assembly
246-616	388047-S100	1/4	1/2	3/32"-1/8"	Steel Mandrel Bumper Assembly

**GLASS SHOP FASTENERS
ATTACHES A PARE-BRISE**

**246
Series**

ORDER BY STOCK NUMBER

Standard Package: 25 Pieces, *10 Pieces



ILLUSTRATIONS ARE APPROXIMATE

Stock No.	OEM No.	Application
246-356	1-255-553	Volvo Windshield Moulding White
246-359	75546-32010, 75548-32010	Toyota Windshield Moulding with Adhesive Pad
246-360*	90674-692-0030	Honda Windshield Moulding with Adhesive Pad
246-409	9895598	GM Windshield Reveal Moulding
246-410	1654047 (Nylon)	GM Windshield and Rear Window Reveal Moulding
246-411	8717859, 9854717	GM Rear Window Reveal Moulding
246-412	C8AZ-63642413-A, D1AZ-6542413-B	Ford Rear Window and Windshield Moulding
246-413	6003049, 6003752	Chrysler Windshield and Rear Window Reveal Moulding
246-415	E3SB-6342413-AB	Ford Windshield and Backlight Moulding
246-416	6003878 (Nylon/Metal)	Chrysler Windshield Backlight Moulding
246-417	9662950, 9606232, 20603072	GM Windshield and Rear Window Reveal Moulding
246-418	9731301 (Nylon), AMC #4005540	GM Windshield to Panel Lower Side
246-419	20169887 (Nylon)	GM Windshield Reveal Moulding
246-420	9808241	GM Windshield and Rear Window Reveal Moulding
246-425	4234830, 12337868	GM Door Lock Rod Clip
246-436	6003752	Chrysler Windshield and Backlight Reveal Moulding

**TRIM FASTENERS
ATTACHES FINITION**

**247
Series**

Christmas Tree Clips

The flexible ribs of these nylon fasteners deflect as the clip is pushed into a panel hole and hold securely anywhere along their ribbed shank. The Cut-Out-Type can be twisted into a small panel hole for retention. Used on inner door panels to hold covering or trim.

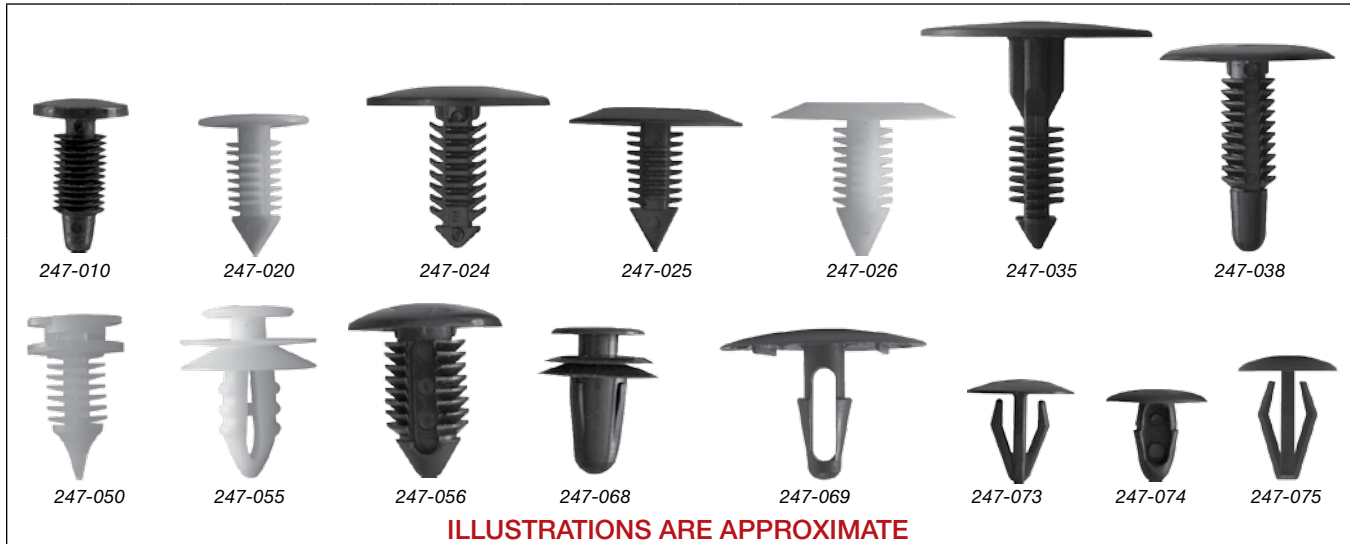

ORDER BY STOCK NUMBER

Standard Package: 25 Pieces

Stock No.	OEM No.	Application	Stock No.	OEM No.	Application
247-010	411700	GM - Trim Panel Retainer	247-055	387477-S	Ford - Interior Trim Panel
247-020	6003587, 25514221	GM, Chrysler - Roof Headliner	247-056	22512276	GM - Panel Retainer
247-024	389443-S	Ford - Fascia To Bumper	247-068	95005064, 67771-01010	GM, Toyota - Door Trim Panel
247-025	6003349, 6032363, 385661-S, N989022	Ford, Chrysler - Trim Panel	247-069	90467-09008	Toyota - Retaining Clip
247-026	6003423, 2048248	GM, Chrysler - Interior Trim Panel	247-073	38529-689A-6300	Honda - Retaining Clip
247-035	N-800387-S	Ford - Dashboard	247-074	90467-06161-01	Toyota - Retaining Clip
247-038	388930-S	Ford - Trim Panel Retainer	247-075	76906-T3000	Nissan - Retaining Clip
247-050	6013122, 20298365	GM, Chrysler - Trim Panel Ret.			

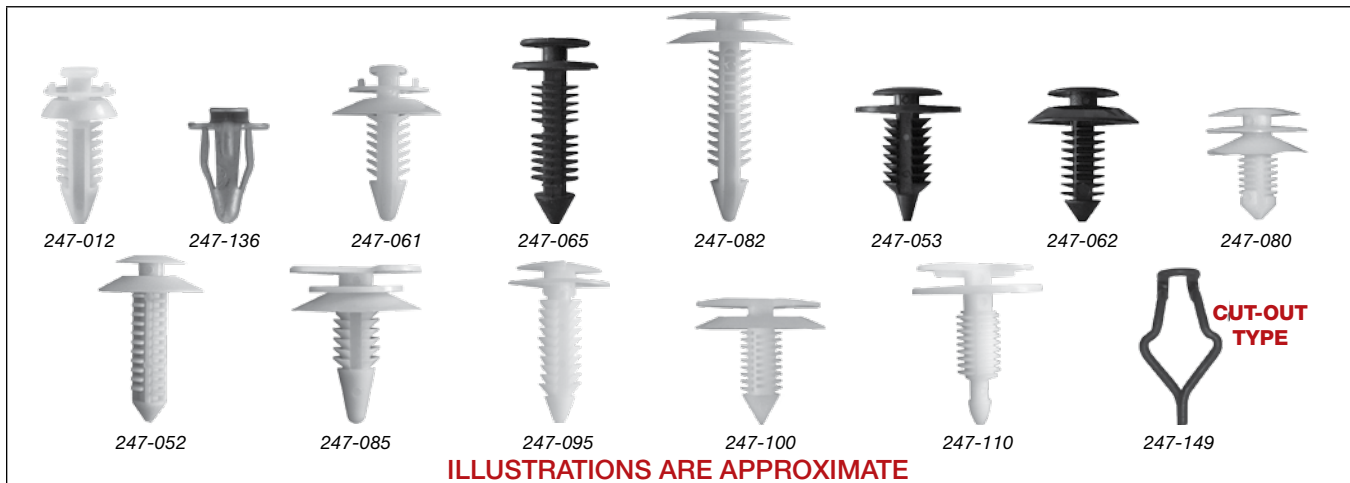

ORDER BY STOCK NUMBER

Standard Package: 25 Pieces

Stock No.	OEM No.	Application	Stock No.	OEM No.	Application
247-012	15545202, 15612948, 15607165, 15953247	GM - Door Trim Panel	247-082	10126901	GM - Trim Panel
247-052	8934-202-599, 10143422, N805612-S100	Ford, GM, Jeep Eagle Door Trim Panel	247-085	3065575	GM - Door Trim Panel
247-053	N805155-S	Ford - Door Trim Panel	247-095	363137	Chev. Truck, GMC - Trim Panel
247-061	10073833, 15600382, 20421800	GM - Door Trim Panel	247-100	9685057, N98905101, 4005470, 6003349	GM, Chrysler, VW-Door Trim Panel
247-062	N801925-S	Ford - Door Trim Panel	247-110	387496-S	Ford - Trim Panel Retainer
247-065	387182-S	Ford - Seat Back	247-136	4114785	Chrysler - Trim Panel
247-080	2064891, 9818648, 9883583	GM - Door Trim Panel & Headliner	247-149	383033-S101, 358470, 1900654	Ford - Door Trim Panel

**PLASTIC SHIELD RETAINERS
RETENUES DE PROTÉGER PLASTIQUE**

247
Series

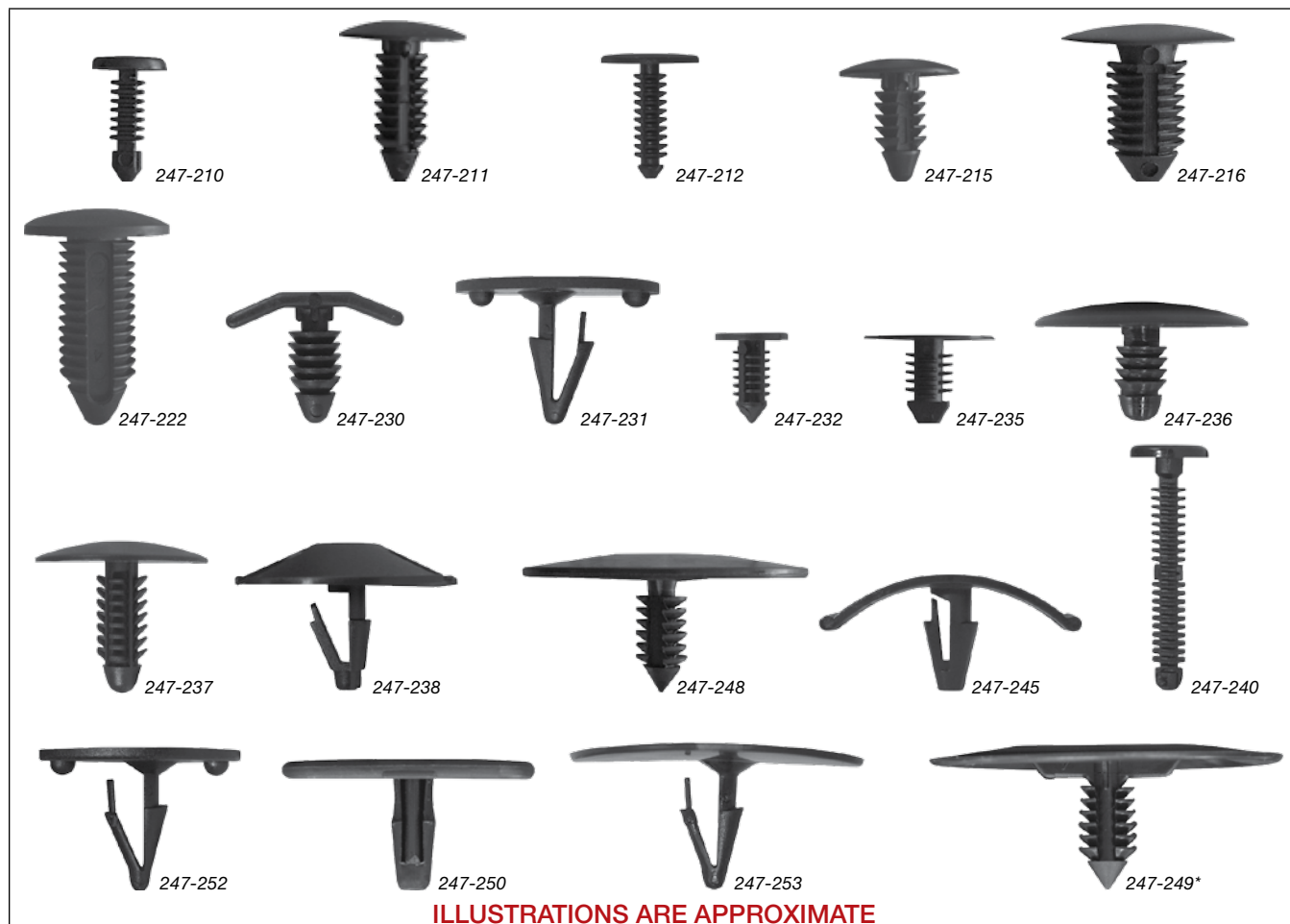

ILLUSTRATIONS ARE APPROXIMATE

ORDER BY STOCK NUMBER

Standard Package: 25 Pieces

Stock No.	OEM No.	Application	Stock No.	OEM No.	Application
247-210	25016383	GM Dash Panel	247-236	2998430	Chrysler, Radiator Grille
247-211	6030441, 388577S, 1595864, 1605396, 705589-S300	GM, Ford, Chrysler, Radiator	247-237	6501067	Chrysler Fascia
247-212	20514862	GM Screen Shroud	247-238	4341060	Chrysler Hood Insulated
247-215	4004569, 3691590, 6031321, 389358, 332364, 14093311, 20732399	GM, Ford, Chrysler Fender	247-240	N-800505-S	Ford Radiator Attaching
247-216	1619321	GM Radiator Apron	247-245	6003351, 385330-S, D30Z-16776-A	Ford Grille, Chrysler Hood
247-222	N804379S, 1631564	GM, Ford Bumper	247-248	20064875	GM Hood Insulation
247-230	384051-S, 480534	GM, Ford, Cowl Insulation	247-249	3977775, 3078511	GM Hood Insulation
247-231	385595-S, 386553-S	Ford Hood Insulation	247-250	389809	GM Hood Insulation
247-232	N803170-S	Ford Fascia	247-252	386553-S	Ford Hood Insulation
247-235	387258-S, 20032850, 3861577	GM, Ford, Chrysler Mud Shield	247-253	388908-S	Ford Hood Insulation

TRIM PAD RELEASE TOOL

No. 247-299

Made of heat-treated, high carbon steel with bevelled front edges for easy insertion - plus a machined gripping slot for positive contact. Designed to remove plastic trim pad fasteners without damaging the fastener or backboard. Works well on metal trim pad fasteners. Individually carded.



247-299

**WEATHERSTRIP FASTENERS
ATTACHES POUR BANDE MÉTÉOROLOGIQUE**

**247
Series**

ORDER BY STOCK NUMBER

Standard Package: 25 Pieces



ILLUSTRATIONS ARE APPROXIMATE

Stock No.	OEM No.	Application	Stock No.	OEM No.	Application
247-077	90664-671-0030	Honda Weatherstrip Fits 5 mm Hole	247-160	2964547	Chrysler Weatherstrip
247-150	8731909	GM Door Weatherstrip	247-165	C5AB-6220586-A	Ford Door Weatherstrip
247-155	4876498	GM Door and Body Weatherstrip			

**ANCHOR NUTS AND CLIPS
ÉCROUS ET PINCES D'ANCRAGE**

**247
Series**

ORDER BY STOCK NUMBER

Standard Package: 25 Pieces *50 Pieces **10 Pieces

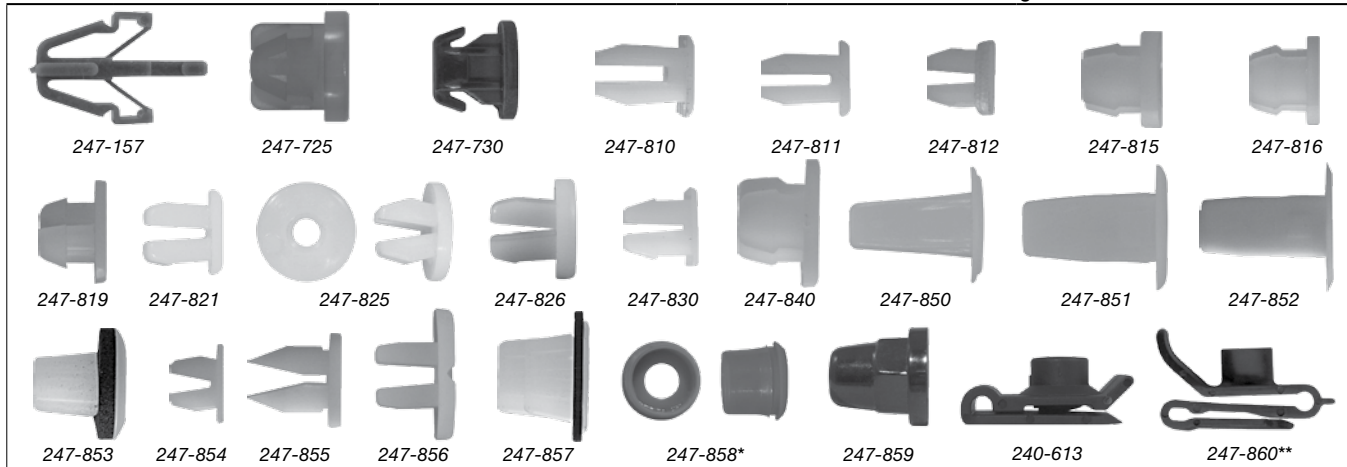

Stock No.	OEM No.	Application	Stock No.	OEM No.	Application
240-613	53879-22010	Toyota "U" Nut No. 14 Screw	247-851	90661-SC7-0030	Honda No. 8 Screw Grommet
247-157	-	Plymouth Laser Grille Clip		H001-50-841	Mazda No. 8 Screw Grommet
	-	Ford Escort Grille Clip		MS-480012	Mitsubishi No. 8 Screw Grommet
	-	Honda Grille Clip		01651-00481, 74798-S9000	Nissan No. 8 Screw Grommet
	8942180270	Isuzu Grille Clip	247-852	MB-098145	Mitsubishi No. 10 Screw Grommet
	-	Mitsubishi & Plymouth Laser Grille Clip		01281-00023	Nissan No. 10 Screw Grommet
247-725	6031234	Chrysler Radiator Grille Nut No. 8 Screw		90189-06001	Toyota No. 10 Screw Grommet
247-730	N800503-S	Ford Grille Attachment Nut No. 6 Screw	247-853	90189-04066	Toyota No. 6 Screw Grommet
247-810	379830-S	Ford Headlight Door No.8 or 10 Screw		90662-693-0030	Honda No. 6 Screw Grommet
247-811	1254815	GM General Purpose No. 6 Screw	247-854	90655-SA0-0030	Honda No. 6 Screw Grommet
247-812	9669486	GM Side Marker No. 8 Screw	247-855	90189-05013	Toyota No. 10 Screw Grommet
247-815	3893980 (Black)	GM Grille to Front End No. 8 Screw		MS-480002	Mitsubishi No. 10 Screw Grommet
247-816	3919773	GM Headlamp Bezel No. 8 Screw	247-856	90662-671-0030	Honda No. 10 Screw Grommet
247-819	14013246	GM No. 8 Screw		9991-00-503	Mazda No. 10 Screw Natural Nylon
247-821	8934-201-263	Chrysler Radiator Grille No. 8 Screw		68425-H5000,	Nissan No. 10 Screw Grommet
247-825	2524525	Chrysler No. 8 or 10 Screw		62698-V7000	
247-826	1355003	GM Headlight Door No. 6 or 8 Screw	247-857	90668-688-0030	Honda No.6 Screw Grommet w/sealer
247-830	380382	GM Headlight Bezel No. 6 or 8 Screw	247-858*	000-988-15-81	Mercedes Benz Moulding Insert Red
247-840	3907444, 4755299	Licence Plate Nut No. 14 Screw	247-859	4133-5-480-120	BMW Plastic Nut 4mm Thread
247-850	90672-671-8110M1	Honda No. 6 Screw Grommet	247-860**	94841226	GM "U" Nut No. 10 Screw
	90189-04013	Toyota No. 6 Screw Grommet		53879-14020,	Toyota "U" Nut No. 10 Screw
				53879-22030	
				53879-14010-A	

ANCHOR NUTS UTILITY ASSORTMENT

No. 020-358

Contains 150 Nuts of 247-810, to 247-840.
Complete coverage.

020-358



SPECIALTY RETAINERS ASSORTMENT

No. 020-450

Contains 190 pieces of the 20 most popular SKUs in specialty retainers, constructed from high-quality materials. Push-in and Screw-in types. Various diameters and lengths to fit various applications. Matching visual reference guide on the inside cover to identify parts. All items available for reorder.

020-450



ANCHOR GROMMETS AND NUTS MASTER ASSORTMENT

No. 020-678

Contains 295 Anchor Grommets and Nuts.
Packed in a metal container with high-strength plastic compartments.

020-678



TRIM FASTENERS MASTER ASSORTMENT

No. 020-679

Contains 150 Fasteners – General Motors.
For more details, see page 8.

020-679



TRIM FASTENERS MASTER ASSORTMENT

No. 020-680

Contains 150 Fasteners – Chrysler and Ford.
For more details, see page 8.

020-680



TRIM FASTENERS 'SUPER-SERVICE' ASSORTMENT

No. 020-813

Contains 300 Trim and Weather-strip Fasteners,
plus shield retainers.
For more details, see page 10.

ANCHOR GROMMETS AND NUTS 'SUPER-SERVICE' ASSORTMENT

No. 020-814

Contains 465 Anchor Grommets and Nuts - 32 items.
Large size, rigid metal box with high-strength plastic compartments. Size: 12" W x 18" L x 3" D.
For more details see page 10.

020-814



**SCREW-IN RETAINERS
ATTACHE DE SOUTIEN AVEC VIS**

**247
Series**

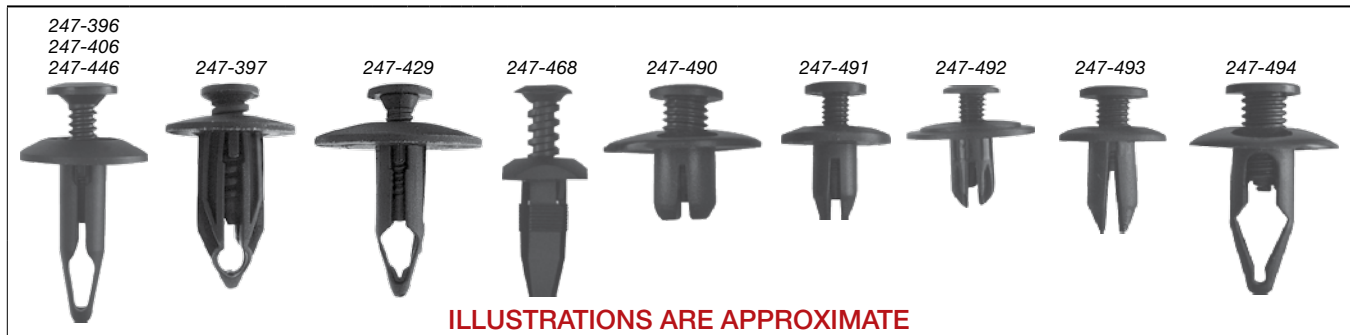

ILLUSTRATIONS ARE APPROXIMATE

ORDER BY STOCK NUMBER			Standard Package: 25 pieces		
Stock No.	OEM No.	Application	Stock No.	OEM No.	Application
247-396	N803946-S	Ford Push-Type Exterior Retainer	247-468	N803494-S	Ford Aerostar Fascia, Trim and Grille
247-406	6502871	Chrysler	247-490	1579091	GM Blazer and Jimmy Door handle Bezel
247-397	15672330	GM Push-Type Exterior Retainer	247-490	90675-SB3-003	Honda Screw Retainer
247-406	15956470	GM	247-491	FB01-56-964	Mazda
247-406	N804570-S	Ford Trim Retainer	247-491	63876-95596	Nissan
247-429	20664092	GM Exterior Body	247-491	90684-SA5-0030	Honda Screw Retainer
247-429	N804837-S	Ford Push-Type Exterior Retainer	247-492	10998-30880	Nissan
247-446	N808147-S	Ford Push-Type Exterior Retainer	247-492	90668-SB0-0030	Honda Screw Retainer
247-446	10139822	GM	247-493	90467-06017-20	Toyota Screw Retainer
247-446	25680782	GM	247-494	63844-01A00	Nissan Screw Retainer

PLASTIC-RIVETS

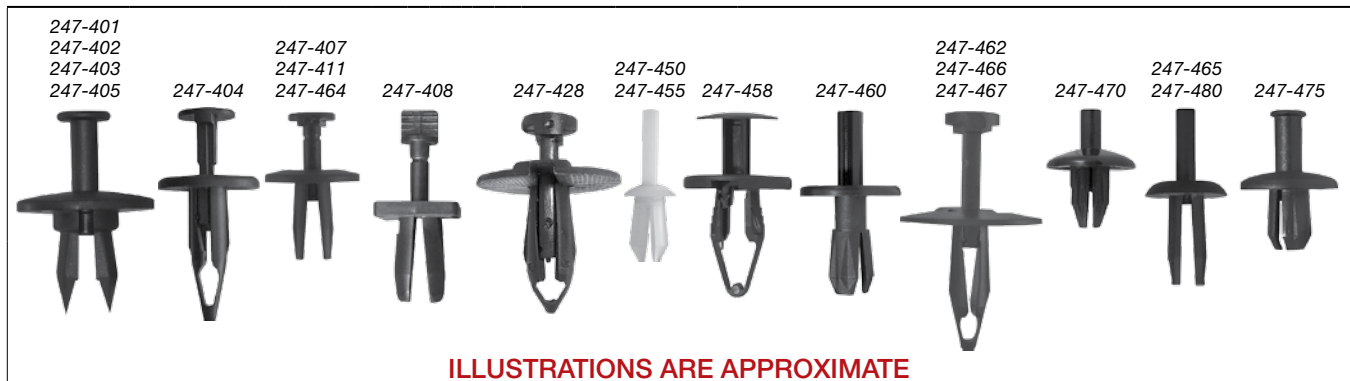

ILLUSTRATIONS ARE APPROXIMATE

ORDER BY STOCK NUMBER			Standard Package: 25 pieces, *15 pieces		
Stock No.	OEM No.	Application	Stock No.	OEM No.	Application
247-401*	5973400	GM Fascia	247-460	387944-S	Ford Grille to Metal Stamping
247-402	5973823	GM Fascia (Blue)	247-462	N802781-S	Ford Splash Shield and Fascia
247-403	5973996	GM Fascia (Brown)	247-464	14093088	GM
247-404	20590899	GM Exterior Body	247-464	N805231-S	Ford Grille Opening Reinforcement
247-405	14045480	GM Fascia	247-465	387843-S	Ford Fender Shield
247-407	14019206	GM Fender Line	247-466	N803362-S	Ford Body
247-408	14032200	GM Grille Attachment	247-466	20510029	GM
247-411	14019226	GM Rad Overflow and	247-467	6501590	Chrysler Splash Shield and Fascia
247-411	14071289	Windshield washer Reservoir	247-467	N803421-S	Ford
247-428	20547865	GM Exterior Body Retainer	247-470	383142-S	Ford Grille to Headlamp Bracket
247-450	14005089	GM A/C Vents General Purpose	247-475	6031383	Chrysler Grille
247-455	10017619	GM Front Bumper Grille bar	247-480	6031390	Chrysler Plastic Inner Fender
247-458	W712665-S300	Ford Exterior Body Retainer			
247-458	11589295	GM			

**UTILITY SCISSORS
CISEAUX FONCTIONNELS**

249
Series

No. 249-120

Professional quality features stainless steel blades with long-lasting ground edges and high-impact, man-size A.B.S. plastic handles. Individually packaged on 'try-me' blister card.



249-120

**UTILITY SHEARS
CISAILLES FONCTIONNELS**

No. 249-130

Professional quality, stainless steel blades with long-lasting edges. High-impact handles with safety lock. For wire, thin sheet metal, shim stock, vinyl, fiberglass and more. Individually carded.



249-130

**UTILITY SCRAPERS
GRATTOIRS FONCTIONNELS**

Papco[®] Utility Scrapers are ideal for trimming, cutting, splicing, scraping paint or stickers. Choose from the retractable, pocket size or standard, angled head for hard-to-reach places - both use either steel or plastic razor blades.

No. 249-124 Angled Head for hard-to-reach places

No. 249-125 Retractable, pocket size

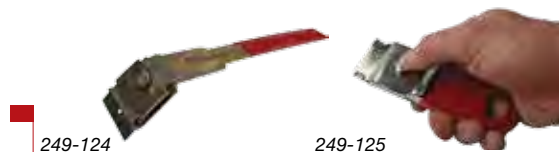

249-124

249-125

**REPLACEMENT BLADES
LAMES DE RECHANGE**

Steel Razor Blades

No. 249-126

Single edge, industrial duty steel replacement blades for No. 249-124 and 249-125 utility scrapers. Skin packed card contains 10 blades in a recloseable box.



249-126

Plastic Razor Blades

No. 249-127

For cleaning sun film or laminated glass without cutting or nicking. Fits both Papco[®] Utility Scrapers. Skin packed card contains 100 blades in a recloseable box.



249-127

**TOOLS
OUTILS**

246
Series

Windshield Moulding Release Tool

No. 246-500

Windshield Moulding Release Tool for removing all windshield mouldings. Features angled shaft and bevelled front edges for easy entry.



246-500

Window Handle Removing Tool

No. 246-895

Window Handle Removing Tool for removing inside door and window handles.



246-895

**PLUG BUTTONS
BOUCHONS**







**314
Series**

Black Vinyl or Metal

Papco[®] Plug Buttons are used for plugging unsightly body holes after removing accessories, rust-proofing or body repair.

ORDER BY STOCK NUMBER

Standard Package: 100 Pieces

Stock No.	Description	
Black Vinyl		
314-314	3/8 Diameter, Flush Sheet Metal Plug Head Dia. 3/4"	
314-316	1/2 Diameter, Flush Sheet Metal Plug Head Dia. 7/8"	
Black Vinyl		
314-322	1/2 Diameter, Plastic Plug Button Head Dia. 7/8"	
314-326	3/4 Diameter, Plastic Plug Button Head Dia. 1-5/32"	
314-328	7/8 Diameter, Plastic Plug Button Head Dia. 1-7/32"	
314-330	1" Diameter, Plastic Plug Button Head Dia. 1-11/32"	

**CASTER AND CAMBER SHIMS
CALES POUR CHASSE DIRECTION**

**250
Series**

Papco[®] Shims are used to adjust caster on knee-action and ball-joint suspensions. All Papco[®] shims are plated to resist rust and stamped with thickness or degree.

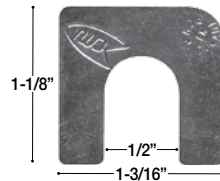

General Motors 1971-up		
Stock No.	Thickness	Slot
250-082	1/6"	1/2"
250-083	1/8"	1/2"

1-3/16"W x 1-1/8" H.

**BODY SHIMS
CALES DE CARROSSERIE**

**250
Series**

- Used for alignment of Hoods, Fenders, Cowls and Starter Motors
- Plated Steel, Standard Package Contains 25 Shims

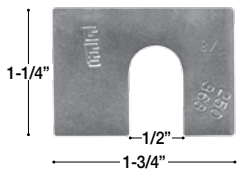

Body Shim	
Stock No.	Thickness
250-362	1/16"
250-363	1/8"

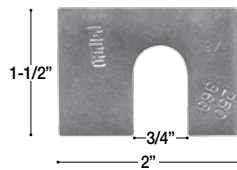

Body Shim	
Stock No.	Thickness
250-368	1/8"

Ford

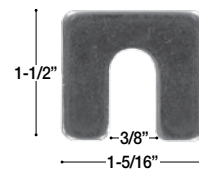

Hood Shim	
Stock No.	Thickness
250-371	1/16"
250-372	1/8"

Chevrolet

DOOR HINGE PINS AND BUSHINGS GOUPILLES ET BAGUES DE CHARNIÈRE – PORTES

Papco® Door Hinge Pins and Bushings are replacements for original equipment hardware that has worn, been broken or damaged - causing misalignment, sagging or sticking.

ILLUSTRATIONS ARE APPROXIMATE



250-545 Std. Pkg. 25 pcs.
O.D. 1/2", I.D. 11/32"
 • GM C-K Models 1988-on
 Height: 23/64", Flange O.D. 43/64"
 Splined O.D. Side Door Upper Hinge
Door Hinge Bushing
 #12338074, 15691493, 15964971, 16632193
 CL Part No: 910-1615, Pieces: 2



250-546 Std. Pkg. 25 pcs.
O.D. 17/32", I.D. 25/64"
 • GM C-K Models 1988-on
 Height: 23/64", Flange O.D. 11/16"
 Splined O.D. Side Door Lower Hinge
Door Hinge Bushing
 #15562609, 15964972, 16632192
 CL Part No: 910-1616, Pieces: 2



250-549 Std. Pkg. 25 pcs.
O.D. 1/2", I.D. 11/32"
 • Buick 1976-on • Cadillac 1980-on
 • Chevrolet All 1976-on, Corvette 1982-73
 • Olds Exc. Starfire: 1980-on
 • Pontiac Exc. Astre & Sunbird 1980-on
 Height: 3/8", Flange O.D. 19/32"
Door Hinge Bushing
 #9716926, 20345137
 CL Part No: 910-1600, Pieces: 3



250-550 Std. Pkg. 25 pcs.
O.D. 27/64", I.D. 11/32"
 • Buick (Exc. Skyhawk) 1967-on • Cadillac 1946-on
 • Chevrolet (Exc. Monza & Vega) 1962-on, Corvette 1956-on
 • GM C&K Truck 1993-79 • Olds (Exc. Starfire) 1949-on
 • Pontiac (Exc. Astre & Sunbird) 1932-on
 Height: 19/64", Flange O.D. 19/32"
Door Hinge Bushing
 GM #9721917, FORD #D1AZ-6522841A
 CL Part No: 910-1601, Pieces: 2



250-551 Std. Pkg. 25 pcs.
O.D. 31/64", I.D. 11/32"
 • Ford 1973-on
 Head Dia. 20mm, Stem Length: 9mm
 Flange O.D. 19/32
Door Hinge Bushing
 #D90Z-6522841A
 CL Part No: 910-1602, Pieces: 2



250-552 Std. Pkg. 25 pcs.
O.D. 5/16", I.D. 17/64"
 • Dodge & Chrysler 1970-on
 Length: 23/64", Flange O.D. 33/64"
Door Hinge Bushing
 #4033711
 CL Part No: 910-1603, Pieces: 3

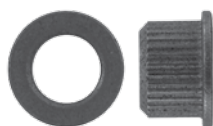

250-553 Std. Pkg. 25 pcs.
O.D. 31/64", I.D. 11/32"
 • GM (Including Pick-Ups & Vans) 1968-on
 Length: 23/64", Flange O.D. 19/32"
 Splined O.D.
Door Hinge Bushing
 #20429500
 CL Part No: 910-1610, Pieces: 2



250-559
Pin Dia. 11/32", Length: 4-1/16"
 • Buick, Cadillac, Chevrolet, Oldsmobile, Pontiac 1992-1973
 Overall Head Dia. 9/16"
Door Hinge Pin
 #6271989, 20046147
 CL Part No: 910-1620, Pieces: 1



250-560
Pin Dia. 11/32", Length: 4"
 • Buick, Chevrolet, Oldsmobile, Pontiac 1995-1978
 Overall Head Dia. 7/16"
Door Hinge Pin
 #20043351
 CL Part No: 910-1625, Pieces: 1

**DOOR HINGE PINS AND BUSHINGS
GOUPILLES ET BAGUES DE CHARNIÈRE – PORTES**

ILLUSTRATIONS ARE APPROXIMATE



250-561

Dia. 11/32", Length: 5-1/4"

• **GM C & K Trucks 1988-2000**
Shoulder O.D. 3/8", Head O.D. 9/16"
Stainless Steel Door Hinge Pin
#15591860; 15691595; 15967691; 88891731
CL Part No: 910-1630, Pieces: 1



250-562

Pin Dia. 17/64", Length: 2-3/4"

• **Dodge & Plymouth** vans, Ramcharger & Trailduster 1970-on
Head O. D. 9/16"
Door Hinge Pin
Cargo doors, lift gates, rear doors and fold-up rear seat floor hinges
#6028993, 6032975



250-563

Dia. 9/16", Length: 5-1/2"

• **GM C & K Trucks 1988-2000**
Knurl Dia. 19/32", Roller Overall Dia. 3/4",
Door Roller Pin Assembly
Roller Groove Dia. 5/8"
Not Available through O.E.M.



250-564

Dia. 25/64", Length: 5-1/16"

• **GM S & T Trucks 1994-on**
Door Roller Pin Assembly
Roller Overall Dia. 3/4",
Roller Groove Dia. 5/8"
#15672183



250-566

Dia. 11/32", Length: 3-1/2"

• **Ranger F150, F250, F350 1998-80**
Knurl Dia. .358", Overall Head Dia. 9/16"
Door Hinge Pin



250-567

Door Hinge Repair Kit

• **Chevrolet** Suburban 1500/2500 & Tahoe 2006-2000 • **GMC** Yukon 2006-2001
• **Cadillac** Escalade 2006-2000
• **Chevrolet** Silverado & **GMC** Sierra 1500/2500, HD/3500, HD 2007-1999
Door Hinge Repair Kit
#89025539

BLIND RIVETS RIVETS OBTURATEURS

239
Series



Fasten joints without access to reverse side. Insert rivets - the retracting jaws in the setting tool pull the mandrel head into the rivet body on the reverse side until the mandrel breaks. The high clinch action pulls the parts together for a tight, vibration-proof fastening.

Standard Package: 1/8" and 5/32" Dia. 500 rivets; 3/16" Dia. 250 rivets; Stainless Steel 100 rivets. Most popular sizes available in 50 Rivets per convenient hang-up boxes. *25 per hang-up box.

Rivet Diameter		Drill		How to measure rivets:	
Inch	Metric	Number	Size		
3/32	2.4 mm	No. 41	.096 - .100		
1/8	3.2 mm	No. 30	.129 - .133		
5/32	4.0 mm	No. 20	.160 - .164		
3/16	4.8 mm	No. 11	.192 - .196		

ORDER BY STOCK NUMBER

Stock No.	Other No.	Hang-up Box No.	Rivet Dia.	Grip Range	Head Type	Rivet Length	
Aluminum Rivet - Aluminum Mandrel							
239-011	AA42D	239-611	1/8 (.125)	1/16 - 1/8	Domed Head	.232	
239-014	AA43D	239-614		1/8 - 3/16	Domed Head	.294	
239-017	AA44D	239-617		3/16 - 1/4	Domed Head	.357	
239-018	AA44LF	-		3/16 - 1/4	Large Flange	.357	
239-023	AA46D	-		5/16 - 3/8	Domed Head	.481	
239-026	AA48D	-		3/8 - 1/2	Domed Head	.625	
239-038	AA56D	-		1/4 - 3/8	Domed Head	.504	
239-047	AA62D	239-647*		1/16 - 1/8	Domed Head	.277	
239-053	AA64D	239-653*		1/8 - 1/4	Domed Head	.402	
239-056	AA66D	-		1/4 - 3/8	Domed Head	.527	
239-057	AA66LF	-		1/4 - 3/8	Large Flange	.527	
239-059	AA68D	-		3/8 - 1/2	Domed Head	.652	
239-060	AA68LF	-		3/8 - 1/2	Large Flange	.652	
Aluminum Rivet - Steel Mandrel							
239-111	AS42D	239-711	1/8 (.125)	1/16 - 1/8	Domed Head	.232	
239-114	AS43D	239-714		1/8 - 3/16	Domed Head	.294	
239-117	AS44D	239-717		3/16 - 1/4	Domed Head	.357	
239-150	AS62D	239-750*		1/16 - 1/8	Domed Head	.277	
239-153	AS64D	239-753*		1/8 - 1/4	Domed Head	.402	
239-156	AS66D	-		1/4 - 3/8	Domed Head	.527	
239-159	AS68D	-		3/8 - 1/2	Domed Head	.652	
239-160	AS68LF	-		3/8 - 1/2	Large Flange	.652	
Steel Rivet - Steel Mandrel							
239-210	SS42C	239-810		1/8 (.125)	1/16 - 1/8	Countersunk	.276
239-211	SS42D	239-811			1/16 - 1/8	Domed Head	.232
239-213	SS43C	239-813			1/8 - 3/16	Countersunk	.316
239-214	SS43D	239-814			1/8 - 3/16	Domed Head	.294
239-216	SS44C	239-816	3/16 - 1/4		Countersunk	.362	
239-217	SS44D	239-817	3/16 - 1/4		Domed Head	.357	
239-218	SS44LF	-	3/16 - 1/4		Large Flange	.357	
239-223	SS46D	-	5/16 - 3/8		Domed Head	.481	
239-226	SS48D	-	3/8 - 1/2		Domed Head	.625	
239-229	SS52D	-	1/16 - 1/8		Domed Head	.254	
239-235	SS54D	-	3/16 - 1/4		Domed Head	.397	
239-238	SS56D	-	1/4 - 3/8		Domed Head	.504	
239-250	SS62D	239-850*	1/16 - 1/8		Domed Head	.277	
239-253	SS64D	239-853*	1/8 - 1/4	Domed Head	.402		
239-256	SS66D	-	1/4 - 3/8	Domed Head	.527		
239-257	SS66LF	-	1/4 - 3/8	Large Flange	.527		
239-259	SS68D	-	3/8 - 1/2	Domed Head	.652		
239-260	SS68LF	-	3/8 - 1/2	Large Flange	.652		
239-262	SS610D	-	1/2 - 5/8	Domed Head	.777		
239-263	SS610LF	-	1/2 - 5/8	Large Flange	.777		
239-265	SS612D	-	5/8 - 3/4	Domed Head	.902		
239-266	SS612LF	-	5/8 - 3/4	Large Flange	.902		
Stainless Rivet - Steel Mandrel							
5195-111	STS42D	-	1/8 (.125)	1/16 - 1/8	Domed Head	.232	
5195-114	STS43D	-		1/8 - 3/16	Domed Head	.294	
5195-117	STS44D	-		3/16 - 1/4	Domed Head	.357	
5195-123	STS46D	-		5/16 - 3/8	Domed Head	.481	
5195-126	STS48D	-		3/8 - 1/2	Domed Head	.625	
5195-150	STS62D	-		1/16 - 1/8	Domed Head	.277	
5195-153	STS64D	-		1/8 - 1/4	Domed Head	.402	
5195-156	STS66D	-		1/4 - 3/8	Domed Head	.527	
5195-159	STS68D	-		3/8 - 1/2	Domed Head	.652	
Stainless Rivet - Stainless Mandrel							
5195-211	STST42D	-		1/8 (.125)	1/16 - 1/8	Domed Head	.232
5195-214	STST43D	-			1/8 - 3/16	Domed Head	.294
5195-217	STST44D	-			3/16 - 1/4	Domed Head	.357
5195-223	STST46D	-	5/16 - 3/8		Domed Head	.481	
5195-226	STST48D	-	3/8 - 1/2		Domed Head	.625	
5195-250	STST62D	-	1/16 - 1/8		Domed Head	.277	
5195-253	STST64D	-	1/8 - 1/4		Domed Head	.402	
5195-256	STST66D	-	1/4 - 3/8		Domed Head	.527	
5195-259	STST68D	-	3/8 - 1/2		Domed Head	.652	

**HAND RIVETERS
RIVETEUSE MANUELLE**

239
Series

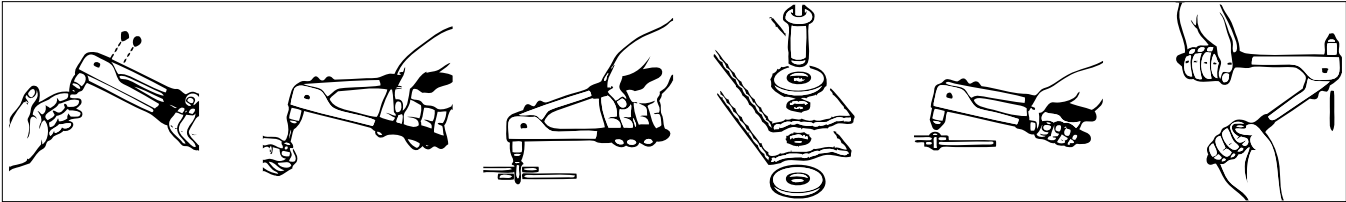

1. Drill a hole of the recommended size in each of the parts to be riveted and select correct nose-piece.
2. Fully open handles. Insert rivet until head touches nose-piece.
3. Insert rivet in the hole.
4. For soft materials or oversize holes use back-up plates to eliminate rivet pull-through.
5. Squeeze handles together. If mandrel does not break, open handles, push rivet head back to nose-piece and repeat until mandrel breaks.
6. Hold riveter with nose-piece up. Fully open handles and snapped off stem will fall out.

MEDIUM DUTY BLIND RIVETER

No. 239-500

An economical tool for medium duty. Vinyl grips on stamped long handles for extra leverage with milled steel nose. Sets 3/32", 1/8", 5/32" and 3/16" Dia. aluminum rivets. Individually packaged.



239-500

PROFESSIONAL SERVICE BLIND RIVETER

No. 239-501

Sturdy, fast acting tool. Will set 3/32", 1/8", 5/32" and 3/16" Dia. rivets. Capacity 3/16" aluminum. Moulded contour hand grips and long forged handles for extra leverage. Complete with four nose-pieces. Heavy Duty Individually packaged.



239-501

BLIND RIVET MASTER ASSORTMENT

No. 020-667

Contains 1200 pieces - 10 popular sizes of Aluminum and Steel Domed Head Rivets and 3 sizes of Back-up Plates. Packed in a sturdy metal container with handy moulded compartments and an actual size illustrated grease-resistant lid label. Size: 9-3/4" W x 13-3/4" L x 2" D.



020-667

**MULTI-GRIP BLIND RIVETS
RIVETS OBTURATEURS MULTI-GRIP**

239
Series

These blind rivets cover the grip range of three standard rivets. Excellent where a combination of hard and soft materials needs fastening. Compensates for hole size and alignment variations. Aluminum body and steel mandrel. Domed head.

ORDER BY STOCK NUMBER

Standard Package: 100 Rivets.

Stock No.	Other No.	Rivet Dia.	Grip Range	Rivet Length
239-314	AD41-43	1/8 (.125)	.031-.185	.315
239-320	AD43-45	1/8 (.125)	.157-.335	.480
239-335	AD52-54	5/32 (.156)	.047-.248	.425
239-353	AD62-64	3/16 (.187)	.063-.252	.414

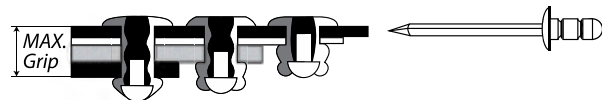

**BACK-UP PLATES
PLAQUES DE RENFORT**

239
Series

- 239-493 Back-up plates for 1/8" Dia. Rivets (9/64 x 3/8 x 1/32) Plated Steel, 100 per box.
- 239-494 Back-up plates for 3/16" Dia. Rivets (13/64 x 1/2 x 3/64) Plated Steel, 100 per box.
- 239-492 Back-up plates for 3/16" Dia. Rivets (13/64 x 1/2 x 3/64) Aluminum, 100 per box.



239-493

**PLASTIC RIVETS
RIVETS EN PLASTIQUE**

247
Series

Papco[®] Plastic Expansion Rivets are used to fasten panels, fascia strips, inner fenders, grilles, shields etc. Moulded of nylon, the three leg design draws panels tightly together as the mandrel breaks off.

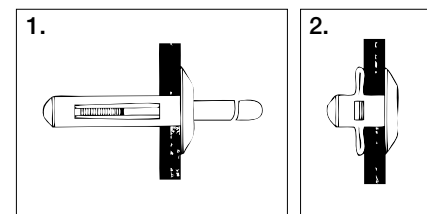

ORDER BY STOCK NUMBER

Standard Package: 25 Pieces

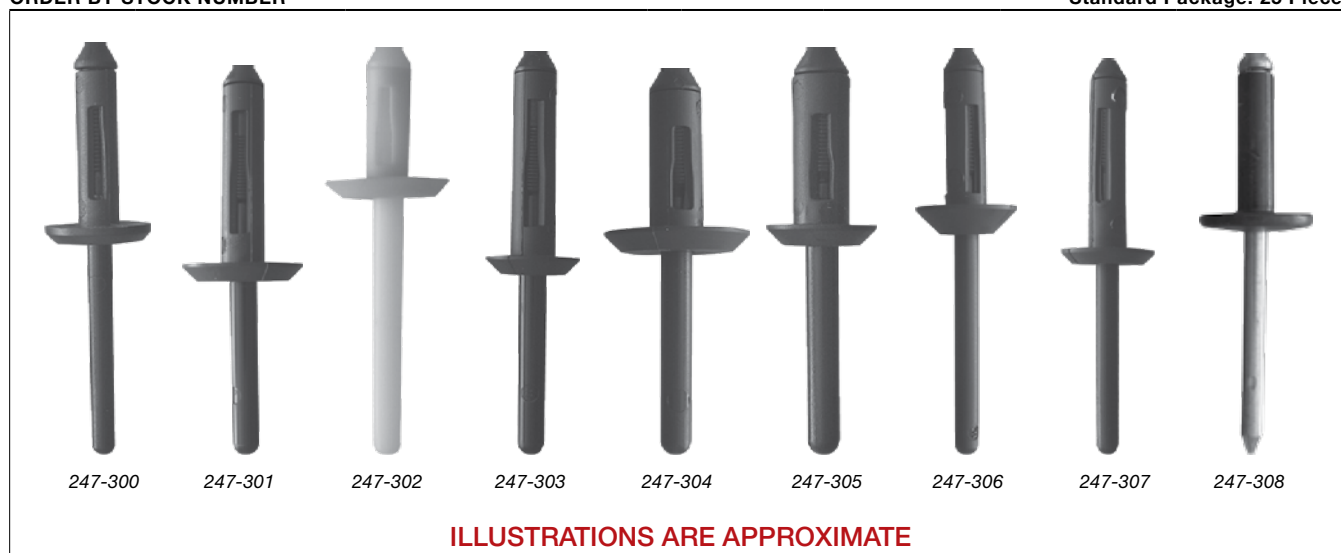

ILLUSTRATIONS ARE APPROXIMATE

Stock No.	OEM No.	Rivet Dia.	Max . Grip	Head Flange Dia.	Drill Size
247-300	Chrysler: 6500899, GM: 20432975 VW: 175-853-57701C	5 mm	6 mm	12 mm	7/32
247-301	Chrysler: 6500911 Ford: N803043-S GM: 14063981	6.3	10	17	1/4
247-302	GM: 14070914 (White)	6.3	6	17	1/4
247-303	Ford: N803862-S GM: 20452072	6.3	10	13	
247-304	GM: 20433026 VW: 175-853-577A	6.6	5	17	9/32
247-305	GM: 20421672	6.6	5	13	9/32
247-306	Ford: N804189S, GM: 2042367	5	4.5	12	7/32
247-307	Chrysler: 6500898	5	10	12	7/32
247-308	388664-S100 (Black) Ford Fascia & Bumper (Aluminum)	3/16"	1/2"	9/16"	—

For Papco[®] Plastic Rivets Master Assortment No. 020-693 see page 8.

PLASTIC RIVET SETTING TOOL

No. 247-330

This sturdy steel tool sets all sizes of plastic rivets. The long reach gets into tight areas and the extra leverage allows fast, one-stroke setting. Used with Plastic Rivets above. Order by stock number. Individually packaged.



247-330

BLIND WELL NUTS
ÉCROUS PUIITS OBTURATEURS

239
Series

Consists of a flanged neoprene bushing with a captive brass insert nut. As the screw is tightened the bushing expands making a secure fastening in thin sheet metal or blind holes. Use to mount accessories on cars, vans, trucks, snowmobiles, fibreglass boats etc.

ORDER BY STOCK NUMBER

Standard Package: 10 Nuts

Stock No.	Thread Size	Hole Size	Panel Thick. Max.	Flange Dia.	Shank Length
239-974	6-32	5/16	.156	.462	.437
239-976	8-32	5/16	.156	.438	.447
239-985	10-32	3/8	.227	.750	.620
239-991	1/4-20	1/2	.187	.625	.642

BLIND WELL NUT GARAGE ASSORTMENT

No. 020-081

Contains 20 nuts in 6-32, 8-32, 10-32, and 1/4-20. Packed in a clear plastic box.

020-081



MIRROR MOUNTING 'JACK' NUT

No. 239-960

Made of 1010 Zinc Plated Steel this 1/4-20 Jack Nut with sealer has been designed for mounting outside mirrors to body panels. Legs of nut expand as screw is driven providing a positive, water-tight connection. Used with Papco[®] Body Bolt No. 245-610 on page 142. May also be used to attach licence plates. Standard package 25 Pieces.

239-960



'SERT-A-NUTS'
ÉCROUS D'ANCRAGE

222
Series

Papco[®] Aluminum 'Sert-a-Nuts' may be used in sheet metal, plastic, castings, fibreglass, or any rigid material. 'Sert-a-Nut' has an unlimited grip range and no thickness barrier. Eliminates the need for tapping, welding or brazing. Kits include Setting Tool, Socket Screw and Hex Key.

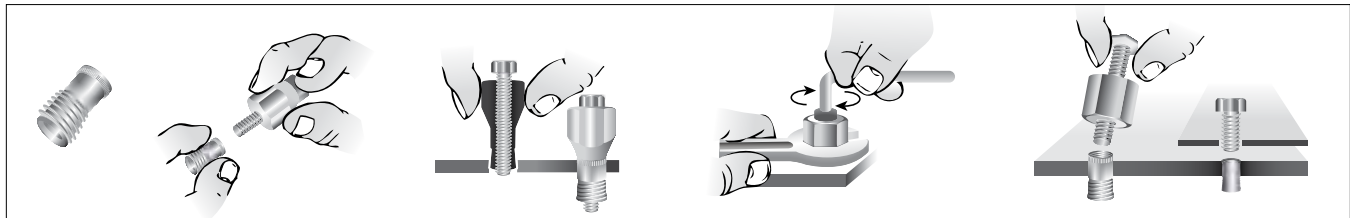

1. Place screw through tool and thread into 'Sert-a-Nut' flange side up.
2. Insert 'Sert-a-Nut' into pre-drilled hole.
3. Hold tool with wrench, turn screw with key until tight.
4. 'Sert-a-Nut' is now anchored solidly into hole.

ORDER BY STOCK NUMBER

Stock No.	Size	Drill	Standard Package	Stock No.	Size	Drill	Inserts Per Kit
'SERT-A-NUTS'				'SERT-A-NUT' KITS			
222-304	6-32	7/32	25	222-314	6-32	7/32	5
222-306	8-32	1/4	25	222-316	8-32	1/4	5
222-308	10-24	9/32	25	222-318	10-24	9/32	5
222-310	1/4-20	3/8	25	222-320	1/4-20	3/8	5

'SERT-A-NUT' GARAGE ASSORTMENT

No. 020-090

Contains 4 complete kits for 6-32, 8-32, 10-24 and 1/4-20 'Sert-a-Nuts'. Four sizes in a clear plastic box.

020-090



AN INTRODUCTION TO...

EXPANSION PLUGS

BOUCHONS D'EXPANSION

...UNE INTRODUCTION.

www.hpaulin.com

For a full listing of Papco®
Expansion Plugs and application
guide, please refer to our current
catalogue or visit our website to
download a PDF version.



EXPANSION PLUG KITS

- BRASS
- STEEL

EXPANSION PLUGS (IMPERIAL AND METRIC)

- CUP TYPE
- SHALLOW CUP TYPE
- STANDARD CUP TYPE

'E-Z SEAL' EXPANSION PLUGS



**EXPANSION PLUG KITS
TROUSSES DE BOUCHONS D'EXPANSION**

**260
Series**

- **DOMESTIC - IMPORT - TRUCKS - MARINE**
A time-saving kit for machine shops, engine rebuilders and Jobbers. Expansion plugs for each engine skin-packed in one convenient package. Coverage for Domestic and Import engines.



BRASS / MARINE

Year	Cyl.	Application	Kit No.
GM, MERCURY, OMC			
All	(V8)	4.6L (283 C.I.)	260-488
All	(V8)	5.0L (305 C.I.)	260-488

STEEL

Year	Cyl.	Application	Kit No.
AMC			
1997-87	(V6)	4.0L (244)	260-401
1988-71	(V6)	4.2L (258)	260-402

BUICK			
1992-80	(4)	2.5L (151)	260-400
1989-80	(V6)	2.8L (173) W, X, Y, Z	260-407
2010-85	(V6)	3.0L (181) E, L 3.8L (231) A, B, G, 2, 3, 7, 8, 9	260-406
1992-77	(V8)	5.0L (305)	260-425
1990-80	(V8)	4.3L (260) <i>Diesel</i> ; 5.0L (307) Y 5.7L (350) N <i>Diesel</i>	260-413

CADILLAC			
1992-88	(V6)	4.5L (273)	260-415
1993-86	(V8)	5.0L (307) Y 5.7L (350) N <i>Diesel</i>	260-413

CHEVROLET			
2002-90	(4)	2.2L (134)	260-425
1992-78	(4)	2.5L (151)	260-400
1989-80	(V6)	2.8L (173) W, X, Z, I	260-407
2005-88	(V6)	3.8L (231) I, K, L	260-410
1990-85	(V6)	4.3L (262)	260-413
1993-91	(V6)	4.3L (262) Z	260-412
2010-57	(V8)	265, 267, 283, 302, 305, 307, 327, 350 to 1996	260-425

CHEVY/GMC			
1993-82	(V6)	2.8L (173)	260-407
2012-85	(V6)	4.3L (262) N, Z	260-412
1990-63	(V6)	4.8L (292)	260-415
2005-76	(V8)	5.0L (305), (307); 5.4L (327)	260-425
2002-73	(V8)	5.7L (350)	260-425
2000-70	(V8)	6.0L (366); 7.4L (454)	260-426
2002-82	(V8)	6.2L (379) <i>Diesel</i> , (395) <i>Diesel</i>	260-421

Year	Cyl.	Application	Kit No.
CHRYSLER/DODGE			
2000-82	(4)	2.2L (135) OHC 2.5L (153) OHC	260-434
2003-88	(V6)	3.0L (181)	260-430
2010-94	(V6)	3.3L (201)	260-436
2010-90	(V6)	3.3L (201); 3.5L (215); 3.8L (230)	260-432

FORD/FORD TRUCK			
2011-84	(4)	2.3L (140) OHC	260-446
2009-86	(V6)	3.0L (182) exc. SHO engine	260-448
2004-82	(V6)	3.8L (232)	260-442
1996-65	(V6)	4.9L (300, 300) LD	260-450
2012-97	(V8)	4.6L (281)	260-457
2001-68	(V8)	4.7L (289); 5.0L (302) 5.8L (351) W	260-451
1997-73	(V8)	6.1L (370); 7.0L (429) 7.5L (460)	260-455

OLDSMOBILE			
1995-89	(4)	2.3L (138)	260-418
1992-78	(4)	2.5L (151) 1, 5, 9, R, V	260-400
1989-79	(V6)	2.8L (173) W, X, Z	260-407
2000-88	(V6)	3.0L (181) E, L 3.8L (231) A, B, C, 2, 3 4.1L (252)	260-410
2001-91	(V8)	4.3L (260) F, 8, (260) <i>Diesel</i> 5.0L (307) Y 5.7L (350) R, (350) N <i>Diesel</i>	260-413
1992-77	(V8)	4.4L (267) J 5.0L (305), (350) G, L	260-425

PONTIAC			
1991-87	(4)	1.8L (112) J, O, OHC, 112G 2.0L (122) B, K, M, P	260-418
1991-77	(4)	2.5L (151) F, R, U, V, 1, 2, 5, 9	260-400
1989-79	(V6)	2.8L (173) L, S, W, X, Z, 1, 7, 9	260-407
2008-85	(V6)	3.0L (181) E, L, 3.8L (231) A, B, C, 2, 3 4.1L (252)	260-410
1992-77	(V8)	5.0L (305); 5.7L (350L)	260-425
2004-87	(V8)	5.7L (350R), (350N) <i>Diesel</i> 6.6L (403)	260-413

EXPANSION PLUGS BOUCHONS D'EXPANSION

**260
Series**

- Also known as Frost Plugs, Welsh Plugs or Freeze-Out Plugs. Papco® Expansion Plugs are made of heavy gauge plated steel or solid brass to resist rust.

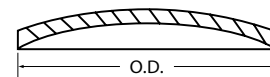

STANDARD TYPE TYPE REGULIER Standard Package / Contenant Régulier : $\frac{3}{8} - 1 \frac{5}{8} = 25$ pcs. $1 \frac{47}{64} - 3 = 12$ pcs.

Stock No. STEEL	Stock No. BRASS	Nominal Plug Size	Reference O.D. +/- .005
260-006	260-506	3/8	.375
260-008		7/16	.437
260-010	260-510	1/2	.500
260-012		9/16	.563
260-014		5/8	.625
260-016		1-11/16	.687
260-018	260-518	3/4	.750
260-020		13/16	.812
260-022		27/32	.844
260-024	260-524	7/8	.875
260-026	260-526	15/16	.936
260-028	260-528	1	1.000
260-030	260-530	1-1/32	1.031
260-032	260-532	1-1/16	1.063
260-034	260-534	1-1/8	1.125
260-036	260-536	1-3/16	1.188

Stock No. STEEL	Stock No. BRASS	Nominal Plug Size	Reference O.D. +/- .005
260-039	260-539	1-1/4	1.250
260-042		1-5/16	1.313
260-045	260-545	1-3/8	1.375
260-048	260-548	1-7/16	1.437
260-051	260-551	1-31/64	1.484
260-054		1-1/2	1.500
260-057	260-557	1-5/8	1.625
260-060		1-47/64	1.734
260-063	260-563	1-3/4	1.750
260-066	260-566	1-7/8	1.875
260-069	260-569	2	2.000
260-072		2-1/16	2.063
260-075	260-575	2-7/64	2.105
260-078	260-578	2-1/4	2.250
260-081		2-1/2	2.500
260-084		2-3/4	2.750

CUP TYPE TYPE D'ASSIETTE

Standard Package / Contenant Régulier = 12 pcs.

Plated Steel or Solid Brass / Acier Plaqué ou laiton massif

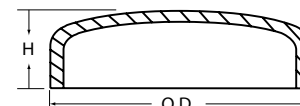

Stock No. STEEL	Stock No. BRASS	Nominal Plug Size	Reference O.D. +/- .005	H-Overall Height
260-100		1/4	.260	.135
260-103		5/16	.3135	.296
260-105		3/8	.385	.240
260-108		7/16	.450	.210
260-110	260-610	7/16	.4445	.156
260-111		25/64	.404	.265
260-112		29/64	.460	.270
260-113		15/32	.475	.200
260-114		1/2	.527	.312
260-115		1/2	.511	.258
260-116		35/64	.5425	.250
260-117		33/64	.512	.248
260-118		9/16	.583	.250
260-120		19/32	.594	.281
260-121		9/16	.571	.250
260-125		21/32	.658	.266
260-126	260-626	5/8	.6325	.250
260-127		43/64	.662	.235
260-128		11/16	.700	.250
260-129		41/64	.635	.233
260-130	260-630	3/4	.7525	.250
260-133		51/64	.789	.312
260-134		13/16	.812	.312
260-136		7/8	.888	.312
260-138	260-638	29/32	.912	.390
260-140	260-640	59/64	.925	.335
260-141		7/8	.869	.312
260-142		15/16	.945	.375
260-143		61/64	.951	.272
260-144	260-644	1	1.014	.281
260-145		1	1.009	.295
260-146		1-1/16	1.073	.280
260-147		1-5/64	1.072	.280
260-150	260-650	1-1/8	1.133	.437
260-153		1-13/64	1.200	.420
260-156		1-7/32	1.228	.531

Stock No. STEEL	Stock No. BRASS	Nominal Plug Size	Reference O.D. +/- .005	H-Overall Height
260-162*		1-1/4	1.2575	.343
260-165		1-1/4	1.258	.437
260-168		1-3/8	1.3875	.500
260-171		1-7/16	1.438	.431
260-174		1-1/2	1.522	.375
260-177		1-1/2	1.506	.325
260-180	260-680	1-1/2	1.5075	.625
260-183		1-9/16	1.576	.600
260-186	260-686	1-5/8	1.6375	.593
260-189		1-41/64	1.642	.350
260-192*		1-45/64	1.7075	.812
260-193		1-45/64	1.638	.350
260-194	260-694	1-3/4	1.7625	.363
260-198	260-698	1-3/4	1.7625	.593
260-204		1-3/4	1.750	.356
260-207	260-707	1-49/64	1.7655	.406
260-210	260-710	1-7/8	1.8925	.447
260-213		1-57/64	1.883	.266
260-216		1-29/32	1.902	.600
260-219	260-719	1-15/16	1.9475	.800
260-222	260-722	1-61/64	1.9555	.718
260-224		1-61/64	1.956	.295
260-225		1-63/64	2.000	.800
260-228	260-728	2	2.009	.635
260-231		2	2.008	.415
260-234	260-734	2-1/64	2.0175	.590
260-237	260-737	2-1/16	2.0675	.510
260-240		2-3/32	2.0975	.610
260-243	260-743	2-1/8	2.145	.430
260-246		2-9/64	2.1485	.600
260-249		2-3/16	2.199	.360
260-252	260-752	2-1/4	2.265	.812
260-255		2-17/64	2.264	.355
260-260		2-1/2	2.504	.350
260-262		2-1/2	2.500	.340

**EXPANSION PLUGS
BOUCHON D'EXPANSION**

**260
Series**

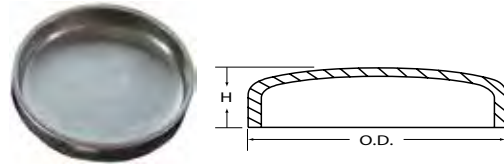

SHALLOW CUP TYPE TYPE D'ASSIETTE PEU PROFOND Standard Package / Contenant Régulier =12 pcs.

Plated Steel or Solid Brass / Acier Plaqué ou laiton massif

Stock No. STEEL	Stock No. BRASS	Nominal Plug Size	Reference O.D. +/- .005	H-Overall Height
260-303		7/16	.440	.170
260-305		29/64	.450	.203
260-307		1/2	.505	.250
260-308		17/32	.541	.187
260-309		35/64	.5425	.187
260-311		5/8	.631	.190
260-312		45/64	.700	.205
260-313		53/64	.8235	.250
260-315	260-815	1	1.010	.290
260-318	260-818	1-1/4	1.2625	.312
260-321		1-21/64	1.3225	.281
260-324	260-824	1-3/8	1.385	.340
260-327	260-827	1-1/2	1.505	.300
260-330		1-9/16	1.570	.315
260-333	260-833	1-5/8	1.640	.345
260-336		1-45/64	1.703	.281
260-339	260-839	1-3/4	1.762	.232
260-342		1-51/64	1.8025	.250

Stock No. STEEL	Stock No. BRASS	Nominal Plug Size	Reference O.D. +/- .005	H-Overall Height
260-345		1-53/64	1.825	.350
260-348		1-29/32	1.915	.265
260-351		1-59/64	1.922	.235
260-354		1-31/32	1.9775	.218
260-357		2	2.025	.406
260-359	260-859	2	2.010	.310
260-362		2-1/64	2.0175	.240
260-365	260-865	2-1/16	2.0725	.343
260-366		2-1/16	2.062	.343
260-372		2-7/64	2.109	.310
260-375		2-9/64	2.135	.360
260-378		2-5/32	2.1535	.328
260-381	260-881	2-3/16	2.200	.355
260-383		2-3/16	2.192	.343
260-385		2-7/32	2.2205	.305
260-388		2-1/4	2.262	.350
260-391		2-3/8	2.385	.312
260-394*		2-9/16	2.575	.301

* With reverse taper

GARAGE ASSORTMENT

No. 020-048

Contains 50 Standard and Cup Type expansion plugs.
For more details see page 3.



MASTER ASSORTMENTS

No. 020-633

Contains 110 Cup & Shallow Cup Types.
For more details see page 8.

020-633



No. 020-640

Contains 140 Standard & Cup Types.
For more details see page 8.

020-640



'SUPER SERVICE' ASSORTMENTS

No. 020-800

Contains 200 Standard & Cup Types.
See page 10 for more details.

No. 020-801

Contains 170 Cup & Shallow Cup Types.
See page 10 for more details.

020-800

**METRIC EXPANSION PLUGS
BOUCHON D'EXPANSION MÉTRIQUE**

**261
Series**

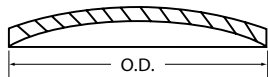

STANDARD TYPE

TYPE RÉGULIER Plated Steel / Acier Plaqué

Standard Package / Contenant Régulier = 10 pcs.

Stock No.	Nominal O.D.	Stock No.	Nominal O.D.
261-011	16 mm	261-064	40 mm
261-014	18 mm	261-069	42 mm
261-024	24 mm	261-077	45 mm
261-026	25 mm	261-090	52 mm
261-046	35 mm	261-096	55 mm

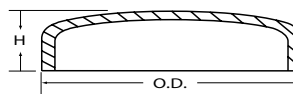

SHALLOW CUP TYPE

TYPE D'ASSIETTE PEU PROFOND

Plated Steel / Acier Plaqué

Standard Package / Contenant Régulier = 10 pcs.

Stock No.	Nominal O.D.	Stock No.	Nominal O.D.
261-326	25 mm	261-367	42 mm
261-347	35 mm	261-377	45 mm
261-364	40 mm		

CUP TYPE TYPE D'ASSIETTE

Standard Package / Contenant Régulier = 10 pcs.

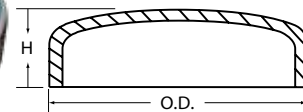

Stock No.	Nominal O.D.	H - Nominal Height (mm)
261-103	11 mm	4.85
261-105	12 mm	5.3
261-107	14 mm	5.0
261-108	14.4 mm	5.5
261-109	15 mm	5.5
261-111	16 mm	9.1
261-114	18 mm	5.9
261-117	20 mm	7.0
261-118	20 mm	6.0
261-121	22 mm	7.5
261-124	24 mm	6.9
261-126	25 mm	8.3
261-129	27 mm	8.4
261-132	28 mm	8.7
261-135	29 mm	11.4
261-138	30 mm	8.1
261-140	31.5 mm	8.5
261-142	32 mm	9.5
261-145	34 mm	12.7

Stock No.	Nominal O.D.	H - Nominal Height (mm)
261-146	35 mm	10.6
261-149	36 mm	8.5
261-150	36.5 mm	9.0
261-155	38 mm	7.9
261-158	39 mm	9.5
261-161	40 mm	11.7
261-162	40 mm	12.8
261-165	41 mm	11.9
261-170	42.3 mm	10.0
261-171	42.6 mm	10.0
261-173	44 mm	11.9
261-177	45 mm	11.9
261-178	45 mm	13.5
261-181	47 mm	7.4
261-184	49.5 mm	11.0
261-185	50 mm	12.0
261-186	50 mm	14.8
261-188	51 mm	5.55

MASTER ASSORTMENTS



020-666

No. 020-666

Contains 120 Metric Standard & Cup Types.
See page 8 for more details.

'SUPER SERVICE' ASSORTMENTS



020-840

No. 020-840

Contains 180 Metric Standard & Cup Types.
See page 10 for more details.

No. 020-841

Contains 150 Metric Cup & Shallow Cup Types.
See page 10 for more details.

'E-Z SEAL' EXPANSION PLUGS
BOUCHONS D'EXPANSION 'E-Z SEAL'

263
Series

An Expansion Plug designed to save mechanic's time... will save hours of repair time in replacing core hole plugs, by simply tightening, even when Starter, Generator, Distributor, Manifold, Steering Linkage or Air Conditioner Components interfere.

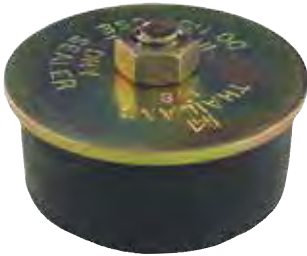

- Slips in easily.
- Can be finger-tightened.
- Permanently set with open end wrench.
- No metal comes in contact with the coolant.
- Body of plug is specially compounded Neoprene, resistant to heat, antifreeze, and rust inhibitors.
- Expands as much as 1/8" to seal tightly against irregularities.

EXPANSION PLUGS

Order by Stock Number

Stock No.	Size	Metric Equiv.
263-548	3/4	19 mm
263-556	7/8	22 mm
263-564	1	25 mm
263-572	1-1/8	29 mm

Stock No.	Size	Metric Equiv.
263-580	1-1/4	32 mm
263-588	1-3/8	35 mm
263-596	1-1/2	38 mm
263-604	1-5/8	41 mm

Stock No.	Size	Metric Equiv.
263-612	1-3/4	45 mm
263-628	2	51 mm
263-636	2-1/8	54 mm
263-644	2-1/4	57 mm

OIL DRAIN PLUGS

Stock No.	Size	Metric Equiv.
'E-Z SEAL' OIL DRAIN PLUGS		
263-290	7/16	12 mm
263-320	1/2	13 mm
263-322	9/16	14 mm
263-400	5/8	16 mm

- Install dry.
- Do not use sealer.
- Do not use where petroleum products contact rubber.
- Do not overtighten.
- *Installez à sec.*
- *N'employez pas de l'adhésif.*
- *N'employez pas où des produits de pétrole viendront en contact avec le néoprène.*
- *Ne pas trop serrer.*

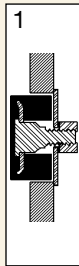

- Make sure washer and nut are loose. *Assurez-vous que la rondelle et l'écrou ne sont pas lâches.*
- Washer must be flush with side of wall before and after plug is installed. *La rondelle doit être égale avec le côté du mur avant d'être installée.*
- Plug must extend 1/4" beyond inside wall to allow a ridge to form. *Le tampon doit dépasser le mur intérieure d'aux moins 1/4 de pouce pour permettre la formation d'un coussin.*
- Turn the nut clockwise 2 or 3 turns to form a ridge and properly set plug. *Pour bien placer le tampon, serrez l'écrou de 2 ou 3 tours.*
- When properly installed, plug will hold pressure to 50 P. S. I. *Quand bien installé, le tampon soutiendra une pression de 50 P. S. I.*

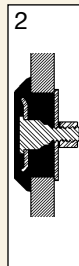

MERCHANDISER No. 022-123

Includes Rack, Header Sign, Inventory Control, Planogram and a 20 card stock of 'E-Z Seal Plugs' listed above.



ASSORTMENT No. 020-318

Contains 13 'E-Z Seal' Expansion Plugs - one of each size. Have every size on hand - repair leaking metal frost plugs in all locations - whether hard or easy to get to.

Contient 13 bouchons d'expansion 'E-Z Seal' - un de chaque format. Ayez tous les formats en main. Réparez les bouchons en métal protégeant contre la gelée à tous les endroits - difficiles ou faciles à rejoindre.



AN INTRODUCTION TO...

DRAIN PLUGS

BOUCHONS DE VIDANGE

...UNE INTRODUCTION.

www.hpaulin.com

For a full listing of Papco® Oil Drain Plugs and application guide, please refer to our current catalogue or visit our website to download a PDF version.



DRAIN AND FILLER PLUGS

DRAIN PLUGS GASKET

OIL DRAIN PLUG REPAIR

DUO-DRAIN OIL PLUG

**CARDED MAGNETIC DRAIN
with GASKET**

**MAGNETIC DRAIN PLUG
with GASKET**



**DRAIN AND FILLER PLUGS
BOUCHONS DE VIDANGE ET REMPLISSAGE**

**263
Series**

Papco[®] Drain Plugs are manufactured in nine types and are available in Inch and Metric sizes. Type 2 oversize plugs are tapered, hardened and cut their own thread where the original has been stripped. To use an oversize plug, hold in a straight position and tighten with a socket wrench. Plug is then removed to clear metal particles and then reinstalled. Each Drain Plug is supplied with a gasket, as indicated in the gasket chart, with an asterisk (*) unless otherwise indicated.

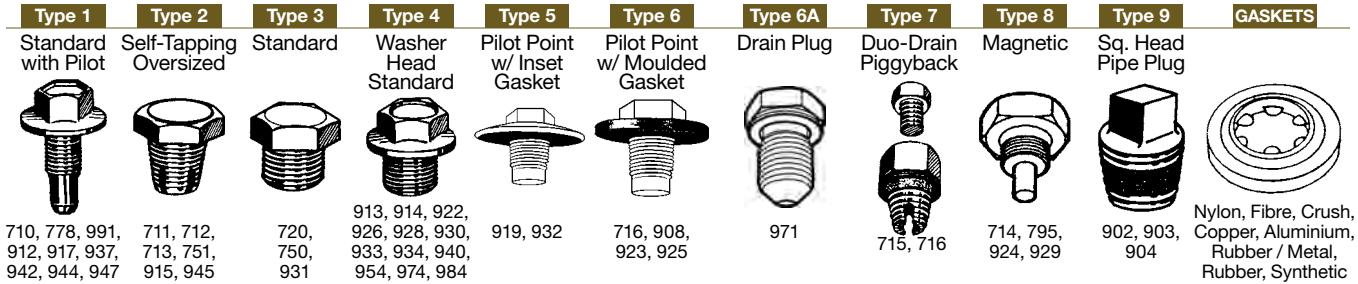

DRAIN PLUGS				GASKETS				All Gasket Standard Packages 25 Pieces			
Stock No.	Size & Thread	Type	Std. Pkg.	Nylon	Fibre	Copper	Crush	Aluminum	Rubber / Metal	Rubber	Synthetic
263-710	1/2-20 Std.	1	5	263-816*	263-800	263-856		263-869	263-875		263-885
263-711	1/2-20 S.O. Self-Tap	2	12	263-816*	263-801	263-856	263-844		263-875		
263-712	1/2-20 D.O. Self-Tap	2	12	263-817*	263-801	263-857		263-870			
263-713	1/2-20 T.O. Self-Tap	2	12	263-817*	263-802	263-860					
263-714	1/2-20 Magnetic	8	5	263-816*	263-800	263-856			263-875		
263-715	1/2-20 D.O. Duo-Drain	7	5	263-817*	263-801	263-857		263-870			
263-716	1/2-20 Std. Duo-Drain	7	5	263-816*	263-800	263-856			263-875		
263-718	1/2-20 Pilot Pt. w/ Molded Gasket	6	5	N/R	N/R	N/R	N/R	N/R	N/R	N/R	N/R
263-720	5/8-18 Std.	3	5	263-820*		263-857					
263-750	3/4-16 Std.	3	5	260-824*	263-804		263-851				
263-751	3/4-16 S.O. Self-Tap	2	5	263-824*	263-805		263-851				
263-778	1/2-20 Std.	1	5	263-816	263-800	263-856		263-869	263-875*		263-885
263-795	1/2-20 Magnetic	8	5	263-816	263-800	263-856		263-869	263-875*		263-885
263-908	M12 x 1.75 Pilot Pt. w/ Moulded Gasket	6	5	N/R	N/R	N/R	N/R	N/R	N/R	N/R	N/R
263-911	M12 x 1.75 Std. with Pilot Pt.	1	5	263-815*	263-808	263-855		263-869	263-875	263-874	
263-912	M12 x 1.25 Std. with Pilot Pt.	1	5	263-815*	263-808	263-855		263-869	263-875	263-874	
263-913	M12 x 1.25 Std.	4	5	263-815*	263-808	263-855		263-869	263-875	263-874	
263-914	M14 x 1.5 Std.	4	5	263-817*	263-801	263-856	263-844	263-870	263-876		
263-915	M14 x 1.5 S.O. Self-Tap	2	5	263-817*		263-860					
263-917	M14 x 1.5 Std. with Pilot	1	5	263-817*	263-801	263-856	263-844	263-870	263-876		
263-919	M12 x 1.75 Pilot Pt. w/Inset Gasket	1	5	N/R	N/R	N/R	N/R	N/R	N/R	N/R	N/R
263-922	M14 x 1.25 Std.	4	5	263-817*	263-801	263-856	263-844	263-870	263-876		
263-923	M14 x 1.5 Pilot Pt. w/ Molded Gasket	6	5	N/R	N/R	N/R	N/R	N/R	N/R	N/R	N/R
263-924	M14 x 1.5 Magnetic	8	5	263-817*	263-801	263-856	263-844	263-870	263-876		
263-925	M14 x 1.5 Pilot Pt. w/ Inset Gasket	6	5	N/R	N/R	N/R	N/R	N/R	N/R	N/R	N/R
263-928	M18 x 1.5 Std.	4	5	263-824	263-810*			263-873			
263-929	M12 x 1.75 Magnetic w/PP & Inset Gasket	8	5	N/R	N/R	N/R	N/R	N/R	N/R	N/R	N/R
263-930	M20 x 1.5 Std.	4	5	263-824	263-807		263-851*				
263-931	M12 x 1.5 Std.	3	5	263-815	263-808	263-855		263-869*	263-875	263-874	
263-932	M12 x 1.75 Pilot Pt. w/ Inset Gasket	5	5	N/R	N/R	N/R	N/R	N/R	N/R	N/R	N/R
263-933	M12 x 1.25 Std.	4	5	263-815	263-808	263-855		263-869	263-875	263-874	263-885*
263-934	M14 x 1.5 Std.	4	5	263-817	263-801	263-856	263-844	263-870*	263-876		
263-937	M14 x 1.5 Pilot Pt.	1	5	263-817	263-801	263-856	263-844	263-870	263-876*		
263-940	M22 x 1.5 Std.	4	5	263-828*							
263-942	M12 x 1.25 Pilot Pt.	1	5	263-815	263-808	263-855		263-869*	263-875	263-874	263-885
263-944	M12 x 1.75 Pilot Pt.	1	5	263-815	263-808	263-855		263-870	263-875*	263-874	
263-945	M12 x 1.75 S.O. Self-Tap	2	5	263-817	263-801	263-855	263-844	263-870	263-876*		
263-947	M14 x 1.5 Pilot Pt.	1	5	263-817	263-801	263-856*	263-844	263-870	263-876		
263-950	M14 x 1.5 Std. w/Inset Gasket	5	5	N/R	N/R	N/R	N/R	N/R	N/R	N/R	N/R
263-954	M14 x 1.5 Std.	4	5	263-817	263-801	263-856*	263-844	263-870	263-876		
263-958	M14 x 1.5 Pilot Pt. w/ Inset Gasket	5	5	N/R	N/R	N/R	N/R	N/R	N/R	N/R	N/R
263-960	M 14 x 1.5 Std.	5	5	263-817	263-801	263-856	263-844	263-870*	263-876		
263-971	M14 x 1.5 Std. w/Floating Gasket	6A	5	N/R	N/R	N/R	N/R	N/R	N/R	N/R	N/R
263-974	M14 x 1.5 Std.	4	5	263-817	263-801	263-856	263-844*	263-870	263-876		
263-984	M14 x 1.5 Std.	4	5	263-817	263-801	263-856	263-844	263-870	263-876*		
263-990 †	UNIV. 1/2-3/4, 12-18mm	-	3	N/R	N/R	N/R	N/R	N/R	N/R	N/R	N/R
260-902	1/4" Sq. Pipe Plug	9	12								
260-903	3/8" Sq. Pipe Plug	9	12								
260-904	1/2" Sq. Pipe Plug	9	12								

* - Indicates type of gasket supplied with plug.

**FOR A MORE COMPREHENSIVE LISTING OF THESE PARTS,
PLEASE REFER TO OUR CURRENT OIL DRAIN PLUGS CATALOGUE**

DRAIN PLUG GASKETS JOINTS POUR BOUCHONS DE VIDANGE

263 Series

Papco[®] Selon[®] Drain Plug Gaskets are made of special nylon with excellent mechanical properties and long life. Also available are copper and fibre gaskets as well as aluminium, rubber/metal and synthetic gaskets.



Fibre



Nylon



Crush



Copper



Alum.



Rubber



Synthetic

Order by Stock Number

Standard Packages 25 Pieces

Part #	I.D. x O.D. x Thick	Part #	I.D. x O.D. x Thick	Part #	I.D. x O.D. x Thick
263-800	Fibre 1/2 x 3/4 x 3/32	263-816	Nylon 9/16 x 13/16 x .052	263-860	Copper 3/4 x 1-1/16 x .062
263-801	Fibre 9/16 x 13/16 x 3/32	263-817	Nylon 5/8 x 15/16 x .059	263-869	Alum. 15/32 x 7/8 x .080
263-802	Fibre 5/8 x 7/8 x 3/32	263-820	Nylon 11/16 x 1 x .062	263-870	Alum. 14mm x 20mm x .078
263-804	Fibre 3/4 x 1-1/16 x 3/32	263-824	Nylon 13/16 x 1-1/16 x .082	263-873	Alum. 18mm x 26mm x .078
263-805	Fibre 13/16 x 1 x 3/32	263-828	Nylon 31/64 x 1-1/4 x .078	263-874	Rubber 12mm x 20mm x .102
263-807	Fibre .920 x 1-1/8 x 3/32	263-844	Crush 17/32 x 3/4 x .080	263-875	Rubber/Met.12mm x 25mm x .078
263-808	Fibre 12mm x .748 x 3/32	263-851	Crush 25/32 x 1 x .087	263-876	Rubber/Met.17/32 x 31/32 x .081
263-809	Fibre 16mm x 1.062 x 3/32	263-855	Copper 31/64 x 3/4 x .094	263-885	Synthetic 15/32 x 15/16 x .078
263-810	Fibre 18mm x 1.062 x 3/32	263-856	Copper 19/32 x 13/16 x .062		
263-815	Nylon 31/64 x 3/4 x .052	263-857	Copper 5/8 x 1 x .062		

OIL DRAIN PLUG REPAIR RÉPARATION DE BOUCHON DE VIDANGE

263 Series

No. 263-990

Exclusively patented winged drain plug is used when the oil pan or flange is broken or missing.

Eliminating the need to replace the pan.

Part number 263-990 is a time and money saver for pans with 1/2" to 3/4" or 12mm to 18mm drain holes.

Requires no tools to install.



263-990

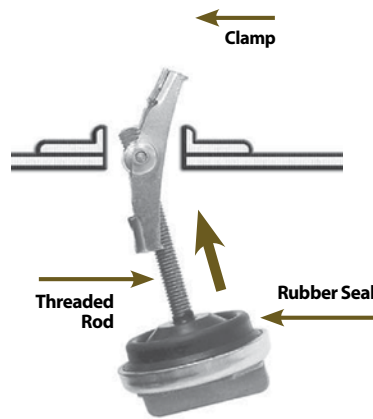

Fig. 1

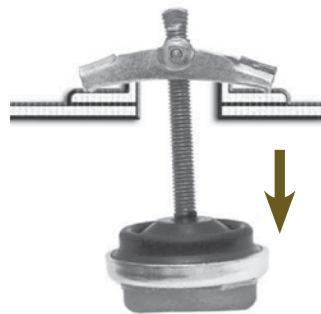

Fig. 2



Fig. 3

CAUTION: DO NOT use on Honda or Volkswagen. Make sure threaded bolt will not contact any internal parts before installation. Bolt enters oil pan 1-7/8".

CAUTION: This type of plug is designed to be HAND TIGHTENED ONLY.

DUO-DRAIN[®] OIL PLUGS
BOUCHONS D'HUILE DUO-DRAIN[®]

263
Series

BRIGHT PLATED

All metal, two-part plug for repairing 1/2"-20 crankcase applications on GM, Ford, Chrysler and AMC. STANDARD or Self-tapping DOUBLE OVERSIZE outer plug installs permanently. Only the pipe threaded centre plug is removed to drain oil. Convenient skin-packed card contains one (1) Duo-Drain Oil Plug complete with gasket.

1/2 Standard

No. 263-798



1/2-20 D.O.

No. 263-799



CARDED DRAIN PLUGS WITH GASKET
BOUCHONS DE VIDANGE AVEC JOINT

Card No.	Size & Type	Card No.	Size & Type
263-777	M14 x 1.5 Pilot Pt.	263-790	1/2-20 Std.
263-780	M12 x 1.75 Std. Pilot Pt.	263-791	1/2-20 S.O. Self-Tap
263-782	1/2-20 T.O. Self-Tap	263-792	1/2-20 D.O. Self-Tap
263-783	1/2-20 Magnetic	263-793	1/2-20 T.O. Self-Tap
263-784	M14 x 1.5 Magnetic	263-794	1/2-20 Magnetic
263-786	M14 x 1.5 Pilot Pt.	263-796	M14 x 1.5 Pilot Pt.
263-787	M12 x 1.75 Pilot Pt.	263-797	M12 x 1.75 Magnetic
263-788	M12 x 1.75 Pilot Pt.	263-798	M14 x 1.5
		263-799	1/2-20 Duo

1/2-20 S.O.
M12 x 1.75
Pilot Pt. with
Inset Gasket



263-791

MAGNETIC DRAIN PLUGS WITH GASKET
BOUCHONS DE VIDANGE MAGNÉTIQUE AVEC JOINT

263
Series

Papco[®] Magnetic Drain Plugs reduce wear and protect engines by attracting harmful metal particles circulating in the crankcase oil. Powerful, long-lasting ALNICO magnet. Install in place of ordinary plugs. Individually skin-packed with gasket.

Card No.	Size & Thread	Gasket
263-783	1/2-20 Magnetic	263-817
263-784	14mm x 1.5 Magnetic	263-817

Card No.	Size & Thread	Gasket
263-794	1/2-20 Std. Magnetic	263-816
263-797	M12 x 1.75 Pilot Pt.- with Inset Gasket	—

1/2-20 S.O.
Magnetic



263-783

DRAIN PLUGS WITH GASKET BOUCHONS DE VIDANGE AVEC JOINT

GARAGE ASSORTMENT

No. 020-032

Contains 7 Self-Tapping Oversize Drain Plugs with gaskets. (4) 1/2-20 O.S.; (2) 1/2-20 D. O.; (1) 1/2-20 T.O.



020-032

GARAGE ASSORTMENT

No. 020-038

Contains 9 Inch and Metric Drain Plugs with gaskets. (4) 1/2-20 Std. (3) 12mm x 1.75, (2) 14mm x 1.5.



020-038

GARAGE ASSORTMENT

No. 020-054

Contains 60 Nylon Gaskets in six popular sizes for Inch and Metric Drain Plugs.



020-054

MASTER GASKET ASSORTMENT

No. 020-607

Contains 210 pieces - 20 of the most popular sizes of Nylon, Copper, Fiber, Aluminum and Rubber/Metal Drain Plug Gaskets.



020-607

MASTER DRAIN PLUG ASSORTMENT

No. 020-630

Contains 40 Inch and Metric Drain Plugs; 73 Gaskets - and includes:
 - Magnetic and 1/2-20 oversize plugs.
 - 17 sizes of Plugs, 8 Sizes of Gaskets.
 - Complete coverage for most vehicles.



020-630

**OIL DRAIN PLUGS AND GASKETS MERCHANDISER
PRÉSENTOIR DE BOUCHONS DE VIDANGE ET JOINTS**

No. 998651

- 42 SKUs of the best plugs and gaskets for domestic and import vehicles
- Prepack includes 84 clamshells.
- Planogram space specifications: 11 inches wide x 24 inches tall.
- 42 peg hooks included.
- Merchandise on standard peg board.
- Products include merchandise location code
- Laminated hanging application guide included
- Please contact your local sales representative for additional information

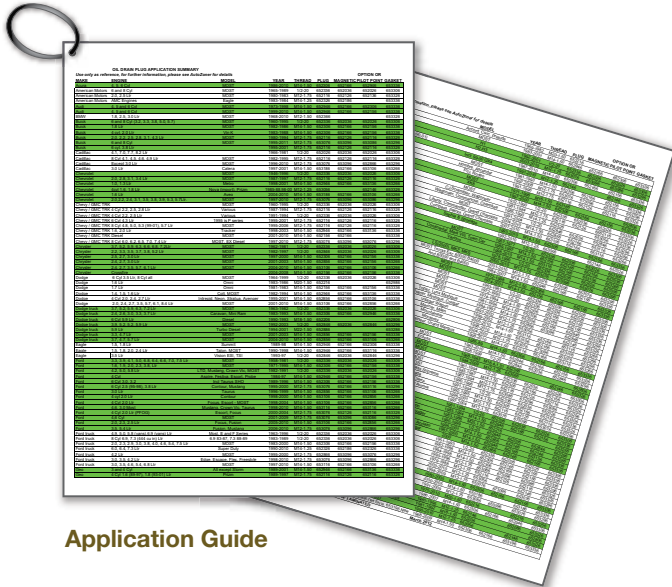

Application Guide

OIL DRAIN PLUGS AND GASKETS MERCHANDISER							
Part No.	Size	Description	Qty	Part No.	Size	Standard	Qty
400804	3/8	Square Pipe Plug	2	652326	M14 x 1.25	Standard	2
400814	1/2	Square Pipe Plug	2	652306	M14 x 1.50	Standard (0.62" shank)	2
652006	1/2	Universal Rubber Plug	2	652946	M14 x 1.50	Standard (0.43" shank)	2
652016	5/8	Universal Rubber Plug	2	652176	M14 x 1.50 S.O.	Single Oversize	2
652026	1/2-20	Standard (0.85" shank)	2	652156	M14 x 1.50	Standard Pilot Point	2
652336	1/2-20	Standard (0.5" shank)	2	653106	M14 x 1.50	Standard Pilot Point w/Inset Gasket (0.71" shank)	2
652846	1/2-20	Standard Pilot Point w/Inset Gasket	2	653116	M14 x 1.50	Standard Pilot Point w/Inset Gasket (0.75" shank)	2
652036	1/2-20	Magnetic Standard	2	652856	M14 x 1.50	Standard Pilot Point w/Inset Gasket (0.67" shank)	2
652046	1/2-20 S.O.	Self-Tap Single Oversize	2	652166	M14 x 1.50	Magnetic Standard	2
652056	1/2-20 S.O.	Magnetic Single Oversize	2	653136	M14 x 1.50	Standard (Easy Seal)	2
652066	1/2-20 D.O.S.	Self-Tap Double Oversize	2	652206	M18 x 1.50	Standard	2
652933	3/4	Rubber Differential Plug	2	652886	M22 x 1.50	Standard	2
653056	M12 x 1.25	Standard	2	653016	12mm	Nylon	2
652116	M12 x 1.75	Standard Pilot Point	2	653296	12mm	Rubber	2
653076	M12 x 1.75	Standard Pilot Point w/Inset Gasket (0.95" shank)	2	652806	M12-M18	Fiber Assortment	2
652866	M12 x 1.75	Standard Pilot Point w/Inset Gasket (0.68" shank)	2	652816	M12-M16	Copper Assortment	2
653086	M12 x 1.75	Standard Pilot Point w/Inset Gasket (0.95" shank)	2	653306	1/2"	Gasket Assortment	2
652126	M12 x 1.75	Magnetic Standard	2	653316	1/2" O.S.	Gasket Assortment	2
653096	M12 x 1.75	Magnetic Standard w/Pilot Point & Inset Gasket	2	653326	M12	Gasket Assortment	2
652136	M12 x 1.75	Self-Tap Single Oversize	2	653336	M14	Gasket Assortment	2
652146	M12 x 1.25	Standard Pilot Point	2	653346	M18-M22	Gasket Assortment	2

RINGS AND KEYSTOCK

ANNEAUX ET CLÉS



SNAP RINGS

SNAP RING PLIERS

WOODRUFF KEYS

'O'-RINGS, UNIVERSAL

AXLE SHAFT KEY STOCK

AXLE KEYS

HOLE PLUGS

MECHANICS' WIRE

**SNAP RINGS
CIRCLIPS**

**268
Series**

High Carbon Steel • Retainer Rings • Heat Treated for Resiliency

Used as retainers on automotive, appliance and heavy equipment applications. Packaged in uniformly priced transparent packs. Number of rings per pack is shown below.

ORDER BY STOCK NUMBER

-200 Series Internal	-300 Series Internal	-400 Series External	-500 Series External	-600 Series External	-700 Series External				
Stock No.	Industry No.	Housing Dia.	Free Dia. "A"	Pieces Per Pack	Stock No.	Industry No.	Shaft Dia.	Free Dia. "A"	Pieces Per Pack
Internal Types (Housing)					External Types (Shaft)				
268-222	5000-50	1/2	.548	10	268-436	5100-131	1-5/16	1.214	4
268-224	5000-62	5/8	.694	10	268-438	5100-137	1-3/8	1.272	4
268-226	5000-75	3/4	.831	8	268-440	5100-150	1-1/2	1.387	3
268-227	5000-81	13/16	.901	8	268-442	5100-175	1-3/4	1.618	2
268-228	5000-87	7/8	.971	6	268-444	5100-200	2	1.850	2
268-230	5000-100	1	1.111	6	268-505	5133-12	1/8	.094	18
268-231	5000-106	1-1/16	1.180	5	268-506	5133-15	5/32	.114	18
268-232	5000-112	1-1/8	1.249	5	268-510	5133-18	3/16	.122	18
268-234	5000-125	1-1/4	1.388	4	268-511	5133-18	3/16	.145	18
268-237	5000-137	1-3/8	1.526	4	268-514	5133-25	1/4	.207	18
268-238	5000-150	1-1/2	1.660	3	268-516	5133-31	5/16	.243	18
268-242	5000-175	1-3/4	1.942	2	268-518	5133-37	3/8	.300	14
268-246	5000-200	2	2.210	2	268-520	5133-43	7/16	.337	14
268-329	5008-093	15/16	1.015	6	268-522	5133-50	1/2	.392	12
268-330	5008-100	1	1.081	6	268-606	5144-15	5/32	.113	18
268-332	5008-112	1-1/8	1.217	5	268-610	5144-18	3/16	.143	18
External Types (Shaft)					268-614	5144-25	1/4	.204	18
268-414	5100-25	1/4	.225	15	268-616	5144-31	5/16	.242	18
268-418	5100-37	3/8	.338	14	268-618	5144-37	3/8	.292	14
268-422	5100-50	1/2	.461	10	268-620	5144-56	9/16	.430	9
268-424	5100-62	5/8	.579	10	268-714	T5304-25	1/4	.187	7
268-426	5100-75	3/4	.693	8	268-716	T5304-31	5/16	.250	6
268-428	5100-87	7/8	.810	7	268-718	T5304-37	3/8	.312	6
268-430	5100-100	1	.925	6	268-722	T5304-50	1/2	.406	5
268-432	5100-112	1-1/8	1.041	5	268-724	T5304-62	5/8	.500	4
268-434	5100-125	1-1/4	1.156	4					

GARAGE ASSORTMENT

No. 020-040

Contains 60 Snap Rings, 9 sizes of 268-500 Series, for 1/8" to 1/2" Dia. shafts.

020-040



MASTER ASSORTMENT

No. 020-627

Contains 401 Snap Rings, 36 sizes. Priced label in lid has actual size ring outlines for easy identification. Metal box has moulded compartments. Has a complete stock of all ring sizes and types listed above. Size: 9-3/4" W x 13-3/4" L x 2" D.

020-817



'SUPER-SERVICE' ASSORTMENT

No. 020-817

Contains 705 Snap Rings - 50 sizes. Large size, rigid metal box with high-strength plastic compartments.

Size: 12" W x 18" L x 3" D.

For more details see page 10.

**SNAP RINGS
CIRCLIPS**

268
Series

Packaged in uniformly priced transparent packs.

*Example of Stock Number: 268-246

ORDER BY STOCK NUMBER

Illustrations Actual Size

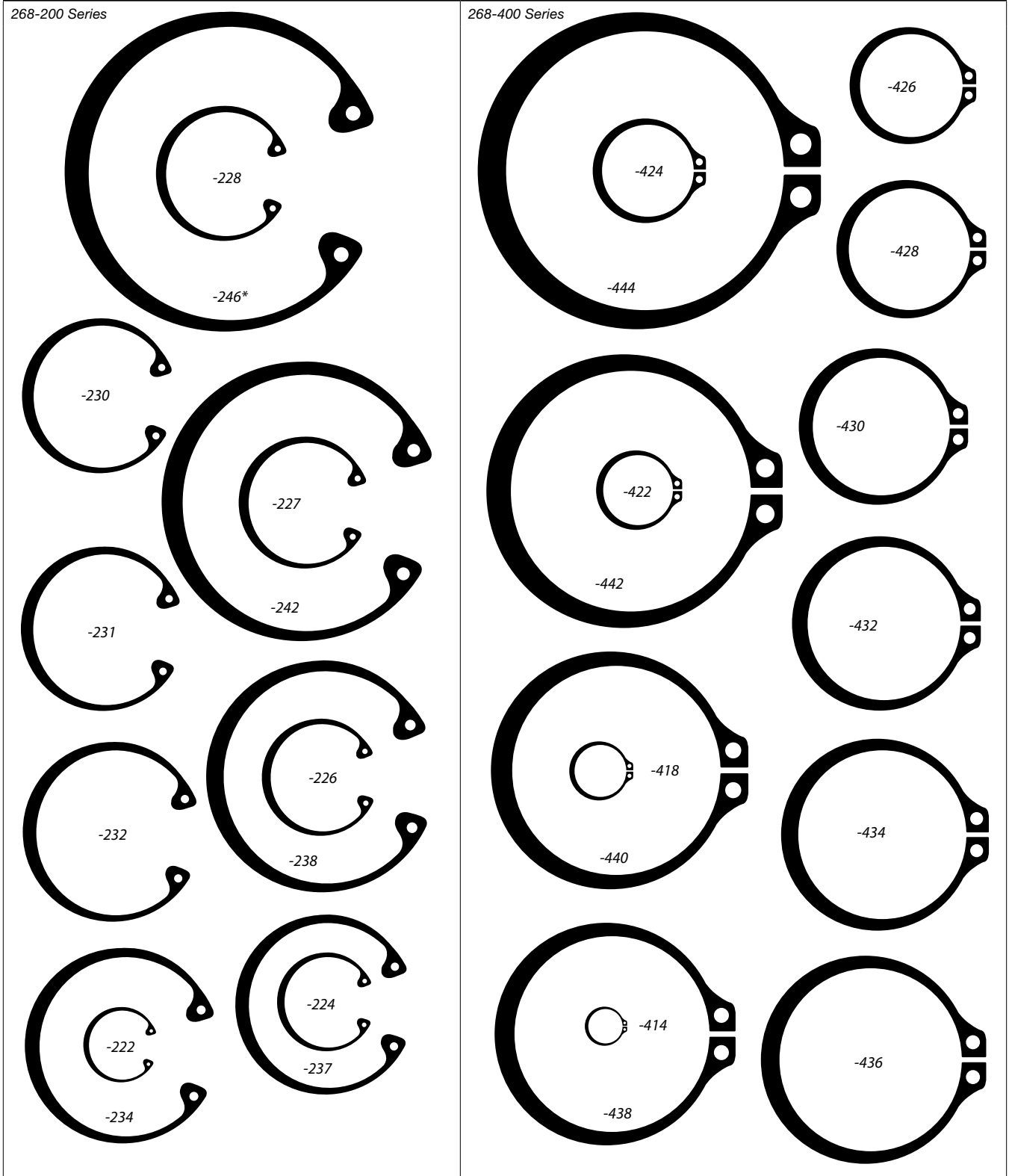





For Other sizes of Snap Rings - see next page.

**SNAP RINGS
CIRCLIPS**

**268
Series**

ORDER BY STOCK NUMBER

* Example of Stock Number: 268-522

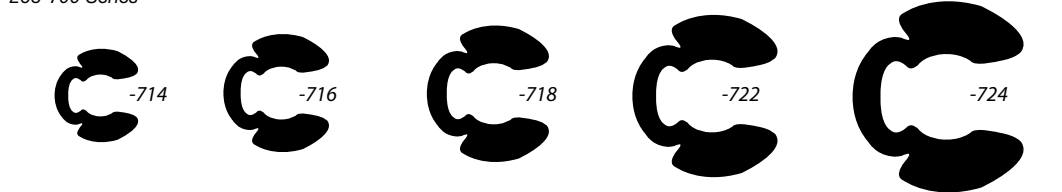
<p>268-300 Series</p>  <p>-329</p>	<p>268-500 Series</p>  <p>-505 -506 -511 -510 -514 -516 -518 -520 -522*</p>
<p>268-300 Series</p>  <p>-330</p>	<p>268-600 Series</p>  <p>-606 -610 -614 -616 -618 -620</p>
<p>268-300 Series</p>  <p>-332</p>	<p>268-700 Series</p>  <p>-714 -716 -718 -722 -724</p>

GARAGE ASSORTMENT

No. 020-041

Contains 43 External Snap Rings, 6 sizes of 268-600 Series for 5/32" through 9/16" Dia. shafts.

No. 020-042

Contains 50 Internal Snap Rings, 10 sizes of 268-200 Series for 1/2" through 2" housing diameters.

020-041





**SNAP RING PLIERS
PINCES À CIRCLIP**

**262
Series**

ORDER BY STOCK NUMBER

Individually Garded

	<p>No. 262-980 External with Tips (Black) No. 262-981 Internal with Tips (Red) No. 262-982 Snap Rings Pliers Set Economical tools for medium duty. Non-slip cushion coated grips on stamped Steel handles. Complete with four sets of tips.</p>														
	<p>No. 262-976 External with Tips (Black) No. 262-977 Internal with Tips (Red) Professional quality tools have no exposed springs to pop out or snag other tools. Non-slip cushion-coated handles make pliers easy to grip and use. Complete with four sets of tips.</p>														
	<p>No. 262-983 Precision Tips Set</p> <table border="1" data-bbox="592 1879 1429 1955"> <tr> <td>1 pair</td> <td>.045" Straight</td> <td>1 pair</td> <td>.035"</td> <td>45°</td> </tr> <tr> <td>1 pair</td> <td>.060" Straight</td> <td>1 pair</td> <td>.045"</td> <td>90°</td> </tr> </table>					1 pair	.045" Straight	1 pair	.035"	45°	1 pair	.060" Straight	1 pair	.045"	90°
1 pair	.045" Straight	1 pair	.035"	45°											
1 pair	.060" Straight	1 pair	.045"	90°											

WOODRUFF KEYS CLAVETTES 'WOODRUFF'

302
Series

Papco® Woodruff Keys are made from S.A.E. 1035 Carbon Steel. They are used on armature shafts of starters and generators, etc.

ORDER BY STOCK NUMBER

Standard Package: 25 Keys

Stock No.	Size Width x Dia.	Stock No.	Size Width x Dia.	Stock No.	Size Width x Dia.	Stock No.	Size Width x Dia.
302-010	1/16 x 1/2	302-091	1/4 x 3/4	302-170	7/32 x 1-1/8	302-236	3/8 x 1-3/8
302-020*	3/32 x 1/2	302-100*	5/32 x 7/8	302-180*	1/4 x 1-1/8	302-240	1/4 x 1-1/2
302-030*	1/8 x 1/2	302-110*	3/16 x 7/8	302-183	5/16 x 1-1/8	302-250	5/16 x 1-1/2
302-040*	3/32 x 5/8	302-120	7/32 x 7/8	302-190	3/16 x 1-1/4	302-257	3/8 x 1-1/2
302-050*	1/8 x 5/8	302-121	1/4 x 7/8	302-200	7/32 x 1-1/4	302-270	1/4 x 2-1/8
302-060*	5/32 x 5/8	302-130*	3/16 x 1	302-210	1/4 x 1-1/4	302-280	5/16 x 2-1/8
302-061	3/16 x 5/8	302-140	7/32 x 1	302-214	5/16 x 1-1/4	302-290	3/8 x 2-1/8
302-070	1/8 x 3/4	302-150*	1/4 x 1	302-215	3/8 x 1-1/4	302-291	3/8 x 2-3/4
302-080*	5/32 x 3/4	302-152	5/16 x 1	302-220	1/4 x 1-3/8	302-292	5/16 x 2-3/4
302-090*	3/16 x 3/4	302-160	3/16 x 1-1/8				

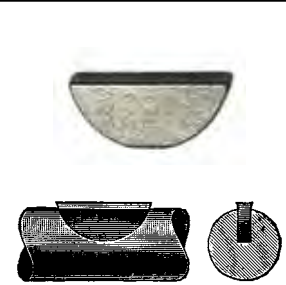

*Denotes popular sizes

Sizes not listed can be supplied.

GARAGE ASSORTMENT

No. 020-020

This assortment contains 100 Woodruff Keys in 12 sizes that are needed in every garage. Packed in a sturdy, plastic box.

020-020



GARAGE ASSORTMENT

No. 020-021

This assortment contains 29 of the following large size Woodruff Keys. 302-190, 200, 210, 214, 215, 220, 240, 250, 257, 270, 280, 290, 291, 292.

020-021



For complete coverage of most tractors and farm machinery use the 020-020 Woodruff Key Assortment together with 020-021.

MASTER ASSORTMENT

No. 020-614

- Contains 210 Woodruff Keys.
- 20 popular sizes.
- Metal merchandiser box with moulded plastic compartments.
- Actual size illustrations on lid label.
- Refills available in standard packages.
- Sizes: 302-010, 020, 030, 040, 050, 060, 070, 080, 090, 100, 110, 121, 130, 150, 152, 160, 180, 200, 210, 240.
- Size: 9-3/4" W x 13-3/4" L x 2" D.

020-614



'SUPER-SERVICE' ASSORTMENT

No. 020-820

Contains 374 Woodruff Keys - 32 sizes. Large size, rigid metal box with high-strength plastic compartments.

Size: 12" W x 18" L x 3" D.

For more details see page 10.

020-820



**UNIVERSAL 'O' - RINGS
JOINTS TORIQUES UNIVERSELS**

**304
Series**

Popular standard sizes used in automotive, agricultural and industrial equipment maintenance. Papco[®] O-Rings are made of a special Nitrile Compound (Buna-N Rubber) for petroleum oils, greases, automotive gasoline, alcohols, glycols, fuel oil, propane and many other fluids.

Assembly instructions: Be sure all parts are perfectly clean. Then lubricate the O-Ring. For an external groove, stretch the ring over the shaft or fold the ring into an internal groove. Avoid excessive twisting.

ORDER BY STOCK NUMBER

Standard Package: contains 25 'O' Rings

Stock No.	Nominal Size			Stock No.	Nominal Size		
	I.D.	O.D.	Section		I.D.	O.D.	Section
304-001	1/8	1/4	1/16	304-022	1-3/16	1-7/16	1/8
304-002	5/32	9/32	1/16	304-023	1-1/4	1-1/2	1/8
304-003	3/16	5/16	1/16	304-024	1-5/16	1-9/16	1/8
304-004	7/32	11/32	1/16	304-025	1-3/8	1-5/8	1/8
304-005	1/4	3/8	1/16	304-026	1-7/16	1-11/16	1/8
304-006	5/16	7/16	1/16	304-027	1-1/2	1-3/4	1/8
304-007	3/8	1/2	1/16	304-028	1-1/2	1-7/8	3/16
304-008	3/8	9/16	3/32	304-029	1-5/8	2	3/16
304-009	7/16	5/8	3/32	304-030	1-3/4	2-1/8	3/16
304-010	1/2	11/16	3/32	304-031	1-7/8	2-1/4	3/16
304-011	9/16	3/4	3/32	304-033	2-1/8	2-1/2	3/16
304-012	5/8	13/16	3/32	304-035	2-3/8	2-3/4	3/16
304-013	11/16	7/8	3/32	304-037	2-5/8	3	3/16
304-014	3/4	15/16	3/32				
304-015	3/4	1	1/8				
304-016	13/16	1-1/16	1/8				
304-017	7/8	1-1/8	1/8				
304-018	15/16	1-3/16	1/8				
304-019	1	1-1/4	1/8				
304-020	1-1/16	1-5/16	1/8				
304-021	1-1/8	1-3/8	1/8				

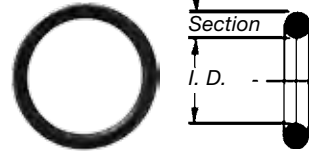

GARAGE ASSORTMENT

No. 020-072

Contains 78 rings, 15 sizes from 1/8" to 3/4" I.D. Packed in a clear plastic box.



UNIVERSAL 'O' RING ASSORTMENT

No. 020-960

Contains 382 rings, 30 sizes from 1/8" to 1-3/4" I.D. Popular assortment of inch-series. 'O' Rings packed in a durable A.B.S. plastic dispensing box with individual posts and compartments, and with a cross-section (thickness) molded gauge. Size chart is shown on cover.



MASTER ASSORTMENT

No. 020-626

Contains 300 rings, 30 sizes, in sturdy metal box with locking lid and carrying handle. Illustrated label with actual size illustrations to make correct selection easy.



'SUPER-SERVICE' ASSORTMENT

No. 020-821

Contains 390 'O' Rings - 30 sizes. Large size, rigid metal box with high-strength plastic compartments. Size: 12" W x 18" L x 3" D. For more details see page 10.

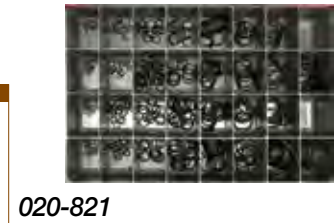

**AXLE SHAFT KEY STOCK
BARRES DE CLEF**

**313
Series**

Papco[®] Axle Key Stock in 12" lengths enables the technician to make up any size axle key on short notice and with a minimum investment. Standard package contains six 12" lengths.

ORDER BY STOCK NUMBER

Stock No.	Size	Stock No.	Size
313-174	3/16 x 3/16	313-180	1/2 x 1/2
313-176	1/4 x 1/4	313-181	1/4 x 5/16
313-177	5/16 x 5/16	313-182	1/4 x 3/8
313-178	3/8 x 3/8	313-183	5/16 x 3/8
313-179	7/16 x 7/16	313-185	3/8 x 7/16

AXLE KEY STOCK ASSORTMENT

No. 020-853

Contains 20 Lengths of Key Stock in all popular sizes. All 12" Long.



ASSORTMENT

No. 020-906

This handy assortment contains 50 lengths - 10 each of 3/16", 1/4", 5/16", 3/8" and 1/2" sq. x 12" long Axle Key Stock. Make your own keys for axle shafts, pulley shafts and many other applications where a straight key is needed. Attractive, all metal merchandiser can stand on counter or hang on wall.

020-906



AXLE KEYS BARRES DE CLEF

313
Series

Papco[®] Axle Keys are made from special S.A.E. Key Steel, supplied in various sizes to service all cars and trucks.

ORDER BY STOCK NUMBER

Standard Package: Contains 12 Axle Keys

Stock No.	Size	Stock No.	Size	Stock No.	Size	Straight Parallel Type
313-078	3/16 x 3/16 x 1	313-115	1/4 x 5/16 x 3-1/4	313-139	1/4 x 3/8 x 3-1/4	
313-105	1/4 x 1/4 x 2-7/8	313-124	5/16 x 5/16 x 2-3/4	313-144	5/16 x 3/8 x 3-3/4	
313-107	1/4 x 1/4 x 3-1/8	313-127	5/16 x 5/16 x 3-1/8	313-147	5/16 x 7/16 x 3	
313-111	1/4 x 5/16 x 2-1/2	313-136	1/4 x 3/8 x 2-5/8	313-152	3/8 x 3/8 x 3-3/4	

AXLE KEY ASSORTMENT

No. 020-862

This assortment contains 40 keys made up of the 12 sizes listed above.

020-862

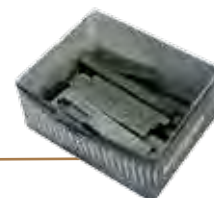

HOLE (BUTTON) PLUGS BOUCHONS DE TROU

314
Series



Used to plug holes in instrument panel, cowl, fire wall, etc. Made of Nickel Plated Steel with spring action prongs. They snap into place and can be removed and re-inserted.

ORDER BY STOCK NUMBER

Standard Package: 50 Plugs

Stock No.	Fits Hole Size	Stock No.	Fits Hole Size
314-018	3/8"	314-026	3/4"
314-020	7/16"	314-030	1"
314-022	1/2"	314-034	1-1/4"
314-024	5/8"		

For Plastic button Plugs: see page 154.

GARAGE ASSORTMENT

No. 020-028

Contains 47 hole plugs, including each of the sizes listed. Ideal for plugging aerial, accessory or switch holes. Packed in clear plastic container.

020-028



MECHANICS' WIRE BROCHE DE MÉCANICIEN

314
Series

STOVE PIPE WIRE

Papco[®] Mechanics Wire is soft annealed for general use in garage or workshop. Used as locking wire in drilled bolts in bearings and flywheels. Packed on sturdy plastic spools - saves time - eliminates waste.

ORDER BY STOCK NUMBER

Stock No.	Two Pound Spools
314-218	18 Ga. (.047) 330 ft. Per spool

Note: Length shown is approximate.

314-218



AN INTRODUCTION TO...

WHEEL PARTS

PIÈCES DE ROUE

...UNE INTRODUCTION.

www.hpaulin.com

For a full listing of Papco®
Wheel Parts and application
guide, please refer to our current
catalogue or visit our website to
download a PDF version.



WHEEL BOLTS AND NUTS

- PASSENGER CAR
- LIGHT TRUCK
- IMPERIAL
- METRIC
- HEAVY TRUCK

REAR WHEEL STUDS



**WHEEL NUTS
ÉCROUS DE ROUE**

558 Series

PASSENGER CAR/LIGHT TRUCK

559 Series

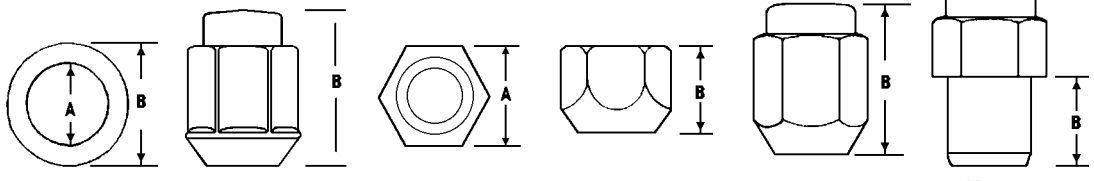

558-200 **Chrome Bulge Seat** **Across Flats Reg. Mag & Acorn** **Zinc Plated Reg. Nut** **Chrome Acorn Nut** **Chrome Mag Nut**

FINISHES
b=black
c=chrome
g=grey
s=stainless
z=zinc



A=Acorn B=Bulge C=Cover D=DometopCapped E=External Thread F=FlattopCapped H=Flanged Flat M=Mag W=Wire Wheel S=Standard

REFER TO CURRENT WHEEL PARTS CATALOGUE FOR FULL LISTING AND APPLICATION GUIDE

Part No	Diameter/Type	'A'	'B'	Type	St. Pkg.	Part No	Diameter/Type	'A'	'B'	Type	St. Pkg.
558-014	7/16-20R Reg.	3/4	9/16	Sz	25	559-089	M12 x 1.5 Flattop Capped	19mm	32mm	Fs	10
558-016	1/2-20R Reg.	13/16	5/8	Sz	25	559-095	M12 x 1.25 Mag	13/16	3/4	Mc	10
558-027	1/2-20R Reg.	3/4	9/16	Sz	25	559-100	M12 x 1.5 Mag	13/16	3/4	Mc	10
558-044	5/8-18R Reg.	1-1/16	21/32	Sz	10	559-112	M14R x 1.5	21mm	34mm	D	10
558-045	5/8-18L Reg.	1-1/16	21/32	Sz	10	559-113	M12 x 1.25 Standard	21mm	16mm	Sc	10
558-047	9/16-18R Reg.	1	11/16	Sz	10	559-114	M12 x 1.25 Acorn	21mm	29mm	Ac	10
558-050	9/16-18L Reg.	1	11/16	Sz	10	559-117	M12 x 1.5 Flanged Flat	21mm	37mm	DHc	10
558-055	5/8-18R Reg.	1	21/32	Sz	10	559-125	M12 x 1.25 Reg.	21mm	16mm	Sz	10
558-057	5/8-18R Flange	1-1/8	1-1/16	Hs	10	559-137	M12 x 1.5 Acorn Flanged	19mm	40mm	AHc	10
558-058	9/16-18R Reg.	1-1/16	21/32	Sz	10	559-138	M12 x 1.5 Acorn Flanged	19mm	35mm	AHc	10
558-061	9/16-18R Reg.	1-1/16	15/16	Sz	10	559-141	M12 x 1.5 Acorn	21mm	27mm	Ac	10
558-062	9/16-R Bulge	15/16	1-1/64	Bz	10	559-150	M12 x 1.5 Reg.	19mm	14mm	Sz	10
558-070	7/16-20 Dometop Capped	3/4	1-1/8	Ds	10	559-151	M12 x 1.5 External Thread	19mm	34mm	EHs	10
558-071	1/2-20 Dometop Capped	13/16	1-15/32	Ds	10	559-154	M14 x 1.5 Bulge	22mm	21mm	Bz	10
558-092	9/16-18R Wash. Nut	1-1/16	1	Hb	10	559-163	M12 x 1.5 Bulge	19mm	23mm	Bz	10
558-094	1/2-20 Dometop Bulge	3/4	1-39/64	DBs	10	559-167	M12-1.5 Mag	21mm	47mm	Mc	10
558-100	9/16-18R Reg.	7/8	3/4	Sz	10	559-172	M12 x 1.5 Reg.	21mm	18mm	Sz	10
558-122	1/2-20 Dometop Capped	3/4	1-5/16	Ds	10	559-174	M12 x 1.75 Flanged Flat	19mm	23mm	Hb	10
558-123	1/2-20 Dometop Capped	13/16	1-17/64	Db	10	559-181	M12 x 1.5 Wirewheel	19mm	43mm	Ws	10
558-124	1/2-20 Dometop Bulge	13/16	1-9/32	DBs	10	559-190	M12 x 1.5 Dometop Capped	19mm	36mm	Ds	5
558-127	9/16-18 Flanged Flat	7/8	1	Hb	10	559-191	M12 x 1.5 External Thread	19mm	28mm	Ez	5
558-140	7/16-20 Acorn	3/4	1-3/8	Ac	10	559-192	M12 x 1.5 External Thread	19mm	31mm	Ez	5
558-143	1/2-20 Dometop Capped	13/16	2-1/32	Ds	10	559-193	M14 x 1.5 External Thread	22mm	29mm	Ez	5
558-144	7/16-20 Acorn	13/16	1-3/8	Ac	10	559-194	M14 x 1.5 External Thread	22mm	26mm	Ez	5
558-146	1/2-20 Acorn	13/16	1-3/8	Ac	10	559-196	M14 x 2.0 Flanged Flat	21mm	23mm	Hb	10
558-148	1/2-20R Acorn Bulge	3/4	1-3/8	ABc	10	559-200	M24 x 2.0 Cover Grey	18mm	29mm	Cg	5
558-160	1/2-20 External Thread	3/4	1-3/16	Ez	5	559-201	M24 x 2.0 Cover Stainless	19mm	39mm	Cs	5
558-162	1/2-20 Bulge	13/16	59/64	Bz	5	559-202	M24 x 2.0 Cover Black	19mm	40mm	Cb	5
558-163	1/2-20 Bulge	3/4	29/32	Bz	10	559-203	M24 x 2.0 Cover Grey	19mm	44mm	Cg	5
558-171	1/2-20 Wirewheel	3/4	1-1/4	Wz	10	559-204	M24 x 2.0 Cover Black	19mm	45mm	Cb	5
558-174	7/16-20 Mag	13/16	3/4	Mc	10	559-205	M27 x 2.0 Cover Black	22mm	40mm	Cb	5
558-176	1/2-20 Mag	13/16	3/4	Mc	10	559-206	M27 x 2.0 Cover Black	23mm	40mm	Cg	5
558-197	1/2-20 Wirewheel	13/16	1-5/32	Wz	10	559-209	M24 x 2.0 Cover Black	18mm	29mm	Cb	5
558-199	1/2-20R Wirewheel	3/4	1-1/4	Wz	10	559-210	M27 x 2.0 Cover Black	21mm	39mm	Cg	5
558-200	Mag Washers	11/16	1	c	10	559-211	M24 x 2.0 Cover Grey	19mm	33mm	Cg	5
558-204	9/16-18 Dometop Bulge	7/8	1-1/2	DBc	10	559-212	M27 x 2.0 Cover Black	22mm	36mm	Cb	5
558-222	1/2-20 External Thread	13/16	1.07	Sz	5	559-215	M24 x 2.0 Cover Black	19mm	33mm	Cb	5
558-292	1/2-20 Dometop Capped	13/16	1-1/2	Ds	10	559-220	M24 x 2.0 Cover Black	19mm	33mm	Cb	5
558-296	9/16-18 Flanged Flat	15/16	1-1/8	Hb	10	559-257	M14-1.5 Bulge	21mm	24mm	Bz	10
559-060	M10 x 1.25 Acorn	17mm	21mm	Ac	10	559-259	M14-1.5 Dometop Capped	21mm	43.5mm	Dc	10
559-064	M12 x 1.25 Reg.	19mm	16mm	Sc	10	559-277	M14-1.5 Acorn	22mm	46mm	Ac	10
559-065	M12 x 1.25 Acorn	13/16	1-3/8	Ac	10	559-301	M12 x 1.5 Acorn Bulge	19mm	30mm	ABc	10
559-070	M12 x 1.5 Acorn	13/16	1-3/8	Ac	10	559-302	M14-1.5 Flanged Flat	22mm	34mm	Hb	10
559-074	M12 x 1.5 Dometop Capped	19mm	31mm	Ds	10	559-305	M12 x 1.5 Dometop Capped	20mm	30mm	Ds	10
559-075	M12 x 1.5 Acorn	3/4	1-3/8	Ac	10	559-306	M14 x 2.0 Dometop Capped	20mm	50mm	Ds	10
559-077	M12 x 1.5 Acorn Bulge	19mm	35mm	ABc	10	559-308	M12 x 1.5 Acorn	21mm	38mm	Ac	10
559-078	M12 x 1.25 Acorn	19mm	25mm	Ac	10	559-309	M12 x 1.5 Acorn	21mm	30mm	Ac	10
559-085	M12 x 1.5 Wirewheel	19mm	22mm	Wb	10	559-310	M12 x 1.25 Dometop Capped	21mm	34mm	Dc	10
559-087	M12 x 1.5 Dometop Capped	19mm	30mm	Ds	10	559-323	M14 x 2.0 Wire Wheel	21mm	31mm	Ws	10

WHEEL BOLTS BOULONS DE ROUE

560 Series

PASSENGER CAR/LIGHT TRUCK

■ Bare Metal

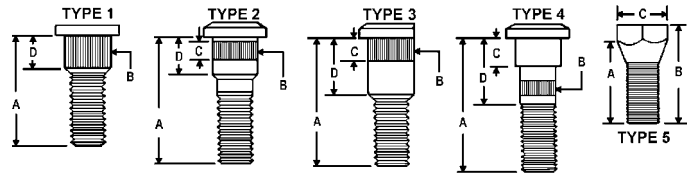

■ REFER TO CURRENT WHEEL PARTS CATALOGUE FOR FULL LISTING AND APPLICATION GUIDE

Specifications and Interchange

Standard Package 10 pcs.

Part No.	Type	Diameter x 'A'		'B'	'C'	'D'	Factory No.
560-009	5	1/2-20	R x 7/8	1-1/4	3/4 HEX	-	-
560-010	5	1/2-20	R x 1-1/8	1-1/2	3/4 HEX	-	-
560-011	5	1/2-20	R x 1-7/8	2-1/4	3/4 HEX	-	-
560-013	5	9/16-18	R x 1-7/16	1-13/16	7/8 HEX	-	-
560-014	5	9/16-18	R x 1-5/16	1-11/16	7/8 HEX	-	-
560-015	5	9/16-18	R x 1-5/8	2-1/16	7/8 HEX	-	-
560-016	5	9/16-18	R x 1-3/8	1-3/4	3/4 HEX	-	-
560-017	5	5/8-18	R x 1-9/16	2	7/8 HEX	-	-
560-018	5	1/2-20	R x 1-1/8	1-7/16	3/4 HEX	-	-
560-019	5	9/16-18	R x 1-1/4	1-9/16	3/4 HEX	-	-
560-032	1	1/2-20	R x 1-3/8	.630	-	.555	2405146
560-034	1	1/2-20	R x 1-1/2	.618	-	.312	1486230
560-039	2	1/2-20	R x 1-5/8	.620	.460	.500	2952858
560-090	2	1/2-20	R x 1-5/16	.625	.270	.438	539499
560-096	1	7/16-20	R x 1-7/16	.560	-	.530	2534754
560-102	2	1/2-20	R x 1-11/16	.562	.200	.630	3229187
560-103	2	1/2-20	R x 1-1/2	.665	.200	.590	2513744
560-105	2	1/2-20	R x 1-13/16	.560	.300	.640	3699680
560-110	4	1/2-20	R x 2	.623	.215	1.000	3736751
560-114	2	7/16-20	R x 1-1/2	.465	.140	.285	9590259/71
560-138	1	1/2-20	R x 1-5/8	.535	-	.325	1235137
560-148	2	1/2-20	R x 1-13/16	.620	.220	.780	3580693
560-155	1	1/2-20	R x 1-5/8	.630	-	.620	3961258
560-163	2	1/2-20	R x 1-7/16	.545	.270	.438	D3AZ-1107B
560-167	2	1/2-20	R x 1-15/16	.587	.220	.625	D6AZ-1107C
560-172	2	1/2-20	R x 1-7/8	.560	.300	.650	D6DZ-1107A
560-173	2	1/2-20	R x 1-3/4	.625	.280	.438	D6AZ-1107A
560-175	2	1/2-20	R x 1-3/4	.665	.312	.575	2959852
560-180	4	5/8-18	R x 2-1/16	.655	.312	.906	3496564
560-181	2	5/8-18	R x 2-13/32	.652	.255	.813	3641576
560-182	4	5/8-18	R x 2-9/16	.655	.400	.875	2515316
560-183	4	5/8-18	R x 2-15/16	.650	.420	1.000	3637878
560-186	2	1/2-20	R x 1-7/8	.612	.250	.600	EOTZ-1107C
560-187	1	1/2-20	R x 1-5/8	.623	-	.650	5357196
560-269	2	1/2-20	R x 2-1/8	.623	.200	.600	D3TZ-1107A/E
560-277	4	1/2-20	R x 2-1/4	.625	.225	.965	-
560-280	4	9/16-18	R x 2-1/8	.625	.225	.935	-
560-286	4	1/2-20	R x 2-3/16	.723	.300	1.250	4116934
560-287	2	1/2-20	R x 1-29/32	.667	.375	.725	6032505
560-289	2	1/2-20	R x 1-29/32	.583	.325	.420	6033382
560-298	2	1/2-20	R x 2	.547	.215	.687	E6TZ-1107B
560-303	2	9/16-18	R x 3-9/32	.677	.435	.725	E5TZ-1107B
560-305	2	9/16-18	R x 2-1/8	.640	.275	.562	E6TZ-1107A
560-345	2	1/2-20	R x 1-7/8	.570	.225	.625	-
560-348	4	1/2-20	R x 2-1/8	.658	-	.812	4383430
560-355	4	9/16-18	R x 2-13/16	.630	.180	1.125	D0TZ-1107A
560-356	4	9/16-18	L x 2-13/16	.630	.225	1.125	D0TZ-1119A
560-358	2	1/2-20	R x 2	.612	.340	.656	E9ZZ-1107A
560-363	4	1/2-20	R x 2-11/32	.651	.415	1.000	4030779
560-364	2	1/2-20	R x 1-15/32	.618	.210	.484	83503053
560-366	2	1/2-20	R x 1-3/4	.650	.370	.740	1229808-9
560-367	3	1/2-20	R x 2	.585	.190	.750	F1VZY-1107A
560-368	2	1/2-20	R x 1-31/32	.615	.312	.531	F0VY-1107A
560-376	2	9/16-18	R x 1-7/8	.620	.312	.700	3997956
560-386	2	7/16-20	R x 1-5/16	.555	.280	.400	9590258
560-389	2	9/16-18	R x 2-5/16	.666	-	.812	-
560-390	2	7/16-20	R x 1-1/2	.555	.300	.650	99785156
560-439	2	9/16-18	R x 2-7/16	.658	.270	.438	-
560-444	3	1/2-20	R x 2-1/16	.628	.188	.437	-
560-458	4	9/16-18	R x 2-13/32	.630	.325	.950	C9TZ-1107C
560-459	2	9/16-18	R x 2-1/8	.635	.280	.500	334388
560-460	2	9/16-18	R x 3	.630	.875	1.060	3988538
560-461	2	9/16-18	R x 3-9/16	.630	.875	1.675	355815
560-468	4	9/16-18	R x 2-1/8	.650	.300	.750	475988
560-469	4	9/16-18	R x 2-1/2	.650	.410	.925	14002236
560-470	4	1/2-20	R x 1-3/4	.625	.200	.740	2955940
560-472	2	9/16-18	R x 2	.623	.200	.585	C8TZ-1170E
560-473	4	9/16-18	R x 2-5/8	.622	.225	1.000	E0TZ-1107B
560-474	2	9/16-18	R x 2-1/2	.620	.240	.500	E4TZ-1107A
560-479	3	1/2-20	R x 2-3/32	.610	.312	.484	-
560-529	2	9/16-18	R x 2-3/8	.645	.300	.425	2C2Z1107A
560-604	4	7/16-20	R x 1-3/4	.575	.280	.860	3995841

**METRIC WHEEL BOLTS
BOULONS DE ROUE MÉTRIQUE**

**561
Series**

PASSENGER CAR/LIGHT TRUCK

■ Bare Metal

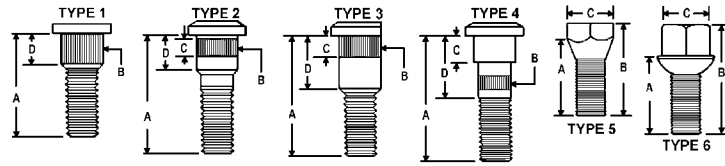

■ REFER TO CURRENT WHEEL PARTS CATALOGUE FOR FULL LISTING AND APPLICATION GUIDE

Specifications and Interchange

Standard Package 10 pcs.

Part No.	Type	Diameter x 'A'	'B'	'C'	'D'	Factory No.
561-100	2	M12 x 1.25R x 39mm	12.9mm	7mm	15.4mm	40222-A0800
561-102	2	M12 x 1.25R x 32mm	12.9mm	7mm	10.6mm	40222-2201
561-106	1	M12 x 1.5R x 38.5mm	14.7mm	-	10mm	6500352/073
561-108	2	M12 x 1.5R x 38.5mm	14.3mm	7mm	10mm	5204272
561-109	3	M12 x 1.5R x 40mm	14.8mm	7mm	13.5mm	-
561-110	2	M12 x 1.5R x 43mm	13mm	6mm	9.6mm	9590475/76
561-112	2	M12 x 1.5R x 40mm	12.5mm	8mm	10mm	94024217
561-114	1	M12 x 1.5R x 38mm	14.35mm	-	11mm	94025172
561-115	2	M12 x 1.5R x 35mm	12.7mm	5mm	9mm	-
561-118	5	M12 x 1.5R x 34mm	43mm	19mm Hex	-	3238138, D8RZ-1107B
561-122	1	M12 x 1.5R x 36mm	14.3mm	-	9mm	90942-02035
561-126	2	M12 x 1.5R x 41mm	14.2mm	5mm	8.5mm	90942-02037
561-130	6	M12 x 1.5R x 27mm	40mm	17mm Hex	-	321-601-139
561-132	6	M12 x 1.5R x 30mm	45mm	17mm Hex	-	321-601-139C
561-133	6	M14 x 1.5R x 35mm	50mm	17mm Hex	-	431/443-601-139A
561-139	2	M12 x 1.5R x 37mm	14mm	4mm	11mm	-
561-140	1	M12 x 1.5R x 37mm	14.4mm	-	6.4mm	MB057603
561-152	6	M12 x 1.5R x 30mm	48mm	19mm Hex	-	90304-692-920-921
561-154	2	M12 x 1.5R x 36mm	12mm	6.3mm	12mm	90113-SAO-003
561-155	1	M12 x 1.25R x 33mm	12mm	-	10mm	90113-634-003
561-166	1	M12 x 1.5R x 32mm	13mm	-	9mm	D5RY-1107C
561-167	6	M12 x 1.5R x 28mm	44mm	21mm Hex	-	-
561-168	2	M12 x 1.5R x 38mm	13mm	7mm	12mm	E07Z-1107A/C
561-169	2	M12 x 1.5R x 43mm	12.85mm	6.5mm	13.8mm	F0CZ-1107A
561-174	1	M12 x 1.25R x 34mm	12.24mm	-	10mm	96057612
561-175	2	M12 x 1.25R x 38mm	12.24mm	9.6mm	14mm	96057613
561-247	2	M12 x 1.5R x 46mm	13.41mm	6.5mm	11.2mm	F0DZ-1107A
561-248	2	M12 x 1.5R x 43mm	14.5mm	5.5mm	11mm	E43Z-1107A
561-249	2	M12 x 1.5R x 46mm	15.37mm	5.7mm	15mm	E9SZ-1107C
561-250	3	M12 x 1.5R x 47mm	13.34mm	6.5mm	14.3mm	E0SZ-1107A
561-251	2	M12 x 1.5R x 51mm	13.5mm	5mm	14.5mm	E3FZ-1107A
561-255	2	M12 x 1.5R x 52mm	12.9mm	13mm	26.5mm	FB05-26-113A
561-264	4	M12 x 1.5R x 52mm	14.33mm	5.5mm	25.12mm	90942-02053/044
561-309	3	M12 x 1.5R x 42.7mm	13.08mm	7mm	19.5mm	8596-33-062
561-312	2	M12 x 1.5R x 44mm	14.17mm	7mm	12mm	MB584750
561-322	1	M12 x 1.25R x 30mm	14.27mm	-	6.10mm	-
561-361	3	M12 x 1.5R x 41mm	16.50mm	5mm	13.3mm	6501268, 6501512
561-367	6	M12 x 1.5R x 36mm	52mm	17mm Hex	-	-
561-369	2	M12 x 1.5R x 46mm	15.00mm	6.6mm	18.00mm	6502311
561-370	2	M12 x 1.5R x 44mm	15.80mm	6mm	15.2mm	6502247
561-371	2	M12 x 1.5R x 43mm	17.00mm	6mm	15.00mm	6502330
561-376	3	M12 x 1.5R x 49mm	13.90mm	7.7mm	15.00mm	F3DZ-1107A
561-378	2	M12 x 1.25R x 42mm	14.35mm	7mm	13.5mm	-
561-380	2	M10 x 1.25R x 29mm	10mm	6mm	9mm	96055156
561-390	1	M12 x 1.75R x 51mm	14.73mm	-	8mm	-
561-393	2	M12 x 1.75R x 55mm	14.73mm	6mm	18mm	-
561-401	2	M12 x 1.25R x 42mm	14.43mm	6mm	14.5mm	-
561-410	2	M14 x 1.5R x 49mm	15.7mm	8mm	14.5mm	12338057
561-411	2	M14 x 1.5R x 76mm	15.7mm	23mm	27mm	15545356
561-413	2	M14 x 1.5R x 43mm	15.7mm	8.5mm	6mm	12338040
561-414	2	M14 x 1.5R x 43mm	15.7mm	8mm	16.5mm	15589423
561-415	2	M14 x 1.5R x 46mm	15.8mm	7mm	14mm	15589455
561-416	2	M12 x 1.5R x 52mm	14.8mm	8mm	15.3mm	-
561-417	4	M14 x 1.5R x 54mm	15.7mm	7mm	19mm	15589486
561-418	2	M14 x 1.5R x 91mm	15.7mm	22mm	33mm	15589493
561-424	2	M14 x 2.0R x 73mm	15.78mm	8mm	14.25mm	-
561-428	2	M14 x 1.5R x 65mm	15.7mm	7mm	17mm	-
561-431	2	M14 x 1.5R x 80mm	15.67mm	19mm	35mm	-
561-434	2	M14 x 1.5R x 58mm	16mm	6mm	18mm	-
561-436	2	M14 x 1.5R x 104mm	16mm	30mm	59mm	-
561-442	2	M14 x 2.0R x 58mm	15.5mm	4.6mm	12mm	-
561-445	1	M12 x 1.5R x 49mm	14.48mm	-	7mm	-
561-467	6	M14 x 1.5R x 36mm	50.5mm	17mm Hex	-	4D0601139A
561-492	2	M12 x 1.5R x 48.3mm	12.84mm	5.5mm	7mm	22701519
561-502	3	M14 x 1.5R x 50mm	16.02mm	-	18mm	-
561-516	6	M14 x 1.5R x 36mm	49mm	17mm Hex	-	0009904907
561-522	6	M14 x 1.5R x 41mm	54.5mm	17mm Hex	-	36136758730
561-527	1	M14 x 1.5R x 45.5mm	16.5mm	-	9mm	90113-SHJ-A01
561-532	6	M14 x 1.25R x 36mm	49mm	17mm Hex	-	36136774896

WHEEL NUTS ÉCROUS DE ROUE

558
Series

HEAVY TRUCK

■ Plated



062-526
062-524

558-028
558-029

558-034
558-035

558-032
558-033

Standard Package 10 pcs.

Part No.	Type	Size and Thread	Factory No.	Budd No.
062-526	Hex Conelok 'B'	3/4-16 Right Hand; 1-1/8 Hex.	Back Nut (H.T.)	
062-524	Hex Conelok 'B'	5/8-18 Right Hand; 1-15/16 Hex.	Back Nut (H.T.)	
558-028	Hex Bevelled	3/4-16 Right Hand; 1-1/2 Hex.	BB1120, 3729738	37888
558-029	Hex Bevelled	3/4-16 Left Hand; 1-1/2 Hex.	BB1121, 3729737	37889
558-032	In. & Out. Thd.	3/4-16 Right Hand 1-1/8-16 Right Hand	BB1132, 279672	10708
558-033	Same as above	3/4-16 Left Hand 1-1/8-16 Left Hand	BB1133, 279673	10709
558-034	Hex Bevelled	1-1/8-16 Right Hand; 1-1/2 Hex.	BB1134, 279670	37891-E
558-035	Hex Bevelled	1-1/8-16 Left Hand; 1-1/2 Hex.	BB1135, 279671	37892-E

REAR WHEEL STUDS GOUJONS DE ROUE ARRIÈRE

565
Series

■ Plated



Standard and Oversize

Stock No.	Description Thread x Thread x Length	Thread Length	Application
565-170	7/16-20 x 7/16-14 x 2	7/8 UNF 3/4 UNC	598766, Dodge
565-180	7/16-20 x 7/16-14 x 2 1/2	7/8 UNF 3/4 UNC	, Dodge
565-181	7/16-20 x 9/16-12 x 2 1/2	7/8 UNF 7/8 UNC	No. 2023789, Oversize GMC Truck
565-191	7/16-20 x 1/2-13 x 1 3/4	1 UNF 1/2 UNC	No. 352728-X Oversize
565-200	7/16-20 x 7/16-14 x 2 1/4	7/8 UNF 7/8 UNC	No. 3651377 Chevy Truck 1940-53
565-201	7/16-20 x 1/2-13 x 2 1/4	7/8 UNF 7/8 UNC	No. 3651377-X Oversize
565-210	5/8-11 x 5/8-11 x 2 3/4	1 1/2 UNC 1 UNC	Universal Truck Stud, Dayton Wheels
565-240	1/2-20 x 1/2-13 x 2 1/2	1UNF 3/4 UNC	55564H International
565-250	1/2-20 x 9/16-12 x 2 3/8	7/8 UNF 7/8 UNC	No. 10375VA, Oversize International
565-270	1/2-20 x 1/2-13 x 2 7/8	7/8 UNF 3/4 UNC	No. 5846703 GM Mack 18AX405 Models B-60, B-61, M-35
565-337	3/4-10 x 3/4-10 x 2 13/16	1 1/2 UNC 1 UNC	Universal Truck Stud. Dayton Wheels
565-487	7/16-20 x 11/16 x 7/16	Hex Nut	No. 351025, use with both 565-190 & 565-191 Studs
565-488	5/8-11 x 1 1/16 x 39/64	Hex Nut	Use with 565-210 Stud
565-489	3/4-10 x 1 1/4 x 47/64	Hex Nut	Use with 565-337 Stud
565-497	7/16 Dowell Washer	(Sleeve) .740 O.D.	No. BB-1142B, use with both 565-190 & 565-191 Studs

WHEEL BOLTS AND NUTS BOULOUS ET GOUJONS DE ROUE

565
Series

HEAVY TRUCK

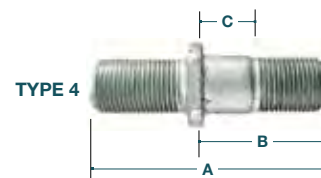

TYPE 4

Standard Package 10 Pcs.

Stock No.	Type	Thread Diameter	DIMENSIONS			CROSS REFERENCE		
			A	B	C	BUDD	FORD	G.M.
565-044	4	3/4-16	3-27/32	2-5/16	1-5/32	13990	TUAA-1118	244626
565-045						1399-L	TUAA-1119-L	244627-L
565-046	4	3/4-16	4-7/32	2-11/16	1-7/16	17123		2022806
565-047						17124-L		2022807
565-066	4	3/4-16	4-17/32	3"	1-15/16	16271		
565-068	4	3/4-16	4-1/32	2-1/2	1-9/32	19004		
565-069						19005-L		

**WHEEL BOLT AND NUT ASSORTMENTS
ASSORTIMENTS DE BOULONS ET
ÉCROUS DE ROUE**

MERCHANDISER

No. 022-055

Papco[®] Mega-Paks' are uniformly priced packages of the most popular inch & metric Wheel Bolts and Nuts. Each 'Mega-Pak' features an illustrated, colour coded label, suggested selling price and a double strength drawer box. 'Papco' 'Mega-Paks' are available individually or in a factory prepared Merchandiser No. 022-055 containing 35 sizes of the fastest selling sizes of GM, Ford, Chrysler and Import Wheel Parts.

- Sturdy, Heavy Gauge, Reinforced Steel Cabinet
- Use on Works Bench or Hang on Wall
- Colourful-Durable-Efficient
- Includes handy Bolt measuring Gauge



022-055

18-1/2" wide
14-3/4" high

Part No	Cat. No.	Pcs.	Part No	Cat. No.	Pcs.	Part No.	Cat. No.	Pcs.	Part No.	Cat. No.	Pcs.
025-712	(560-172)	2	025-874	(559-074)	1	025-915	(561-115)	2	025-963	(559-163)	3
025-715	(559-150)	4	025-875	(559-075)	4	025-916	(561-168)	2	025-964	(559-064)	3
025-738	(560-138)	3	025-891	(559-191)	2	025-925	(559-125)	4	025-967	(560-367)	2
025-748	(558-148)	3	025-892	(559-192)	2	025-926	(561-126)	2	025-968	(560-368)	2
025-750	(561-250)	2	025-900	(558-100)	3	025-935	(560-355)	2	025-969	(561-169)	2
025-755	(560-155)	4	025-903	(560-103)	3	025-938	(559-138)	1	025-976	(561-376)	2
025-772	(559-172)	3	025-908	(561-108)	3	025-946	(561-416)	1	025-978	(561-378)	2
025-773	(560-173)	2	025-909	(561-109)	3	025-954	(561-154)	3	025-996	(561-369)	2
025-816	(558-016)	5	025-910	(561-110)	3	025-962	(561-126)	2			

UTILITY ASSORTMENT

No. 020-311

This Utility Assortment contains 8 sizes of the fastest moving Papco[®] Wheel Nuts.

CONTENTS OF ASSORTMENT No. 020-311

Part No.	Pcs.	Part No.	Pcs.	Part No.	Pcs.
558-014	5	558-044	5	559-125	5
558-016	5	558-047	5	559-150	5
558-027	5	558-100	5		

MASTER ASSORTMENT

No. 020-658

A Master Assortment containing 20 sizes of the most popular Wheel Bolts and Nuts for GM, Ford, Chrysler, AMC and Imports.

CONTENTS OF ASSORTMENT No. 020-658

Part No.	Pcs.	Part No.	Pcs.	Part No.	Pcs.
560-103	5	560-173	5	561-248	5
560-114	5	560-386	5	561-251	5
560-138	5	561-108	5	558-014	10
560-148	5	561-109	5	558-016	10
560-155	5	561-110	10	558-027	10
560-167	5	561-122	5	559-150	10
560-172	5	561-154	5		

SUPER-SERVICE ASSORTMENT

No. 020-802

A 'Super-Service' Assortment containing 32 of the most popular Wheel Bolts and Nuts for GM, Ford, Chrysler, AMC and Imports.

CONTENTS OF ASSORTMENT No. 020-802

Part No.	Pcs.	Part No.	Pcs.	Part No.	Pcs.
560-102	5	560-186	5	561-167	5
560-103	5	560-386	5	561-248	5
560-105	5	561-100	5	561-251	5
560-110	5	561-102	5	561-380	5
560-114	5	561-106	5	558-014	10
560-138	5	561-108	5	558-016	10
560-148	5	561-109	5	558-027	10
560-155	5	561-110	5	559-125	10
560-167	5	561-122	5	559-150	10
560-172	5	561-154	5		
560-173	5	561-166	5		

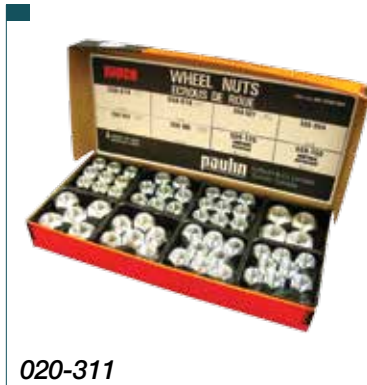

020-311



020-658



020-802

ELECTRICAL

ÉLECTRICITÉ



WIRING TERMINALS

INSULATING P.V.C. TAPE

CRIMPING TOOL

CABLE TIES

WIRE GROMMETS

FUSE ACCESSORIES

SHRINK TUBING

CIRCUIT TESTERS

TEST CLIPS

CHARGING CLIPS

TEST LEADS

BATTERY TERMINALS

BATTERY BOOSTER CLAMPS

**BATTERY BOOSTER AND
TERMINAL CLEANERS**

BATTERY HOLD DOWN BOLTS

**UNIVERSAL BATTERY
HOLD DOWNS**

**BATTERY TERMINAL
BOLTS AND NUTS**

WIRING TERMINALS COSSE SANS SOUDRE

569
Series

INSULATED SOLDERLESS TYPE

Papco® Wiring Terminals are constructed from pure electrolytic copper, annealed and electro-tin plated. The one-piece construction provides a terminal of maximum strength and electrical conductivity. The electro-tin plating affords maximum protection against corrosion. Funnel barrel entry assures easy wire insertion and a positive, solid crimp. Insulation is colour coded for the appropriate wire gauge: Red 22-18, Blue 18-14 and Yellow 12-10.

Stock No.	Type	Stud Size	Pcs/Box	Stock No.	Type	Stud Size	Pcs/Box	Stock No.	Type	Stud Size	Pcs/Box
22-18 WIRE GAUGE				18-14 WIRE GAUGE				18-14 WIRE GAUGE			
569-415	Ring	No. 4 - No. 6	50	569-465	Hook	No. 8 - No. 10	50	569-525	8-478 Recep.	-	25
569-420	Ring	No. 8 - No. 10	50	569-466	Spade	No. 4 - No. 6	50	12-10 WIRE GAUGE			
569-421	Ring	No. 12 - No. 14	50	569-467	Spade	No. 8 - No. 10	50	569-511	Ring	No. 8 - No. 10	50
569-422	Multi Fit	No. 6 - No. 10	50	569-468	"Snap" Spade	No. 8	50	569-512	Ring	No. 12 - No. 14	50
569-424	Hook	No. 8 - No. 10	50	569-469	"Snap" Spade	No. 10	50	569-513	Ring	5/16 - 3/8	50
569-425	Spade	No. 4 - No. 6	50	569-470	Three Way	-	25	569-531	Multi Fit	No. 6 - No. 10	25
569-426	Spade	No. 8 - No. 10	50					569-516	Spade	No. 8 - No. 10	50
569-432	Butt	-	50	569-473	Butt	-	50	569-522	Butt	-	50
569-435	Insul. Quick Disc.	1/4 F	25	569-474	Quick Disc.	1/4 F	50	569-523	Insul. Quick Disc.	1/4 F	25
569-436	Insul. Quick Disc.	1/4 M	25	569-475	Quick Disc.	1/4 M	50	569-524	Insul. Quick Disc.	1/4 M	25
18-14 WIRE GAUGE				569-476	Insul. Quick Disc.	1/4 F	25	569-529	Closed end	-	50
569-460	Ring	No. 4 - No. 6	50	569-477	Insul. Quick Disc.	1/4 M	25	<p>T-Tap Connectors Use in trunk to trailer hook-ups. T-splice stop lights and turn signals without stripping wires. Snap plug allows easy disconnect.</p>			
569-461	Ring	No. 8 - No. 10	50	569-478	Bullet	-	50				
569-462	Ring	No. 12 - 1/4	50	569-500	SPEE-DEE Connectors Make safe, fast, dependable connections. No wire stripping - no cutting - works on 14-18 wire gauge. Use standard pliers. The snap cover gives a completely insulated connection. Polypropylene case maintains live action.	25 Pieces					
569-464	Multi Fit	No. 6 - No. 10	50								
								569-530	25 Pieces		
								<p>For other assortments of Papco® Wiring Terminals and Crimping Tools see next page.</p>			

INSULATING PVC COLD WEATHER TAPE RUBAN BASSE TEMPÉRATURE-FROIDE

Temperature rating: -18°C to 90°C

ORDER BY STOCK NUMBER Standard Package: 10 Rolls

Stock No.	Size	Length per Roll	Colour
121-125	8mil x 3/4	66 feet	Black



Used for protecting electrical parts and wires. These tapes provide required insulation capacity, high voltage and many more.

- CSA approved
- High Quality
- Colour: Black
- Flame retardant

INSULATING P.V.C. TAPE RUBAN ISOLANTE EN P.V.C.

Temperature rating: -7°C to 80°C

ORDER BY STOCK NUMBER Standard Package: 10 Rolls

Stock No.	Size	Length per Roll	Colour
121-126	7mil x 3/4	66 feet	Black
121-127	7mil x 3/4	66 feet	Blue
121-128	7mil x 3/4	66 feet	Red
121-129	7mil x 3/4	66 feet	Yellow
121-130	7mil x 3/4	66 feet	Green
121-131	7mil x 3/4	66 feet	White



WIRING TERMINAL ASSORTMENTS ASSORTIMENTS DE BORNES ÉLECTRIQUES

GARAGE ASSORTMENT

No. 020-067

Contains 45 Ring, Spade, Multi-Fit and Butt Terminals. 15 sizes packed in a rigid, transparent plastic box.

020-067



020-650

MASTER ASSORTMENT

No. 020-650

This assortment contains 32 items for a total of 325 pieces of the most popular Ring, Spade, Hook, Butt and Quick Disconnect Terminals. Metal box with moulded plastic compartments features grease resistant lid label with actual size illustrations a handy wire size and stud size chart.

Size: 9-3/4" W x 13-3/4" L x 2" D.

SUPER SERVICE ASSORTMENT

No. 020-812

Contains 500 Wiring Terminals - complete coverage of all sizes listed. Large size, rigid metal box with high-strength plastic compartments.

Size: 12" W x 18" L x 3" D.

For more details see page 10.

020-812



**CRIMPING TOOL
OUTIL COSSE**

**569
Series**

No. 569-300

Five in one Papco[®] Crimping Tool is capable of performing five operations: Crimper (both insulated and non-insulated), Wire Cutter, Wire Stripper and Bolt Cutter. Individually carded.

Order by card number.



**CABLE TIES
SANGLES POUR CABLE**



Self-locking nylon ties for quick, simple bundling and mounting. Material is High-Strength Black Nylon 6/6 for increased resistance to outdoor exposure and ultra-violet light. Use to secure wiring harness, cables, hose, wires and pipes, and to prevent damage from moving parts or hot engine components. Packed in handy, sealed poly-bags in quantities shown.



ORDER BY STOCK NUMBER

Stock No.	Bundle Dia.	Length	Tensile Strength	Std. Pkg.
Standard Ties				
569-701	3/4"	4"	18 lbs.	100
569-704	1-1/4"	5-1/2"	40 lbs.	100
569-706	2"	8"	50 lbs.	100
569-708	4"	14-1/2"	50 lbs.	10
569-710	4"	14-1/2"	120 lbs.	10
Mounting Ties				
569-714	2"	8"	50 lbs.	25

569-701

**WIRE GROMMETS
BAGUES POUR FIL**

OIL RESISTANT BLACK VINYL

Prevents insulation damage, shorts and leaks.

ORDER BY STOCK NUMBER

Standard Package: 10 Pieces

Stock No.	Size	Stock No.	Size
569-230	3/8 O.D. x 1/4 I.D.	569-236	1/2 O.D. x 3/8 I.D.
569-231	7/16 O.D. x 5/16 I.D.	569-237	5/8 O.D. x 3/8 I.D.
569-232	1/4 O.D. x 1/8 I.D.	569-238	5/8 O.D. x 1/2 I.D.
569-233	5/16 O.D. x 3/16 I.D.	569-240	7/8 O.D. x 5/8 I.D.
569-234	3/8 O.D. x 1/4 I.D.	569-241	1" O.D. x 11/16 I.D.



**FUSE ACCESSORIES
ACCESORIES POUR FUSIBLE**

ORDER BY STOCK NUMBER

Standard Package: 5 Pieces

Stock No.	Description
569-029	In-line Fuse Holder with 10 AMP Fuse, 12 Ga. wire.
569-030	Blade (ATO) Type Fuse Holder for 3 to 20 AMP Fuses.



SHRINK TUBING TUBE RETRAIT

Insulates, groups and weather proofs wiring connections.
Charcoal grey tubing can be cut easily to suit length required.
Shrink with warm air blower.

ORDER BY STOCK NUMBER

Stock No.	Size	Standard Package
Standard Ties		
569-200	3/16 I.D. x 3"	25
569-201	1/4 I.D. x 3"	25
569-203	3/8 I.D. x 3"	25



CIRCUIT TESTERS VÉRIFICATEUR DE CIRCUIT

Tests for voltage presence in circuits. Locates improper connections, shorts and broken wires.

6-12 VOLTS CIRCUIT TESTER

No. 570-100

The most popular and largest selling tester.
Quickly and accurately tests all 6 to 12V systems.
Includes a spare bulb and extra long 48" lead.
Individually carded.



570-100

HI-LO VOLTAGE CIRCUIT TESTER

No. 570-101

All the proven features of the popular Part No. 570-100 Circuit Tester - plus the ability to test Hi-Voltage circuits such as Spark Plugs.
Checks for broken insulators, excessive gap, poor wire, fouled or worn spark plugs.



570-101

LED DISPLAY AUTO CIRCUIT TEST

No. 570-103

Professional quality Hi-Lo Voltage Circuit Tester accurately and quickly tests live wires, batteries and ignition systems including Spark Plugs. LED Display on side of tester indicates degree of battery charge.
Individually carded.



570-103

6, 12, 24 VOLTS CIRCUIT TESTER

No. 570-105

Professional quality tester features unbreakable plastic handle, heavy duty ground clip, 60" long rubber coated, heavy duty lead wire. Tests all 6, 12 and 24 Volts systems with power on. Individually carded.



570-105

**TEST CLIPS
PINCES DE VÉRIFIER**

**570
Series**

ALLIGATOR TYPE

A handy clip used in test work on ignition, radio and electrical applications. Strong, slim jaws with nesting teeth for good contact. Bright plated steel - 2" long - 3/8" jaw spread. Order by stock number 570-129. Standard package 10 clips.

570-129



CARD

No. 570-139

Convenient skin-packed card contains four Alligator Type Test Clips. Order by card number.



570-139

ASSORTMENT DISPLAY

No. 020-879

Contains 36 Alligator Type Test Clips No. 570-129. Attractive three colour point of purchase display card. See page 11.

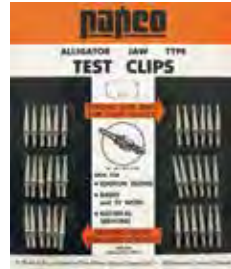

570-139

**CHARGING CLIPS
PINCES DE CHARGE**

ORDER BY STOCK NUMBER

Standard Package: 10 Clips

Stock No.	Size	Capacity	Jaw Spread	Length
570-130	Small	10 AMP	1/2"	2"
570-131	Medium	20 AMP	1"	2-7/8"
570-134	Large	50 AMP	1-1/4"	4"

- 'Bull-dog' teeth for positive contact.
- Heavily plated to resist corrosion.
- Feed-thru neck prevents twisting.
- Oversize screw head for easier wiring.



570-131

Convenient skin-packed card contains four Charging Clips. Three sizes available. Order by card number.

ORDER BY STOCK NUMBER

Card No.	Capacity
570-140	10 AMP
570-141	30 AMP
570-144	50 AMP

570-140



**TEST LEADS
FILS DE VÉRIFIER**

CARD

No. 570-110

Electrical test leads for auto, marine, hobby, shop, household and many other applications. Quickly shows hidden trouble in electrical systems. Consists of one black and one red extra long 48" leads complete with insulated, plated steel alligator clips fitted to both ends. Individually packaged.

570-110



**BATTERY TERMINAL AND GEAR PULLER
ARRACHE-COSSES/PIGNON**

CARD

No. 570-260

Use this popular tool to raise the Terminal off the post. A few turns applies even pressure without risk of damage. Individually carded.



570-260

BATTERY TERMINALS COSSES DE BATTERIE

570
Series

All Papco[®] Battery Terminals are made of Lead Alloy or Brass.

ORDER BY STOCK NUMBER

Standard Package: 25 Terminals

Stock No. 570-346	Stock No. 570-366	Stock No. 570-376	Stock No. 570-395
UNIVERSAL SIDE MOUNT TERMINAL  No. 00 down to No. 6 gauge	BRASS MARINE TERMINALS <ul style="list-style-type: none"> • Polarity specific - meets U.S. Coast Guard regulations • Brass construction, fasteners included  Standard Package: 10 positive; 10 negative No. 00 down to No. 6 gauge	UNIVERSAL STRAIGHT TYPE TERMINAL  No. 0 and 1	UNIVERSAL TERMINAL  No. 00 down to No. 6 gauge

UNIVERSAL BATTERY TERMINAL COSSE DE BATTERIE UNIVERSEL

SOLDERLESS TYPE



020-870

ASSORTMENT DISPLAY

No. 020-870

Contains 10 Universal Solderless Battery Terminals No. 570-395 (see above). Attractive three colour display card.

CARD

No. 570-396

Universal Solderless Battery Terminal holds No. 00 down to No. 6 gauge. Top plate reverses - holds flat strap or smaller wire. Fits positive or negative posts.



570-396

UNIVERSAL MARINE BATTERY TERMINAL COSSE DE BATTERIE TYPE MARIN UNIVERSEL

SOLDERLESS TYPE



020-868

ASSORTMENT DISPLAY

No. 020-868

Contains 10 Universal Marine Type Battery Terminals No. 570-366 (see above). Attractive three colour display card.

5 positive posts
5 negative posts

CARD

No. 570-397

Universal Marine Type Battery Terminal holds No. 00 down to No. 6 gauge. Forged Brass for high conductivity. Heavily plated. Fits positive or negative posts.

1 positive post
1 negative post



570-397

UNIVERSAL SIDE TERMINAL COSSE DE BATTERIE LATERAL UNIVERSEL

SOLDERLESS TYPE



020-869

ASSORTMENT DISPLAY

No. 020-869

Contains 8 Universal Side Terminals No. 570-346 (see above). Attractive three colour point of purchase display card.

CARD

No. 570-398

Universal Side Terminals fits both positive and negative posts. Convenient skin-packed card contains two terminals. Order by card number.



570-398

**BATTERY TERMINAL PROTECTORS
PROTECTEURS DE COSSE DE BATTERIE**

**570
Series**

Special polyester pad impregnated with a chemical corrosion inhibitor that prevents power robbing corrosion build-up. Extends life of terminals and hold downs. Easily installed.
25 Red and 25 Black per jar.

ORDER BY STOCK NUMBER

Card No.	Application
570-427	Post and side mount in one.

Side Terminal

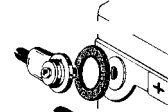

Post Terminal



570-427

**BATTERY BOOSTER CLAMPS
COLLIERS DE CHARGE-BATTERIE**



020-889

500 AMP

ASSORTMENT DISPLAY

No. 020-889

Five pair 500 AMP Professional Duty clamps with vinyl insulated, non-slip handles on attractive three colour point of purchase display card.

CARD

No. 570-245

500 AMP Professional Duty clamp made of heavy gauge steel, bright nickel plated complete with cable lug. Colour coded vinyl, non-slip insulated handles. Convenient skin-packed card contains two clamps - one red, one black. Order by card number.



570-245

**BATTERY TESTER AND BOOSTER ADAPTORS
VÉRIFICATEUR ET COLLIERS DE CHARGE-BATTERIE**



570-250

BATTERY TESTER

No. 570-250

Tests all 6,12 and 24 Volt Batteries. Accurately and quickly indicates the degree of charge in each cell. Individually blister-packed. Order by part number 570-250.

BATTERY BOOSTER ADAPTORS

No. 570-200

Made of copper plated heavy duty steel for maximum conductivity. For use on all side terminal batteries. Installs between the terminal and the battery. Makes an ideal charging connection for hard-to-reach and hard-to-grip side mount terminals.

For Side Terminals



570-200

**UNIVERSAL BATTERY AND CHARGING POST
PILE UNIVERSELLE POSTE DE CHARGEMENT**

No. 570-344

Use two ways:

- (1) As Charging Post - just screw into side mount battery and attach booster clamps.
 - (2) As Battery Post - screw into side mount battery and it becomes a post - attach conventional terminals.
- Convenient skin-packed card contains 2 complete charging post.

For Side Mount Batteries



570-344
500 AMP

BATTERY POST AND TERMINAL CLEANERS NETTOIE-BORNES / COSSES

**570
Series**

No. 570-270

This tool quickly removes corrosion and scale from the terminal. Wire brush in base cleans the battery post. Helps maintain metal-to-metal contact. Individually Carded.

Order by card number.



570-270

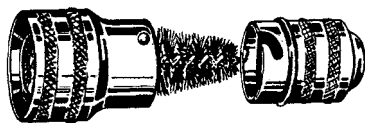

No. 570-275

Professional type, heavy duty one piece tool. Quickly and easily removes corrosion and dirt build-up that causes grounding on battery posts and terminals. Specially designed and clearly marked for cleaning either positive or negative posts. Tapered reamer for cleaning all post type battery terminals.



570-275

BATTERY HOLD DOWN BOLTS BOULONS DE FIXE-BATTERIE

All Bolts are plated and include Wing Nut and Washer. Convenient skin-packed cards contain two complete Bolts.



Type 1

Type 2

Type 3

Type 4

Card No.	Type	Size	Description	Thread	Application	Factory No.
570-610	2	1/4-20 x 10-1/2	Round Hook	4"	Universal	3688699
570-611	2	1/4-20 x 10	Round Hook	4"	Universal	
570-612	1	5/16-18 x 12	Carriage Head	5-1/2"	Universal	
570-613	2	5/16-18 x 12	Round Hook	5"	Universal	
570-614	3	1/4-20 x 10-1/4	Right Angle	4"	Universal	
570-615	2	5/16-18 x 7-1/2	Round Hook	4"	G.M. Products	
570-616	4	3/8-16 x 6	Flat End with 2 mount screws	2-1/4"	Chrysler Products (Outer bolt)	

MASTER ASSORTMENT

No. 020-628

Garages - Service Stations - can replace any Battery Hold Down Bolt with the complete coverage of this assortment.

- Contains 34 Bolts, 130 pieces. 7 sizes complete with nuts and washers.
- All metal box - hinged lid.
- Handy carrying handle with safety snap lock.
- Illustrated label shows every part.



020-628

**UNIVERSAL BATTERY HOLD DOWNS
FIXE - BATTERIE UNIVERSEL**

**570
Series**

These four styles fit most popular batteries. Made of vinyl coated steel or nylon, highly resistant to rust and corrosion. Individually skin-packed* on an attractive three colour display card. Contains all necessary hardware.

ORDER BY STOCK NUMBER

**UNIVERSAL CROSS
BAR TYPE**

No. 570-508

Universal cross bar type fits battery groups 22F, 24, 27, 60.

UNIVERSAL END TYPE

No. 570-509

Universal end type for base mount battery groups 22NF, 27F and 29NF.

UNIVERSAL SIDE TYPE

No. 570-510

Universal side type for side mount battery groups 22F and 24C also end mount group 22F.

**UNIVERSAL BATTERY
HOLD DOWN CLAMPS**

No. 570-512*

Contains two Universal Battery Hold Down clamps. Holds all types of batteries securely. Strong, flexible nylon will not break or corrode.

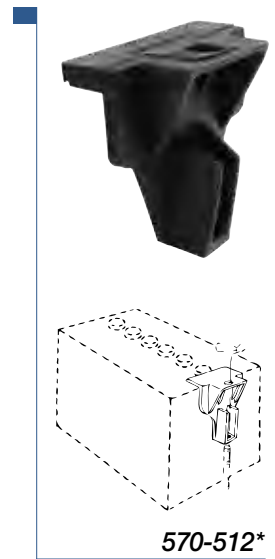
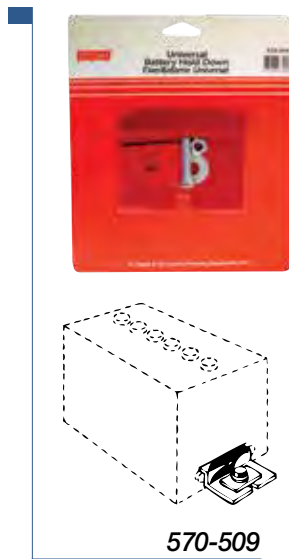
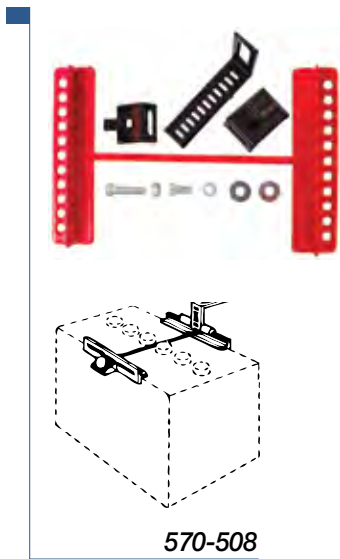

*2 per card.

**BATTERY TERMINAL BOLTS AND NUTS
BOULONS ET ÉCROUS POUR COSSE DE BATTERIE**

ORDER BY STOCK NUMBER Standard Package: 100 Pieces

**SHOULDER
BOLT and HEX NUT**

No. 570-410

5/16 x 1-1/4

NUT

No. 570-411

5/16-18

**SHOULDER
BOLT and NUT**

No. 570-412

5/16 x 1-1/4

SHOULDER NUT

No. 570-413

5/16-18

SIDE TERMINAL BOLT

No. 570-415

3/8 x 7/16



MISCELLANEOUS AUTO

PIÈCES AUTOMOBILES VARIÉES

STABILIZERS

ADJUSTABLE COIL SPRING
EXPANDER

SPRING CENTRE BOLTS & NUTS

UNIVERSAL TAILPIPE BRACKETS

CYLINDER HEAD BOLT KITS

PIPE PLUGS

WING NUT & HOOD PROP CLIP

THROTTLE ROD CLIPS & RETAINERS

THROTTLE BALL JOINTS

DRAIN COCKS

DRUM FAUCET

STUDS & NUTS

THICKNESS GAUGES

CALIPER

ANTI-FREEZE TESTER

CLAMPS

PUSH-PULL CONTROLS

UTILITY SPRINGS

VERNIER CONTROL, HEAVY DUTY

CHOKE CONVERSION KITS

UNIVERSAL SPEEDOMETER
CABLE KIT

CONTROL WIRE STOPS

CARBURETOR & THROTTLE RETURN SPRINGS

SHIM STOCKS

SNAP FASTENERS

'LIFT-THE-DOT' FASTENERS

TURN FASTENERS

GROMMETS

MAGNETS

VACUUM CONNECTORS

TAPS & DIES

THREAD CUTTING TOOLS

DRILL SETS

SOLID RUBBER, BLOCK TYPE STABILIZERS
STABILISATEURS EN CAOUTCHOUC SOLIDE

251
Series

- Corrects sagging of coil springs, bottoming and side sway.
- Convenient skin-packed card contains four stabilizers.

No. 251-031

For front coils only



251-031

Order by Card Number

No. 251-057

For rear coils only



251-057

Order by Card Number

Complete installation instructions on back of each card.

HEAVY DUTY RUBBER STABILIZERS
STABILISATEURS EN CAOUTCHOUC CHARGES ROBUSTES

- Recommended for rough road conditions and heavy duty applications such as taxis and police cars, etc.



251-059

Order by Card Number

ADJUSTABLE COIL SPRING EXPANDER
RELEVEURS DE RESSORT RÈGLABLE

251
Series

- Expands sagging coil springs for improved riding and steering qualities.
- Convenient skin-packed card contains two expanders and complete installation instructions.



Order by
Card Number

Coil Spring Expander

No. 020-882

Contains 12 Spring Expanders.

Mounted on an attractive three colour point of purchase display card.

Can be hung or set on counter.

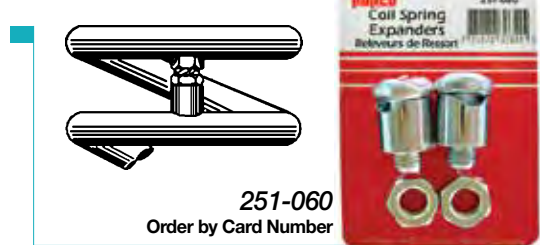

251-060

Order by Card Number

SPRING CENTRE BOLTS WITH NUTS BOULONS DE CENTRAGE DE RESSORT AVEC ÉCROUS

251 Series

Papco® Spring Centre Bolts are made of grade 2 steel, and are furnished with extra long threads in order to make them universal.

- Fillister head, Universal (long) Fine Threads with Hexagon Nut for all makes of Cars and Trucks (except Ford)



251-123

Black Finish

Order by Card Numbers

Standard Package 25 Bolts and Nuts

Stock No.	Diameter x Length	Thread Lgth.	Bulk Qty.	Stock No.	Diameter x Length	Thread Lgth.	Bulk Qty.
251-110	5/16 x 3-1/2	3	500	251-131	7/16 x 4-1/2	3	225
251-112	5/16 x 5	4	350	251-132	7/16 x 5	3	225
251-114	5/16 x 7	3	250	251-133	7/16 x 6	3	175
251-116	3/8 x 2	2	700	251-134	7/16 x 7	3	150
251-117	3/8 x 2-1/2	2	500	251-135	7/16 x 8	5	150
251-118	3/8 x 3	2-1/2	400	251-136	7/16 x 9	5	150
251-119	3/8 x 3-1/2	2-1/2	325	251-137	7/16 x 10	5	150
251-121	3/8 x 4	3	300	251-138	7/16 x 12	5	125
251-122	3/8 x 5	3	250	251-140	1/2 x 4	3	175
251-123	3/8 x 6	3	200	251-141	1/2 x 4-1/2	4	150
251-124	3/8 x 7	3	200	251-142	1/2 x 5	4	125
251-125	3/8 x 8	5	200	251-143	1/2 x 6	4	125
251-126	3/8 x 9	5	200	251-144	1/2 x 7	4	100
251-127	3/8 x 10	5	180	251-145	1/2 x 8	4	100
251-128	3/8 x 12	5	150	251-146	1/2 x 9	4	120
251-129	7/16 x 3	2	300	251-147	1/2 x 10	4	120
251-130	7/16 x 4	3	250	251-148	1/2 x 12	4	120

Note: Bulk is supplied without nuts.

DOUBLE THICKNESS NUTS ÉCROUS TRÈS HAUT

102 Series

Papco® Double Nuts are used on spring centre bolts, spring 'U' bolts, heavy duty truck wheels, tractor and implement bolts. All double thickness Nuts have UNF (S.A.E.) Fine Threads.

Light High Nuts



* 12 Pieces

Order by Card Number

Standard Package 24 pieces

Stock No.	Size	Height	Width	Stock No.	Size	Height	Width
102-018	3/8-24	.491 - .509	.551 - .562	102-027	3/4-16	.985 - 1.015	1.088 - 1.125
102-020	7/16-20	.599 - .619	.675 - .688	*102-028	7/8-14	.1140 - 1.172	1.269 - 1.312
102-022	1/2-20	.645 - .667	.736 - .750	*102-030	1-1/4	1.294 - .1330	1.450 - 1.500
102-023	9-16-18	.754 - .778	.861 - .875	*102-034	1-1/4-12	1.666 - 1.710	1.812 - 1.875
102-024	5/8-18	.831 - .857	.922 - .938				

POZI-LOK® DOUBLE NUTS ÉCROUS TRÈS HAUT POZI-LOK®

111 Series

These Nylon Insert, prevailing torque lock nuts offer excellent vibration resistance and assure positive locking under severe shock. Used for Spring Centre Bolts, Spring U-Bolts etc. UNF Fine Thread.

Order by Card Numbers

Standard Package 5 pieces

Stock No.	Size	Dimensions	
		Width 'A'	Thickness 'B'
111-018	3/8-24	35/64	41/64
111-020	7/16-20	5/8	49/64
111-022	1/2-20	3/4	13/16
111-024	5/8-18	15/16	1"

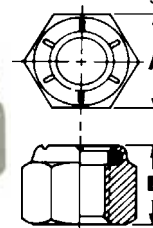

BRASS BRAKE BLOCK BOLTS BOULONS POUR SABOT DE FREIN

252 Series

Papco® Brass Brake Lining Fasteners, No. 252-221 and No. 252-354 are used to replace rivets on many truck and trailer applications. The 3/8" Dia. Brass Bolts are used on Brake Blocks. In each case the screw is Brass to avoid scoring and the hexagon nuts and lock washers are steel.

ORDER BY STOCK NUMBER

Standard Package: contains 100 Assemblies

Stock No.	Size	Description	Image	
252-221	10-32 x 1	Spec. Flat Brass Screw, Hex. Steel Nut, Lock Washer		
252-354	1/4-28 x 1	Spec. Flat Brass Screw, Hex. Steel Nut, Lock Washer		
252-489	3/8-16 x 1	Flat Head Brass Screw, Hexagon Steel Nut		
252-491	3/8-16 x 1-1/4	Flat Head Brass Screw, Hexagon Steel Nut		
252-493	3/8-16 x 1-1/2	Flat Head Brass Screw, Hexagon Steel Nut		

UNIVERSAL TAILPIPE BRACKETS
SUPPORT UNIVERSEL DE TUYAU D'ÉCHAPPEMENT

256
Series

Used to suspend exhaust system components such as mufflers, catalytic converters and tailpipes. Brackets No. 256-002 and 256-003 are used with muffler clamps.

Order by Stock Number Individually Packaged

Stock No.	Size & Description
256-001	6" Steel Strap 1-1/2 - 2-1/2 OD Pipe
256-002	4" Rubber Strap - 4 holes
256-003	7" Steel Strap Swivel End

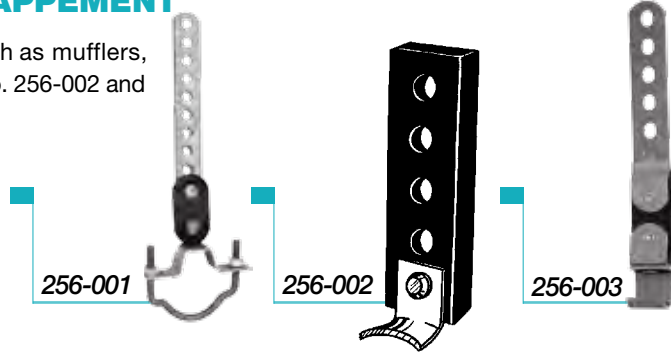

EXHAUST SYSTEM FASTENERS MASTER ASSORTMENT
ASSORTIMENT GÉNÉRAL DE FIXATIONS
POUR SYSTÈMES D'ÉCHAPPEMENT

No. 020-639

Contains Cap Screws, Carriage Bolts, Brass and Steel Engine Stud Nuts and Finished Hex Nuts. Gives complete coverage of the most common Exhaust System Fasteners. Sizes and quantities based on popularity.



MANIFOLD STUDS AND NUTS
MASTER ASSORTMENT
ASSORTIMENT GÉNÉRAL DE GOUJONS
ET ÉCROUS POUR RÉPARTITEUR

No. 020-632

Contains manifold studs and brass nuts. For complete listing, see next page.

STARTER BOLTS
BOULONS À DEMARREUR

257
Series

These hexagon washer head medium carbon steel plated bolts are replacements for damaged or missing starter mounting bolts.



Order by Card Numbers

Standard Package 5 pieces

Stock No.	Size	Application	Stock No.	Size	Application
257-005	3/8-16 x 1-5/16	GM 4.4, 5.0 & 5.7 lit.	257-055	M10 x 1.5 x 45	GM 2.0, 2.5 & 3.4 lit.
257-007	3/8-16 x 1-7/8	GM 3.8 lit., 6 cyl.	257-060	M10 x 1.5 x 102	GM 2.8 & 3.1 lit.
257-012	3/8-16 x 3-5/8	GM 6 & 8 cyl.	257-065	M10 x 1.5 x 113	GM 2.0, 2.5 & 3.4 lit.
257-015	3/8-16 x 4-5/16	GM 4.4, 5.0 & 5.7 lit.	257-070	M10 x 1.5 x 118	GM 2.0, 2.2, 2.5, 2.8, 3.1 & 3.4 lit.
257-017	3/8-16 x 4-1/2	GM 4.3 & 5.0 lit.			
257-018	3/8-16 x 4-5/8	GM 5.0 & 5.7 lit.			

ALTERNATOR BOLTS
BOULONS À ALTERNATEUR

These high-strength, head treated plated bolts are used as alternator mounting bolts on domestic and imported vehicles.



Order by Card Numbers

Standard Package 5 pieces

Stock No.	Size	Application	Stock No.	Size	Application
257-105	5/16-18 x 1-1/4	Universal	257-120	3/8-16 x 6	GM
257-110	5/16-18 x 5	GM	257-125	7/16-14 x 5-1/2	Ford
257-115	3/8-16 x 3-1/8	GM	257-155	M10 x 1.5 x 80	GM
257-118	3/8-16 x 4	Chrysler	257-160	M10 x 1.5 x 105	GM

CYLINDER HEAD BOLT KITS TROUSSE POUR BOULONS DE CULASSE

257
Series

Papco® Cylinder Head Bolts are made of high-strength Grade 8 steel. Original bolts may be permanently stretched when torqued. Torque-to-yield bolts **MUST** be replaced to avoid premature head gasket failure.

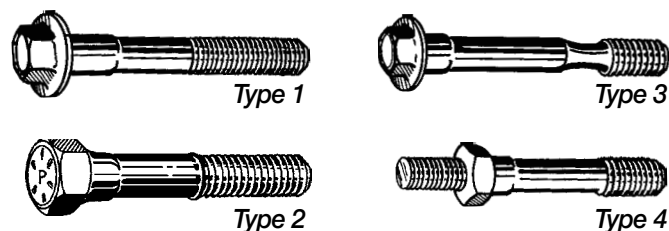

Type	Year	Cyl.	Engine Size	Size	Kit No.	Trq. to Yield	Pcs. /Kit	Factory No.			
CHRYSLER											
1	1981-up	(4)	2.2L (135), 2.5L (153)	M11 x 1.5 x 120	257-301	Yes	10	6501433			
1†	1987-up	(6)	3.0L (181) SOHC (Mits)	M12 x 1.25 x 102	257-303	Yes	16	MD065959			
1	1993-up	(6)	3.5L	1/2-13 x 1-7/8	257-304	Yes	16	6502665			
1	1957-up	(8)		(Short)	257-305	No	10	6031045			
1				(Medium)					1/2-13 x 4-1/2	8	6031101
1				(Long)					M11 x 1.5 x 190	2	2463260

Type	Year	Cyl.	Engine Size	Size	Kit No.	Trq. to Yield	Pcs. /Kit	Factory No.			
FORD											
1	1981-1984	(4)	1.6L, 1.9L Escort	M10 x 1.5 x 130	257-310	Yes	10	E4FZ-6065-A			
1	1974-95	(4)	2.3L (140) OHC	M12 x 1.75 x 100	257-311	No	10	D4FZ-6065-A			
1	1986-up	(6)	2.9L (177), 4.0L (244) Truck	M12 x 1.75 x 73	257-312	Yes	16	E6TZ-6065-A			
1	1986-up	(6)	3.0L (183) Exc: SHO	M11 x 1.5 x 102	257-313	Yes	16	E8DZ-6065-A			
2	1982-up	(6)	3.8L (232)	(Short)	257-315	Yes	8	F4SZ-6065-B			
2				(Long)					M11 x 1.5 x 100	8	F4SZ-6065-A
1	1991-up	(8)	4.6L (281) SOHC	M11 x 1.5 x 210	257316	Yes	20	F5AZ-6065-A			
2	1980-up	(8)	4.9L (300)	7/16-14 x 4	257-317	Yes	14	F3ZZ-6065-B			
2	1970-up	(8)	5.0L (302)	(Long)	257-318	Yes	10	F3ZZ-6065-B			
2				(Short)					7/16-14 x 2-7/16	8	F3ZZ-6065-C
4				(w/stud)					7/16-14 x 3-7/8	2	F3ZZ-6065-D
3	1970-up	(8)	5.8L (351) Windsor	(Short)	257-319	No	20	C902-6065-A			
3				(Long)					1/2-13 x 4	20	C902-6065B

Type	Year	Cyl.	Engine Size	Size	Kit No.	Trq. to Yield	Pcs. /Kit	Factory No.			
GENERAL MOTORS											
1	1985-95	(4)	1.6L (98) 4, 5, 6 Geo	M10 x 1.5 x 94	257-331	Yes	10	96061591			
3	1982-94	(4)	1.8L, 2.0L, OHC H, K, M		257-332	Yes	2	10031210			
4				(w/stud)					M11 x 1.5 x 185	4	10031213
4				(w/stud)					M11 x 1.5 x 165	4	10031214
1	1987-93	(4)	2.3L (138) QUAD IV DOHC		257-334	Yes	2	22531281			
1				(Long)					M12 x 1.75 x 98	8	22531282
4	1980-up	(4)	2.5L (151) A, E, 5, R, 2	(w/stud)	257-336	Yes	1	12338010			
4				(w/stud)					M11 x 1.5 x 99	1	12338012
1									M11 x 1.5 x 99	8	12338018
1	1987-96	(6)	2.8L (173) W, 3.1L (189) VIN T		257-338	Yes	8	10100033			
1									M11 x 1.5 x 108	8	10227593
1	1982-95	(6)	2.8L (173), 3.1L (189) M, T, W		257-339	No	8	476572			
1									M11 x 1.5 x 93	8	476543
3	1975-up	6)	3.8L (231) A, B, G	7/16-14 x 2-11/16	257-340	No	8	1243262			
1				2, 3, 7, 8, 9, C L					7/16-14 x 3-1/2	8	1253539
3	1955-up	(6-8)	4.3L (262) Z, 305, 327 350, 400	7/16-14 x 3-3/4*	257-341	No	14	14082317			
3				7/16-14 x 1-3/4*					16	14082316	
3				7/16-14 x 3*					4	14082315	
1	1982-up	(8)	6.2L (381), 6.5L (395) Diesel	7/16-14 x 3	257-342	No	34	14077193			
1	1971-up	(8)	366, 427, 454 Truck	(Long)	257-343	No	8	10141204, 3877668			
1				(Short)					7/16 x 2-1/16	24	10141205, 3877669

† Round Head

* with GM 9985490 Thread Sealant

**with GM 6124M Thread Sealant

**SQUARE HEAD PIPE PLUGS
BOUCHONS DE TUYAU TÊTE CARRÉE**

**260
Series**

With **LOCTITE® Vibra-Seal®**

These forged steel pipe plugs are used as drain and filler plugs on all cars, trucks, tractors and stationary engines. Made with Dryseal American National Pipe Threads. For improved reliability Papco® Pipe Plugs feature LOCTITE® Vibra-Seal® pre-applied thread sealant.

ORDER BY STOCK NUMBER Standard Package: 12 Plugs

Stock #	Iron Pipe Size Thread	Approximate Dia. Small End
260-901	1/8-27	3/8
260-902	1/4-18	1/2
260-903	3/8-18	5/8
260-904	1/2-14	7/8
260-906	3/4-14	1"



GARAGE ASSORTMENT

No. 020-043

Contains 20 Square Head Pipe Plugs in 1/8", 1/4" and 3/8" iron pipe sizes. Packed in a clear, plastic box.



020-043

GARAGE ASSORTMENT

No. 020-087

Contains 20 Socket Pipe Plugs in 1/8, 1/4 and 3/8 iron pipe sizes. Packed in a sturdy, transparent, plastic box.

UTILITY ASSORTMENT

No. 020-332

Contains 42 Square Head Pipe Plugs in 1/8", 1/4", 3/8" and 1/2" pipe sizes. Packed in a sturdy fibreboard container with moulded compartments.



020-043

**SOCKET PIPE PLUGS
BOUCHONS DE TUYAU CREUX**

**260
Series**

ORDER BY STOCK NUMBER

Stock #	Iron Pipe Size Thread
260-921	1/8-27
260-922	1/4-18
260-923	3/8-18
260-924	1/2-14



Standard Package: 12 Plugs

AIR CLEANER WING NUTS ÉCROUS À OREILLES POUR FILTRE À AIR

262
Series

Universal type replacements for lost or stripped Air Cleaner Wing Nuts. Self-threaded series nylon nuts cut their own thread and may be used on either inch or metric hold-down shafts.

ORDER BY STOCK NUMBER

							
Stock No.	Size	Description	Qty	Stock No.	Size	Description	Qty
262-314	1/4 & 6 mm	Self Threading Nylon	10	262-326	1/4-20	Chrysler Nylon	5
262-316	5/16 & 8mm	Self Threading Nylon	10	700-106	M6 x 1.0	Metric Wing Nut	25
262-324	1/4-20	Universal Domestic	10	700-108	M8 x 1.25	Metric Wing Nut	25
262-325	M6 x 1.0	Universal Imports	10				

WING NUT AND HOOD PROP CLIP MASTER ASSORTMENT

No. 020-608

Contains 90 pieces - 16 sizes of all listed Air Cleaner Wing Nuts as above - plus 5 sizes of Hood Prop Clips (see page 7). Packed in a rigid, all metal lidded box.

020-608



**THROTTLE ROD CLIPS AND RETAINERS
ATTACHES DE TIGE À SOUPAPE**

**262
Series**

Papco[®] Throttle Rod Clips are made of hardened spring steel in right and left hand styles. The retainer springs, or hairpin cotters, are measured by the diameter of the centre eye.

ORDER BY STOCK NUMBER

											
Stock No.	Size	Type	Std. Pkg.	Stock No.	R. Dia.	Type	Std. Pkg.	Stock No.	Size	Type	Std. Pkg.
262-008*	5/32 R	1	25	262-056*	1/8	2	25	262-078*	5/32	3	100
262-009*	5/32 L	1	25	262-060*	1/4	2	25	262-080	7/32	3	100
262-010*	3/16 R	1	25	262-062*	1/8 (GM)	4	25	262-084	1/4	3	100
262-011*	3/16 L	1	25	262-064*	1/4 (GM)	4	25	262-086	5/16	3	100
262-014*	1/4 R	1	25	262-073*	1/16	3	100	262-088	3/8	3	100
262-015*	1/4 L	1	25	262-075*	5/64	3	100	268-516	5/16	5	18
262-054*	3/32	2	25	262-076*	1/8	3	100				

*Retainers

CARBURETOR CLIP MASTER ASSORTMENT

No. 020-609

Contains 293 pieces, 18 sizes for complete coverage. Packed in an all metal, lidded box. See page 6 for contents listing.

THROTTLE ROD CLIP GARAGE ASSORTMENT

No. 020-022

Contains 104 pieces, *15 sizes as listed above, includes both clips and hairpin cotters. Packed in a transparent plastic box with individual sections. Useful for carburetor repair jobs.



020-022

**THROTTLE BALL JOINTS
JOINTS À ROTULE**

Used to adjust throttle linkages and control rods on automobiles, trucks, snowmobiles, marine and off the road equipment. Made of heat treated carbon steel and bright plated for corrosion resistance.

Type G (Solid)		High-strength design with good wear resistance for heavy duty service. Oil and gas resistant rubber shield protects against abrasive dirt.
Type A (Spring Loaded)		Conforms to S.A.E. Standards with case hardened seats and ball studs for extra wear resistance. Spring loaded for zero end-play.
Type P (Quick Disconnect)		Lightweight economical quick disconnect design. Ball studs can be removed from spring steel retaining clip for making length adjustments.

Convenient skin-packed card contains one Ball Joint.

ORDER BY CARD NUMBER

Individually Carded

Card No.	Type	Size	Card No.	Type	Size
262-203	G	10-32	262-208	G	1/2-20
262-204	G	1/4-28	262-210	A	10-32
262-205	G	5/16-24	262-211*	A	1/4-28
262-206*	G	3/8-24	262-212*	A	5/16-24
262-207	G	7/16-20	262-218	P	1/4-28

* Most Popular

DRAIN COCKS ROBINETS DE VIDANGE

263 Series

Papco[®] Plastic Drain cocks for low pressure applications. For water, air, gas, anti-freeze and other fluids. (Not intended for natural gas, LPG or lubricants.)



Order by Card Numbers

Plastic Drain Cocks		
Stock No.	Pipe Size	Factory No. Appl.
263-951	5/16 (7/16-20)	GM: 3042160
263-952	1/4 x 1-1/2	GM: 305104 FORD: E1FZ-8115A
263-953	1/4 x 1-7/8	FORD: E57H-B115A
263-957	10 mm x 1.25	NISSAN: 21480-RD100 SUBARU: 7451-24010

Standard Package 5 pieces

Brass Drain Cocks		
Stock No.	Pipe Size	Type
D40-A	1/8	Back Sealing
D40-B	1/4	Back Sealing
D40-C	3/8	Back Sealing
D43-A	1/8	Outlet Fitting
D44-A	1/8	Outlet Fitting
D39-B	1/4	External Sealing

DRAIN COCKS MASTER ASSORTMENT ASSORTIMENT GÉNÉRAL DE ROBINETS DE VIDANGE

263 Series

No. 020-606

Contains 119 pieces of Plastic and Brass Drain Cocks - plus compression Sleeves, Nuts, Unions and four sizes of Hex Head Pipe Plugs.

- All metal box with hinged lid and handy carrying handle.
- Plastic, moulded compartmentalized tray.
- Illustrated lid label with retail price codes and refill stock numbers.

020-606



DRUM FAUCET

No. 913-026

For use with oils, kerosene, gasoline, naphtha, alcohol, lacquers, varnishes, thinners, solvents of all kinds, anti-freeze solutions and other liquids, hot or cold.

The Papco[®] Sette Faucet is simple in design and has an all nylon seat for extended life.

Extra thin liquids that are impossible to hold with ordinary faucets are held absolutely and permanently tight by Papco[®] Sette Faucets.

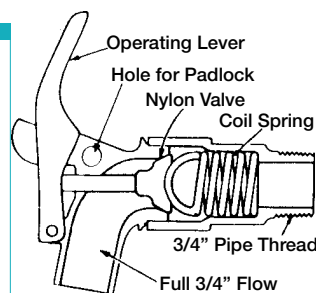

913-026



ENGINE STUDS AND NUTS
GOUJONS ET ÉCROUS DE MOTEUR

264
Series

Papco[®] Engine Studs will service all popular makes of cars. They have extra long threads and can be cut to size where a shorter stud is required.

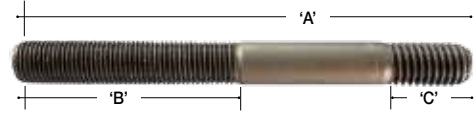

Order by Card Numbers

Standard Package 12 pieces

Stock No.	Length Dia. x 'A'	Dimensions		Stock No.	Length Dia. x 'A'	Dimensions	
		'B'	'C'			'B'	'C'
264-016	5/16 x 1-3/4	7/8 UNF	5/8 UNC	264-092	7/16 x 2-1/4	7/8 UNF	7/8 UNC
264-018	5/16 x 2	7/8 UNF	3/4 UNC	264-094	7/16 x 2-3/8	7/8 UNF	5/8 UNC
264-024	5/16 x 2-1/2	1-1/2 UNF	1/2 UNC	264-096	7/16 x 2-1/2	7/8 UNF	3/4 UNC
264-032	5/16 x 3	1-1/2 UNF	5/8 UNC	264-102	7/16 x 3-1/4	1-7/8 UNF	5/8 UNC
264-048	3/8 x 2	1 UNF	3/4 UNC	264-103	7/16 x 3-1/4	1 UNF	3/4 UNC
264-049	3/8 x 2	1 UNC	5/8 UNC	264-108	7/16 x 3-5/8	1-3/4 UNF	5/8 UNC
264-058	3/8 x 2-3/4	1 UNF	3/4 UNC	264-110	7/16 x 4	1-7/8 UNF	5/8 UNC
264-060	3/8 x 3	1-1/4 UNF	3/4 UNC	264-134	1/2 x 2-1/2	1 UNF	3/4 UNC
264-066	3/8 x 4	2 UNC	3/4 UNC	264-140	1/2 x 2-7/8	7/8 UNC	3/4 UNC
264-067	3/8 x 4	2 UNF	3/4 UNC	264-150	1/2 x 4	2 UNF	3/4 UNC
264-086	7/16 x 1-3/4	9/16 UNF	1/2 UNC				
264-088	7/16 x 2	7/8 UNF	3/4 UNC				

MANIFOLD STUDS
GOUJONS POUR COLLECTEUR

264
Series

Low Carbon Steel

Papco[®] Low - Carbon Manifold Studs are easily removed if rusted, broken or stripped. Simply drill out or burn out with a torch. Preferred by muffler shops everywhere. Coarse thread both ends.

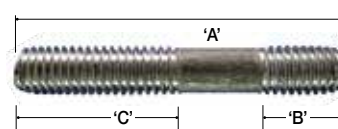

Order by Card Numbers

Standard Package 10 pieces

Stock No.	Length Dia. x 'A'	Dimensions		Stock No.	Length Dia. x 'A'	Dimensions	
		'B'	'C'			'B'	'C'
264-504	3/8-16 x 2	5/8 NC	1-1/8 NC	264-519	7/16 -14 x 3	5/8 NC	2" NC
264-507	3/8-16 x 2-1/2	5/8 NC	1-1/4 NC	264-523	7/16 -14 x 4	5/8 NC	2" NC
264-509	3/8-16 x 3	5/8 NC	2" NC	264-640	M8 x 1.25 x 40	16 mm	19 mm
264-510	3/8-16 x 3-1/4	5/8 NC	1-5/8 NC	264-650	M10 x 1.5 x 50	16 mm	19 mm
264-517	7/16-14 x 2-1/2	5/8 NC	1-1/4 NC				

METRIC STUDS GOUJONS DE MOTEUR MÉTRIQUE

264
Series

Conform to I.S.O. Class 8.8 Specifications. For manifolds, rocker covers and general engine uses.

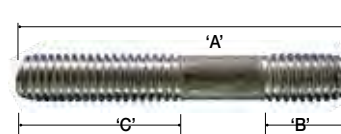

For Metric Steel Nuts see page 37.

Standard Package 10 Studs

Stock No.	Dia. x Pitch x Length 'A'	'B' mm	'C' mm	Application	Stock No.	Dia. x Pitch x Length 'A'	'B' mm	'C' mm	Application
264-230	M6 x 1.00 x 30 mm	14	12	VW - 056 - 103 - 400	264-440	M6 x 1.25 / M10 x 1.50 x 35 mm	14 (M8)	19 (M10)	Universal
264-328	M6 x 1.25 x 28 mm	15	10	VWN044 - 511 - 1	264-441	M10 x 1.25 x 37 mm	13	21	Universal
264-335	M6 x 1.25 x 35 mm	17	12	VWN044 - 514 - 2	264-443	M10 x 1.25 x 43 mm	21	16	DAT14064-N4200
264-338	M6 x 1.25 x 38 mm	20	10	VWN14 - 443 - 8	264-450	M10 x 1.25 x 50 mm	25	15	Universal
264-346	M6 x 1.25 x 46 mm	23	16	VWN044 - 410 - 2(-4)	264-451	M10 x 1.50 x 50 mm	25	15	Universal
264-348	M6 x 1.25 x 50 mm	23	10	Universal	264-452	M10 x 1.50 x 52 mm	27	12	Universal
264-350	M6 x 1.25 x 55 mm	23	10	Universal	264-453	M10 x 1.50 x 62 mm	28	12	Universal
264-352	M6 x 1.25 x 60 mm	24	10	Universal	264-455	M10 x 1.50 x 65 mm	46.5	13.5	Universal
264-354	M6 x 1.25 x 65 mm	19	10	Universal	264-457	M10 x 1.50 x 77 mm	28	12	Universal
264-356	M6 x 1.25 x 70 mm	24	10	Universal					

ENGINE STUD NUTS GOUJONS DE MOTEUR

Standard Package 25 Nuts

Hex Brass Nuts			
Stock No.	Size & Thread	Width Across Flats	Thickness
264-953	5/16 UNF	1/2	17/64
264-954	5/16 UNC	1/21	17/64
264-955	3/8 UNF	9/16	21/64
264-956	3/8 UNC	9/16	21/64
264-957	3/8 UNC	9/16	5/8
264-958	7/16 UNF	11/16	3/8
264-959	7/16 UNC	5/8	3/8
264-960	1/2 UNF	3/4	7/16
264-961	1/2 UNC	3/4	7/16



Standard Package 25 Nuts

High Strength Steel Nuts			
Stock No.	Size & Thread	Width Across Flats	Thickness
264-903	5/16 UNF	1/2	17/64
264-905	3/8 UNF	9/16	21/64
264-908	7/16 UNF	11/16	3/8
264-909	7/16 UNC	11/16	3/8
264-910	1/2 UNF	3/4	7/16



For Papcolloy Hardened Steel Washers see page 63.

ENGINE STUDS AND NUTS MASTER ASSORTMENT ASSORTIMENT GÉNÉRAL DE GOUJONS ET ÉCROUS POUR MOTEUR

No. 020-632

Will service all exhaust manifold applications. Complete car coverage. All parts illustrated on hinged lid of sturdy metal merchandiser. Handy carrying handle with snap lock.

For **SUPER-SERVICE ASSORTMENT**
No. **020-818** of Engine Studs and Nuts
please refer to page 10.

020-632



**THICKNESS GAUGES
CALIBRES D'ÉPAISSEUR**

**267
Series**

Papco[®] Thickness Gauges are made from No. 1 Grade Swedish Steel, uniformly tempered and are of the highest accuracy obtainable. Each gauge is 12" long by 1/2" wide and has a hole punched in the end for hanging. The thickness in thousandths is permanently etched on the gauge.

Standard package contains six lengths of a size, and each gauge is individually cellophane wrapped.

ORDER BY STOCK NUMBER

Standard Package: 6 Lengths

Stock No.	Thickness	Stock No.	Thickness	Stock No.	Thickness
267-015	.0015	267-110	.010	267-120	.020
267-020	.002	267-111	.011	267-122	.022
267-025	.0025	267-112	.012	267-124	.024
267-030	.003	267-113	.013	267-125	.025
267-040	.004	267-114	.014	267-126	.026
267-050	.005	267-115	.015	267-128	.028
267-060	.006	267-116	.016	267-130	.030
267-070	.007	267-117	.017	267-132	.032
267-080	.008	267-118	.018	267-140	.040
267-090	.009	267-119	.019		

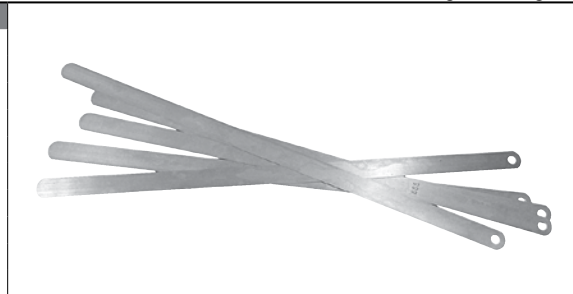

**PRECISION CALIPER
COMPAS PRÉCISION**

No. 022-031

Papco[®] Precision Caliper is made of high impact styrene. Useful for all types of measurements in both inch and metric. Measures inside diameter, outside diameter, length and depth. Scales in 1/16" or 1 mm increments. Individually skin-packed.



**BOLT AND NUT GAUGES
CALIBRES POUR BOULONS ET ÉCROUS**

No. 022-030

Bolt & Screw Gauge

Heavy duty, plastic gauge for measuring UNC, UNF and Metric bolts, nuts, screws and studs. Individually packaged.

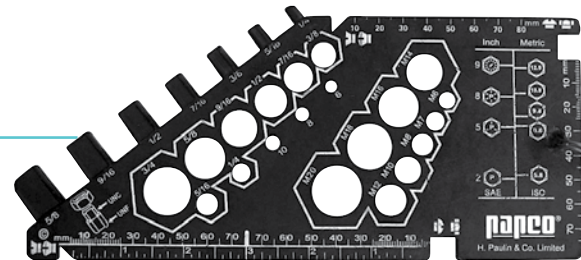

No. 022-034

Ultimate Bolt & Screw Gauge

Heavy duty steel construction. Measures bolts, nuts and screws by length, diameter and thread. Includes Imperial and Metric sizes (UNC & UNF) as per IFI Standard.



THREAD DETECTIVE® IMPERIAL/METRIC • IMPÉRIAL/MÉTRIQUE

No. 022-185

- This Thread Detective is an easy and precise thread identifier for both nuts and bolts, consisting of gliding gauges conveniently assembled onto a wire lanyard.
- It is well suited for distinguishing between similar inch and metric threads.
- Thread sizes are stamped onto each gauge and are coated with a PVC shrink tubing ensuring numbers will never rub off.
- Thread Detective® is equipped with a 3-3/8" (85mm) ruler for measuring stud lengths.
- It has a convenient extra long rope for those hard to reach places, as well as loops on each end for hanging.

Inch identifiers consist of nut and bolt sizes

6-32, 8-32, 10-24, 10-32, 1/4-20, 1/4-28, 5/16-18, 5/16-24, 3/8-16, 3/8-24, 7/16-14, 7/16-20, 1/2-13 and 1/2-20.

Metric identifiers consist of nut and bolt sizes

M4 x 0.7, M5 x 0.8, M6 x 1.0, M8 x 1.0, M8 x 1.25, M10 x 1.0, M10 x 1.25, M10 x 1.5, M12 x 1.25, M12 x 1.5 and M12 x 1.75.



ANTI-FREEZE TESTER VÉRIFICATEUR D'ANTIGEL

No. 263-999

- Tests all ETHYLENE GLYCOL solutions.
- Allows visual inspection for rust and sediment.
- Shows both degrees Fahrenheit and Celsius.
- Individually blister-packed.

Winter Protection

Accurately and quickly indicates the freezing point of radiator solution.

Summer Protection

Indicates boiling point of coolant.



For Battery Tester 570-250
see page 194.

MUFFLER CLAMPS COLLIERS DE SILENCIEUX

256 Series

Papco® Muffler Clamps provide a full 360° seal between muffler and pipes. designed for easier installation and trouble-free service. Assembly consists of heavy gauge saddle, 'U' bolt and two nuts, packed in an individual container.

- Heavy Gauge Steel
- Pipe Size stamped in clamp
- Complete coverage from 1-1/4" to 4" Pipe dia.
- Full depth saddle for extra strength
- Heavy rolled thread 'U' Bolts
- Secure fit between tail pipe and muffler



Use for Inch and Metric applications

Order by Stock Number

5/16" diameter 'U' Bolts			3/8" diameter 'U' Bolts		
Stock #	Pipe Size	Metric Eqv.	Stock #	Pipe Size	Metric Eqv.
256-010	1-1/4	32 mm	256-114	1-3/4	45 mm
256-012	1-1/2	38 mm	256-115	1-7/8	48 mm
256-013	1-5/8	41 mm	256-116	2	51 mm
256-014	1-3/4	45 mm	256-117	2-1/8	54 mm
256-015	1-7/8	48 mm	256-118	2-1/4	57 mm
256-016	2	51 mm	256-120	2-1/2	64 mm
256-017	2-1/8	54 mm	256-124	3	76 mm
256-018	2-1/4	57 mm	256-128	3-1/2	89 mm
256-020	2-1/2	64 mm	256-132	4	102 mm

'SEALTITE' WORM GEAR HOSE CLAMPS COLLIERS DE BOYAUX 'SEALTITE'

307 Series

308 Series

- QUALITY** ■ "301" Stainless Steel Band and Housing. Hi-strength Hex Plated Steel Screw. No loose parts.
- EASY TO USE** ■ Goes on with hose in position. Combination Hex Screw tightens with screw driver or wrench.
- RANGE** ■ Wide size range for each clamp.
- STRENGTH** ■ Wide band for even pressure. Won't cut hose. Full-formed teeth will never slip.



All Stainless Steel for 308 Series

Papco® Sealtite Hose Clamps are manufactured from the highest quality materials for reliable operation in any Automotive or Industrial applications. The aircraft principle of the worm gear drive gives this clamp a powerful sealing action that meets the toughest requirements. Standard clamp features '301' (18.8) Stainless Steel band and housing with a Zinc Plated Steel Screw. The All-Stainless Steel clamp Features a '301' (18.8) Stainless Steel band and housing with a '305' Stainless Steel Screw.

ORDER BY STOCK NUMBER

Standard Package: Contains 10 Hose Clamps

Stock No.		Nominal Size	Fits Hose O.D.	Stock No.		Nominal Size	Fits Hose O.D.
Standard	All-Stainless			Standard	All-Stainless		
307-001	308-001	5/16"	7/32 - 5/8	307-032	308-032	2"	1-9/16 - 2-1/2"
307-002	308-002	7/16"	5/16 - 7/8	307-036	308-036	2-1/4"	1-13/16 - 2-3/4"
307-008	308-008	1/2"	7/16 - 15/16	307-040	308-040	2-1/2"	2-1/16 - 3"
307-010	308-010	5/8"	9/16 - 1-1/16	307-044	308-044	2-3/4"	2-5/16 - 3-1/4"
307-012	308-012	3/4"	5/8 - 1-1/4	307-048	308-048	3"	2-9/16 - 3-1/2"
307-016	308-016	1"	11/16 - 1-1/2	307-052	308-052	3-1/4"	2-13/16 - 3-3/4"
307-020	308-020	1-1/4"	13/16 - 1-3/4	307-056	308-056	3-1/2"	3-1/16 - 4"
307-024	308-024	1-1/2"	1 1/16 - 2	307-060	308-060	3-3/4"	3-5/16 - 4-1/4"
307-028	308-028	1-3/4"	1-5/16 - 2-1/4	307-064	308-064	4"	3-13/16 - 4-1/16"

'SNAPPER' HOSE CLAMPS COLLIERS DE BOYAUX 'SNAPPER'

307 Series

Papco® Nylon 6/6 Snapper Hose Clamps form an instant grip on hoses in automobile repair or whenever a quick application is required. Teeth mesh together and are set by using pliers and released by sliding jaws sideways. Will not rust – non-conductive. For pressures up to 120 p.s.i. UV stabilized.

ORDER BY STOCK NUMBER

Standard Package: 10 Clamps

Stock No.	Fits Hose I.D.	Clamp Range		Stock No.	Fits Hose I.D.	Clamp Range	
		Minimum	Maximum			Minimum	Maximum
307-505	5/16"	19/64"	11/32	307-516	1"	63/64"	1-9/64"
307-506	3/8"	23/64"	25/64	307-517	1-1/8"	1-1/8"	1-13/64"
307-507	7/16"	13/32"	29/64	307-519	1-3/16"	1-7/32"	1-19/64"
307-508	1/2"	33/64"	19/32	307-520	1-1/4"	1-9/32"	1-19/32"
307-509	9/16"	9/16"	21/32	307-522	1-1/2"	1-15/32"	1-23/32"
307-510	5/8"	39/64"	45/64	307-524	1-3/4"	1-47/64"	2-1/64"
307-512	3/4"	3/4"	27/32	307-526	2"	2"	2-15/64"
307-513	13/16"	25/32"	29/32	307-528	2-1/4"	2-1/4"	2-37/64"
307-514	7/8"	55/64"	63/64				



FUEL INJECTION HOSE CLAMPS COLLIERS DE BOYAUX POUR INJECTEUR D'ESSENCE

Manufactured specifically for all fuel injection applications. Non-perforated band is aluzinc coated carbon steel with a zinc plated carbon steel screw and nut. Band width approximately 3/8".

ORDER BY STOCK NUMBER

Standard Package: 10 Clamps

Stock No.	Fits Hose I.D.	Clamp Range		Stock No.	Fits Hose I.D.	Clamp Range	
		Minimum	Maximum			Minimum	Maximum
307-570	1/4"	7/16"	1/2"	307-572	3/8"	9/16"	5/8"
307-571	5/16"	1/2"	19/32"				



GARAGE ASSORTMENT

No. 020-096

Contains 28 Hose Clamps - 3 sizes in a compartmentalized, clear styrene plastic box.



020-096

CONSTANT TENSION HOSE CLAMPS COLLIERS DE BOYAUX A TENSION CONSTANTE

Metal pinch or squeeze type clamp commonly used on fuel, vacuum and other low pressure lines.

ORDER BY STOCK NUMBER

Standard Package: 25 Clamps

Stock No.	Fits Hose	Max. Clamp	Colour
	O.D.	Dia. Open	
307-560	3/8"	.321	Black
307-561	7/16"	.405	Green
307-562	1/2"	.460	Red
307-564	5/8"	.583	Olive
307-566	3/4"	.645	Black
307-568	1"	.910	Black



020-097

GARAGE ASSORTMENT

No. 020-097

Contains 55 Clamps - 6 sizes packed in a transparent, plastic container with a hinged lid.

NYLON CABLE CLAMPS COLLIERS DE CABLE NYLON

400 Series

Papco[®] 6/6 Black Nylon Cable Clamps are tough, resilient, light-weight and highly resistant to wear, most chemicals such as gasoline, oil etc. and destructive U-V rays. Used to secure cables, pipes, tubing, wire etc. in automotive, marine, appliance, commercial and residential applications. All Nylon Clamps provide excellent insulation characteristics.

ORDER BY STOCK NUMBER

Stock No.	Cable Size	Clamp Width	Standard Package	Stock No.	Cable Size	Clamp Width	Standard Package
400-522	1/4	3/8	50	400-528	5/8	1/2	25
400-524	3/8	3/8	50	400-530	3/4	1/2	25
400-526	1/2	3/8	50	400-532	1	1/2	15



GARAGE ASSORTMENT

No. 020-088

Contains 40 pieces - 6 sizes of Nylon Cable Clamps listed above. Packed in a sturdy, clear, plastic box.



020-088







NOTE: For a complete listing of clamps, please refer to our current *Dominion Fittings Fluid Flow Components Catalogue*.

**PUSH-PULL CONTROLS
CABLES DE CONTRÔLE**

**310
Series**

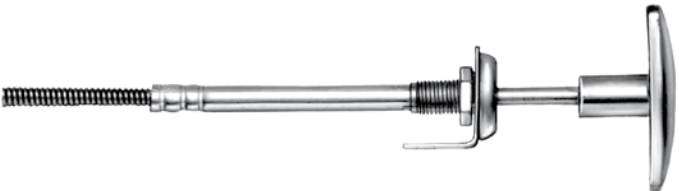
For choke, throttle, hood, air vents, heater valves, mowers, snow blowers, power take-off etc. All controls are individually packaged for point of sale display.

ORDER BY STOCK NUMBER

Stock No.	Length	Description	
310-120	60" long	Utility Controls Round black knob to complete any dash panel. 2" travel, 3/16 OD. Gal. Casing, .054" HC Wire, 3/8-24 housing thread	
310-121	72" long		
310-136	180" long	Standard Assembly Round lustrous black knob. Includes mounting bracket and finishing washer plated. 2" travel, 3/16 OD. Casing, .054" HC Wire, 3/8-24 housing thread	
310-152	84" long	'T' handle Assembly Chrome plated metal handle. Plated assembly. Includes mounting bracket and finishing washer. 2" travel, 3/16 OD. Casing, .054" HC Wire, 3/8-24 housing thread	
310-173	108" long	'T' handle Heavy Duty Locking Assembly Locks with half turn. Brass Clutch. Chrome Handle. Includes dash mount bracket and finishing washer. Full floating core does not turn with handle. 2" travel, 3/16 OD. Casing, .062" HC Wire, 3/8-24 housing thread	
310-181	72" long	T handle Heavy Duty Locking Assembly Turn and lock. Brass locking clutch. Chrome Handle. Plated. Heavy Duty Housing with 2" thread length. Full floating core wire. 2" travel, 3/16 OD. Casing, .062" HC Core Wire, 1/2-20 housing thread	
310-183	108" long	Marine Control For boats, other marine and hostile environment applications. Casing is 3/16" Dia. REINFORCED Nylon. 'T' Handle is chrome plated. Brass housing. Full floating core wire. 2" travel, 3/16" Vinyl Coated casing w/HDPE Liner, .062" Stainless Core Wire, 3/8-24 housing thread.	
310-194	120" long	Power Take Off Controls Used primarily as dash mounted power takeoff control on trucks and mobile equipment. Nylon lined, metal reinforced vinyl casing. Plated for corrosion resistance. Large 2" Dia. round plastic knob. 7/16-20 x 1-1/2" long housing. Includes mounting nut and lock washer. Individually boxed.	
310-198	240" long	4" travel, 5/16" Vinyl Coated Casing, .093" Stainless Core Wire, 7/16-20 housing thread	

HEAVY DUTY VERNIER CONTROL CONTRÔLE VERNIER EXTRA-ROBUSTE

310
Series

Recommended for heavy truck, bus, agricultural and off-highway uses. Heavy duty easy-action control for critical adjustments. This accurate Vernier Control has a unique three prong locking collar. Designed for one-hand setting and locking in place. Make accurate fine adjustments by rotating knob - depress central button and push or pull for coarse setting.

Long life working parts are brass and stainless, weather resistant 5/16" O.D. reinforced vinyl casing and liner, .072" stainless steel core wire x 120" long. Housing is 3/4-16 x 2-9/16" long with hex panel nut, mounting nut and lock washer. Travel is 3-5/8".

No. 310-216
120" long, individually boxed.

310-216



CHOKE CONVERSION KITS TROUSSES DES CONVERSION A L'ÉTRANGLEUR

Helps eliminate hard winter starts. Allows driver to control choke. Instant control of air and gas mixture from dash. Order by stock number. Complete instructions included. Individually packaged.

SEMI-AUTOMATIC TYPE

No. 310-245

Allows manual override. Exclusive "Magic-Link" lets engine breathe even under full choke. Fits AMC, GM, Ford and Chrysler cars. 60" cable.

No. 310-246

Fits all light and medium domestic trucks. Has long 108" cable.

COMPLETE MANUAL OPERATION TYPE

No. 310-250

Universal kit. For most domestic made cars. Cable is 60" long.

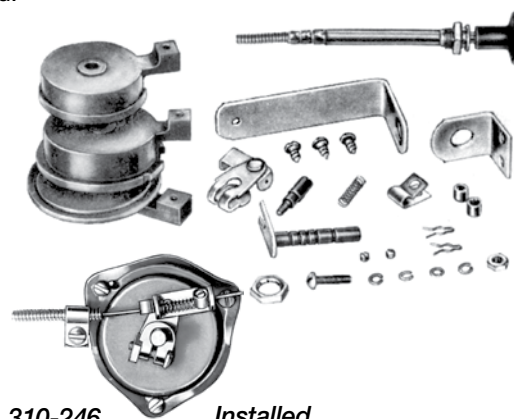

310-246

Installed

UNIVERSAL SPEEDOMETER CABLE KIT TROUSSE DE CABLE POUR INDICATEUR DE VITESSE

This complete kit includes 81" long standard multi-strand flexible shafting with .104" squared lower end. Cut shafting to length of original speedometer cable and attach the square tip with the staking tool provided. Fits most cars, trucks and RV's.

No. 310-281

Individually Packaged
81" Flexible shafting, tip and tool.

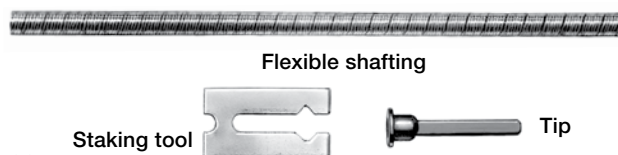

310-281

CONTROL WIRE STOPS BLOQUEURS POUR CONTRÔLE DE BROCH

Universal type. For push-pull controls, choke control wires, hood release latches and throttle cables. Position cable stop against control arm of lever and tighten screw. Order by stock number. Standard package 25 pieces.

No. 310-353

1/4" for 1-16" wire.

310-353



No. 310-354

3/8" for 1/8" wire.

310-354



**CARBURETOR AND THROTTLE RETURN SPRINGS
RESSORTS DE CARBURATEUR ET SOUPEPE DE RÉGLAGE**

ORDER BY STOCK NUMBER

Standard Package: Contains 12 Springs

Stock No.	Description	
311-001	Universal Throttle Return Spring. Can be adapted for use on all carburetor and accelerator pedals. Spring measures 12" overall and plain end can be cut to required length.	
311-002	Carburetor Return Spring. Attach to screw on carburetor body and hook to throttle valve arm. Acts as a helper spring for throttle return - prevents racing and sticking accelerator. For G.M. and Chrysler cars.	

**CARBURETOR SPRING DISPLAY
ASSORTIMENT RESSORT DE CARBURATEUR**

No. 020-878

Contains 12 each No. 311-001, No. 311-002 Springs mounted on attractive three colour merchandising display card.

020-878



**UNIVERSAL PEDAL RETURN SPRINGS
RESSORTS REVENIR DE PÉDALE UNIVERSEL**

FOR ALL BRAKE AND CLUTCH PEDALS

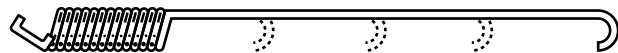

No. 311-101

18-1/2" overall x 13/16" O.D. x 2" Coil x 7/64" Dia. wire.

311-101

No. 311-103

18-1/2" overall x 3/4" O.D. x 3-1/2" Coil x 1/16" Dia. wire.

Standard Package 12 Springs

311-103

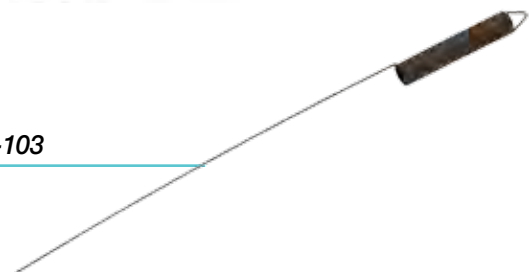

UTILITY SPRINGS RESSORTS D'UTILITÉ

311
Series

COMPRESSION TYPE / EXTENSION TYPE

In sizes suitable for most requirements

COMPRESSION TYPE



ORDER BY STOCK NUMBER

Standard Package: 12 Pieces

Stock No.	Outside Dia.	Length	Wire Size	Stock No.	Outside Dia.	Length	Wire Size
311-639	3/32"	7/8"	.020"	311-601	3/8"	11-1/2"	.051"
311-676	3/16"	5"	.026"	311-655	7/16"	2-3/4"	.045"
311-615	1/4"	1-1/2"	.041"	311-622	7/16"	3"	.062"
311-677	1/4"	5"	.034"	311-682	7/16"	5"	.062"
311-618	9/32"	2"	.022"	311-683	1/2"	5"	.072"
311-678	5/16"	5"	.047"	311-620	5/8"	2-1/2"	.081"
311-679	5/16"	5"	.054"	311-646	5/8"	3"	.062"
311-656	3/8"	2"	.034"	311-653	5/8"	3-3/8"	.080"
311-650	3/8"	2-3/4"	.045"	311-602	5/8"	11-1/2"	.057"
311-680	3/8"	5"	.054"	311-603	7/8"	10"	.081"
311-681	3/8"	5"	.062"				

EXTENSION TYPE



ORDER BY STOCK NUMBER

Standard Package: 12 Pieces

Stock No.	Outside Dia.	Length	Wire Size	Stock No.	Outside Dia.	Length	Wire Size
311-633	1/8"	9/16"	.018"	311-630	5/16"	5-3/8"	.041"
311-684	1/8"	15/16"	.020"	311-608	5/16"	6"	.034"
311-634	1/8"	1-3/8"	.018"	311-659	5/16"	6-3/4"	.034"
311-612	5/32"	2-1/8"	.028"	311-658	5/16"	7-1/4"	.045"
311-636	3/16"	1-1/8"	.025"	311-610	11/32"	3"	.041"
311-616	3/16"	1-1/4"	.014"	311-685	3/8"	1-7/8"	.031"
311-623	3/16"	2-1/2"	.028"	311-629	3/8"	4-3/4"	.045"
311-627	7/32"	2-1/4"	.034"	311-631	3/8"	11"	.054"
311-617	1/4"	1-1/8"	.020"	311-626	7/16"	3-1/8"	.041"
311-624	1/4"	3-3/4"	.034"	311-606	7/16"	5"	.062"
311-609	1/4"	4"	.028"	311-661	7/16"	6-3/8"	.054"
311-607	1/4"	5-3/4"	.028"	311-605	7/16"	6-1/2"	.041"
311-635	9/32"	1-1/8"	.020"	311-611	1/2"	4-1/2"	.062"
311-628	9/32"	1-7/8"	.034"	311-604	1/2"	5-1/2"	.080"
311-625	5/16"	2-1/2"	.034"	311-632	1/2"	11"	.062"

UTILITY SPRING ASSORTMENTS ASSORTIMENTS DE RESSORT D'UTILITÉ

GARAGE ASSORTMENT

No. 020-063

Contains 100 Small Coil Springs. Compression and Extension types included. Packed in plastic box.

020-063



UTILITY ASSORTMENT

No. 020-342

Contains 83 Extension and Compression Springs
15 Popular Sizes.
Packed in a sturdy fibreboard container.

020-342



MASTER ASSORTMENT

No. 020-637

Contains 135 Utility Springs, consisting of Compression, Extension and Ignition Springs. With this Assortment you will find a spring suitable for most any replacement. The attractive label shows the dimensions, stock number and list price of each spring. Refills may be ordered from standard stock.

Assortment is packed in a sturdy, sectional metal container complete with self-locking handle.

020-637



EXTENSION SPRING ASSORTMENT

No. 020-860

Contains 30 Extension Springs. 12 popular sizes.

020-860



COMPRESSION SPRING ASSORTMENT

No. 020-861

Contains 40 Compression Springs. 12 popular sizes.

020-861



BRASS SHIM STOCK FEUILLES POUR CALE LAITON

305
Series

Papco[®] Brass Shim Stock is uniform and accurate in thickness, hard temper and is ideal for cutting and shaping. The 6" wide x 100" long rolls are supplied in fibre dispenser tubes for easy use.

ORDER BY STOCK NUMBER

Stock No.	Thickness	Stock No.	Thickness
100 Inch Strips			
305-601	.001	305-608	.008
305-602	.002	305-609	.009
305-603	.003	305-610	.010
305-604	.004	305-612	.012
305-605	.005	305-615	.015
305-606	.006	305-620	.020
305-607	.007	305-625	.025



STEEL SHIM STOCK FEUILLES POUR CALE ACIER

305
Series

Papco[®] Steel Shim Stock is hard shim temper and uniform in thickness. Supplied in strips 100 inches long by 6 inches wide as listed. Each strip is packed in a sturdy fibre tube.

ORDER BY STOCK NUMBER

Stock No.	Thickness	Stock No.	Thickness	Stock No.	Thickness	Stock No.	Thickness
6" Wide by 100" Long							
306-601	.001	306-604	.004	306-607	.007	306-612	.012
306-602	.002	306-605	.005	306-608	.008	306-615	.015
306-603	.003	306-606	.006	306-610	.010	306-620	.020

Note: Stainless Steel Shim Stock available – price on application.



SNAP FASTENERS ATTACHES 'SNAP'

400
Series

Durable Fasteners

Papco® Snap Fasteners provide superior snap action and holding strength. Snap Fasteners are self-piercing and made of heavy duty, nickel plated brass. Used in a variety of materials on boats, tents, sporting goods, RV's, luggage, awnings, clothing - camper, convertible and tonneau tops.

ORDER BY STOCK NUMBER

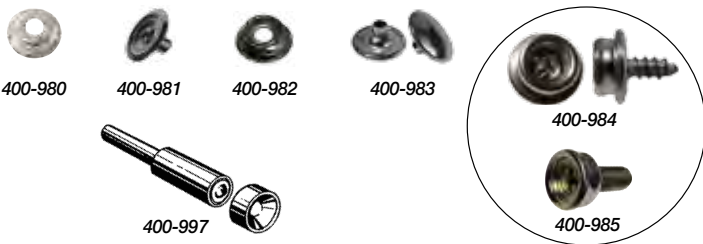
Stock No.	Description	Standard Package					
400-980	3/8 Socket - Normal Action	25	400-980	400-981	400-982	400-983	400-984
400-981	3/8 Post - 10 mm dia.	25					
400-982	3/8 Stud	25					
400-983	3/8 Cap 24 mm dia.	25					
400-984	3/8 Screw Stud No. 8	25					
400-985	3/8 Bolt Stud 10-32	25					
400-997	Installation Tool	1					

'LIFT-THE-DOT' FASTENERS ATTACHES 'LIFT-THE-DOT'

Strong, heavy duty fasteners that lock on 3 sides. Opened by lifting the fourth side where the dot and trademark appear.

ORDER BY STOCK NUMBER

Stock No.	Description	Standard Package					
400-900	No. 8 Wood Screw Stud	25	400-903	400-913	400-900	400-902	400-904
400-902	Stud	25					
400-903	Socket	25					
400-904	Washer	25					
400-913	Back Plate	25					

TURN FASTENERS ATTACHES TOURNANTES

Also known as Common Sense Fasteners

Papco® Turn Fasteners are positive locking and never open accidentally. Spring mechanism contained in stud holds fastener under tension until turned by hand.

ORDER BY STOCK NUMBER

Stock No.	Description	Standard Package					
400-901	Turn Button	10	400-912	400-911	400-901	400-905	400-910
400-905	Back Plate	25					
400-910	Turn Button	10					
400-911	Washer	25					
400-912	Grommet	25					

GARAGE ASSORTMENT

No. 020-091

Contains 25 pieces including installation tool of the most popular Snap Fasteners packed in a sturdy, transparent box.

No. 020-092

Contains 20 pieces of Lift-the-Dot[®] Fasteners in a clear, compartmentalized plastic box.

No. 020-093

Contains 20 pieces of Papco[®] Turn Fasteners packed in a clear, plastic container with hinged lid.



BRASS GROMMETS BAGUES EN LATION

400
Series

Solid Brass, tooth type grommets are recommended for extra holding power and corrosion resistance. Use grommets on tents, tarpaulins, trucks, sails, awnings, boat covers, pool covers, lawn furniture etc. Available in two sizes: No. 400-958 3/8" I.D. and No. 400-960 1/2" I.D. Order by stock number. Standard package 10 pieces per bag.



3/8" GROMMET KIT

No. 400-968

Consists of hole punch, flaring punch and anvil base. Includes 10 solid Brass 3/8" grommets with tooth type washers. Packed with instructions in a re-usable hang-up vinyl pouch. Professional quality tool kit.



1/2" GROMMET KIT

No. 400-970

Professional setting tool and ten 1/2" grommets as above.



**CERAMIC MAGNETS
AIMANTS CÉRAMIQUES**

Papco[®] High Strength Ceramic Magnets are ideal for temporary attachment of metal panels, work orders or masking material without damaging painted areas or other metal surfaces.

CERAMIC BLOCK MAGNETS

Stock No.	Width	Length	Height	Package
400-002	7/8	1-7/8	3/8	2

400-002



CERAMIC DISC MAGNETS

Stock No.	Diameter	Height	Package
400-004	1/2	3/16	10
400-005	3/4	3/8	8

400-005



**MAGNETIC STRIP
BANDE AIMANTE**

No. 400-010

Flexible, Magnetic Strip with adhesive back, cuts easily with scissors or a knife. Magnetic surface of strip holds small metal objects. Ideal for Body Shops for holding plastic masking material or work orders to vehicle body areas without damaging painted surfaces. Perfect for mounting signs.

Size: 1/2" wide x 10 feet long. Order by stock number.

400-010



**LIFTING MAGNET (HEAVY DUTY)
AIMANT RÉCUPERATEUR (USAGE INTENSE)**

USAGE INTENSE

No. 400-020

For commercial, recreational or household use. Ideal for removing dents in metal. Retrieve submerged tools, metal parts, tackle, fishing poles etc. Locate, lift, hold or hang steel articles. Order by stock number.

Individually packaged.

Lifts up to 150 lbs

400-020



**TOOL MAGNETIZER / DEMAGNETIZER
OUTIL À AIMANTER / DÉ-AIMANTER**

No. 400-022

Easy-to-use tool magnetizes screwdrivers, wrenches and other small tools. Pass tool through centre hole of charger to magnetize. To demagnetize pass tool over outside edge of charger several times. Order by stock number.

400-022

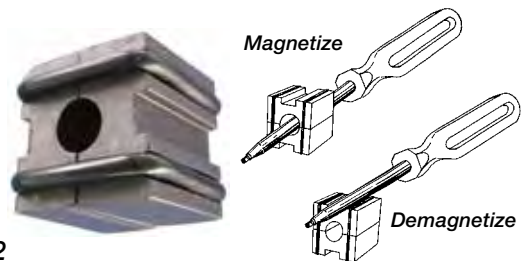

**MAGNETIC RETRIEVER
RAMASSE-PIÈCES AIMANTE**

No. 400-024

This chrome plated, telescopic tool has a powerful, permanent NEODYMIUM magnetic tip that will lift over 3.5 pounds. The retriever can be used to pick-up steel objects, dropped tools, fasteners etc. from hard-to-reach places. Six inches long with a handy pocket clip, extends to over 24". Can also be used as a presentation pointer. Order by stock number. Individually carded.

400-024



VACUUM CONNECTORS RACCORDS À DÉPRESSION

904 Series

Papco® Plastic Fittings are designed for quick, easy, inexpensive installations of vacuum lines, windshield washer lines and any other low pressure systems using air or fluids. Can be used with all flexible plastic tubing. Not recommended for fuel line applications.

ORDER BY STOCK NUMBER

Nylon Straight Connector



Stock No.	Tube Size
904-901	1/8 x 1/8
904-902	3/16 x 3/16
904-903	1/4 x 1/4
904-904	5/16 x 5/16
904-905	3/8 x 3/8

Nylon Reducing Straight Connector



Stock No.	Tube Size
904-911	1/8 x 3/16
904-912	1/8 x 1/4
904-913	3/16 x 1/4
904-914	1/4 x 3/8

Nylon Restrictor Connector



Stock No.	Tube Size
940-920	3/16 x 3/16

Nylon 3 Way Tee

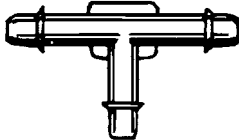

Stock No.	Tube Size
904-922	1/8 x 1/8 x 1/8
904-923	3/16 x 3/16 x 3/16
904-924	1/4 x 1/4 x 1/4
904-925	5/16 x 5/16 x 5/16
904-926	3/8 x 3/8 x 3/8

Nylon 3 Way Reducing Tee

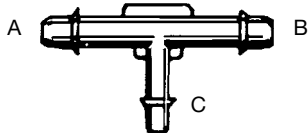

Stock No.	Tube Size 'A' x 'B' x 'C'
904-929	1/8 x 1/8 x 3/16
904-930	1/8 x 1/8 x 1/4
904-931	3/16 x 1/8 x 3/16
904-932	3/16 x 1/4 x 3/16
904-933	3/16 x 3/16 x 1/8
904-934	1/4 x 3/16 x 3/16
904-938*	1/4 x 3/8 x 3/8
904-939	3/8 x 3/8 x 1/4

*PCV Connector

Nylon 'Y' Connector

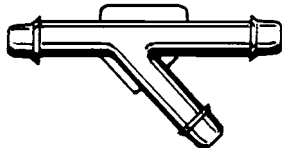

Stock No.	Tube Size
904-940	1/8 x 1/8 x 1/8
904-941	3/16 x 3/16 x 3/16
904-942	1/4 x 1/4 x 1/4
904-943	5/16 x 5/16 x 5/16

Nylon Reducing 'Y' Connector

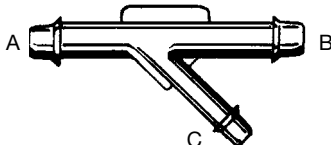

Stock No.	Tube Size 'A' x 'B' x 'C'
904-944	1/4 x 1/4 x 3/16

Nylon 90° Elbow

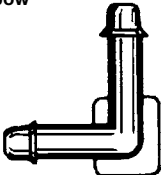

Stock No.	Tube Size x Pipe Size
940-950	1/8 x 1/8
940-951	3/16 x 3/16
940-952	1/4 x 1/4
940-953	5/16 x 5/16

Nylon 4 Way Connector

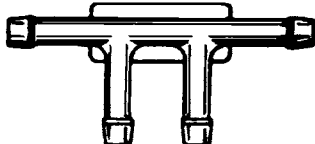

Stock No.	Tube Size
904-960	3/16

Nylon 5 Way Connector



Stock No.	Tube Size
904-965	3/16

For **MASTER ASSORTMENT** No. 020-605 of Vacuum Connectors please refer to page 7.

Standard Package: 25 Pieces

ABS Plastic Universal Tee

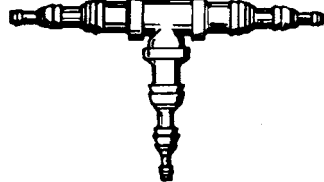

Stock No.	Tube Size
904-975	5/32 to 1/4 to 3/8

ABS Plastic Universal Straight Connector



Stock No.	Tube size
904-976	5/32 to 1/4 to 3/8

Vacuum Caps



Stock No.	Hose Size
904-990	1/8
904-991	3/16
904-992	1/4
904-993	5/16
904-994	3/8

Soft Rubber Vacuum Tee

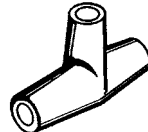

Stock No.	Hose Size
904-985	7/64 x 7/67 x 7/64

Soft Rubber Vacuum Connectors

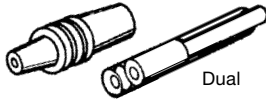

Stock No.	Tube Size
904-986	5/32 Dual
904-987	1/8 x 5/32

Soft Rubber Vacuum Elbow and Hose

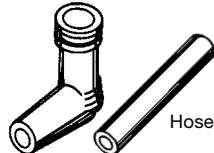

Stock No.	Hose Size
904-988	5/32 x 3/16
904-989	5/32 x 2" Hose

TAPS & DIES TARAUDS & FILIÈRES

Papco® Taps and Dies are made of high carbon tool Steel, heat treated to industrial specifications and packed in colour-coded, protective packs. Long-life, plug type taps are chamfered for easy starting and cut clean accurate threads. Hexagon dies in sizes to 1/2" and M12 are 1" across flats - larger sizes are 1-7/16" across flats. Use Die Stock No. 996-563 or wrench for driving dies. Papco® Taps and Dies are available in NC (National Coarse), NF (National Fine); Metric Standard, Fine and Extra Fine thread pitch - plus N.P.T. (National Pipe Thread) and B.S.P. (British Standard Pipe) for fittings on Import vehicles. Tap and drill sizes are engraved on each tap - starting side and size engraved on dies.

HIGH CARBON STEEL INDUSTRIAL GRADE TAPS AND DIES

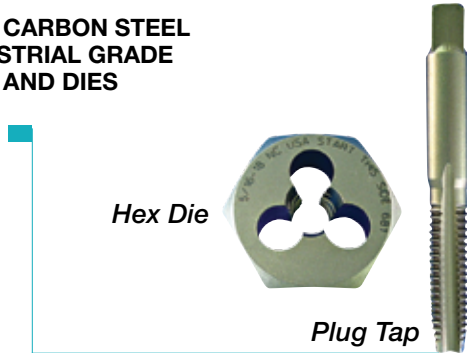

MERCHANDISERS

Nos. 022-108
022-109
022-110



NC/NF MERCHANDISER

No. 022-108

As illustrated. Contains one each of 1/4 to 1/2 Coarse and Fine Thread Taps and Dies - 20 sizes. Includes wire rack, header sign and label strips.

METRIC MERCHANDISER

No. 022-109

Contains one each of all listed sizes of Metric Standard, Fine and Extra Fine thread pitch Taps and Dies - 18 sizes. Includes wire rack, header sign and label strips.

MERCHANDISER

No. 022-110

Contains one each of NPT and BSP Taps and Dies, No. 1 to 5 Screw Extractors, Screw Extractor Set, Inch and Metric Thread Pitch Gauges and a professional Tap and Reamer Wrench. Includes pegboard hooks, header sign and planogram.

PAPCO® HIGH CARBON STEEL, PLUG TYPE TAPS

ORDER BY STOCK NUMBER

022-108						022-109			022-110		
Stock No.	Size	Drill	Stock No.	Size	Drill	Stock No.	Size	Drill	Stock No.	Size	Drill
NC National Coarse			NF National Fine			Metric			Pipe		
996-010	10-24	5/32	996-110	10-32	5/32	996-204	M4 x .7	1/8	996-250	1/8-27 NPT	11/32
996-014	1/4-20	13/64	996-114	1/4-28	7/32	996-205	M5 x .8	11/64	996-252	1/4-18 NPT	7/16
996-016	5/16-18	17/64	996-116	5/16-24	17/64	996-206	M6 x 1.0	13/64	996-254	3/8-18 NPT	37/64
996-018	3/8-16	5/16	996-118	3/8-24	21/64	996-208	M8 x 1.25	17/64	996-256	1/2-14 NPT	23/32
996-020	7/16-14	3/8	996-120	7/16-20	25/64	996-210	M10 x 1.5	11/32	996-257	1/8-28 BS	5/16
996-022	1/2-13	27/64	996-122	1/2-20	29/64	996-212	M12 x 1.75	27/64			
						996-230	M8 x 1.0 F	9/32			
						996-231	M10 x 1.25 F	11/32			
						996-232	M12 x 1.5 F	13/32			
						996-240	M10 x 1.0 XF	23/64			

F - Fine Thread Pitch
XF - Extra Fine Thread (Spark Plug)

PAPCO® HIGH CARBON STEEL, HEXAGON DIES (1 AF)

ORDER BY STOCK NUMBER

022-108				022-109		022-110	
Stock No.	Size	Stock No.	Size	Stock No.	Size	Stock No.	Size
NC National Coarse		NF National Fine		Metric		Pipe	
996-314	1/4-20	996-414	1/4-28	996-505	M5 x .8	996-540	1/8-27 NPT
996-316	5/16-18	996-416	5/16-24	996-506	M6 x 1.0	996-542	1/4-18 NPT
996-318	3/8-16	996-418	3/8-24	996-508	M8 x 1.25	996-547	1/8-28 NPT
996-320	7/16-14	996-420	7/16-20	996-510	M10 x 1.5	996-550	Screw Extractor Set
996-322	1/2-13	996-422	1/2-20	996-512	M12 x 1.75	996-551	Straight Flute Screw Extractor
				996-530	M8 x 1.0 F	996-552	Straight Flute Screw Extractor
				996-531	M10 x 1.25 XF	996-553	Straight Flute Screw Extractor
				996-532	M12 x 1.5 F	996-554	Straight Flute Screw Extractor
						996-555	Straight Flute Screw Extractor
						996-570	Inch Screw Pitch Gauge
						996-571	Metric Screw

(* 1-7/16 AF)
F - Fine Thread Pitch

THREAD CUTTING TOOLS AND MERCHANDISERS PRÉSENTOIRS ET OUTILS AUTO-TARAUDEUSES

SCREW EXTRACTORS

These chrome-vanadium straight flute extractors are heat treated to give the highest torque specification and may be used with any wrench. Straight tapered flute will not expand the screw or stud being removed. Drill size engraved on each individually packed extractor.

ORDER BY STOCK NUMBER

Stock No.	Size	Fits Screw Dia.	Use Drill
996-551	No. 1	1/4, 5/16, M6, M8	1/8
996-552	No. 2	3/8, M10, 1/8-27, 1/8-28	3/16
996-553	No. 3*	7/16, M12	15/64
996-554	No. 4	1/2, 9/16, M14, 1/4-18	5/16
996-555	No. 5	5/8, M16, 3/8-18	3/8

*Use for broken Grease Fittings



SCREW EXTRACTORS SET

No. 996-550

Consists of five extractors
- One each of No. 1 to 5
as listed above.



996-550

TOOLS OUTILS

'T'- HANDLE TAP WRENCH

No. 996-560

Fits taps from No. 0 to 1/4"
and features adjustable,
self-equalizing wrench
jaws. Handle is held in
place by spring tension.
Individually carded.



996-560

'T'- HANDLE TAP WRENCH

No. 996-561

Fits 1/4" to 1/2"
taps. Features a removable
handle-plus a 3/8"
female square drive for
extensions or ratchet
drive. Individually carded.



996-561

PROFESSIONAL TAP WRENCH

No. 996-562

Fits taps from M4 to 1/2".
Industrial quality tool is
used for taps, reamers
and screw extractors.
Adjustable, hardened jaws
tighten by turning handles.
Individually carded.



996-562

DIE STOCK

No. 996-563

Professional Die Holder
fits 1" hexagon or round
dies up to 1/2" or M12.
Has three jaw, self-
centering, adjustable
guides for easy starting
and accurate threading.
Chrome plated handles.
Individually carded.



996-563

SCREW PITCH GAUGES

No. 996-570 (Inch)

For inch threads. 14 blades for threads from 10 to 40 per inch. Individually packaged. (Inch 'pitch' is the number of threads per inch T.P.I.)

No. 996-571 (Metric)

For metric threads. 14 blades for pitches from 0.45 to 2.50 mm. Individually packaged. (Metric 'pitch' is the distance between threads.)



996-570



996-571

HIGH SPEED STEEL INDUSTRIAL GRADE DRILL BITS FORETS ACIER RAPIDE QUALITÉ INDUSTRIELS

These jobber length high speed tool steel drill bits feature a ground body and polished flutes for fast chip removal. Suitable for drilling steel, wood and plastic. Bits are packaged on bar-coded hang-up cards individually (* 2 bits).

DRILL BIT MERCHANDISER

No. 022-115

Contains each of the 29 sizes of drill bits from 1/16" to 1/2" by 64th., including 3/8" reduced shanks, 1/4" to 1/2" Masonry Bits - and 1/8" double-ended panel drills. A total of 82 cards including an attractive header sign and merchandising rack suitable for wall, pegboard, counter, or gondola display.



1/8" DOUBLE ENDED PANEL DRILL

No. 997-594

High speed ground steel with special 135° split point. Made for body panel work. Starts cutting on contact, won't wander, no centre punch required. 1/8" Dia. x 2" long double-ended. Packed 5 bits per pouch.



997-120

997-594

ORDER BY STOCK NUMBER

Stock No.	Diameter	Length Overall	Stock No.	Diameter	Length Overall	Stock No.	Diameter	Length Overall
High Speed Steel Drills			High Speed Steel Drills			High Speed Steel Drills		
997-104*	1/16	1-7/8	997-117	17/64	4-1/8	997-130†	15/32	5-3/4
997-105*	5/64	2	997-118	9/32	4-1/4	997-131†	31/64	5-7/8
997-106*	3/32	2-1/4	997-119	19/64	4-3/8	997-132†	1/2	6
997-107*	7/64	2-5/8	997-120	5/16	4-1/2	Masonry Drills - Carbide Tip		
997-108*	1/8	2-3/4	997-121	21/64	4-5/8	997-586	3/16	3-3/8
997-109	9/64	2-7/8	997-122	11/32	4-3/4	997-587	1/4	4
997-110	5/32	3-1/8	997-123	23/64	4-7/8	997-588	5/16	4-3/4
997-111	11/64	3-1/4	997-124	3/8	5	997-589	3/8	4-3/4
997-112	3/16	3-1/2	997-125†	25/64	5-1/8	997-590†	1/2	5-7/8
997-113	13/64	3-5/8	997-126†	13/32	5-1/4	997-591†	5/8	6
997-114	7/32	3-3/4	997-127†	27/64	5-3/8	997-592†	3/4	6
997-115	15/64	3-7/8	997-128†	7/16	5-1/2			
997-116	1/4	4	997-129†	29/64	5-5/8			

* These sizes 2 bits Per card.

† 3/8 Reduced Shank

**DRILL SETS
JEU DE FORETS**

HIGH SPEED STEEL INDUSTRIAL GRADE DRILL BITS



A No. 020-907

4 Pieces – 1/16, 1/8, 3/16, 1/4 H.S.S. 'Pic-a-drill' clear vinyl pouch. The 4 most popular drill sizes. Ideal as a basic kit or to replace worn drills in larger sets.

B No. 020-910

10 Pieces – 1/16 to 1/4 H.S.S. 'Pic-a-drill' rigid styrene case hangs or stands on workbench. Each drill in a separate compartment. Good size coverage in a handy box. 1/16, 5/64, 3/32, 7/64, 1/8, 9/64, 5/32, 3/16, 7/32, 1/4.

C No. 020-913

13 Pieces – 1/16 to 1/4 H.S.S. 'Pic-a-drill' revolving case. 13 popular sizes in a new design rotating case. Dial each size as needed. 1/16, 5/64, 3/32, 7/64, 1/8, 9/64, 5/32, 11/64, 3/16, 13/64, 7/32, 15/64, 1/4.

D No. 020-914

14 Pieces – 1/16 to 1/2 with shanks reduced to 3/8. 'Pic-a-drill' strong folding polypropylene case holds and protects this fine set. 1/16, 5/64, 3/32, 7/64, 1/8, 9/64, 5/32, 3/16, 7/32, 1/4, 5/16, 3/8, and 7/16, 1/2, with 3/8 reduced shanks.

E No. 020-921

21 pieces – 1/16 to 3/8 by 64ths. H.S.S. A complete range of sizes for all requirements. 'Pic-a-drill' revolving case has clear rotating top for fast selection. Drill sizes clearly indexed.

F No. 022-114

A balanced stock of 14 'Pic-a-drill' sets. 6 No. 020-907, 3 No. 020-910, 2 No. 020-913, 2 No. 020-914 and 1 No. 020-921. Includes header sign and merchandising rack. Suitable for wall, pegboard, counter or gondola display. Size: 16" W x 14" H (Illustrated below.)



PERMA-THREAD®



PERMA-THREAD® HELICALLY COILED INSERTS

PERMA-PLUG SPARK PLUG REPAIR KIT

**PERMA-THREAD[®] HELICALLY COILED INSERTS
INSERTIONS HÉLICOÏDAUX PERMA-THREAD[®]**

Repair defective, stripped or damaged threads quickly and permanently. These inserts are made of diamond shaped stainless steel wire formed into a spiral screw thread coil.

They form a thread which is stronger than the original tapped material. The resilient quality of the insert allows it to adjust to eliminate stress concentration. The Perma-Thread[®] insert restores the hole to its initial size – a bolt or screw of the original size can be used for reassembly.

Full instructions for using the Perma-Thread[®] inserts are provided in each Repair Kit.

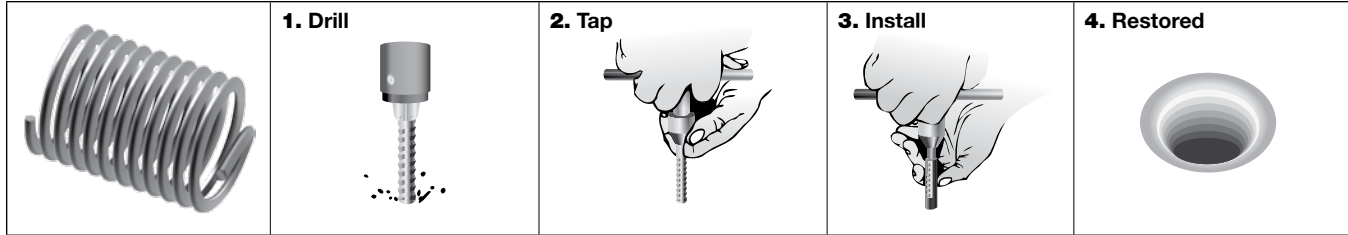

**THREAD REPAIR
MASTER ASSORTMENT**

No. 020-631

Includes contents of one Repair Kit of each 10-24, 1/4-20, 5/16-18, 3/8-16, 7/16-14, 1/2-13 and 14 mm with 3/8", 7/16", 1/2" and 3/4" reach.



THREAD REPAIR CENTRE

No. 1208-3

Stock the most popular Perma-Thread[®] Inserts on this colourful, metal display.

Five complete Thread Repair Kits: 1/4-20, 5/16-18, 3/8-16, 7/16-14, 1/2-13 - plus five packs of inserts. Also one 14 mm Spark Plug Kit (Tap and Tool) and three packs of plug inserts. Fourteen items plus rack.



**METRIC THREAD REPAIR
CENTRE**

No. 1221-3







Includes four Metric Thread Repair Kits: M5 x .8, M6 x 1.0, M8 x 1.25 and M10 x 1.5 - plus two Spark Plug Kits (Tap and Tool) for 12 mm and 14 mm plugs. Also four packs of plug inserts. Fourteen items plus rack.

PERMA-PLUG SPARK PLUG REPAIR KIT TROUSSE DE RÉPARATION DE BOUGIE 'PERMA-PLUG'

No. 2200-14

Includes one each of the items listed below:

Can be used with M14 x 1.25 taper seat or gasket type Spark Plugs in either aluminum or cast iron.
Easily installed without drilling – becomes a permanent repair.

<p>Tap</p>  <p>Lubricate tap. Start by hand then use socket to tap hole full depth. Clean chips from hole.</p>	<p>Piloted Tap</p>  <p>2258-14</p>	<p>Select Insert</p>  <p>Select insert length same as threads on spark plug. Coat outside threads with hi-temp RTV silicone. Knurled end of insert should be at top of hole.</p>	<p>Inserts</p>  <p><i>Short 2214-S</i></p> <p><i>Normal 2214-N</i></p> <p><i>Long 2214-L</i></p>	<p>Install</p>  <p>Using spark plug, screw insert in until flush with spark plug hole.</p>	<p>Expanding Tool</p>  <p>2294-14</p>	<p>Repaired</p>  <p>Place tool into insert and strike several times to expand knurl and lock insert. Install plug to recommended torque. Run engine after sealant has set.</p>
--	---	--	--	---	--	--

PERMA-PLUG DISPLAY CENTRE

No. 1400-1

Contents and Replacement Parts
ORDER BY STOCK NUMBER

Stock No.	Description	Quantity
2200-14	M14 x 1.25 Perma-Plug Kit	3
2214-S	M14 x 1.25 x 3/8 Short Reach Insert	4
2214-N	M14 x 1.25 x 1/2 Normal Reach Insert	4
2214-L	M14 x 1.25 x 3/4 Long Reach Insert	4



**PERMA-THREAD® HELICALLY COILED INSERTS
INSERTIONS HÉLICOÏDAUX PERMA-THREAD®**

ORDER BY PART NUMBER

Repair Kits contain inserts, tap and installation tools. Inserts also available in standard packages.

Repair Kits



Inserts

High Speed Steel Tap

Installation Tool

Repair Kits for field or shop use.

Complete Kits: Inserts-taps-tools.

Standard Packages					Repair Kits		Taps	Tools
Size Dia. x Length	Insert Pkg Part No.	Drill Size	Qty Per Pack	Kit Stock No.	Inserts Per Kit	Tap Part No.	Tool Part No.	
Unified National Coarse								
4-40	.168	P208-014	1/8	12	1208-014	12	1428-014	1182-014
5-40	.188	P208-015	9/64	12	1208-015	12	1428-015	1182-015
6-32	.207	P208-016	5/32	12	1208-016	12	1428-016	1182-016
8-32	.246	P208-018	11/64	12	1208-018	12	1428-018	1182-018
10-24	.285	P208-101	13/64	12	1208-101	12	1428-101	1182-101
12-24	.324	P208-102	15/64	12	1208-102	12	1428-102	1182-102
1/4-20	.375	P208-104	17/64	12	1208-104	12	1428-104	1182-104
5/16-18	.469	P208-105	21/64	12	1208-105	12	1428-105	1182-105
3/8-16	.562	P208-106	25/64	12	1208-106	12	1428-106	1182-106
7/16-14	.656	P208-107	29/64	6	1208-107	6	1428-107	1182-107
1/2-13	.750	P208-108	17/32	6	1208-108	6	1428-108	1182-108
9/16-12	.844	P208-109	19/32	6	1208-109	6	1428-109	1182-109
5/8-11	.938	P208-110	21/32	6	1208-110	6	1428-110	1182-110
3/4-10	1.125	P208-112	25/32	4	1208-112	4	1428-112	1182-112
7/8-9	1.312	P108-114	29/32	1	3208-C14	6	1043-14CP3	1182-114
1-8	1.500	P108-116	1-1/32	1	3208-C16	6	1043-16CP3	1182-116
1-1/8-7	1.688	P108-118	1-5/32	1	3208-C18	5	1043-18CP3	1182-118
1-1/4-7	1.875	P108-120	1-9/32	1	3208-C20	5	1043-20CP3	1182-120
1-3/8-6	2.062	P108-122	1-13/32	1	3208-C22	4	1043-22CP3	1182-122
1-1/2-6	2.250	P108-124	1-17/32	1	3208-C24	4	1043-24CP3	1182-124
Unified National Fine								
10-32	.285	P208-201	13/64	12	1208-201	12	1428-201	1172-201
1/4-28	.375	P208-204	17/64	12	1208-204	12	1428-204	1172-204
5/16-24	.469	P208-205	21/64	12	1208-205	12	1428-205	1172-205
3/8-24	.562	P208-206	25/64	12	1208-206	12	1428-206	1172-206
7/16-20	.656	P208-207	29/64	6	1208-207	6	1428-207	1172-207
1/2-20	.750	P208-208	33/64	6	1208-208	6	1428-208	1172-208
9/16-18	.844	P208-209	37/64	6	1208-209	6	1428-209	1172-209
5/8-18	.938	P208-210	41/64	6	1208-210	6	1428-210	1172-210
3/4-16	1.125	P208-212	49/64	4	1208-212	4	1428-212	1172-212
7/8-14	1.312	P108-214	57/64	1	3208-F14	6	1043-14FP3	1039-14F
1-14	1.500	P108-2164	1-1/64	1	3208-F164	6	1043-164FP3	1039-164F
1-1/8-12	1.688	P108-218	1-5/32	1	3208-F18	5	1043-18FP3	1039-18F
1-1/4-12	1.875	P108-220	1-9/32	1	3208-F20	5	1043-20FP3	1039-20F
1-3/8-12	2.062	P108-222	1-13/32	1	3208-F22	4	1043-22FP3	1039-22F
1-1/2-12	2.250	P108-224	1-17/32	1	3208-F24	4	1043-24FP3	1039-24F
Standard Metric Series					Coarse Thread Series			
M5 x 0.8	7.5 mm	P206-305	13/64	12	1221-305	12	1448-305	1287-305
M6 x 1.0	9.0 mm	P206-306	1/4	12	1221-306	12	1448-306	1287-306
M7 x 1.0	10.5 mm	P206-307	9/32	12	1221-307	12	1448-307	1289-307
M8 x 1.25	12.0 mm	P206-308	21/64	12	1221-308	12	1448-308	1289-308
M9 x 1.25	13.5 mm	P206-309	m9.4	12	1221-309	12	1448-309	1289-309
M10 x 1.50	15.0 mm	P206-310	13/32	12	1221-310	12	1448-310	1289-310
M11 x 1.50	16.5 mm	P106-311	29/64	6	1221-311	6	1448-311	1289-311
M12 x 1.75	18.0 mm	P106-312	31/64	6	3221-M12C	6	5043-120CP4	1289-312
M14 x 2.0	21.0 mm	P106-314	37/64	6	3221-M14C	6	5043-140CP4	1289-314
M16 x 2.0	24.0 mm	P106-316	21/32	6	3221-M16C	6	5043-160CP4	1289-316
M18 x 2.5	27.0 mm	P106-318	47/64	6	3221-M18C	6	5043-180CP4	1289-318
M20 x 2.5	30.0 mm	P106-320	13/16	6	3221-M20C	6	5043-200CP4	1289-320
					Fine Thread Series			
M10 x 1.25	15.0 mm	P106-610	13/32	6	3221-M10F	6	5043-100FP4	1287-610
M11 x 1.25	16.5 mm	P106-61125	29/64	6	1221-M1125	6	1448-61125	1287-61125
M12 x 1.25	18.0 mm	P106-612	31/64	6	3221-M12F	6	5043-120FP4	1287-612
M12 x 1.5	18.0 mm	P106-61215	31/64	6	3221-M1215	6	5043-1215P4	1287-61215
M14 x 1.5	21.0 mm	P106-614	9/16	6	3221-M14F	6	5043-140FP4	1287-614
M16 x 1.5	24.0 mm	P106-616	21/32	6	3221-M16F	6	5043-160FP4	1287-616
Spark Plug Series - Do not use these inserts to repair taper seat spark plug ports								
M10 x 1.0	.500	P410-500	-	6	1210-410*	-	1458-100	1094-100
M12 x 1.25	.500	P412-500	-	6	1212-412*	-	1458-123	1094-123
M12 x 1.25	.750	P412-750	-	6	-	-	-	-
M14 x 1.25	.375	P414-375	-	6	1214-414*	-	1458-143	1094-143
M14 x 1.25	.438	P414-438	-	6	-	-	-	-
M14 x 1.25	.500	P414-500	-	6	-	-	-	-
M14 x 1.25	.750	P414-750	-	6	-	-	-	-
M18 x 1.50	.500	P418-500	-	6	1218-500	6	1458-185	1094-185
'Perma-Plug' Spark Plug Series - Can be used with taper seat or gasket type spark plugs								
M14 x 1.25	.375	2214S	-	1	-	-	-	-
M14 x 1.25	.500	2214N	-	1	2200-14	-	2258-14	2294-14
M14 x 1.25	.750	2214L	-	1	-	-	-	-

Spark Plug Series

Combination Piloted Reamer/Tap

No drilling for spark plug port repair.

1. Threaded Pilot aligns tool to correct port angle.
2. Reamer removes stripped or damaged threads.
3. Tap cuts new thread to accept Perma-Thread® insert.

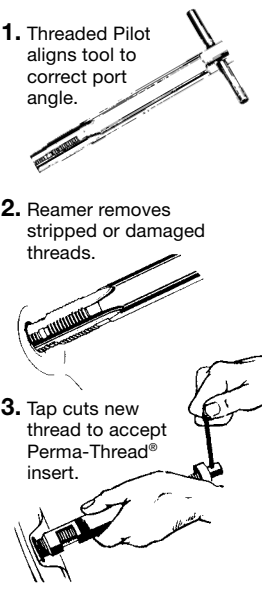

* NOTE: 10mm, 12mm and 14mm spark plug kits contain combination piloted Reamer/Tap tool and NO inserts. Same tools are applicable regardless of insert length. Purchase packs of inserts separately. Perma-Thread® Repair Kits include: Inserts, Tap, Installation Tool, Instructions unless otherwise specified.

AN INTRODUCTION TO...

STAINLESS STEEL

ACIER INOXYDABLE

...UNE INTRODUCTION.

www.hpaulin.com

For a full listing of Stainless Steel, please refer to our current catalogue or visit our website to download a PDF version.

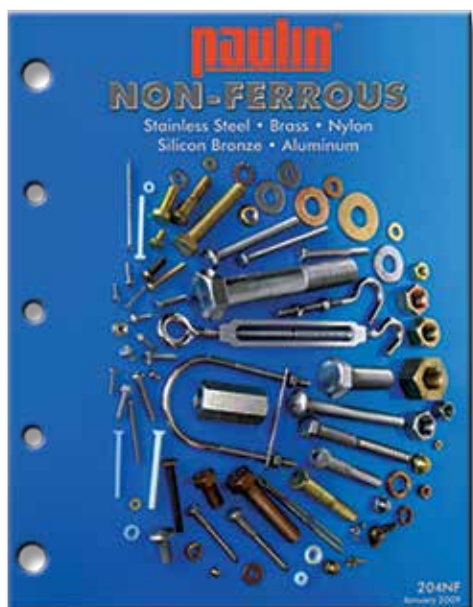

HEX BOLTS

CARRIAGE BOLTS

LAG BOLTS

SOCKET HEAD CAP SCREWS

FINISHED HEX NUTS

NYLON INSERT STOP NUTS

HEX MACHINE SCREW NUTS

WASHERS

COTTER PINS

THREADED RODS

MACHINE SCREWS



18.8 STAINLESS STEEL HEX BOLTS BOULONS HEX EN ACIER INOXYDABLE 18,8



5000 Series

Corrosion resistant Type 300 Series (18% chromium - 8% nickel). Used in marine applications, food processing equipment and wherever resistance to most acids and chemicals is required. Non-magnetic. UNC thread.

Order by stock number.

Stock No.	Size	Std. Pkg.	Stock No.	Size	Std. Pkg.	Stock No.	Size	Std. Pkg.	Stock No.	Size	Std. Pkg.
5000-307	1/4-20 x 3/4	100	5000-442	5/16-18 x 3/4	100	5000-487	3/8-16 x 3/4	100	5000-577	1/2-13 x 3/4	25
5000-309	1/4-20 x 1	100	5000-444	5/16-18 x 1	100	5000-489	3/8-16 x 1	100	5000-579	1/2-13 x 1	25
5000-313	1/4-20 x 1-1/2	100	5000-448	5/16-18 x 1-1/2	100	5000-493	3/8-16 x 1-1/2	100	5000-583	1/2-13 x 1-1/2	25
5000-316	1/4-20 x 2	100	5000-451	5/16-18 x 2	100	5000-496	3/8-16 x 2	100	5000-586	1/2-13 x 2	20
5000-318	1/4-20 x 2-1/2	50	5000-453	5/16-18 x 2-1/2	50	5000-498	3/8-16 x 2-1/2	50	5000-588	1/2-13 x 2-1/2	20
5000-320	1/4-20 x 3	25	5000-455	5/16-18 x 3	25	5000-500	3/8-16 x 3	25	5000-590	1/2-13 x 3	10

18.8 STAINLESS STEEL CARRIAGE BOLTS BOULONS DE CARROSSE ACIER INOXYDABLE 18,8

5002 Series



Order by stock number.

Stock No.	Size	Std. Pkg.	Stock No.	Size	Std. Pkg.	Stock No.	Size	Std. Pkg.
5002-309	1/4-20 x 1	100	5002-444	5/16-18 x 1	50	5002-489	3/8-16 x 1	50
5002-313	1/4-20 x 1-1/2	100	5002-448	5/16-18 x 1-1/2	50	5002-493	3/8-16 x 1-1/2	50
5002-316	1/4-20 x 2	100	5002-451	5/16-18 x 2	50	5002-496	3/8-16 x 2	25
5002-318	1/4-20 x 2-1/2	50	5002-453	5/16-18 x 2-1/2	25	5002-498	3/8-16 x 2-1/2	25
5002-320	1/4-20 x 3	50	5002-455	5/16-18 x 3	25	5002-500	3/8-16 x 3	25
5002-324	1/4-20 x 4	25	5002-459	5/16-18 x 4	25	5002-504	3/8-16 x 4	10

18.8 STAINLESS STEEL LAG BOLTS TIRE-FOND ACIER INOXYDABLE 18,8

5003 Series



Order by stock number.

Stock No.	Size	Std. Pkg.	Stock No.	Size	Std. Pkg.	Stock No.	Size	Std. Pkg.	Stock No.	Size	Std. Pkg.
5003-309	1/4-20 x 1	50	—	5/16-18 x 1	—	5003-493	3/8-16 x 1-1/2	50	5003-586	1/2-13 x 2	50
5003-313	1/4-20 x 1-1/2	50	5003-448	5/16-18 x 1-1/2	50	5003-496	3/8-16 x 2	50	5003-588	1/2-13 x 2-1/2	25
5003-316	1/4-20 x 2	50	5003-451	5/16-18 x 2	50	5003-498	3/8-16 x 2-1/2	25	5003-590	1/2-13 x 3	25
5003-318	1/4-20 x 2-1/2	25	5003-453	5/16-18 x 2-1/2	25	5003-500	3/8-16 x 3	25	5003-594	1/2-13 x 4	20
5003-320	1/4-20 x 3	25	5003-455	5/16-18 x 3	25	5003-504	3/8-16 x 4	20			
5003-324	1/4-20 x 4	20	5003-459	5/16-18 x 4	20						

18.8 STAINLESS STEEL SOCKET HEAD CAP SCREWS BOULONS DE PRESSION ACIER INOXYDABLE 18,8

5006 UNC



Order by stock number.

Stock No.	Size	Std. Pkg.	Stock No.	Size	Std. Pkg.	Stock No.	Size	Std. Pkg.	Stock No.	Size	Std. Pkg.
5006-309	1/4-20 x 1	100	5006-444	5/16-18 x 1	100	5006-489	3/8-16 x 1	100	5006-579	1/2-13 x 1	50
5006-313	1/4-20 x 1-1/2	100	5006-448	5/16-18 x 1-1/2	100	5006-493	3/8-16 x 1-1/2	100	5006-583	1/2-13 x 1-1/2	50
5006-316	1/4-20 x 2	100	5006-451	5/16-18 x 2	100	5006-496	3/8-16 x 2	50	5006-586	1/2-13 x 2	50
5006-318	1/4-20 x 2-1/2	100	5006-453	5/16-18 x 2-1/2	100	5006-498	3/8-16 x 2-1/2	50	5006-588	1/2-13 x 2-1/2	25
5006-320	1/4-20 x 3	50	5006-455	5/16-18 x 3	50	5006-500	3/8-16 x 3	50	5006-590	1/2-13 x 3	25

18.8 STAINLESS STEEL FINISHED HEX NUTS
ÉCROUS HEX ACIER INOXYDABLE 18,8

5026
Series

Order by stock number.

Stock No.	Bolt Size	Std. Pkg.
5026-014	1/4-20	100
5026-016	5/16-18	100
5026-018	3/8-16	100
5026-022	1/2-13	50



18.8 STAINLESS STEEL NYLON INSERT STOP NUTS
ÉCROUS À BLOCAGE NYLON INOXYDABLE 18,8

5034
Series

Order by stock number.

Stock No.	Bolt Size	Std. Pkg.
5034-006	6-32	100
5034-008	8-32	100
5034-010	10-24	100
5034-011	10-32	100
5034-014	1/4-20	100
5034-016	5/16-18	100
5034-018	3/8-16	100
5034-022	1/2-13	50



18.8 STAINLESS STEEL HEX MACHINE SCREW NUTS
ÉCROUS POUR VIS DE MÉCANIQUE ACIER INOXYDABLE 18,8

5035
Series

Order by stock number.

Stock No.	Bolt Size	Std. Pkg.
5035-006	6-32	100
5035-008	8-32	100
5035-010	10-24	100
5035-014	1/4-20	100



For a complete listing of non-ferrous and stainless fasteners see separate Papco[®] Corrosion Resistant Catalogue.

18.8 STAINLESS STEEL WASHER
RONDELLES ACIER INOXYDABLE 18,8

5055
Series

18.8 Flat Washers

Order by stock number.

Stock No.	Bolt Size	I.D.	O.D.	Thickness	Std. Pkg.
5055-206	No. 6	.156	3/8	.031	100
5055-208	No. 8	.174	3/8	.031	100
5055-210	No. 10	.203	7/16	.031	100
5055-214	1/4	.281	5/8	.050	100
5055-216	5/16	.345	3/4	.050	100
5055-218	3/8	.406	7/8	.050	100
5055-222	1/2	.531	1-1/4	.062	50



5056
Series

18.8 Finishing Washers

Order by stock number.

Stock No.	Screw Size	Std. Pkg.
5056-971	No. 6	100
5056-973	No. 8	100
5056-975	No. 10	100
5056-979	1/4	100



5057
Series

18.8 Fender Washers

Order by stock number.

Stock No.	Bolt Size	O.D.	Std. Pkg.
5057-394	No. 10	1	100
5057-395	1/4	1-1/4	100
5057-396	5/16	1-1/2	100
5057-398	3/8	1-1/2	100
5057-400	1/2	2	50



5058
Series

18.8 Regular Lock Washers

Order by stock number.

Stock No.	Bolt Size	Std. Pkg.
5058-014	1/4	100
5058-016	5/16	100
5058-018	3/8	100
5058-022	1/2	100



**18.8 STAINLESS COTTER PINS
GOUPILLES ACIER INOXYDABLE 18,8**

5080
Series



Order by stock number.

Stock No.	Size	Std. Pkg.
5080-091	3/32 x 1	100
5080-095	3/32 x 1-1/2	100
5080-141	1/8 x 1	100
5080-145	1/8 x 1-1/2	100
5080-148	1/8 x 2	100
5080-171	5/32 x 1-1/2	100
5080-174	5/32 x 2	100

**18.8 STAINLESS STEEL THREADED ROD
TIGES FILETÉES ACIER INOXYDABLE 18,8**

5091
Series



Std. Pkg. as required.

Order by stock number.

Stock No.	Size	Stock No.	Size
5091-310	10-24 x 36"	5091-354	1/4-20 x 72"
5091-314	1/4-20 x 36"	5091-356	5/16-18 x 72"
5091-316	5/16-18 x 36"	5091-358	3/8-16 x 72"
5091-318	3/8-16 x 36"	5091-362	1/2-13 x 72"
5091-322	1/2-13 x 36"	5091-364	5/8-11 x 72"
5091-324	5/8-11 x 36"	5091-366	3/4-10 x 72"
5091-326	3/4-10 X36"		

Note: Fine Thread 36" long Threaded Rods are available – price on application.

**18.8 STAINLESS MACHINE SCREWS
VIS DE MÉCANIQUE INOXYDABLE 18,8**

5113
OVAL



5114
PAN

PHILLIPS

Order by stock number.

Stock No.	Size	Std. Pkg.
5113-087	5114-087 6-32 x 1/2	100
5113-091	5114-091 6-32 x 1	100
5113-141	5114-141 8-32 x 1	100
5113-193	5114-193 10-24 x 1	100
5113-197	5114-197 10-24 x 1-1/2	100
5113-200	5114-200 10-24 x 2	100
5113-313	5114-313 1/4-20 x 1-1/2	100
5113-316	5114-316 1/4-20 x 2	100

**18.8 STAINLESS TAPPING SCREWS
VIS TARAUEUSES INOXYDABLE 18,8**

5162
Series



SQUARE DRIVE

Order by stock number.

Stock No.	Size	Std. Pkg.
5162-089	6 x 3/4	100
5162-139	8 x 3/4	100
5162-141	8 x 1	100
5162-193	10 x 1	100
5162-195	10 x 1-1/4	100
5162-197	10 x 1-1/2	100
5162-254	12 x 1-1/2	100

**18.8 STAINLESS TAPPING SCREWS - TYPE A
VIS TARAUEUSES INOXYDABLE 18,8**

5163
PAN



5165
OVAL

Order by stock number.

Stock No.	Size	Std. Pkg.
5163-043	5165-043 4 x 1/2	100
5163-089	5165-089 6 x 3/4	100
5163-091	5165-091 6 x 1	100
5163-139	5165-139 8 x 3/4	100
5163-141	5165-141 8 x 1	100
5163-191	5165-191 10 x 3/4	100
5163-193	5165-193 10 x 1	100

18.8 STAINLESS STEEL 6-LOBE TRIM SCREWS VIS FINITION À SIX PANS ACIER INOXYDABLE 18,8

231
Series



CHROME PLATED

OVAL 6-LOBE HEAD 18.8 STAINLESS		
Part No.	Dia x Length	Qty.
231-205	4.2 x 20 mm	25
231-209	4.2 x 30 mm	25
231-213	4.2 x 40 mm	25
231-219	4.2 x 55 mm	25

BLACK OXIDE

OVAL 6-LOBE HEAD 18.8 STAINLESS		
Part No.	Dia x Length	Qty.
231-206	4.2 x 20 mm	25
231-210	4.2 x 30 mm	25



CHROME PLATED

PAN 6-LOBE HEAD 18.8 STAINLESS		
Part No.	Dia x Length	Qty.
231-251	4.2 x 20 mm	25
231-257	4.2 x 35 mm	25

BLACK OXIDE

PAN 6-LOBE HEAD 18.8 STAINLESS		
Part No.	Dia x Length	Qty.
231-252	4.2 x 20 mm	25
231-264	4.2 x 50 mm	25

STAINLESS GARAGE ASSORTMENT ASSORTIMENT DE GARAGE INOXYDABLE

No. 020-212

Contains 110 pieces - 8 sizes of Pan and Oval Socket 18.8 Stainless Steel Tapping Screws and 2 sizes of 18.8 Stainless Finishing Washers packed in a transparent plastic box.



020-212

MARINE FASTENERS MASTER ASSORTMENT ASSORTIMENT GÉNÉRAL D'ATTACHES MARIN

This Master Assortment is ideal for the boat owner for attaching railings, brackets, swivels, posts and other marine equipment and accessories. Each product is fully illustrated on the price coded lid label. Excellent for self-serve sales. Metal box with high-strength, moulded plastic compartments and safety locking lid.

No. 020-673

Contains 20 sizes of Stainless Steel Tapping Screws, Wood Screws, Machine Screws, Nuts and Finishing Washers.



020-673

PLASTIC ASSORTMENT KITS ASSORTIMENTS DE PLASTIQUE

No. 021-600

S.S. MARINE KIT #1 BOLTS, NUTS & WASHERS

Contains 514 pieces, 3 types of bolts, 4 types of nuts and 3 types of washers.



021-600

No. 021-601

S.S. MARINE KIT #2 SCREWS, WASHERS & BITS

Contains 648 pieces, 3 types of screws, 2 types of driver bits and washers.



021-601

For more information on Plastic Assortment S.S. Marine Kits No. 021-600 & No. 021-601 please refer to pages 9 & 12.

AN INTRODUCTION TO...

BRAKE LINES TUBULURES DE FREIN

...UNE INTRODUCTION.

www.hpaulin.com

For a full listing of Papco Flex® Lines, Adaptors, Fittings and Tools, please refer to our current catalogue or visit our website to download a PDF version.

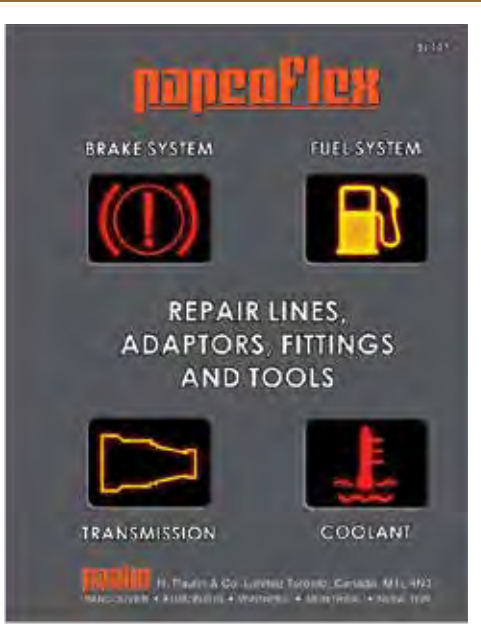

HYDRAULIC BRAKE LINES

BRAKE LINE MERCHANDISERS

BRAKE LINE TUBING

HYDRAULIC BRAKE FITTINGS

BRAKE LINE FITTINGS

BRAKE BLEEDER SCREWS

HYDRAULIC GREASE FITTINGS





**STEEL HYDRAULIC BRAKE LINES
TUBULURE DE FREIN HYDRAULIQUE**

Papcoflex Steel Hydraulic Brake Lines are ideal replacement parts for hydraulic brake, transmission, gas, oil and vacuum lines used on all cars, trucks, buses and tractors.

1. All Papco Brake Lines feature a copper brazed, double-walled steel construction coupled with a zinc outer coating that provides resistance to rust, leakage, pressure and vibration.
2. Papco lines comply to GM123M-ASV and S.A.E. J527B, have wall thickness of 0.028" (0.70mm) and withstands pressures to 17,000 psi.
3. All Papco lines can easily be shaped by hand to duplicate the original without crimping or collapsing.

Papcoflex **POLY-V Coated Brake Lines** feature a polyvinyl flouride coating to resist corrosion, nicks and dents while providing up to 30 times the protection of standard steel brake lines.

Papcoflex **Armoured Steel Brake Lines** feature the highest degree of protection against common road hazards. Each steel line is wound the entire length with a 0.046" diameter high carbon, galvanized wire and comes complete with flared fittings.

CUPRO-NICKEL Tubing Brake Lines are guaranteed for the life of the vehicle and afford the ultimate resistance to corrosion. Easiest to bend and flare. Guarantee is limited to the replacement of the product under normal wear and tear circumstances and the proper preparation (flaring) of the lines and installation.



S - STEEL P - POLY-V AS - ARMoured STEEL CN - COPPER NICKEL

ORDER BY STOCK NUMBER

Overall Length	3/16 O.D.				1/4 O.D.				5/16 O.D.				3/8 O.D.			
	S	P	AS	CN	S	P	AS	CN	S	P	AS	CN	S	P	AS	CN
6"	S-306	-	AS-306	-	-	-	-	-	-	-	-	-	-	-	-	-
8"	S-308	PS-308	AS-308	CN-308	S-408	PS-408	AS-408	CN-408	S-508	PS-508	AS-508	CN-508	S-608	PS-608	-	CN-608
10"	S-310	-	AS-310	-	S-410	-	-	-	S-510	PS-510	AS-510	-	S-610	-	AS-610	-
12"	S-312	PS-312	AS-312	CN-312	S-412	PS-412	AS-412	CN-412	S-512	PS-512	AS-512	CN-512	S-612	PS-612	AS-612	CN-612
20"	S-320	PS-320	AS-320	CN-320	S-420	PS-420	AS-420	CN-420	S-520	PS-520	AS-520	CN-520	S-620	PS-620	AS-620	CN-620
30"	S-330	PS-330	AS-330	CN-330	S-430	PS-430	AS-430	CN-430	S-530	PS-530	AS-530	CN-530	S-630	PS-630	AS-630	CN-630
40"	S-340	PS-340	AS-340	CN-340	S-440	PS-440	AS-440	CN-440	S-540	PS-540	AS-540	CN-540	S-640	PS-640	AS-640	CN-640
51"	S-351	PS-351	AS-351	CN-351	S-451	PS-451	AS-451	CN-451	S-551	PS-551	AS-551	CN-551	S-651	PS-651	AS-651	CN-651
60"	S-360	PS-360	AS-360	CN-360	S-460	PS-460	AS-460	CN-460	S-560	PS-560	AS-560	CN-560	S-660	PS-660	AS-660	CN-660
72"	S-372	PS-372	AS-372	CN-372	S-472	PS-472	AS-472	CN-472	S-572	PS-572	AS-572	CN-572	S-672	PS-672	AS-672	CN-672

METRIC BRAKE LINES

All the proven features of the Papcoflex Steel Hydraulic Brake Line. Available in three types, all 3/16" diameter and in popular lengths as listed.

Type 'A': Metric Thread with standard flare. For Nissan, Honda, Mazda and Toyota.

Type 'B': U.S. Thread with bubble flare. For Austin, Cortina, Cricket, Fiat, Jaguar, M.G. and Triumph.

Type 'C': Metric Thread with bubble flare. For BMW, Citroen, Mercedes-Benz, Peugeot, Porsche, VW.

S - STEEL P - POLY-V CN - COPPER NICKEL

ORDER BY STOCK NUMBER

Overall Length	TYPE 'A'			TYPE 'B'			TYPE 'C'			TYPE 'T'		6.0 mm O.D. GM / IMPORTS	
	S	P	CN	S	P	CN	S	P	CN	S	CN	S	CN
8"	MA308	PMA-308	CNMA-308	MB308	PMB-308	CNMB-308	MC308	PMC-308	CNMC-308	MT308	CNMT-308	MM308	CNMM-308
12"	MA312	PMA-312	CNMA-312	MB312	PMB-312	CNMB-312	MC312	PMC-312	CNMC-312	MT312	CNMT-312	MM312	CNMM-312
20"	MA320	PMA-320	CNMA-320	MB320	PMB-320	CNMB-320	MC320	PMC-320	CNMC-320	MT320	CNMT-320	MM320	CNMM-320
30"	MA330	PMA-330	CNMA-330	MB330	PMB-330	CNMB-330	MC330	PMC-330	CNMC-330	MT330	CNMT-330	MM330	CNMM-330
40"	MA340	PMA-340	CNMA-340	MB340	PMB-340	CNMB-340	MC340	PMC-340	CNMC-340	MT340	CNMT-340	MM340	CNMM-340
51"	MA351	PMA-351	CNMA-351	MB351	PMB-351	CNMB-351	MC351	PMC-351	CNMC-351	MT351	CNMT-351	MM351	CNMM-351
60"	MA360	PMA-360	CNMA-360	MB360	PMB-360	CNMB-360	MC360	PMC-360	CNMC-360	MT360	CNMT-360	MM360	CNMM-360

NOTE: Type 'T' Lines – Toyota / GM Long Nut.



STEEL BRAKE LINE MERCHANDISERS PRÉSENTOIRS TUBULURE DE FREIN

Papcoflex steel brake line floor merchandisers are available in 5 variations and may be linked together to form a master warehouse stock to cover almost every brake line requirement. Compact wire rack measures 9-1/2" w x 20-1/2" d x 28" h and includes colour-coded, permanent PVC storage tubes for dispensing lines. Each Papcoflex Brake Line is labelled showing part number, O.D. and length.



No. 022-284

Empty Wire Rack (with tubes and colour-coded labels to create your own mix of lines)

STEEL BRAKE LINE MERCHANDISER

No. 022-285

Contains 3 each of 28 sizes of Papcoflex Brake Lines for a total of 84 lines. Rack and tubes included.

POLY-V COATED BRAKE LINES MERCHANDISER

No. 022-585

Contains 3 each of 28 sizes of **POLY-V** Coated Steel Brake Lines for a total of 84 lines. Rack and tubes included.

S - STEEL **P - POLY-V**

ORDER BY STOCK NUMBER

Overall Length	3/16 O.D.		1/4 O.D.		5/16 O.D.		3/8 O.D.	
	S	P	S	P	S	P	S	P
8"	S-308	PS-308	S-408	PS-408	S-508	PS-508	S-610	PS-608
12"	S-312	PS-312	S-412	PS-412	S-512	PS-512	S-612	PS-612
20"	S-320	PS-320	S-420	PS-420	S-520	PS-520	S-620	PS-620
30"	S-330	PS-330	S-430	PS-430	S-530	PS-530	S-630	PS-630
40"	S-340	PS-340	S-440	PS-440	S-540	PS-540	S-640	PS-640
51"	S-351	PS-351	S-451	PS-451	S-551	PS-551	S-651	PS-651
60"	S-360	PS-360	S-460	PS-460	S-560	PS-560	S-660	PS-660

ARMOURED BRAKE LINE MERCHANDISER

No. 022-286

Contains 3 each of 28 sizes of Papcoflex Armoured Brake Lines for a total of 84 lines. Rack and tubes included.

AS - ARMOURD STEEL

ORDER BY STOCK NUMBER

Overall Length	3/16 O.D.	1/4 O.D.	5/16 O.D.	3/8 O.D.
	AS	AS	AS	AS
8"	AS-308	AS-408	AS-508	AS-610
12"	AS-312	AS-412	AS-512	AS-612
20"	AS-320	AS-420	AS-520	AS-620
30"	AS-330	AS-430	AS-530	AS-630
40"	AS-340	AS-440	AS-540	AS-640
51"	AS-351	AS-451	AS-551	AS-651
60"	AS-360	AS-460	AS-560	AS-660

METRIC BRAKE LINE MERCHANDISER

No. 022-287

Contains 3 each of 21 sizes of Papcoflex Metric Brake Lines for a total of 63 lines. Rack and tubes included.

POLY-V COATED METRIC BRAKE LINES MERCHANDISER

022-586

Contains 3 each of 21 sizes of **POLY-V** Coated Metric Brake Lines for a total of 63 lines. Rack and tubes included.

S - STEEL **P - POLY-V**

ORDER BY STOCK NUMBER

Overall Length	TYPE 'A' JAPANESE		TYPE 'B' BRITISH		TYPE 'C' EUROPEAN	
	S	P	S	P	S	P
8"	MA308	PMA-308	MB308	PMB-308	MC308	PMC-308
12"	MA312	PMA-312	MB312	PMB-312	MC312	PMC-312
20"	MA320	PMA-320	MB320	PMB-320	MC320	PMC-320
30"	MA330	PMA-330	MB330	PMB-330	MC330	PMC-330
40"	MA340	PMA-340	MB340	PMB-340	MC340	PMC-340
51"	MA351	PMA-351	MB351	PMB-351	MC351	PMC-350
60"	MA360	PMA-360	MB360	PMB-360	MC360	PMC-360

NOTE: PMA Series **POLY-V** Brake Lines are supplied with Long Nuts for compatibility with Toyota/GM brake line requirements.



BRAKE LINE MERCHANDISERS PRÉSENTOIRS TUBULURE DE FREIN

Each merchandiser includes a rugged metal rack complete with measuring gauge. Merchandisers can be hung on a wall, shelf end, or post. When joining two or more brake lines, use Papco® Inverted Flare Unions.

STEEL BRAKE LINE MERCHANDISERS

No. 022-079

Contains 48 Lengths of the most popular 5/16" and 3/8" diameter Steel Brake Lines. Four each of 5/16" and 3/8 x 12", 20", 30", 40", 51" and 60".

No. 022-080

Contains 56 Lengths of the most popular 3/16" and 1/4" diameter Steel Brake Lines. Four each of 3/16" and 1/4 x 8", 12", 20", 30", 40", 51" and 60".

ARMOURED STEEL BRAKE LINE MERCHANDISERS

No. 022-081

Contains 56 lengths of the most popular 3/16" and 1/4" diameter Armoured Brake Lines. Four each of 3/16" and 1/4"x 8", 12", 20", 30", 40", 51" and 60".

No. 022-082

Contains 48 lengths of the most popular 5/16" and 3/8" diameter Armoured Brake Lines. Four each of 5/16" and 3/8"x 12", 20", 30", 40", 51" and 60".

POLY-V COATED BRAKE LINE MERCHANDISER

No. 022-587

Contains 56 Lengths of the most popular 3/16" and 1/4" diameter Coated Brake Lines. Four each of 3/16" and 1/4 x 8", 12", 20", 30", 40", 51" and 60".

No. 022-588

Contains 48 Lengths of **POLY-V** Coated Brake Lines. Four each of 5/16" and 3/8 x 12", the most popular 5/16" and 3/8" diameter 20", 30", 40", 51" and 60".

STEEL METRIC BRAKE LINE MERCHANDISER

No. 022-483

Contains 42 lines - three of each of the 14 listed lengths of Steel Metric Brake Lines in Type 'A' and 'C'.

No. 022-484

Contains 42 lines - three of each of the 14 listed lengths of Steel Metric Brake Lines for Toyota and GM/Imports.

POLY-V COATED METRIC BRAKE LINE MERCHANDISER

No. 022-485

Contains 42 lines - three of each of the 14 listed lengths of Poly-V coated Metric Brake Lines in Type 'A' and 'C'.

EMPTY BRAKE LINE RACKS

No. 022-077

For 3/16" and 1/4" Dia. Brake Lines.

No. 022-078

For 5/16" and 3/8" Dia. Brake Lines.

METRIC BRAKE AND FUEL LINE DOMESTIC/EUROPEAN

No. 022-077MA

METRIC BRAKE AND FUEL LINE TOYOTA/GM

No. 022-077MT

BRAKE LINE ADAPTOR LINES (STANDARD AND METRIC)

No. 022-077AL





**BRAKE LINE TUBING
TUYAU DE FREIN**



S - STEEL		P - POLY-V		CN - COPPER NICKEL	
ORDER BY STOCK NUMBER					
Outside Dia.	Steel	POLY-V	COPPER NICKEL	Standard coil length - 25 ft.	
				Wall thickness	
3/16	901-131	PC-325	CN-325	0.28	
1/4	901-141	PC-425	CN-425		
5/16	901-151	PC-525	CN-525		
3/8	901-161	PC-625	CN-625		

COPPER TUBING

Construction: Cold drawn to size, seamless and fully annealed alloy. Advantages: Soft temper permits single and double flares as well as easy hand shaping. Applications: Suitable for refrigeration, gasoline and oil lines on automobiles, trucks, marine and diesel engines, oil burners, water lines, industrial and general purpose use. Available in 25*, 50 and 100 foot coils.

ORDER BY STOCK NUMBER

Stock No.			Outside Dia.	Wall Thick.	Weight Per 100 ft.	W/P psi @100°F
25 ft.	50 ft.	100 ft.				
901-221	901-222	901-223	1/8	.030	3.5 lbs.	3130
901-231	901-232	901-233	3/16	.030	5.8 lbs.	1990
901-241	901-242	901-243	1/4	.030	8.0 lbs.	1450
901-251	901-252	901-253	5/16	.032	11.0 lbs.	1230
901-261	901-262	901-263	3/8	.032	13.4 lbs.	900
901-271	901-272	901-273	1/2	.032	18.2 lbs.	740
901-281	901-282	901-283	5/8	.035	23.2 lbs.	640
901-291	901-292	901-293	3/4	.035	28.0 lbs.	640

* Individually Packaged up to 3/8 O.D.

W/P - Working Pressure

**HYDRAULIC BRAKE FITTINGS
RACCORDS DE FREINS HYDRAULIQUES**

8" MASTER CYLINDER ADAPTOR LINES (COLOUR CODED)

INDIVIDUALLY PACKAGED

Steel	POLY-V	Tube size	Thread & Flared Type	Thread & Flared Type	Colour Code
913-001	P913-001	1/4	7/16-24 - Inverted	7/16-24 - Inverted	Gold
913-002*	P913-002 ✓	3/16	3/8-24 - Inverted	7/16-24 - Inverted	Red
913-003*	P913-003 ✓	3/16	3/8-24 - Inverted	1/2-20 - Inverted	Black
913-004*	P913-004 ✓	3/16	3/8-24 - Inverted	1/2-20 - Inverted	Green
913-005*	P913-005 ✓	1/4	7/16-24 - Inverted	9/16-18 - Inverted	Blue
913-006*	P913-006 ✓	3/16	3/8-24 - Inverted	9/16-18 - Inverted	Olive
913-007*	P913-007 ✓	1/4	7/16-24 - Inverted	1/2-20 - Inverted	Gold
913-008*	P913-008 ✓	3/16	3/8-24 - Inverted	10mm-1.0 - Bubble	Olive
913-009*	P913-009 ✓	3/16	10mm-1.0 - Bubble	11mm-1.0 - Bubble	Orange
913-010*	P913-010 ✓	3/16	10mm-1.0 - Bubble	12mm-1.0 - Bubble	Orange
913-011*	P913-011 ✓	3/16	10mm-1.0 - Bubble	13mm-1.0 - Bubble	Green
913-012*	P913-012 ✓	3/16	3/8-24 - Inverted	11mm-1.0 - Bubble	Orange
913-013*	P913-013 ✓	3/16	3/8-24 - Inverted	12mm-1.0 - Bubble	Blue
913-014*	P913-014 ✓	3/16	3/8-24 - Inverted	13mm-1.5 - Bubble	Green
913-015*	P913-015 ✓	3/16	3/8-24 - Inverted	10mm-1.0 - Inverted	Blue
913-016	P913-016	1/4	7/16-24 - Inverted	12mm-1.0 - Bubble	Olive
913-017	P913-017	6 mm	12mm-1.0 - Bubble	12mm-1.5 - Bubble	Olive
913-018	P913-018	6 mm	12mm-1.0 - Bubble	14mm-1.5 - Bubble	Black



STEEL MASTER CYLINDER ADAPTOR LINES

ASSORTMENT NO. 022-845

Contains a total of 28 Adaptor Lines 2 each of the 14 most popular sizes as indicated above (*)



POLY-V COATED STEEL MASTER CYLINDER ADAPTOR LINES

ASSORTMENT NO. 022-846

Contains a total of 28 **POLY-V** Adaptor Lines 2 each of the 14 most popular sizes as indicated above (✓)



**BRAKE LINE FITTINGS
RACCORDS POUR CONDUITES DE FREINS**

STEEL TUBE NUTS – STANDARD

Standard Package 10 Pieces

Part No.	Tube size	Thread size
DS141-3	3/16	3/8-24
DS141-4	1/4	7/16-24
DS141-5	5/16	1/2-20
DS141-6	3/8	5/8-18



STEEL TUBE NUTS – LONG

Standard Package 10 Pieces

Part No.	Tube size	Thread size
DSL141-3	3/16	3/8-24
DSL141-4	1/4	7/16-24



STEEL TUBE NUTS – OVERSIZE HEX

Standard Package 10 Pieces

Part No.	Tube size	Thread size
DS141-4-3	1/4 x 3/16	7/16-24
DS141-5-3	5/16 x 3/16	1/2-20
DS141-5-4	5/16 x 1/4	1/2-20
DS141-6-3	3/8 x 3/16	5/8-18
DS141-6-4	3/8 x 1/4	5/8-18



UNIONS

Standard Package 10 Pieces

Part No.	Tube size	Thread size
D142-3	3/16	3/8-24
D142-4	1/4	7/16-24
D142-5	5/16	1/2-20
D142-6	3/8	5/8-18



BRAKE BLEEDER SCREWS

Standard Package 5 Pieces

Part No.	Size	Application	Type
904-200	3/8-24 x 1.51"	Ford	1
904-201	M10-1.0 x 27.5mm	GM / Ford	3
904-203	3/8-24 x 1.19"	GM / Ford / Chrysler / Jeep	1
904-204	M8-1.25 x 33mm	GM / Honda	3
904-205	M8-1.25 x 25.2mm	GM / Honda / Acura	2
904-206	1/4-28 x .920"	Ford / Volvo	1
904-207	M10-1.5 x 29.3mm	GM	2
904-209	M7-1.0 x 34mm	Domestic / Import	1
904-210	M10-1.0 x 35.2mm	Domestic / Import	2
904-211	M10-1.0 x 36.7mm	Toyota / Lexus	2
904-212	M10-1.0 x 32.75mm	Domestic / Import	1
904-213	5/16-24 x 1.01"	GM	1
904-214	M7-1.0 x 37.6mm	Most Import	1
904-215	7/16-20 x 1.26	Ford	2
904-216	M8-1.0 x 37.3mm	Ford/Mazda/Geo/Isuzu	1
904-218	Small Repair Insert	Universal - stripped threads	2
904-219	Large Repair Insert	Universal - stripped threads	2
904-221	M10-1.25 x 33.1mm	Domestic / Import	2
904-230	M8-1.0 x 26.4mm	Domestic / Import	2



**BRAKE BLEEDER SCREWS
MASTER ASSORTMENT**

No. 020-604

Contains 64 pieces –
See page 7 for more details.



ADAPTORS – STANDARD TO DUAL MASTER CYLINDER

Standard Package 2 Pieces

Part No.	Female Inverted Flare Seat - Thread	Male Inverted Flare Seat - Thread	Part No.	Female Inverted Flare Seat - Thread	Male Inverted Flare Seat - Thread
D1074*	5/16 - 1/2-20	5/16 - 1/2-20	D7910	3/16 - 3/8-24	3/16 - 9/16-20
D7732*	1/4 - 7/16-24	1/4 - 7/16-20	D7911	3/16 - 3/8-24	3/16 - 9/16-18
D7817*	3/16 - 3/8-24	5/16 - 1/2-20	D7912	3/16 - 9/16-18	3/16 - 1/2-20
D7818	3/16 - 3/8-24	1/4 - 7/16-24	D7913	3/16 - 1/2-20	3/16 - 9/16-18
D7828	1/4 - 7/16-24	3/16 - 3/8-24	D7915	3/8 - 5/8-18	5/16 - 1/2-20
D7829	1/4 - 7/16-24	5/16 - 1/2-20	D7916	5/16 - 1/2-20	3/8 - 5/8-18
D7908	1/4 - 7/16-24	3/16 - 9/16-18	D7917*	5/16 - 1/2-20	1/4 - 7/16-24
D7909	3/16 - 3/8-24	5/16 - 1/2-20			



* Seals on hex face



BRAKE LINE FITTINGS RACCORDS POUR CONDUITES DE FREINS

METRIC BRAKE LINE FLARE NUTS

Standard Package 10 Pieces

Steel	Tube size	Flare Type	Thread-Application	Colour Code
MA300	3/16	Inverted Flare	10mm-1.0 - Toyota	Blue
MA317	3/16	Inverted Flare	10mm-1.0 - Toyota/GM	Blue
MA327	3/16	Inverted Flare	10mm-1.0 - Toyota	Blue
MA343	3/16	Inverted Flare	10mm-1.0 - Japanese	Blue
MB311	3/16	Bubble Flare	3/8-24 - British	Violet
MC300	3/16	Bubble Flare	10mm-1.0 - Euro/Domestic	Olive
MC313	1/4	Inverted Flare	12mm-1.0 - Ford	Olive
MC314	3/16	Bubble Flare	10mm-1.0 - VW/Audi	Violet
MC341	3/16	Bubble Flare	12mm-1.0 - GM/Ford	Blue
MC342	3/16	Bubble Flare	13mm-1.5 - GM/Ford	Green
MC343	3/16	Bubble Flare	11mm-1.5 - GM/Ford	Orange/Grey
MC612	6 mm	Bubble Flare	12mm-1.0	Olive
MC613	6 mm	Bubble Flare	12mm-1.5	Olive
MC614	6 mm	Bubble Flare	14mm-1	Black



METRIC / INCH INVERTED FLARE AND BUBBLE FLARE UNIONS

Standard Package 2 Pieces

Part No.	Tube Size	Thread Size	Seat Type
PC1190	3/16	3/8-24	Bubble Fare
PC1191	3/16	M10-1.0	Bubble Fare
PC1192	3/16	M10-1.0	Inverted Flare
PC1193	M6	M12-1.0	Inverted Flare



ADAPTORS – METRIC TO METRIC BUBBLE FLARE

Standard Package 2 Pieces

Part No.	Tube Size	Female Bubble Flare Seat	Male Bubble Flare Tube
PC1179	3/16	M10-1.0	M11-1.5
PC1180	3/16	M10-1.0	M12-1.0
PC1181	3/16	M10-1.0	M13-1.5



ADAPTORS – INVERTED FLARE TO INCH / METRIC BUBBLE FLARE

Standard Package 2 Pieces

Part No.	Tube Size	Female Inverted Flare Seat	Male Bubble Flare Tube
PC1177	3/16	3/8-24	3/8-24
PC1178	3/16	3/8-24	M10-1.0



ADAPTORS – INVERTED FLARE TO METRIC BUBBLE FLARE

Standard Package 2 Pieces

Part No.	Tube Size	Female Inverted Flare Sea	Male Inverted Flare Tube
PC1176	3/16	3/8-24	M10-1.0



HYDRAULIC GREASE FITTINGS GRAISSEURS HYDRAULIQUE

Papco® Hydraulic Grease Fittings are manufactured from high-quality, case hardened steel and are zinc plated to resist corrosion. Each fitting is heat treated and tested to 8,000 p.s.i. Spring-loaded ball check valve ensures a dirt-free lubrication system. Papco® Grease Fittings are available in all popular thread types including thread-forming and metric.

ORDER BY STOCK NUMBER

Standard Package: 25 Pieces

<i>Type 1 Straight</i>	<i>Type 2 30° Elbow</i>	<i>Type 3 45° Elbow</i>	<i>Type 4 65° Elbow</i>	<i>Type 5 90° Elbow</i>	<i>Type 6 Thread-Forming</i>	<i>Type 7 Straight Long</i>
Stock No.	Type	Description	Stock No.	Type	Description	
904-607	7	1/8 NPT Straight Long	904-691	5	1/4-28 90° Elbow	
904-610	1	1/8 NPT Straight	904-692	1	5/16-24 Straight	
904-611	2	1/8 NPT 30° Elbow	904-693	1	3/8-24 Straight	
904-688	3	1/8 NPT 45° Elbow	904-690	6	1/4-28 Thread-Forming	
904-612	4	1/8 NPT 65° Elbow	Metric Fittings			
904-613	5	1/8 NPT 90° Elbow	904-701	1	6 mm x 1.0 Straight	
904-627	1	1/4 NPT Straight	904-745	3	6 mm x 1.0 45° Elbow	
904-629	4	1/4 NPT 65° Elbow	904-790	5	6 mm x 1.0 90° Elbow	
904-641	1	1/4-28 Straight	904-702	1	8 mm x 1.0 Straight	
904-652	7	1/4-28 Straight Long	904-746	3	8 mm x 1.0 45° Elbow	
904-636	3	1/4-28 45° Short	904-791	5	8 mm x 1.0 90° Elbow	
904-637	3	1/4-28 45° Long	904-703	1	10 mm x 1.0 Straight	

GREASE FITTINGS MASTER ASSORTMENT

No. 020-685

Contains 160 pieces of 17 popular sizes.
Packed in a rigid all metal box.

GREASE FITTINGS ASSORTMENT

No. 020-901 (Inch)

No. 020-902 (Metric)

Each assortment contains 100 Grease Fittings
in 6 popular sizes.

ORDER BY STOCK NUMBER

Stock No.	Pieces	Stock No.	Pieces
No. 020-901	Inch	No. 020-902	Metric
904-641	60	904-701	40
904-610	20	904-702	20
904-637	6	904-703	10
904-691	6	904-745	10
904-688	4	904-746	10
904-613	4	904-790	10



AN INTRODUCTION TO...

BUILDERS' & AGRICULTURAL FASTENERS

ATTACHES POUR L'AGRICULTURE

...UNE INTRODUCTION.

www.hpaulin.com

For a full listing of Builders', & Agricultural Fasteners please refer to our current catalogue or visit our website to download a PDF version.



**BUILDERS' & AGRICULTURAL
HARDWARE MERCHANDISER**

HOOKS & EYE BOLTS

LAG THREAD SCREW EYES

LIFTING EYES

J-BOLTS

U-BOLTS

TURNBUCKLES & S-HOOKS

**WIRE ROPE CLIPS
& THIMBLES**

WELDED RINGS & DEES

BOLT SNAPS & SWIVELS

SPRING & ANIMAL SNAPS

SNAPS & PULLEYS

CHAIN HOOKS & LATCHES

CONNECTION HARDWARE

LINKS & CHAIN SWIVELS

**ROPE LOOPS, CLEATS
& CLAMPS**

ROPE ACCESSORIES

LOCK PINS

HITCH PINS

**SHAFT COLLARS &
MACHINERY BUSHINGS**

**METRIC SHAFT COLLARS
& HITCH PIN CLIPS**

DISPLAY BOARDS



BUILDERS' & AGRICULTURAL HARDWARE MERCHANDISER
PRÉSENTOIR DE QUINCAILLERIE DE BÂTIMENTS ET POUR L'AGRICULTURE



Empty Merchandiser Rack No. 022-001
 38"W x 38"D x 75"H

papeco[®] **DISPLAY BOARDS**

Choose from 46 product display boards to customize your own 36 panel merchandiser. Empty rack No. 022-001 is supplied at no charge with any order of 36 panels. Each panel is 12 inches wide and 21 inches long and includes an actual size graphic of each product for ease of placement and display hooks.

EMPTY MERCHANDISER RACK NO. 022-001

Durable, free-standing unit includes 4 casters for effort-free positioning. Holds 36 display panels and measures 38 inches wide by 38 inches deep by 75 inches tall.

FEATURES

- Highly visible and accessible products
- Space saving rack
- Neatly organized presentation of product
- Helps increase sales
- All items individually bar-coded

For our complete line of Builders' and Agricultural Fasteners see our most current catalogue.

PANEL ASSORTMENT INDEX

Part No.	Panel No.	Description	Panel Size
996450	2	Screw Hooks Large	12" x 21"
996452	4	Lag Thread Screw Eyes Large	12" x 21"
996453	5	Lag Thread Screw Eyes & Ceiling Hooks – Brass Finish	12" x 21"
996458	10	Eye Bolts Extra Large A	12" x 21"
996459	11	Eye Bolts Extra Large B	12" x 21"
996460	12	Eye Bolts Extra Large C	12" x 21"
996461	13	Eye Bolts Extra Large D	12" x 21"
996462	14	Forged Steel Eye Bolts Plain – Galvanized	12" x 21"
996463	15	Forged Steel Eye Bolts With Shoulder – Galvanized	12" x 21"
996464	16	Forged Steel Lifting Eyes – Self Colored	12" x 21"
996465	17	Clothesline Hooks & J-Bolts	12" x 21"
996467	19	U-Bolts Large A	12" x 21"
996468	20	U-Bolts Large B	12" x 21"
996469	21	Square U-Bolts	12" x 21"
996470	22	Square U-Bolts – Lumber Sized	12" x 21"
996471	23	Turnbuckles – Hook & Hook	12" x 21"
996472	24	Turnbuckles – Eye & Eye	12" x 21"
996473	25	Turnbuckles – Hook & Eye	12" x 21"
996474	26	Turnbuckles – E&E and H&E Combination	12" x 21"
996475	27	Forged/Galvanized Turnbuckles – Hook & Eye	12" x 21"
996476	28	Forged/Galvanized Turnbuckles – Eye & Eye	12" x 21"
996478	30	Wire Rope Clips & Thimbles Large	12" x 21"
996479	31	Welded Rings and Dees	12" x 21"
996480	32	Bolt Snaps & Swivels	12" x 21"
996481	33	Spring and Animal Snaps	12" x 21"
996482	34	Brass Snaps	12" x 21"
996483	35	Awning Pulleys	12" x 21"
996484	36	Heavy Duty Pulleys	12" x 21"
996485	37	Forged/Zinc Eye Type Chain Hooks	12" x 21"
996486	38	Forged/Zinc Clevis Type Chain Hooks	12" x 21"
996487	39	Chain Hooks with Latches	12" x 21"
996488	40	Forged G70 Chain Hooks	12" x 21"
996489	41	Forged/Galvanized Connection Hardware	12" x 21"
996490	42	Links and Chain Swivels	12" x 21"
996491	43	Rope Loops, Cleats, Clamps & Hooks	12" x 21"
996492	44	Rope Accessories	12" x 21"
996493	45	Stainless Steel Eye Bolts, Lag Eyes & Hooks	12" x 21"
996494	46	Stainless Steel U-Bolts	12" x 21"
996495	47	Stainless Steel Turnbuckles, Screw Eyes & S Hooks	12" x 21"
996496	48	Stainless Steel Links, Snaps & Hooks	12" x 21"
996497	49	Bolts Snaps, Spring Snaps & Animal Snaps Combination	12" x 21"
996502	55	Hitch Pins – Zinc & Yellow	12" x 21"
996503	56	Hitch Pins – Zinc & Yellow Part 2	12" x 21"
996504	57	Hitch Pins – Rubber Handle	12" x 21"
996505	58	Hitch Pins – Rubber Handle Part 2	12" x 21"
996506	59	Lock Pins – Square, Round & Spring	12" x 21"
996507	60	Shaft Collars & Machinery Bushings	12" x 21"
996508	61	Metric Shaft Collars & Hitch Pins Clips	12" x 21"
996499	50	Blank Black 12" x 21"	12" x 21"
996501	51	Blank Grey 12" x 21"	12" x 21"

Screw Hooks LARGE

Panel 2 — 996450

Total SKUs: 17

Part #	Description
321220	Screw Hook Zinc .307 x 4-15/16
321222	Screw Hook Zinc .263 x 4-7/16
321224	Screw Hook Zinc .244 x 4-1/8
321226	Screw Hook Zinc .225 x 3-7/8
321228	Screw Hook Zinc .192 x 3-3/8
321238	Screw Hook Brass .244 x 4-7/16
321240	Screw Hook Brass .207 x 4-1/8
321242	Screw Hook Brass .192 x 3-5/8
321244	Screw Hook Brass .162 x 3-3/8
321246	Screw Hook Brass .162 x 2-9/16
321248	Screw Hook Brass .135 x 2-1/16
321254	Heavy Duty Screw Hook 3/8 x 10
321253	Heavy Duty Screw Hook 3/8 x 8
321808	Heavy Duty Screw Hook 3/8 x 4-7/8
851881	Heavy Duty Screw Hook 3/8 x 4-1/2
321806	Heavy Duty Screw Hook 5/16 x 4-1/2
321804	Heavy Duty Screw Hook 1/4 x 4-1/4
996450	Panel 2 — Screw Hooks Large



Lag Thread Screw Eyes LARGE

Panel 4 — 996452

Total SKUs: 16

Part #	Description
320968	Large Scr Eye Zinc .263 x 2-7/8
320966	Large Scr Eye Zinc .307 x 2-7/8
320964	Large Scr Eye Zinc .363 x 3-7/8
321140	Lag Thread Scr Eye Zinc 1/4 x 3
321142	Lag Thread Scr Eye Zinc 1/4 x 3-3/4
321145	Lag Thread Scr Eye Zinc 1/4 x 5
321148	Lag Thread Scr Eye Zinc 5/16 x 4
321150	Lag Thread Scr Eye Zinc 5/16 x 5
321154	Lag Thread Scr Eye Zinc 5/16 x 6
321155	Lag Thread Scr Eye Zinc 3/8 x 4-1/2
321156	Lag Thread Scr Eye Zinc 3/8 x 5-1/2
321158	Lag Thread Scr Eye Zinc 3/8 x 6
321160	Lag Thread Scr Eye Zinc 3/8 x 8
321162	Lag Thread Scr Eye Zinc 7/16 x 5-1/4
321164	Lag Thread Scr Eye Zinc 1/2 x 5-1/2
321166	Lag Thread Scr Eye Zinc 1/2 x 8
996452	Panel 4 — Lag Thread Scr Eye Large

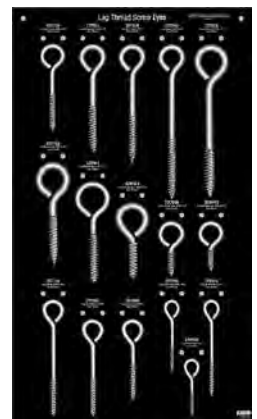

Brass Lag Thread Screw Eyes & Ceiling Hooks

Panel 5 — 996453

Total SKUs: 19

Part #	Description
320954	Brass Large Scr Eye .192 x 1-15/16
320952	Brass Large Scr Eye .225 x 2-3/16
320950	Brass Large Scr Eye .307 x 2-7/8
321180	Lag Thread Scr Eye Brass Ptd 1/4 x 3-3/4
321182	Lag Thread Scr Eye Brass Ptd 1/4 x 5
321184	Lag Thread Scr Eye Brass Ptd 5/16 x 4
321186	Lag Thread Scr Eye Brass Ptd 5/16 x 6
321188	Lag Thread Scr Eye Brass Ptd 3/8 x 4-1/2
321190	Lag Thread Scr Eye Brass Ptd 3/8 x 8
321248	Screw Hook Brass .135 x 2-1/16
321246	Screw Hook Brass .162 x 2-9/16
321244	Screw Hook Brass .162 x 3-3/8
321242	Screw Hook Brass .192 x 3-5/8
321238	Screw Hook Brass .244 x 4-7/16
322122	S Hook Zinc .272 x 2-3/4
322124	S Hook Zinc .307 x 3
322138	S Hook Brass Plated .250 x 2-1/4
322140	S Hook Brass Plated .272 x 2-3/4
322142	S Hook Brass Plated .307 x 3
996453	Panel 5 — Brass Lag Eyes & Hooks



Stainless Steel Eye Bolts & Hooks

Panel 45 — 996493

Total SKUs: 20

Part #	Description
851882	SS Eye Bolt w/ Nut 3/16 x 1-1/2
320754	SS Eye Bolt w/ Nut 3/16 x 2
320756	SS Eye Bolt w/ Nut 1/4-20 x 2
320758	SS Eye Bolt w/ Nut 1/4-20 x 2-5/8
320760	SS Eye Bolt w/ Nut 1/4-20 x 3
320762	SS Eye Bolt w/ Nut 1/4-20 x 4
320764	SS Eye Bolt w/ Nut 5/16-18 x 3-1/4
320766	SS Eye Bolt w/ Nut 5/16-18 x 4
851883	SS Eye Bolt w/ Nut 5/16-18 x 5
320768	SS Eye Bolt w/ Nut 3/8-16 x 3-7/8
851884	SS Eye Bolt w/ Nut 3/8-16 x 5
320770	SS Eye Bolt w/ Nut 3/8-16 x 6
320772	SS Eye Bolt w/ Nut 3/8-16 x 8
321168	SS Lag Thread Scr Eye 1/4 x 3-3/4
321170	SS Lag Thread Scr Eye 1/4 x 5
321172	SS Lag Thread Scr Eye 5/16 x 4
321174	SS Lag Thread Scr Eye 3/8 x 4-1/2
851879	SS Heavy Duty Scr Hook 1/4 x 4-1/4
851880	SS Heavy Duty Scr Hook 3/8 x 4-7/8
852441	SS Clothes Hook 5/16 x 5
996493	Panel 45 — SS Eye Bolts & Hooks



Eye Bolts with Hex Nuts EXTRA LARGE A

Panel 10 — 996458

Total SKUs: 13

Panels 10, 11, 12 and 13 should be merchandised together.

Part #	Description
320700	Eye Bolt w/ Nut Zinc 10-24 x 1-1/2
320702	Eye Bolt w/ Nut Zinc 10-24 x 2
320704	Eye Bolt w/ Nut Zinc 10-24 x 2-1/2
320706	Eye Bolt w/ Nut Zinc 1/4-20 x 2
320708	Eye Bolt w/ Nut Zinc 1/4-20 x 2-1/2
320710	Eye Bolt w/ Nut Zinc 1/4-20 x 3
320718	Eye Bolt w/ Nut Zinc 1/4-20 x 8
320728	Eye Bolt w/ Nut Zinc 5/16-18 x 5
320730	Eye Bolt w/ Nut Zinc 5/16-18 x 6
320732	Eye Bolt w/ Nut Zinc 5/16-18 x 8
320738	Eye Bolt w/ Nut Zinc 3/8-16 x 5
320740	Eye Bolt w/ Nut Zinc 3/8-16 x 6
320742	Eye Bolt w/ Nut Zinc 3/8-16 x 8
996458	Panel 10 — Eye Bolts Extra Large A

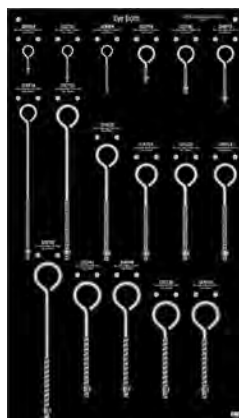

Eye Bolts with Hex Nuts EXTRA LARGE B

Panel 11 — 996459

Total SKUs: 7

Panels 10, 11, 12 and 13 should be merchandised together.

Part #	Description
320712	Eye Bolt w/ Nut Zinc 1/4-20 x 4
320714	Eye Bolt w/ Nut Zinc 1/4-20 x 5
320716	Eye Bolt w/ Nut Zinc 1/4-20 x 6
320722	Eye Bolt w/ Nut Zinc 5/16-18 x 3-1/4
320724	Eye Bolt w/ Nut Zinc 5/16-18 x 4
320734	Eye Bolt w/ Nut Zinc 3/8-16 x 2-1/2
320736	Eye Bolt w/ Nut Zinc 3/8-16 x 4
996459	Panel 11 — Eye Bolts Extra Large B



**Eye Bolts with Hex Nuts
EXTRA LARGE C**

Panel 12 – 996460

Total SKUs: 7

Panels 10, 11, 12 and 13 should be merchandised together.

Part #	Description
320748	Eye Bolt w/ Nut Zinc 1/2-13 x 8
320750	Eye Bolt w/ Nut Zinc 1/2-13 x 10
320752	Eye Bolt w/ Nut Zinc 1/2-13 x 12
320774	Eye Bolt w/ Nut Zinc 5/8-11 x 6
321796	Clothes Hook Bolt Zinc 5/16-18 x 6
321798	Clothes Hook Bolt Zinc 3/8-16 x 7-1/4
321800	Clothes Hook Bolt Zinc 3/8-16 x 8-1/4
996460	Panel 12 – Eye Bolts Extra Large C

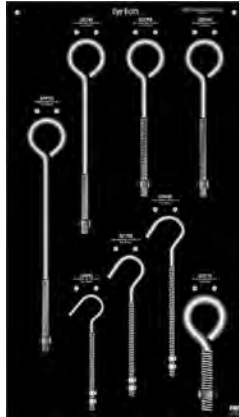

**Eye Bolts with Hex Nuts
EXTRA LARGE D**

Panel 13 – 996461

Total SKUs: 6

Panels 10, 11, 12 and 13 should be merchandised together.

Part #	Description
320744	Eye Bolt w/ Nut Zinc 1/2-13 x 4
320746	Eye Bolt w/ Nut Zinc 1/2-13 x 6
320775	Eye Bolt w/ Nut Zinc 5/8-11 x 8
320776	Eye Bolt w/ Nut Zinc 5/8-11 x 10
320777	Eye Bolt w/ Nut Zinc 5/8-11 x 12
320778	Eye Bolt w/ Nut Zinc 5/8-11 x 14
996461	Panel 13 – Eye Bolts Extra Large D



**Forged Steel Eye Bolts Plain
– Galvanized**

Panel 14 – 996462

Total SKUs: 9

Part #	Description
320800	Frgd/Galv Eye Bolt w/ Nut 1/4-20 x 3-1/8
320802	Frgd/Galv Eye Bolt w/ Nut 1/4-20 x 5
320804	Frgd/Galv Eye Bolt w/ Nut 5/16-18 x 3-5/8
320806	Frgd/Galv Eye Bolt w/ Nut 5/16-18 x 5-1/2
320808	Frgd/Galv Eye Bolt w/ Nut 3/8-16 x 4
320810	Frgd/Galv Eye Bolt w/ Nut 3/8-16 x 6
320812	Frgd/Galv Eye Bolt w/ Nut 1/2-13 x 8
320814	Frgd/Galv Eye Bolt w/ Nut 1/2-13 x 10
320816	Frgd/Galv Eye Bolt w/ Nut 1/2-13 x 12
996462	Panel 14 – Forged Eye Bolts Plain

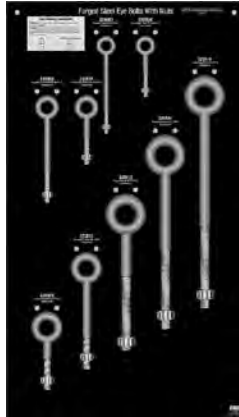

**Forged Steel Eye Bolts
w/Shoulder – Galvanized**

Panel 15 – 996463

Total SKUs: 11

Part #	Description
851885	Frgd/Galv Eye Bolt w/ Shoulder 1/4 x 2
851886	Frgd/Galv Eye Bolt w/ Shoulder 1/4 x 4
851887	Frgd/Galv Eye Bolt w/ Shoulder 5/16 x 2-1/4
851888	Frgd/Galv Eye Bolt w/ Shoulder 5/16 x 4-1/4
851889	Frgd/Galv Eye Bolt w/ Shoulder 3/8 x 2-1/2
851890	Frgd/Galv Eye Bolt w/ Shoulder 3/8 x 4-1/2
851891	Frgd/Galv Eye Bolt w/ Shoulder 3/8 x 6
851892	Frgd/Galv Eye Bolt w/ Shoulder 1/2 x 3-1/4
851893	Frgd/Galv Eye Bolt w/ Shoulder 1/2 x 6
851894	Frgd/Galv Eye Bolt w/ Shoulder 1/2 x 8
851895	Frgd/Galv Eye Bolt w/ Shoulder 1/2 x 10
996463	Panel 15 – Forged Eye Bolts w/ Shoulder



Forged Steel Lifting Eyes

Panel 16 – 996464

Total SKUs: 12

Part #	Description
320600	Forged Lifting Eye Bolt Shldr 1/4-20
320601	Forged Lifting Eye Bolt Plain 1/4-20
320602	Forged Lifting Eye Bolt Shldr 5/16-18
320603	Forged Lifting Eye Bolt Plain 5/16-18
320604	Forged Lifting Eye Bolt Shldr 3/8-16
320605	Forged Lifting Eye Bolt Plain 3/8-16
320608	Forged Lifting Eye Bolt Shldr 1/2-13
320609	Forged Lifting Eye Bolt Plain 1/2-13
320610	Forged Lifting Eye Bolt Shldr 5/8-11
320611	Forged Lifting Eye Bolt Plain 5/8-11
320612	Forged Lifting Eye Bolt Shldr 3/4-10
320613	Forged Lifting Eye Bolt Plain 3/4-10
996464	Panel 16 – Forged Lifting Eyes

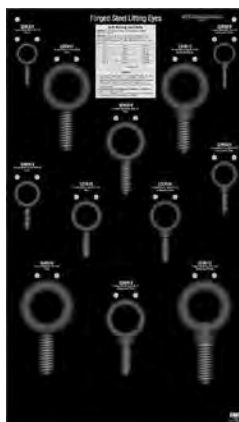

Clothesline Hook & J-Bolts

Panel 17 – 996465

Total SKUs: 15

Part #	Description
321780	J-Bolt w/ Nut Zinc 3/16(10-24) x 1-7/8
321782	J-Bolt w/ Nut Zinc 7/32(12-24) x 2-1/8
321784	J-Bolt w/ Nut Zinc 1/4-20 x 2-5/16
851896	J-Bolt w/ Nut Zinc 1/4-20 x 4
851897	J-Bolt w/ Nut Zinc 1/4-20 x 6
321786	J-Bolt w/ Nut Zinc 5/16-18 x 3
851898	J-Bolt w/ Nut Zinc 5/16 x 5
851899	J-Bolt w/ Nut Zinc 5/16 x 7
321788	J-Bolt w/ Nut Zinc 3/8-16 x 3-3/4
321790	J-Bolt w/ Nut Zinc 3/8-16 x 5
321792	J-Bolt w/ Nut Zinc 3/8-16 x 7
321794	J-Bolt w/ Nut Zinc 1/2-13 x 6
321796	Clothes Hook Bolt Zinc 5/16-18 x 6
321798	Clothes Hook Bolt Zinc 3/8-16 x 7-1/4
321800	Clothes Hook Bolt Zinc 3/8-16 x 8-1/4
996465	Panel 17 – Clothesline Hook & J Bolts



U-Bolts
LARGE A

Panel 19 – 996467

Total SKUs: 12

Panels 19 and 20 can be merchandised together. Panel 19 can stand alone as well.

Part #	Description
320840	U-Bolt Zinc 1/4-20 x 2-3/4 x 3/4
320842	U-Bolt Zinc 1/4-20 x 2-1/4 x 1-1/8
320844	U-Bolt Zinc 1/4-20 x 3-1/2 x 1-1/8
320846	U-Bolt Zinc 1/4-20 x 2 3/4 x 1-3/8
320848	U-Bolt Zinc 5/16-18 x 2-1/2 x 1-3/8
320850	U-Bolt Zinc 5/16-18 x 3-3/4 x 1-3/8
320852	U-Bolt Zinc 5/16-18 x 3 x 1-3/4
320854	U-Bolt Zinc 5/16-18 x 4-1/4 x 1-3/4
320856	U-Bolt Zinc 5/16-18 x 3 x 2
320858	U-Bolt Zinc 5/16-18 x 4-13/16 x 2
320862	U-Bolt Zinc 5/16-18 x 5 x 2-1/2
320870	U-Bolt Zinc 3/8-16 x 4-3/4 x 3-1/2
996467	Panel 19 – U-Bolts Large A

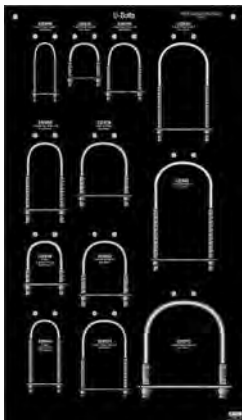

U-Bolts
LARGE B

Panel 20 – 996468

Total SKUs: 10

Panels 19 and 20 can be merchandised together.

Part #	Description
320828	U-Bolt Zinc 1/4-20 x 1-3/8 x 9/16
320830	U-Bolt Zinc 1/4-20 x 1-1/2 x 3/4
320832	U-Bolt Zinc 1/4-20 x 1-3/4 x 1
320834	U-Bolt Zinc 1/4-20 x 2-3/4 x 1-3/4
320836	U-Bolt Zinc 1/4-20 x 3-1/2 x 2
320838	U-Bolt Zinc 1/4-20 x 4 x 3/4
320860	U-Bolt Zinc 5/16-18 x 3-1/2 x 2-1/2
320864	U-Bolt Zinc 3/8-16 x 3-1/8 x 2
320866	U-Bolt Zinc 3/8-16 x 3-5/8 x 2-1/2
320868	U-Bolt Zinc 3/8-16x4-1/8 x 3
996468	Panel 20 – U-Bolts Large B

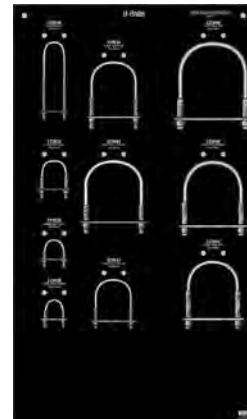

Square U-Bolts

Panel 21 – 996469

Total SKUs: 9

Part #	Description
320892	Square U-Bolt Zinc 5/16-18 x 3 x 2
320894	Square U-Bolt Zinc 5/16-18 x 5 x 2
320896	Square U-Bolt Zinc 3/8-16 x 7 x 3
320898	Square U-Bolt Zinc 3/8-16 x 3 x 4
320900	Square U-Bolt Zinc 3/8-16 x 5 x 4
320902	Square U-Bolt Zinc 3/8-16 x 6 x 4
320904	Square U-Bolt Plate Zinc for 2 Width
320906	Square U-Bolt Plate Zinc for 3 Width
320908	Square U-Bolt Plate Zinc for 4 Width
996469	Panel 21 – Square U-Bolts



Stainless Steel U-Bolts & Plates

Panel 46 – 996494

Total SKUs: 11

Part #	Description
320872	SS U-Bolt 1/4-20 x 1-3/4 x 1
320874	SS U-Bolt 1/4-20 x 2 x 1-1/8
320876	SS U-Bolt 1/4-20 x 3-1/2 x 2
320878	SS U-Bolt 5/16-18 x 2-1/2 x 1-3/8
320880	SS U-Bolt 5/16-18 x 3 x 1-3/4
320882	SS U-Bolt 5/16-18 x 3-1/2 x 2-1/2
852444	SS U-Bolt 5/16-18 x 4-1/2 x 2
320884	SS U-Bolt Plate for 1 & 1-1/8
320886	SS U-Bolt Plate for 1-1/2
320888	SS U-Bolt Plate for 1-3/4 & 2
320890	SS U-Bolt Plate for 2-1/2
996494	Panel 46 – SS U-Bolts & Plates

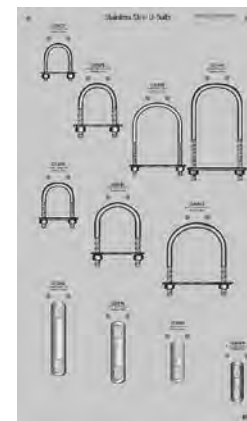

Lumber Sized Square U-Bolts

Panel 22 – 996470

Total SKUs: 4

Part #	Description
320909	Lumber Sized Sq U-Bolt 3/8-16x4x3.63
320910	Lumber Sized Sq U-Bolt 3/8-16x5x3.63
320911	Lumber Sized Sq U-Bolt 3/8-16x6x3.63
320912	Lumber Sized Sq U-Bolt 3/8-16x7x3.63
996470	Panel 22 – Lumber Sized U-Bolts



Hook & Hook Turnbuckles

Panel 23 – 996471

Total SKUs: 8

Part #	Description
321914	H&H Turnbuckle Zinc 5/32(8-32) x 1-1/4
321916	H&H Turnbuckle Zinc 3/16(10-24) x 1-5/8
321918	H&H Turnbuckle Zinc 7/32(12-24) x 1-7/8
321920	H&H Turnbuckle Zinc 1/4-20 x 2-1/8
321922	H&H Turnbuckle Zinc 5/16-18 x 2-5/8
321924	H&H Turnbuckle Zinc 3/8-16 x 3-1/8
321926	H&H Turnbuckle Zinc 3/8-16 x 6
321928	H&H Turnbuckle Zinc 1/2-13 x 6
996471	Panel 23 – Hook & Hook Turnbuckles



Eye & Eye Turnbuckles

Panel 24 – 996472

Total SKUs: 8

Part #	Description
321840	E&E Turnbuckle Zinc 5/32(8-32) x 1-1/4
321842	E&E Turnbuckle Zinc 3/16(10-24) x 1-5/8
321844	E&E Turnbuckle Zinc 7/32(12-24) x 1-7/8
321846	E&E Turnbuckle Zinc 1/4-20 x 2-1/8
321848	E&E Turnbuckle Zinc 5/16-18 x 2-5/8
321850	E&E Turnbuckle Zinc 3/8-16 x 3-1/8
321852	E&E Turnbuckle Zinc 3/8-16 x 6
321854	E&E Turnbuckle Zinc 1/2-13 x 6
996472	Panel 24 – Eye & Eye Turnbuckles

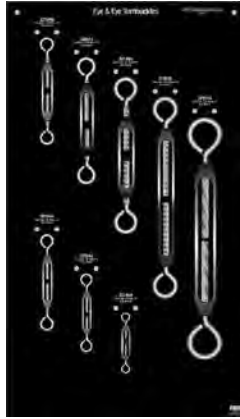

Hook & Eye Turnbuckles

Panel 25 – 996473

Total SKUs: 8

Part #	Description
321876	H&E Turnbuckle Zinc 5/32(8-32) x 1-1/4
321878	H&E Turnbuckle Zinc 3/16(10-24) x 1-5/8
321880	H&E Turnbuckle Zinc 7/32(12-24) x 1-7/8
321882	H&E Turnbuckle Zinc 1/4-20 x 2-1/8
321884	H&E Turnbuckle Zinc 5/16-18 x 2-5/8
321886	H&E Turnbuckle Zinc 3/8-16 x 3-1/8
321888	H&E Turnbuckle Zinc 3/8-16 x 6
321890	H&E Turnbuckle Zinc 1/2-13 x 6
996473	Panel 25 – Hook & Eye Turnbuckles



Turnbuckles Combination

Panel 26 – 996474

Total SKUs: 10

Part #	Description
321842	E&E Turnbuckle Zinc 3/16(10-24) x 1-5/8
321844	E&E Turnbuckle Zinc 7/32(12-24) x 1-7/8
321846	E&E Turnbuckle Zinc 1/4-20 x 2-1/8
321848	E&E Turnbuckle Zinc 5/16-18 x 2-5/8
321850	E&E Turnbuckle Zinc 3/8-16 x 3-1/8
321878	H&E Turnbuckle Zinc 3/16(10-24) x 1-5/8
321880	H&E Turnbuckle Zinc 7/32(12-24) x 1-7/8
321882	H&E Turnbuckle Zinc 1/4-20 x 2-1/8
321884	H&E Turnbuckle Zinc 5/16-18 x 2-5/8
321886	H&E Turnbuckle Zinc 3/8-16 x 3-1/8
996474	Panel 26 – E&E and H&E Turnbuckles



Forged Steel Hook & Eye Turnbuckles – Galvanized

Panel 27 – 996475

Total SKUs: 4

Part #	Description
321898	Frgd/Galv H&E Turnbuckle 3/8-16 x 6
321900	Frgd/Galv H&E Turnbuckle 1/2-13 x 6
321902	Frgd/Galv H&E Turnbuckle 1/2-13 x 9
321904	Frgd/Galv H&E Turnbuckle 5/8-11 x 6
996475	Panel 27 – Forged H&E Turnbuckles

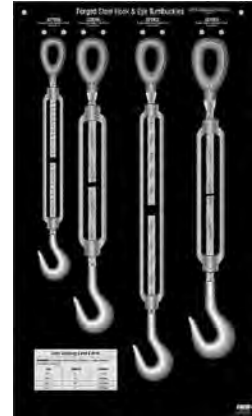

Forged Steel Eye & Eye Turnbuckles – Galvanized

Panel 28 – 996476

Total SKUs: 4

Part #	Description
321860	Frgd/Galv E&E Turnbuckle 3/8-16 x 6
321862	Frgd/Galv E&E Turnbuckle 1/2-13 x 6
321864	Frgd/Galv E&E Turnbuckle 1/2-13 x 9
321866	Frgd/Galv E&E Turnbuckle 5/8-11x6
996476	Panel 28 – Forged E&E Turnbuckles

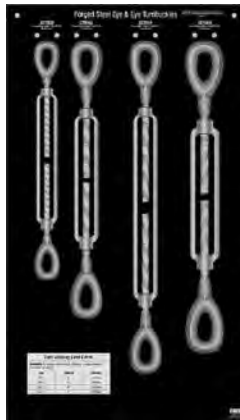

Stainless Steel Turnbuckles, Screw Eyes & S-Hooks

Panel 47 – 996495

Total SKUs: 13

Part #	Description
320982	SS Large Screw Eye 0 x 2-7/8
320984	SS Large Screw Eye 4 x 2-3/16
320986	SS Large Screw Eye .162 x 1-5/8
321856	SS E&E Turnbuckle 10-24 x 1-5/8
321858	SS E&E Turnbuckle 1/4-20 x 2-1/8
321892	SS H&E Turnbuckle 10-24 x 1-5/8
321894	SS H&E Turnbuckle 1/4-20 x 2-1/8
321896	SS H&E Turnbuckle 3/8-16 x 3
322144	SS S-Hook .177 x 1-1/2
322146	SS S-Hook .250 x 2
322148	SS S-Hook .307 x 2-1/2
851845	SS Large Screw Eye .263 x 2-5/8
851878	SS S-Hook .307 x 3
996495	Panel 47–SS Turnbuckles-Scr Eyes-S Hooks



Wire Rope Clips & Thimbles

LARGE

Panel 30 — 996478

Total SKUs: 17

Part #	Description
852504	Wire Rope Clip Malleable/Zinc 1/16
321730	Wire Rope Clip Malleable/Zinc 1/8
321732	Wire Rope Clip Malleable/Zinc 3/16
321734	Wire Rope Clip Malleable/Zinc 1/4
321736	Wire Rope Clip Malleable/Zinc 5/16
321738	Wire Rope Clip Malleable/Zinc 3/8
321742	Wire Rope Clip Malleable/Zinc 1/2
321744	Wire Rope Clip Malleable/Zinc 5/8
321746	Wire Rope Clip Malleable/Zinc 3/4
322200	Wire Rope Thimble Steel/Zinc 1/8
322204	Wire Rope Thimble Steel/Zinc 3/16
322206	Wire Rope Thimble Steel/Zinc 1/4
322208	Wire Rope Thimble Steel/Zinc 5/16
322210	Wire Rope Thimble Steel/Zinc 3/8
322212	Wire Rope Thimble Steel/Zinc 1/2
322214	Wire Rope Thimble Steel/Zinc 5/8
322216	Wire Rope Thimble Steel/Zinc 3/4
996478	Panel 30 — Wire Rope Clips Large

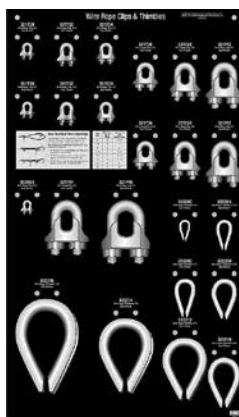

Welded Rings & Dees

Panel 31 — 996479

Total SKUs: 17

Part #	Description
321696	Welded Ring — Steel/Brass 7GA.x3/4
321698	Welded Ring — Steel/Brass 7GA.x1
321700	Welded Ring — Steel/Brass 7GA.x1-1/4
321702	Welded Ring — Steel/Brass 3GA.x1-1/2
321704	Welded Ring — Steel/Brass 2GA.x2
321706	Welded Ring — Steel/Brass 2GA.x2-1/2
321708	Welded Ring — Steel/Nickel 7GA.x3/4
321710	Welded Ring — Steel/Nickel 7GA.x1
321712	Welded Ring — Steel/Nickel 4GA.x1-1/4
321714	Welded Ring — Steel/Nickel 4GA.x1-1/2
321716	Welded Ring — Steel/Nickel 2GA.x2
321718	Welded Ring — Steel/Nickel 2GA.x2-1/2
321720	Welded Ring — Steel/Nickel 1GA.x3
321722	Welded Dee — Steel/Nickel 7/8
321724	Welded Dee — Steel/Nickel 1
321726	Welded Dee — Steel/Nickel 1-1/4
321728	Welded Dee — Steel/Nickel 1-1/2
996479	Panel 31 — Welded Rings & Dees

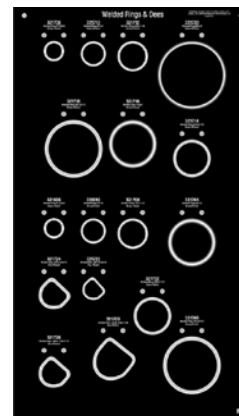

Bolt Snaps & Swivels

Panel 32 — 996480

Total SKUs: 20

Part #	Description
321420	Swivel Bolt Snap 3/8
321422	Swivel Bolt Snap 1/2
321424	Swivel Bolt Snap 5/8
321426	Swivel Bolt Snap 3/4
321428	Swivel Bolt Snap 1
321430	Swivel Bolt Snap 1-3/16
321432	Double End Bolt Snap 3-1/2
321434	Double End Bolt Snap 4
321436	Double End Bolt Snap 4-3/4
321438	Strap Rigid Bolt Snap 1
321440	Strap Swivel Bolt Snap 1
321442	Rigid Bolt Snap 5/8
321446	Swivel Trigger Snap 1/2
321448	Swivel Trigger Snap 3/4
321522	Open Rigid Bolt Snap 3/8
321524	Open Rigid Bolt Snap 1/2
321538	Double Open Eye Swivel
321540	Double Round Eye Swivel 5/8
321542	Double Strap Eye Swivel 1
321544	Double Round Eye Swivel 3/4
996480	Panel 32 — Bolt Snaps & Swivels

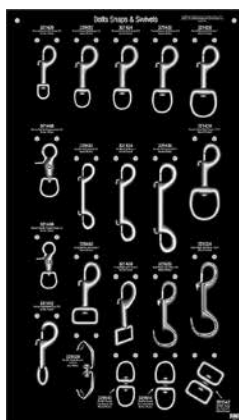

Spring & Animal Snaps

Panel 33 — 996481

Total SKUs: 22

Part #	Description
321444	Swivel Quick Snap 3/4
321450	Strap Swivel Spring Snap 5/8
321452	Strap Swivel Spring Snap 3/4
321454	Swivel Spring Snap 1/4
321456	Swivel Spring Snap 3/8
321458	Swivel Spring Snap 1/2
321460	Swivel Spring Snap 3/4
321462	Chain Snap 1 & 2
321464	Chain Snap 1/0 & 2/0
321466	Open Swivel Spring Snap 3/8
321468	Strap Rigid Spring Snap 3/4
321470	Strap Rigid Spring Snap 1
321474	Rope Snap 3/4
321476	Swivel Cap Snap 3/4
321478	Swivel Cap Snap 1
321480	Double End Cap Snap 3-7/8
321482	Round Rigid Snap Hook 5/8
321528	Swivel Animal Snap 7/8
321530	Swivel Animal Snap 1
321534	Breeching Snap 2-1/2
321536	Bit Snap 1-5/8
996481	Panel 33 — Spring & Animal Snaps



Brass Snaps

Panel 34 – 996482

Total SKUs: 21

Part #	Description
321484	Brass Swivel Bolt Snap 3/8
321486	Brass Swivel Bolt Snap 1/2
321490	Brass Swivel Bolt Snap 3/4
321492	Brass Swivel Bolt Snap 1
321494	Brass Swivel Bolt Snap 1-1/4
321496	Brass Open Rigid Bolt Snap 3/8
321498	Brass Double Bolt Snap 3-3/8
321500	Brass Double Bolt Snap 4-1/2
321502	Brass Rigid Quick Snap 3/8
321504	Brass Rigid Quick Snap 5/8
321506	Brass Rigid Quick Snap 11/16
321508	Brass Rigid Quick Snap 3/4
321510	Brass Swivel Quick Snap 5/8
321512	Brass Swivel Quick Snap 11/16
321514	Brass Swivel Quick Snap 3/4
321516	Brass Trigger Snap 1/2
852474	Brass Round Swivel Bolt Snap 13/16
852476	Brass Strap Swivel Bolt Snap 1/2
852478	Brass Strap Swivel Bolt Snap 1
852479	Brass Double Bolt Snap 4-1/8
852480	Brass Strap Swivel Trigger Snap 5/8
996482	Panel 34 – Solid Brass Snaps



Awning Pulleys

Panel 35 – 996483

Total SKUs: 16

Part #	Description
321570	Swivel Eye Single 1/2
321572	Swivel Eye Single 3/4
321574	Swivel Eye Single 1
321576	Swivel Eye Single 1-1/2
321578	Swivel Eye Single 2
321580	Rigid Eye Single 1/2
321582	Rigid Eye Single 3/4
321584	Rigid Eye Single 1
321586	Rigid Eye Single 1-1/2
321588	Rigid Eye Single 2
321592	Rigid Eye Double 3/4
321594	Rigid Eye Double 1
321596	Rigid Eye Double 1-1/2
321598	Swivel Eye Double 3/4
321600	Swivel Eye Double 1
321602	Swivel Eye Double 1-1/2
996483	Panel 35 – Awning Pulleys

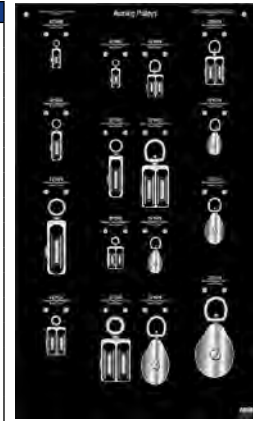

Heavy Duty Pulleys

Panel 36 – 996484

Total SKUs: 11

Part #	Description
852488	Heavy Duty Swivel Single Pulley 1-1/2
852489	Heavy Duty Swivel Single Pulley 2
852490	Heavy Duty Swivel Single Pulley 3
852491	Heavy Duty Rigid Single Pulley 1-1/2
852492	Heavy Duty Rigid Single Pulley 2
852493	Heavy Duty Rigid Single Pulley 3
852494	Heavy Duty Rigid Double Pulley 1-1/2
852497	Wall Ceiling Mount Pulley 1-1/2
852499	Heavy Duty Pulley Block & Tackle Set
852716	Heavy Duty Swivel Single Pulley 2-1/2
852717	Heavy Duty Rigid Single Pulley 2-1/2
996484	Panel 36 – Heavy Duty Pulleys

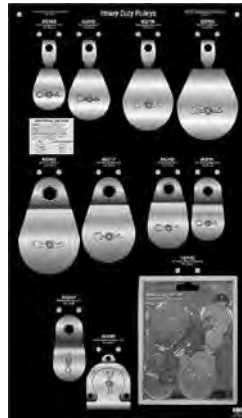

Forged Steel Eye Type Chain Hooks

Panel 37 – 996485

Total SKUs: 8

Part #	Description
321970	Frgd/Zinc Eye Type Grab Hook 1/4
321972	Frgd/Zinc Eye Type Grab Hook 5/16
321974	Frgd/Zinc Eye Type Grab Hook 3/8
321976	Frgd/Zinc Eye Type Grab Hook 1/2
321978	Frgd/Zinc Eye Type Slip Hook 1/4
321980	Frgd/Zinc Eye Type Slip Hook 5/16
321982	Frgd/Zinc Eye Type Slip Hook 3/8
321984	Frgd/Zinc Eye Type Slip Hook 1/2
996485	Panel 37 – Forged Eye Chain Hooks



Forged Steel Clevis Type Chain Hooks

Panel 38 – 996486

Total SKUs: 8

Part #	Description
321986	Frgd/Zinc Clevis Type Grab Hook 1/4
321988	Frgd/Zinc Clevis Type Grab Hook 5/16
321990	Frgd/Zinc Clevis Type Grab Hook 3/8
321994	Frgd/Zinc Clevis Type Grab Hook 1/2
321998	Frgd/Zinc Clevis Type Slip Hook 1/4
322000	Frgd/Zinc Clevis Type Slip Hook 5/16
322002	Frgd/Zinc Clevis Type Slip Hook 3/8
322004	Frgd/Zinc Clevis Type Slip Hook 1/2
996486	Panel 38 – Forged Clevis Chain Hooks



Chain Hooks with Latch

Panel 39 – 996487

Total SKUs: 9

Part #	Description
321482	Round Eye Rigid Snap Hook 5/8
321694	Scissor Hook Steel/Zinc 1/2
322006	Forged Hoist Hook 1 Ton
322008	Forged Hoist Hook 3/4 Ton
322010	Forged Hoist Hook 1-1/2 Ton
322012	Forged Hoist Hook 2 Ton
322067	Forged Clevis Slip Hook w/Latch 1/4
322068	Forged Clevis Slip Hook w/Latch 5/16
322069	Forged Clevis Slip Hook w/Latch 3/8
996487	Panel 39 – Chain Hooks w/Latches

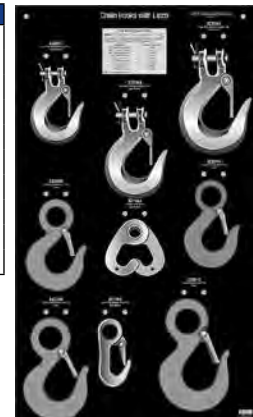

G70 Chain Hooks

Panel 40 – 996488

Total SKUs: 7

Part #	Description
322070	G70 Clevis Grab Hook 3/8
322071	G70 Clevis Grab Hook 5/16
322072	G70 Clevis Slip Hook 5/16
322073	G70 Clevis Slip Hook 3/8
322074	G70 Double Clevis Link 1/4 – 5/16
322075	G70 Double Clevis Link 3/8
322076	G70 Double Clevis Link 1/2
996488	Panel 40 – Forged G70 Chain Hooks

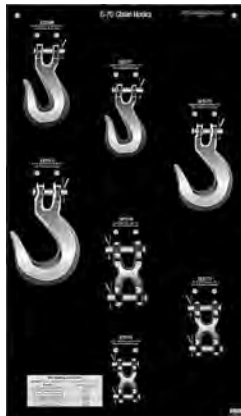

Forged Steel Connection Hardware – Galvanized

Panel 41 – 996489

Total SKUs: 19

Part #	Description
322028	Frgd/Galv Connecting Link 1/4
322030	Frgd/Galv Connecting Link 5/16
322032	Frgd/Galv Connecting Link 3/8
322036	Frgd/Galv Connecting Link 1/2
322038	Frgd/Galv Connecting Link 5/8
322040	Frgd/Galv Dble. Clevis Link 1/4-5/16
322042	Frgd/Galv Dble. Clevis Link 3/8
322044	Frgd/Galv Dble. Clevis Link 7/16-1/2
322046	Frgd/Galv Dble. Clevis Link 5/8
322048	Frgd/Galv Anchor Shackle 3/16
322050	Frgd/Galv Anchor Shackle 1/4
322052	Frgd/Galv Anchor Shackle 5/16
322054	Frgd/Galv Anchor Shackle 3/8
322056	Frgd/Galv Anchor Shackle 7/16
322058	Frgd/Galv Anchor Shackle 1/2
852451	Frgd/Galv Swivel 3/16
852452	Frgd/Galv Swivel 1/4
852453	Frgd/Galv Swivel 5/16
852454	Frgd/Galv Swivel 3/8
996489	Panel 41–Forg/Galv Connection Hdwe

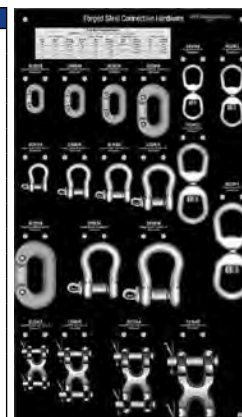

Links & Cold Shuts

Panel 42 – 996490

Total SKUs: 23

Part #	Description
321650	Safety Spring Snap Link 1/4
321652	Safety Spring Snap Link 5/16
321654	Safety Spring Snap Link 3/8
321656	Safety Spring Snap Link 7/16
321658	Safety Spring Snap Link 1/2
321660	Safety Spring Snap Link 5/8
321666	Quick Link 1/8
321670	Quick Link 3/16
321672	Quick Link 1/4
321674	Quick Link 5/16
321676	Quick Link 3/8
321678	Quick Link 1/2
321680	Quick Link 9/16
321682	Lap Link 1/8
321684	Lap Link 3/16
321686	Lap Link 1/4
321688	Lap Link 5/16
321690	Lap Link 3/8
322014	Cold Shut 3/16-1/8 Chain
322016	Cold Shut 1/4-3/16 Chain
322018	Cold Shut 5/16-1/4 Chain
322020	Cold Shut 3/8-5/16 Chain
322022	Cold Shut 7/16-3/8 Chain
996490	Panel 42 – Chain Links & Cold Shuts

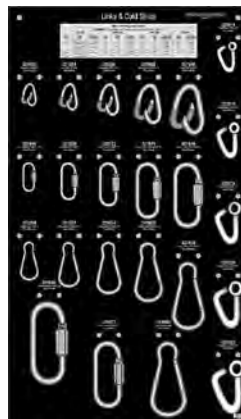

Rope Loops, Cleats, Clamps & Hooks

Panel 43 – 996491

Total SKUs: 22

Part #	Description
322300	Rope Cleat – Brass 2-7/16
322302	Rope Cleat – Brass 3-3/4
322304	Rope Cleat – Brass 4-3/8
322306	Rope Cleat – Brass 5-3/8
322308	Rope Cleat – Zinc Die Cast/Nickel 2-1/2
322310	Rope Cleat – Zinc Die Cast/Nickel 4-1/2
322312	Rope Cleat – Zinc Die Cast/Nickel 6
322316	Tarp Rope Hook Steel/Zinc .212
322318	Tarp Rope Hook Steel/Zinc .306
322320	Tarp Rope Hook Steel/Zinc .362
322322	Tarp Rope Hook Steel/Zinc .444
852022	Tarp Rope Hook Knob End
322324	Easy Knot Rope Tie Hook Steel/Zinc
852023	Strap Loop Nickel Plated 1
852712	Strap Loop Nickel Plated 1-1/4
852713	Strap Loop Nickel Plated 1-1/2
852024	Strap Loop Nickel Plated 2
852025	Rope Loop Nickel Plated 1/2
322314	Rope Tie Strap Steel/Zinc 3/8x2-1/4
852485	Rope Clamp .25-.37
852486	Rope Clamp .37-.50
852487	Brass Rope Clamp .43-.50
996491	Panel 43–Rope Clts-Clamps-Hks-Loops



Rope Accessories

Panel 44 – 996492

Total SKUs: 10

Part #	Description
322326	Clothesline Hook Plate Style
322328	Rope Binding Hook – Locking
322330	Rope Binding Hook – Snap Back
322332	Hammock Hook – Plate Style
322334	Hammock Hook – Lag Style
322336	Hitching Ring – Plate Style
322338	Hitching Ring – Machine Style 4"
322340	Hitching Ring – Machine Style 6"
322342	Hitching Ring – Lag Style 2" I.D.
322344	Hitching Ring – Lag Style 3" I.D.
996492	Panel 44 – Rope Accessories



Stainless Steel Links & Snaps

Panel 48 – 996496

Total SKUs: 14

Part #	Description
852026	Stainless Steel Snap Link 5/16
852027	Stainless Steel Snap Link 7/16
852028	Stainless Steel Snap Link 5/8
852029	Stainless Steel Snap Link 3/4
852030	Stainless Steel Quick Link 1/8
852031	Stainless Steel Quick Link 3/16
852032	Stainless Steel Quick Link 1/4
852033	Stainless Steel Quick Link 5/16
852034	Stainless Steel Quick Link 3/8
852465	SS Swivel Bolt Snap 1/2
852466	SS Swivel Bolt Snap 3/4
852467	SS Double Bolt Snap 4
852469	SS Rigid Quick Snap 3/4
852473	SS Rigid Spring Hook 1-1/8
996496	Panel 48 – SS Links & Snaps



Snaps

SMALL

Panel 49 – 996497

Total SKUs: 20

Part #	Description
321420	Swivel Bolt Snap 3/8
321422	Swivel Bolt Snap 1/2
321424	Swivel Bolt Snap 5/8
321426	Swivel Bolt Snap 3/4
321430	Swivel Bolt Snap 1-3/16
321432	Double End Bolt Snap 3-1/2
321434	Double End Bolt Snap 4
321436	Double End Bolt Snap 4-3/4
321440	Strap Swivel Bolt Snap 1
321442	Rigid Bolt Snap 5/8
321444	Swivel Quick Snap 3/4
321446	Swivel Trigger Snap 1/2
321448	Swivel Trigger Snap 3/4
321454	Round Swivel Spring Snap 1/4
321468	Strap Rigid Spring Snap 3/4
321478	Swivel Cap Snap 1
321528	Swivel Animal Snap 7/8
321530	Swivel Animal Snap 1
321534	Breeching Snap 2-1/2
321536	Bit Snap 1-5/8
996497	Panel 49 – Snaps Combination

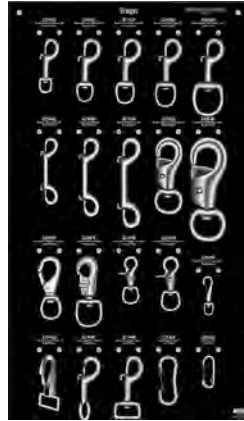

Lock Pins – Square, Round & Spring

Panel 59 – 996506

Total SKUs: 21

Part #	Description
883838	1/4 x 1-3/4 Round Lock Pin
882693	1/4 x 2 Round Lock Pin
883839	5/16 x 1-3/4 Round Lock Pin
882694	5/16 x 2-3/4 Round Lock Pin
883840	3/8 x 1-3/4 Round Lock Pin
882695	5/16 x 2-3/4 Square
882696	3/8 x 2-1/2 Square Lock Pin
882697	3/8 x 2-3/4 Square Lock Pin
967114	1/4 x 2-1/8 Spring Lock Pin
967113	5/16 x 2-1/4 Spring Lock Pin
967112	3/8 x 2-3/8 Spring Lock Pin
967111	1/2 x 4-1/2 Spring Lock Pin
967110	5/8 x 4-1/8 Spring Lock Pin
881128	3/16" Linch Pin - Zinc & Yellow
881129	1/4" Linch Pin - Zinc & Yellow
881130	5/16" Linch Pin - Zinc & Yellow
881131	7/16" Linch Pin - Zinc & Yellow
883507	7/16" 5pk Linch Pin - Zinc & Yellow
883508	7/16" 10pk Linch Pin - Zinc & Yellow
883509	7/16" Heavy Duty Linch Pin - Zinc & Yellow
883510	7/16" w/chain Linch Pin - Zinc & Yellow
996506	Panel 59 - Lock Pins Sq, Rd, Spring



Hitch Pins – Zinc & Yellow Part 1

Panel 55 – 996502

Total SKUs: 6

Part #	Description
881133	Hitch Pin - Zinc & Yellow 1/2 x 4
967105	Hitch Pin - Zinc & Yellow 5/8 x 6
881134	Hitch Pin - Zinc & Yellow 5/8 x 6-1/4
967106	Hitch Pin - Zinc & Yellow 3/4 x 4-1/4
881135	Hitch Pin - Zinc & Yellow 3/4 x 6-1/4
967107	Hitch Pin - Zinc & Yellow 3/4 x 6-1/4
996502	Panel 55 – Hitch Pins Z & Y

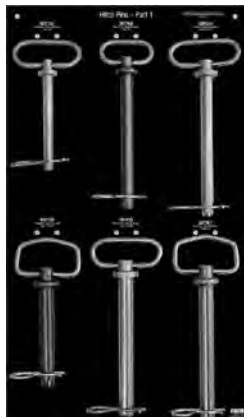

Hitch Pins – Zinc & Yellow Part 2

Panel 56 – 996503

Total SKUs: 7

Part #	Description
967108	Hitch Pin-Z & Y 7/8x6-1/4
967109	Hitch Pin-Z & Y 1x6-3/4
883841	Hitch Pin-Z & Y 3/8x4 Bent w/clip
883842	Hitch Pin-Z & Y 1/2x3 Bent w/clip
883843	Hitch Pin-Z & Y 1/2x4 Bent w/clip
881132	Hitch Pin-Z & Y 5/8x3 Bent w/clip
967099	Hitch Pin-Z & Y 5/8x4 Bent w/clip
996503	Panel 56 – Hitch Pins Z & Y Part2



Rubber Handled Hitch Pins – Part 1

Panel 57 – 996504

Total SKUs: 6

Part #	Description
881136	Rubber Handle 1/2 x 3-5/8
883831	Rubber Handle 5/8 x 4
967101	Rubber Handle 3/4 x 4
967102	Rubber Handle 3/4 x 6-1/2
883836	Rubber Handle 1-1/4 x 8-1/2
883837	Rubber Handle 1-1/2 x 8-1/2
996504	Panel 57 – Hitch Pins Rub Handle



Rubber Handled Hitch Pins – Part 2

Panel 58 – 996505

Total SKUs: 6

Part #	Description
967100	Rubber Handle 5/8 x 5-3/4
883832	Rubber Handle 7/8 x 4-1/4
967103	Rubber Handle 7/8 x 6-1/2
883833	Rubber Handle 1 x 4-3/4
883834	Rubber Handle 1 x 7-1/2
883835	Rubber Handle 1-1/8 x 8-1/2
996505	Panel 58 – Hitch Pins Rub Handle Pt 2



Shaft Collars & Machinery Bushings

Panel 60 – 996507

Total SKUs: 33

Part #	Description
883551	1/8 x 11/32 x 1/4
883552	3/16 x 7/16 x 1/4 Shaft Collars
838617	1/4 x 1/2 x 9/32 Shaft Collars
883553	5/16 x 5/8 x 5/16 Shaft Collars
838618	3/8 x 3/4 x 3/8 Shaft Collars
838619	7/16 x 7/8 x 7/16 Shaft Collars
838620	1/2 x 1 x 7/16 Shaft Collars
883554	9/16 x 1 x 7/16 Shaft Collars
838621	5/8 x 11/8 x 1/2 Shaft Collars
838622	3/4 x 1-1/4 x 9/16 Shaft Collars
883555	7/8 x 1-1/2 x 9/16 Shaft Collars
883556	1 x 1-5/8 x 5/8 Shaft Collars
883557	1/8" Double Split Shaft Collars
883558	3/16" Double Split Shaft Collars
883559	1/4" Double Split Shaft Collars
883560	5/16" Double Split Shaft Collars
883561	3/8" Double Split Shaft Collars
883562	7/16" Double Split Shaft Collars
883563	1/2" Double Split Shaft Collars
883564	9/16" Double Split Shaft Collars
883565	5/8" Double Split Shaft Collars
883566	3/4" Double Split Shaft Collars
883567	7/8" Double Split Shaft Collars
883568	1" Double Split Shaft Collars
883574	1/2 x 7/8 x 18Ga Machinery Bushings
883575	9/16 x 1 x 18Ga Machinery Bushings
882801	5/8 x 1 x 18Ga Machinery Bushings
882394	3/4 x 1-1/4 x 18Ga Machinery Bushings
882396	7/8 x 1-3/8 x 18Ga Machinery Bushings
882397	1 x 1-1/2 x 18Ga Machinery Bushings
883576	1-1/8 x 1-3/4 x 18Ga Machinery Bushings
883577	1-1/4 x 1-7/8 x 18Ga Machinery Bushings
883578	1-3/8 x 2-1/8 x 18Ga Machinery Bushings
996507	Panel 60 – Shaft Collars & Mach. Bush

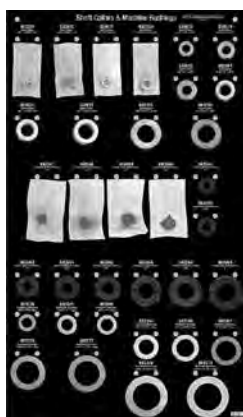

Metric Shaft Collars & Hitch Pin Clips

Panel 61 – 996508

Total SKUs: 35

Part #	Description
883693	M6 Metric Shaft Collars
883694	M8 Metric Shaft Collars
883695	M10 Metric Shaft Collars
883696	M12 Metric Shaft Collars
883697	M14 Metric Shaft Collars
883698	M16 Metric Shaft Collars
883699	M18 Metric Shaft Collars
883700	M20 Metric Shaft Collars
883701	M25 Metric Shaft Collars
883702	M6 Metric Double Split Shaft Collars
883703	M8 Metric Double Split Shaft Collars
883704	M10 Metric Double Split Shaft Collars
883705	M12 Metric Double Split Shaft Collars
883706	M14 Metric Double Split Shaft Collars
883707	M16 Metric Double Split Shaft Collars
883708	M18 Metric Double Split Shaft Collars
883709	M20 Metric Double Split Shaft Collars
883710	M25 Metric Double Split Shaft Collars
881095	.062 x 1-5/16 Hitch Pin Clips
881096	.093 x 1-5/8 Hitch Pin Clips
881097	.093 x 2-5/16 Hitch Pin Clips
882592	.093 x 2-1/2 Hitch Pin Clips
882593	.125 x 2-9/16 Hitch Pin Clips
881099	.125 x 1-15/16 Hitch Pin Clips
881098	.125 x 2-1/2 Hitch Pin Clips
881100	.148 x 2-15/16 Hitch Pin Clips
881102	.177 x 3-1/4 Hitch Pin Clips
881101	.177 x 3-3/4 Hitch Pin Clips
882594	.243 x 4 Hitch Pin Clips
881122	1/4 x 1-1/4 Cotterless Hitch Pins
881123	1/4 x 1-3/4 Cotterless Hitch Pins
881124	1/4 x 3 Cotterless Hitch Pins
881125	3/8 x 1-1/8 Cotterless Hitch Pins
881126	3/8 x 1-5/8 Cotterless Hitch Pins
881127	3/8 x 2-1/8 Cotterless Hitch Pins
996508	Panel 61–Metric Shaft Col & Hitch Pins



Blank Black Panel

Panel 50 – 996499

Part #	Description
996498	Panel 50 – Blank 12" x 21" Blk Panel

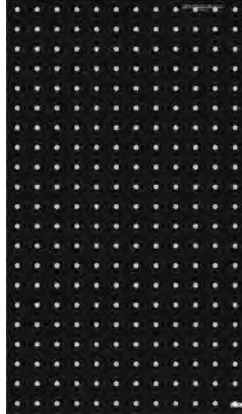

Blank Grey Panel

Panel 51 – 996501

Part #	Description
996499	Panel 51–Blank 12" x 21" Grey Panel

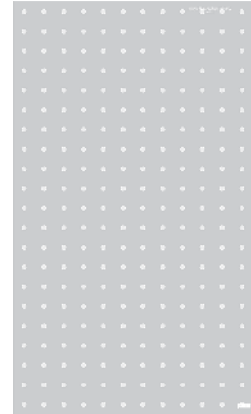

NOTES

Area for handwritten notes, consisting of multiple horizontal lines.

AN INTRODUCTION TO...

COMMERCIAL LETTERS, NUMBERS & SIGNS

LETTRES, CHIFFRES & AFFICHES COMMERCIAUX

...UNE INTRODUCTION.

www.hpaulin.com

For a full listing of Paulin®
Commercial Letters / Numbers /
Signs, please refer to our current
catalogue or visit our website to
download a PDF version.



**COMMERCIAL LETTERS,
NUMBERS & SIGNS**

**SELF ADHESIVE LETTERS &
NUMBERS REUSEABLE STENCILS**

SIGN PROGRAM

**SPECIALTY/NOVELTY SIGNS
& ACCESSORIES**



**COMMERCIAL LETTERS, NUMBERS & SIGNS
LETTRES, CHIFFRES ET AFFICHES COMMERCIAUX**

COMMERCIAL OPTIMIZER

No. 022-107

The perfect start to a Letters, Numbers and Signs Department. Utilizing just 4 feet of display area, space is “Optimized” by the use of one 3-sided merchandising tower and a cascading waterfall rack. The assortment offers coverage in fourteen different product categories.



COMMERCIAL LETTERS, NUMBERS & SIGNS MERCHANDISER PRÉSENTOIR LETTRES, CHIFFRES ET AFFICHES COMMERCIAUX

No. 022-107

Item Number	Size	Description	Pkg Qty	Qty Per Pack	Case Qty
839560	3"	DIE-CUT BLACK VINYL A	1	6	1200
839562	3"	DIE-CUT BLACK VINYL B	1	6	1200
839564	3"	DIE-CUT BLACK VINYL C	1	6	1200
839566	3"	DIE-CUT BLACK VINYL D	1	6	1200
839568	3"	DIE-CUT BLACK VINYL E	1	6	1200
839570	3"	DIE-CUT BLACK VINYL F	1	6	1200
839572	3"	DIE-CUT BLACK VINYL G	1	6	1200
839574	3"	DIE-CUT BLACK VINYL H	1	6	1200
839576	3"	DIE-CUT BLACK VINYL I	1	6	1200
839578	3"	DIE-CUT BLACK VINYL J	1	6	1200
839580	3"	DIE-CUT BLACK VINYL K	1	6	1200
839582	3"	DIE-CUT BLACK VINYL L	1	6	1200
839584	3"	DIE-CUT BLACK VINYL M	1	6	1200
839586	3"	DIE-CUT BLACK VINYL N	1	6	1200
839588	3"	DIE-CUT BLACK VINYL O	1	6	1200
839590	3"	DIE-CUT BLACK VINYL P	1	6	1200
839592	3"	DIE-CUT BLACK VINYL Q	1	6	1200
839594	3"	DIE-CUT BLACK VINYL R	1	6	1200
839596	3"	DIE-CUT BLACK VINYL S	1	6	1200
839598	3"	DIE-CUT BLACK VINYL T	1	6	1200
839600	3"	DIE-CUT BLACK VINYL U	1	6	1200
839602	3"	DIE-CUT BLACK VINYL V	1	6	1200
839604	3"	DIE-CUT BLACK VINYL W	1	6	1200
839606	3"	DIE-CUT BLACK VINYL X	1	6	1200
839608	3"	DIE-CUT BLACK VINYL Y	1	6	1200
839610	3"	DIE-CUT BLACK VINYL Z	1	6	1200
839612	3"	DIE-CUT BLACK VINYL 1	1	6	1200
839614	3"	DIE-CUT BLACK VINYL 2	1	6	1200
839616	3"	DIE-CUT BLACK VINYL 3	1	6	1200
839618	3"	DIE-CUT BLACK VINYL 4	1	6	1200
839620	3"	DIE-CUT BLACK VINYL 5	1	6	1200
839622	3"	DIE-CUT BLACK VINYL 6	1	6	1200
839624	3"	DIE-CUT BLACK VINYL 7	1	6	1200
839626	3"	DIE-CUT BLACK VINYL 8	1	6	1200
839628	3"	DIE-CUT BLACK VINYL 9	1	6	1200
839630	3"	DIE-CUT BLACK VINYL 0	1	6	1200
839632	3"	WHITE DIE CUT VINYL A	1	6	1200
839634	3"	WHITE DIE CUT VINYL B	1	6	1200
839636	3"	WHITE DIE CUT VINYL C	1	6	1200
839638	3"	WHITE DIE CUT VINYL D	1	6	1200
839640	3"	WHITE DIE CUT VINYL E	1	6	1200
839642	3"	WHITE DIE CUT VINYL F	1	6	1200
839644	3"	WHITE DIE CUT VINYL G	1	6	1200
839646	3"	WHITE DIE CUT VINYL H	1	6	1200
839648	3"	WHITE DIE CUT VINYL I	1	6	1200
839650	3"	WHITE DIE CUT VINYL J	1	6	1200
839652	3"	WHITE DIE CUT VINYL K	1	6	1200
839654	3"	WHITE DIE CUT VINYL L	1	6	1200
839656	3"	WHITE DIE CUT VINYL M	1	6	1200
839658	3"	WHITE DIE CUT VINYL N	1	6	1200
839660	3"	WHITE DIE CUT VINYL O	1	6	1200
839662	3"	WHITE DIE CUT VINYL P	1	6	1200

Item Number	Size	Description	Pkg Qty	Qty Per Pack	Case Qty
839664	3"	WHITE DIE CUT VINYL Q	1	6	1200
839666	3"	WHITE DIE CUT VINYL R	1	6	1200
839668	3"	WHITE DIE CUT VINYL S	1	6	1200
839670	3"	WHITE DIE CUT VINYL T	1	6	1200
839672	3"	WHITE DIE CUT VINYL U	1	6	1200
839674	3"	WHITE DIE CUT VINYL V	1	6	1200
839676	3"	WHITE DIE CUT VINYL W	1	6	1200
839678	3"	WHITE DIE CUT VINYL X	1	6	1200
839680	3"	WHITE DIE CUT VINYL Y	1	6	1200
839682	3"	WHITE DIE CUT VINYL Z	1	6	1200
839684	3"	WHITE DIE CUT VINYL 1	1	6	1200
839686	3"	WHITE DIE CUT VINYL 2	1	6	1200
839688	3"	WHITE DIE CUT VINYL 3	1	6	1200
839690	3"	WHITE DIE CUT VINYL 4	1	6	1200
839692	3"	WHITE DIE CUT VINYL 5	1	6	1200
839694	3"	WHITE DIE CUT VINYL 6	1	6	1200
839696	3"	WHITE DIE CUT VINYL 7	1	6	1200
839698	3"	WHITE DIE CUT VINYL 8	1	6	1200
839700	3"	WHITE DIE CUT VINYL 9	1	6	1200
839702	3"	WHITE DIE CUT VINYL 0	1	6	1200
839712	3"	G&B LETR ST-54 PC	1	5	60
839726	4"	PKGD STENCILS SET	1	5	30
839728	6"	PKGD STENCILS SET	1	5	30
839810	2" x 8"	MYL-ARROW	1	6	330
839812	2" x 8"	MYL-ENTRANCE	1	6	330
839814	2" x 8"	LADIES NICKEL BLACK/BLUE	1	6	330
839816	2" x 8"	MEN NICKEL BLACK/BLUE	1	6	330
839818	2" x 8"	MYL-KP DOOR CLSD	1	6	330
839824	2" x 8"	MYL-PUSH	1	6	330
839828	2" x 8"	MYL-PULL	1	6	330
839830	2" x 8"	MYL-BEWARE DOG	1	6	330
839832	2" x 8"	MYL-EMPLOYEE ONLY	1	6	330
839834	2" x 8"	MYL-EXIT	1	6	330
839836	2" x 8"	MYL-NO ADMITTNCE	1	6	330
839838	2" x 8"	MYL-NO SMOKING	1	6	330
839840	2" x 8"	MYL-NO SOLICITNG	1	6	330
839888	8" x 12"	PLS-R/B BUSINESS HR	1	6	450
839892	8" x 12"	PLS-R/B EXIT	1	6	450
839894	8" x 12"	PLS-R/B HELP WANTED	1	6	450
839896	8" x 12"	PLS-R/B NO SMOKING	1	6	450
839898	8" x 12"	PLS-R/B KEEP OUT	1	6	450
839900	8" x 12"	PLS-R/B NO DUMPING	1	6	450
839902	8" x 12"	PLS-R/B NO PARKING	1	6	450
839904	8" x 12"	PLS-R/B NO TRESPASS	1	6	450
839906	8" x 12"	PLS-R/B PRVT KP OUT	1	6	450
839908	8" x 12"	PLS-R/B PRVT PRPRT	1	6	450
839916	8" x 12"	PLS-R/B OPEN/CLOSED	1	6	450
839974	8" x 12"	PLS-R/B-DG HARD HAT	1	6	450
839976	8" x 12"	PLS-R/B-DG RESTRICT	1	6	450
839978	8" x 12"	PLS-R/B-DG HI VOLTG	1	6	450
839980	8" x 12"	PLS-B/Y-CN DO NT EN	1	6	450
839982	8" x 12"	PLS-B/Y-CN EY PRCTCT	1	6	450

COMMERCIAL LETTERS, NUMBERS & SIGNS MERCHANDISER PRÉSENTOIR LETTRES, CHIFFRES ET AFFICHES COMMERCIAUX

No. 022-107 - CONTINUED...

Item Number	Size	Description	Pkg Qty	Qty Per Pack	Case Qty
839984	8" x 12"	PLS-B/Y-CN HAZ MTRL	1	6	450
839986	8" x 12"	PLS-R/B-DG PROPANE	1	6	450
839989	8" x 12"	PLS-B/Y-CN FALL ICE	1	6	450
840014	18" x 12"	PLS-R/B-NO PARKING	1	5	60
840016	18" x 12"	PLS-G/W-VIST PRKNG	1	5	60
840022	18" x 12"	PLS-BU/W-HNDPCP PRK	1	5	60
840040	15" x 19"	PLS-R/B NO TRESPAS	1	6	120
840042	15" x 19"	PLS-R/B-KEEP OUT	1	6	120
840046	15" x 19"	PLS-R/B-OPEN/CLOSED	1	6	120
840068	36"	DRIVEWY MRKR-BLU	1	24	24
840070	36"	DRIVEWY MRKR-RED	1	24	24
840203	4x10	GID FIRE EX-RHT-ARW	1	10	300
840370		TAPE-REFLECT SAFETY STRIP	1	6	144
840378	24x2	REFL TAPE BLK/YELLW	1	5	35
840380	24x2	REFL TAPE RED/SILVR	1	5	45
840382	24x2	REFL TAPE SOL.SLVR	1	5	45
840384	24x2	REFL TAPE SOLID RED	1	5	35
840474	1-1/2"	ALU-A/C-BLK/GLD-#0	1	6	1500
840476	1-1/2"	ALU-A/C-BLK/GLD-#1	1	6	1500
840478	1-1/2"	ALU-A/C-BLK/GLD-#2	1	6	1500
840480	1-1/2"	ALU-A/C-BLK/GLD-#3	1	6	1500
840482	1-1/2"	ALU-A/C-BLK/GLD-#4	1	6	1500
840484	1-1/2"	ALU-A/C-BLK/GLD-#5	1	6	1500
840486	1-1/2"	ALU-A/C-BLK/GLD-#6	1	6	1500
840488	1-1/2"	ALU-A/C-BLK/GLD-#7	1	6	1500
840490	1-1/2"	ALU-A/C-BLK/GLD-#8	1	6	1500
840492	1-1/2"	ALU-A/C-BLK/GLD-#9	1	6	1500
840494	1-1/2"	ALU-A/C-BLK/GLD-A	1	6	1500
840496	1-1/2"	ALU-A/C-BLK/GLD-B	1	6	1500
840498	1-1/2"	ALU-A/C-BLK/GLD-C	1	6	1500
840500	1-1/2"	ALU-A/C-BLK/GLD-D	1	6	1500
840502	1-1/2"	ALU-A/C-BLK/GLD-E	1	6	1500
840504	1-1/2"	ALU-A/C-BLK/GLD-F	1	6	1500
840506	1-1/2"	ALU-A/C-BLK/GLD-G	1	6	1500
840508	1-1/2"	ALU-A/C-BLK/GLD-H	1	6	1500
840510	1-1/2"	ALU-A/C-BLK/GLD-I	1	6	1500
840512	1-1/2"	ALU-A/C-BLK/GLD-J	1	6	1500
840514	1-1/2"	ALU-A/C-BLK/GLD-K	1	6	1500
840516	1-1/2"	ALU-A/C-BLK/GLD-L	1	6	1500
840518	1-1/2"	ALU-A/C-BLK/GLD-M	1	6	1500
840520	1-1/2"	ALU-A/C-BLK/GLD-N	1	6	1500
840522	1-1/2"	ALU-A/C-BLK/GLD-O	1	6	1500
840524	1-1/2"	ALU-A/C-BLK/GLD-P	1	6	1500
840526	1-1/2"	ALU-A/C-BLK/GLD-Q	1	6	1500
840528	1-1/2"	ALU-A/C-BLK/GLD-R	1	6	1500
840530	1-1/2"	ALU-A/C-BLK/GLD-S	1	6	1500
840532	1-1/2"	ALU-A/C-BLK/GLD-T	1	6	1500
840534	1-1/2"	ALU-A/C-BLK/GLD-U	1	6	1500
840536	1-1/2"	ALU-A/C-BLK/GLD-V	1	6	1500
840538	1-1/2"	ALU-A/C-BLK/GLD-W	1	6	1500
840540	1-1/2"	ALU-A/C-BLK/GLD-X	1	6	1500
840542	1-1/2"	ALU-A/C-BLK/GLD-Y	1	6	1500

Item Number	Size	Description	Pkg Qty	Qty Per Pack	Case Qty
840544	1-1/2"	ALU-A/C-BLK/GLD-Z	1	6	1500
840546	1-1/2"	ALU-A/C-BLK/GLD-SP	1	6	1500
840548	1-1/2"	ALU-A/C-BLK/GLD-HY	1	6	1500
840550	1-1/2"	ALU-A/C-BLK/GLD-AM	1	6	1500
840552	3"	ANGLE CUT ALUM. #0	1	3	750
840554	3"	ANGLE CUT ALUM. #1	1	3	750
840556	3"	ANGLE CUT ALUM. #2	1	3	750
840558	3"	ANGLE CUT ALUM. #3	1	3	750
840560	3"	ANGLE CUT ALUM. #4	1	3	750
840562	3"	ANGLE CUT ALUM. #5	1	3	750
840564	3"	ANGLE CUT ALUM. #6	1	3	750
840566	3"	ANGLE CUT ALUM. #7	1	3	750
840568	3"	ANGLE CUT ALUM. #8	1	3	750
840570	3"	ANGLE CUT ALUM. #9	1	3	750
840628		SLOW MOVING VECH.SIGN	1	6	90
841744	3" x 9"	VIS-BLK EMPLOYE ONLY	1	6	192
841750	3" x 9"	VIS-BLK MEN	1	6	192
841752	3" x 9"	VIS-BLK NO SMOKING	1	6	192
841756	3" x 9"	VIS-BLK PRIVATE	1	6	192
841758	3" x 9"	VIS-BLK RESTROOMS	1	6	192
841762	3" x 9"	VIS-BLK WOMEN	1	6	192
842196	19" x 15"	PLS-SPC NO PARKING	1	6	60
842268	2"	MYL-B/G-PKGD-LTTRS	1	6	120
842270	2"	MYL-B/G-PKGD-NMBRS	1	6	120
842272	3"	VNL-B/W-PKGD-LTTRS	1	6	120
842274	3"	VNL-B/W-PKGD-NMBRS	1	6	120
842276	3"	MYL-B/G-PKGD-NMBRS	1	6	120
842282	2"	VNL-B/W-PKGD-LTTRS	1	6	120
842284	2"	VNL-B/W-PKGD-NMBRS	1	6	120
843444	3"	MYL-RFL-B/S-PKGD-LTTR	1	6	120
843445	3"	MYL-RFL-B/S-PKGD-# S	1	6	120
844010	3"	REFLCTR-RED-SCRW/ADH	1	6	120
844011	3"	REFLCTR-BLU-SCRW/ADH	1	6	120
844112	4 x 18"	ALU-R/W FIRE XTNGSH	1	6	240
844148	6" x 9"	SKO MEN ACCESS ADA	1	3	54
844149	6" x 9"	ADA-BRN MEN/WOMEN	1	3	54
844150	6" x 9"	ADA-BRN WOMEN PCTGRM	1	3	54
844151	6" x 9"	ADA-BLU ACCESSBL PIC	1	3	54
847004	2"	VNL-D/C-BLK-PKGD-L/#	1	6	120
847015	3"	VNL-D/C-BLK-PKGD-L/#	1	6	120
847026	2"	STENCILS-OILBD-LTR/#	1	6	108
847027	3"	STENCILS-OILBD-LTR/#	1	6	48
847201		REFLECTORS-SMALL CARDED	1	12	144
847212	1"	VNL-D/C-BLK-PKGD-L/#	1	6	120
848554	2" x 8"	MYL-B/S-EMRGNCY EXIT	1	6	330
848602		WET FLR A-FRME SGN-FRNCH	1	3	3
848629	1"	MYL-RFL-B/S-PKGD-L/#	1	6	120
848638	48"	REFLECTIVE STAFF-ORG	1	24	24
848739	5" x 7"	VIS-RED-EXTINCTEUR	1	6	150
848747	5" x 7"	VIS-RED-NO SMOKING	1	6	150
848765	48"	MKR-2SIDE-DRWWY-RED	1	24	1344
840271		911 ADDRESS KIT -DOUBLE SIDED	1	5	20

SELF-ADHESIVE LETTERS & NUMBERS REUSABLE STENCILS AUTO-ADHÉSIF LETTRES ET CHIFFRES POCHOIRS RÉUTILISABLES

The Hillman Sign Centre offers the convenience of packaged letters and numbers kits. Choose from several sizes in multiple colour combinations. Attractive black and gold angle-cut aluminium and mylar letters and numbers come in three sizes. Reflective Mylar letters and numbers are flexible, exceptionally durable with high tensile and tear strength, and won't fade in high temperatures.

FEATURING:

- Letters & Numbers Square Cut/Die Cut Kits
- Black on Gold Aluminium
- Die Cut Vinyl and Thin Styles
- Reusable Stencils: Letters/Numbers/Combo



SIGN PROGRAM PROGRAMME DE SIGNALISATION

- SELF-ADHESIVE
- STYRENE
- CORRUGATED
- ALUMINIUM

The Hillman Sign Center's signs are available in a variety of substrates, sizes and colour combinations. With a range of sign titles to choose from, meeting the specific needs of your customers is easy. All signs are made using ultra-violet, fluorescent ink for maximum visibility.

FEATURING:

- Self-Adhesive Mylar & Flexible Vinyl Signs
- Self-Adhesive Molded Plastic Signs
- Styrene Signs: 8" x 12" to 18" x 24"
- Corrugated Signs: 8" x 12" to 20" x 24"
- Aluminium Signs: 10" x 14" to 12" x 18"
- English and French Titles Available



SPECIALTY / NOVELTY SIGNS & ACCESSORIES
AFFICHES ET ACCESSOIRES DE SPÉCIALITÉ

The Hillman Sign Center offers a large variety of specialty and novelty signs for every type of customer. Create your own sign with our large selection of blank Create-A-Sign's in different shapes and colours. Safety tape, reflectors and sign frames are also available in a variety of sizes. LED Open sign, Solar Light bar and Glow-In-The-Dark signs add an extra benefit for your customer.

FEATURING:

- Create-A-Sign Program
- LED Open Sign and LED Solar Light Bar
- Safety Tape, Flagging Tape & Caution Tape
- Sign Frames and Reflectors



KEYS CLÈS



FOR MORE INFORMATION PLEASE CONTACT YOUR SALES REPRESENTATIVE

TRANSponderKEYS™
Automotive Security Keys

DON'T SEND YOUR CUSTOMERS AWAY TO AUTO DEALERS FOR TRANSponder KEYS!

- Made in minutes!
- Easy 2 button Operation.
- No internet required.
- High Retails with High Margins!
- Up to 90% Market Coverage of programmable keys.
- Compatible with any Hillman Key Duplication Platform.
- The Transponder Key Technology Market is growing.
- 9 of the top 10 selling vehicles in Canada are equipped with Transponder based security systems.
- More than 9 million vehicles on Canadian roads are equipped with Transponder Systems.



EZ CLONE PLUS

WHAT IS THE EZ CLONE PLUS SYSTEM?

It's the **critical** 2nd step to finalizing the duplication of automotive keys with Transponder Technology.



YOUR TRUSTED SOURCE FOR KEY DUPLICATION

Three levels of duplication to find the **RIGHT** solution for **YOUR MARKET**.

GOOD

Traditional Technology
Low Cost Operation
Manual Process



BETTER

Improved Technology
Market Leader in Key Duplication



BEST

THE NEXT GENERATION

- New Advanced Machine For Keys
- Laser Identification System
- Lowest Miscut Rate In The Industry
- Touch Screen Technology
- Maximize Store Profits
- 3 Easy Steps in Duplicating a Key
- Built-In Training Video & Application Guides



Precision 4 Laser (P4)

TECHNICAL TECHNIQUE

8.8HV

XYZ

**MECHANICAL REQUIREMENTS
FOR THREADED FASTENERS**

MECHANICAL REQUIREMENTS FOR THREADED FASTENERS FIXATIONS FILETÉES POUR APPLICATIONS MÉCANIQUES

S.A.E. GRADE (IMPERIAL)	I.S.O. CLASS (METRIC)	S.A.E & PAPCO IDENT.	BOLT SIZE DIAMETER (INCH or MM)	PROOF LOAD (PSI)	TENSILE STRENGTH MIN (PSI)	HARDNESS	
						ROCKWELL	VICKERS
INCH							
2			1/4 to 3/4 Over 3/4 to 1-1/2	55,000	74,000	B80-B100	
				33,000	60,000	B70-B100	
MATERIAL - HEAT TREATMENT	<ul style="list-style-type: none"> - Low or medium carbon steel; C: 0.15 to 0.55, P: 0.025 Max., S: 0.025 Max. - For studs only, sulfur content may be 0.33% maximum 						

S.A.E. GRADE (IMPERIAL)	I.S.O. CLASS (METRIC)	S.A.E & PAPCO IDENT.	BOLT SIZE DIAMETER (INCH or MM)	PROOF LOAD (PSI)	TENSILE STRENGTH MIN (PSI)	HARDNESS	
						ROCKWELL	VICKERS
INCH							
5			1/4 to 1 Over 1 to 1-1/2	85,000	120,00	C25-C34	
				74,000	105,000	C19-C30	
MATERIAL - HEAT TREATMENT	<ul style="list-style-type: none"> - Medium carbon steel quenched and tempered C: 0.28 to 0.55, P: 0.025 Max., S: 0.025 Max. Tempering Temperature: Min. 425 °C (800 °F) - For studs only, sulfur content may be 0.13% maximum - Medium carbon boron or medium carbon alloy steels, as specified for Grade 8 fasteners, may also be used at the manufacturer's option - There shall be a sufficient hardenability to ensure a microstructure consisting of approximately 90% martensite in the core of threaded sections of the fasteners after hardening and quenching and before tempering. 						
	<ul style="list-style-type: none"> - Carbon steel with additives (e.g. Boron or Cr or Mn) quenched and tempered C: 0.15 to 0.40, P: 0.025 Max., S: 0.025 Max., B: 0.0005 to 0.003 Tempering Temperature: Min. 425 °C (800 °F) - For studs only, sulfur content may be 0.13% maximum. When carbon content in boron steel is less than 0.25% the minimum manganese shall be 0.60% - There shall be a sufficient hardenability to ensure a microstructure consisting of approximately 90% martensite in the core of threaded sections of the fasteners after hardening and quenching and before tempering. 						

S.A.E. GRADE (IMPERIAL)	I.S.O. CLASS (METRIC)	S.A.E & PAPCO IDENT.	BOLT SIZE DIAMETER (INCH or MM)	PROOF LOAD (PSI)	TENSILE STRENGTH MIN (PSI)	HARDNESS	
						ROCKWELL	VICKERS
INCH							
8			1/4 to 1-1/2	120,000	150,000	C33-C39	
MATERIAL - HEAT TREATMENT	<ul style="list-style-type: none"> - Medium carbon steel quenched and tempered C: 0.25 to 0.55, P: 0.025 Max., S: 0.025 Max. Tempering Temperature: Min. 425 °C (800 °F) - For studs only, sulfur content may be 0.13% maximum - There shall be a sufficient hardenability to ensure a microstructure consisting of approximately 90% martensite in the core of threaded sections of the fasteners after hardening and quenching and before tempering. 						
	<ul style="list-style-type: none"> - Alloy steel with additives (e.g. Boron or Cr or Mn) quenched and tempered C: 0.20 to 0.55, P: 0.025 Max., S: 0.025 Max. Tempering Temperature: Min. 425 °C (800 °F) - For studs only, sulfur content may be 0.13% maximum - When carbon content in boron steel is less than 0.25% the minimum manganese shall be 0.70% - When boron is added the limits shall be 0.0005% to 0.003% - Alloy steel shall contain at least one of the following elements in the minimum quantity given: Chromium 0.30%, nickel 0.30%, molybdenum 0.20%, vanadium 0.10%, manganese 1.65%. Where elements are specified in combinations of two, three, four, or five and have alloy contents less than those given above, the limit value to be applied for steel class determination is 70% of sum of the individual limit values shown above for two, three, four or five elements concerned. - There shall be a sufficient hardenability to ensure a microstructure consisting of approximately 90% martensite in the core of threaded sections of the fasteners after hardening and quenching and before tempering. 						
	<ul style="list-style-type: none"> - Medium carbon alloy steel quenched and tempered C: 0.28 to 0.55, P: 0.025 Max., S: 0.025 Max. Tempering Temperature: Min. 425 °C (800 °F) - When carbon content in boron steel is less than 0.25% the minimum manganese shall be 0.70% - Alloy steel shall contain at least one of the following elements in the minimum quantity given: Chromium 0.30%, nickel 0.30%, molybdenum 0.20%, vanadium 0.10%, manganese 1.65%. Where elements are specified in combinations of two, three, four, or five and have alloy contents less than those given above, the limit value to be applied for steel class determination is 70% of sum of the individual limit values shown above for two, three, four or five elements concerned. - There shall be a sufficient hardenability to ensure a microstructure consisting of approximately 90% martensite in the core of threaded sections of the fasteners after hardening and quenching and before tempering. 						

MECHANICAL REQUIREMENTS FOR THREADED FASTENERS FIXATIONS FILETÉES POUR APPLICATIONS MÉCANIQUES

S.A.E. GRADE (IMPERIAL)	I.S.O. CLASS (METRIC)	S.A.E & PAPCO IDENT.	BOLT SIZE DIAMETER (INCH or MM)	PROOF LOAD (PSI)	TENSILE STRENGTH MIN (PSI)	HARDNESS	
						ROCKWELL	VICKERS
METRIC							
	8.8		M3 to M39	84,000 (580 MPa)	116,000 (800 MPa)	C22-C34	250-335
MATERIAL - HEAT TREATMENT	<ul style="list-style-type: none"> - Carbon steel with additives (e.g. Boron or Mn or Cr) quenched and tempered C: 0.15 to 0.40, P: 0.025 Max., S: 0.025 Max., B: 0.003 Max. Tempering Temperature: Min. 425 °C - In case of plain carbon boron steel with carbon content below 0.25% (cast analysis), the minimum manganese content shall be 0.6% - There shall be a sufficient hardenability to ensure a structure consisting of approximately 90% martensite in the core of threaded sections for fasteners in the "as-hardened" condition before tempering. 						
	<ul style="list-style-type: none"> - Carbon steel quenched and tempered C: 0.25 to 0.55, P: 0.025 Max., S: 0.025 Max., B: 0.003 Max. Tempering Temperature: Min. 425 °C - There shall be a sufficient hardenability to ensure a structure consisting of approximately 90% martensite in the core of threaded sections for fasteners in the "as-hardened" condition before tempering. 						
	<ul style="list-style-type: none"> - Alloy steel quenched and tempered C: 0.20 to 0.55, P: 0.025 Max., S: 0.025 Max., B: 0.003 Max. Tempering Temperature: Min. 425 °C - This alloy steel shall contain at least one of the following elements in the minimum quantity given: Chromium 0.30%, nickel 0.30%, molybdenum 0.20%, vanadium 0.10%. Where elements are specified in combinations of two, three or four and have alloy contents less than those given above, the limit value to be applied for steel class determination is 70% of sum of the individual limit values specified above for two, three or four elements concerned. - There shall be a sufficient hardenability to ensure a structure consisting of approximately 90% martensite in the core of threaded sections for fasteners in the "as-hardened" condition before tempering. 						

S.A.E. GRADE (IMPERIAL)	I.S.O. CLASS (METRIC)	S.A.E & PAPCO IDENT.	BOLT SIZE DIAMETER (INCH or MM)	PROOF LOAD (PSI)	TENSILE STRENGTH MIN (PSI)	HARDNESS	
						ROCKWELL	VICKERS
METRIC							
	9.8		M1.6 to M16	95,000 (650 MPa)	131,000 (900 MPa)	C28-C37	290-360
MATERIAL - HEAT TREATMENT	<ul style="list-style-type: none"> - Carbon steel with additives (e.g. Boron or Mn or Cr) quenched and tempered C: 0.15 to 0.40, P: 0.025 Max., S: 0.025 Max., B: 0.003 Max. Tempering Temperature: Min. 425 °C - In case of plain carbon boron steel with carbon content below 0.25% (cast analysis), the minimum manganese content shall be 0.7% - There shall be sufficient hardenability to ensure a structure consisting of approximately 90% martensite in the core of threaded sections for fasteners in the "as-hardened" condition before tempering. 						
	<ul style="list-style-type: none"> - Carbon steel quenched and tempered C: 0.25 to 0.55, P: 0.025 Max., S: 0.025 Max., B: 0.003 Max. Tempering Temperature: Min. 425 °C - There shall be a sufficient hardenability to ensure a structure consisting of approximately 90% martensite in the core of threaded sections for fasteners in the "as-hardened" condition before tempering. 						
	<ul style="list-style-type: none"> - Alloy steel quenched and tempered C: 0.20 to 0.55, P: 0.025 Max., S: 0.025 Max., B: 0.003 Max. Tempering Temperature: Min. 425 °C - This alloy steel shall contain at least one of the following elements in the minimum quantity given: Chromium 0.30%, nickel 0.30%, molybdenum 0.20%, vanadium 0.10%. Where elements are specified in combinations of two, three or four and have alloy contents less than those given above, the limit value to be applied for steel class determination is 70% of sum of the individual limit values specified above for two, three or four elements concerned. - There shall be a sufficient hardenability to ensure a structure consisting of approximately 90% martensite in the core of threaded sections for fasteners in the "as-hardened" condition before tempering. 						

MECHANICAL REQUIREMENTS FOR THREADED FASTENERS FIXATIONS FILETÉES POUR APPLICATIONS MÉCANIQUES

S.A.E. GRADE (IMPERIAL)	I.S.O. CLASS (METR)	S.A.E & PAPCO IDENT.	BOLT SIZE DIAMETER (INCH or MM)	PROOF LOAD (PSI)	TENSILE STRENGTH MIN (PSI)	HARDNESS	
						ROCKWELL	VICKERS
METRIC							
	10.9		M3 to M39	120,000 (830 MPa)	151,000 (1040 MPa)	C32-C39	320-380
MATERIAL - HEAT TREATMENT	<ul style="list-style-type: none"> - Carbon steel with additives (e.g. Boron or Mn or Cr) quenched and tempered C: 0.20 to 0.55, P: 0.025 Max., S: 0.025 Max., B: 0.003 Max. Tempering Temperature: Min. 425 °C - In case of plain carbon boron steel with carbon content below 0.25% (cast analysis), the minimum manganese content shall be 0.7% - There shall be sufficient hardenability to ensure a structure consisting of approximately 90% martensite in the core of threaded sections for fasteners in the "as-hardened" condition before tempering. 						
	<ul style="list-style-type: none"> - Carbon steel quenched and tempered C: 0.25 to 0.55, P: 0.025 Max., S: 0.025 Max., B: 0.003 Max. Tempering Temperature: Min. 425 °C - There shall be sufficient hardenability to ensure a structure consisting of approximately 90% martensite in the core of threaded sections for fasteners in the "as-hardened" condition before tempering. 						
	<ul style="list-style-type: none"> - Alloy steel quenched and tempered C: 0.20 to 0.55, P: 0.025 Max., S: 0.025 Max., B: 0.003 Max. Tempering Temperature: Min. 425 °C - This alloy steel shall contain at least one of the following elements in the minimum quantity given: Chromium 0.30%, nickel 0.30%, molybdenum 0.20%, vanadium 0.10%. Where elements are specified in combinations of two, three or four and have alloy contents less than those given above, the limit value to be applied for steel class determination is 70% of sum of the individual limit values specified above for two, three, four elements concerned. - There shall be a sufficient hardenability to ensure a structure consisting of approximately 90% martensite in the core of threaded sections for fasteners in the "as-hardened" condition before tempering. 						

IFI – Industrial Fasteners Institute

<http://www.indfast.org>

ASTM - American Society for Testing and Materials

<http://www.astm.org>

SAE - Society of Automotive Engineers

<http://www.sae.org>

AISI - American Iron and Steel Institute

<http://www.steel.org>

ASME - American Society of Mechanical Engineers

<https://www.asme.org>

JIS - Japanese Industrial Standards

<http://www.jisc.go.jp/eng>

ISO - International Organization for Standardization

<http://www.iso.org>

DIN - German Institute for Standardization

<http://www.din.de>



paulin®

Please visit our website to download the most current electronic catalogues or contact your sales representative to obtain printed copies.

www.hpaulin.com



papeco® FASTENER MEASUREMENT CHART

WOOD SCREWS VIS À BOIS

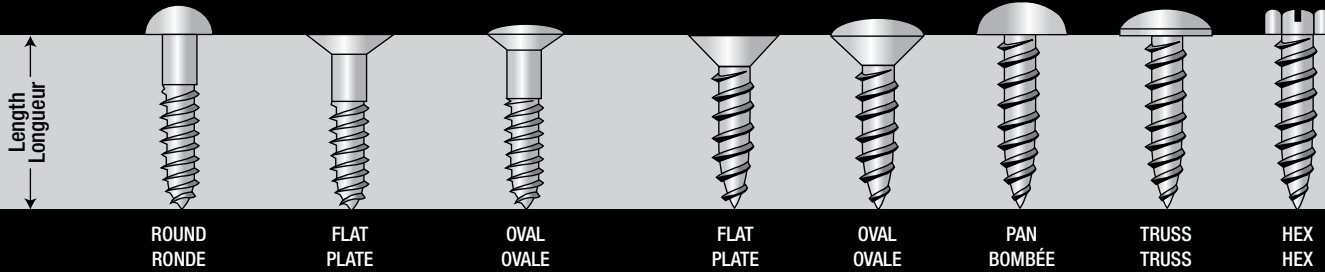

TAPPING SCREWS VIS TARAUDEUSES

MACHINE SCREWS VIS MÉCANIQUES

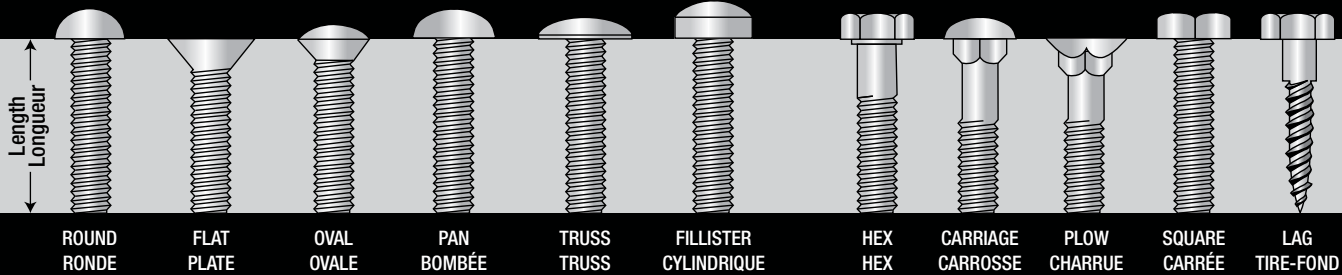

CAP SCREWS and BOLTS BOULONS et BOULONS DE PRÉCISION

SET SCREWS and STUDS VIS DE PRESSION et GOUJONS

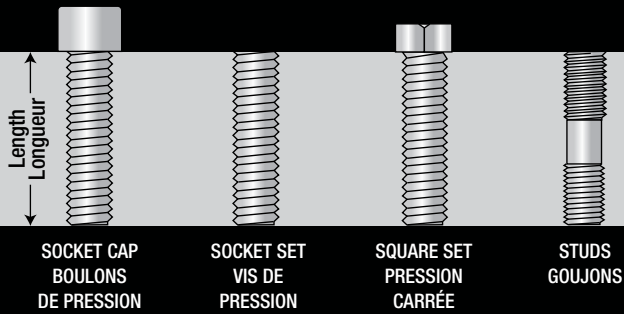

STANDARD PINS GOUPILLES REGULIERS

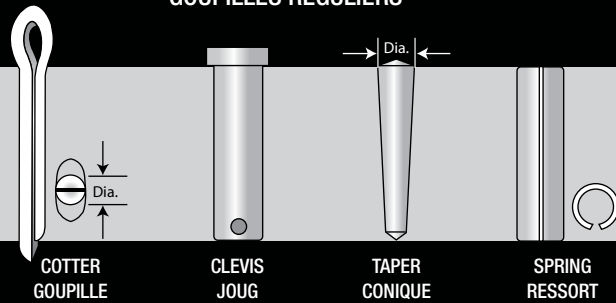

HEXAGON NUTS ÉCROUS HEXAGONAUX

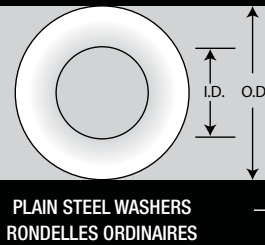
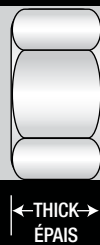
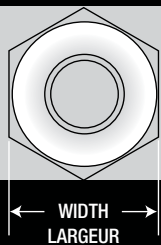

WASHERS RONDELLES

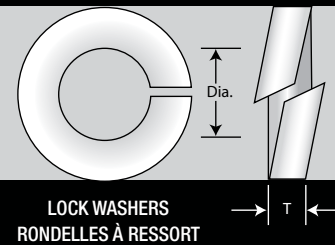

Laval
2591 Debray St.
Laval, QC H7S 2J4
Tel: 1-450-688-4292
Fax: 1-450-688-4750

Edmonton
11714-180th St.
Edmonton, AB T5S 1N7
Tel: 1-780-450-1346
Fax: 1-780-463-3597

Moncton
159 Henri Dunant St.
Moncton, NB E1E 1E4
Tel: 1-506-857-8658
Fax: 1-506-857-9338

Winnipeg
1670-A Inkster Blvd.
Winnipeg, MB R2X 2W8
Tel: 1-204-694-3802
Fax: 1-204-694-3804

Vancouver
3179 Thunderbird Cres.
Burnaby, BC V5A 3G1
Tel: 1-604-421-3096
Fax: 1-604-421-3046