

DYNALINE

Better products for all.

Merchandisers

Lubrication

Tow Pro

**Rigging &
Hardware**

Cargo Control

Shop Supplies

Boss

Custom Printing



PRODUCT CATALOGUE

www.dynaline.com

DYNALINE GROUP OF BRANDS



WHAT WE DO
Better products for all.

OUR MISSION
To supply consolidated product inventory to distributors of agricultural, industrial and automotive products across Canada. Dynaline is committed to the growth and sustainability of regional distributors through price guarantees, collaborative marketing partnerships, and ongoing support.

OUR TEAM
Committed to help regional distributors grow their business within their communities. We work hard to build tailored partnerships that serve our distributors well because we listen to what they need and are invested in helping their business grow.

OUR GOAL
To make it easier for you to grow the profitability of your business, by partnering with Canada's only single source supplier for branded tools, lighting and electrical, towing, lubrication, and safety products.

CONSOLIDATING YOUR SUCCESS

Better products for all.

Policies and Procedures:

Sales Policy:

Dynaline sells only to Authorized Distributors.

Freight:

Orders over \$1000 in net invoice value, will be shipped "Prepaid".

Warranty:

Products are guaranteed against defects in material and workmanship for One Year from Date of Purchase. Products that have been subjected to abuse will not be covered by warranty.

Returns:

All returns require a Return Goods Authorization Number (RGA), upon receipt. The product must be returned "Prepaid". Returns are subject to a 25% restocking charge.

Prices:

Are subject to change without notice.

Errors and Claims:

We accept responsibility for our errors, however we cannot assume responsibility for the errors of others.

All claims for shortages must be made within 10 days of shipment.

All claims for damages and shortages due to shipping and handling must be made to the carrier, as we are not responsible.

All claims for invoice errors must be made within 30 days.

Private Label and Dynaline Direct:

These items are not returnable.

Graphic approvals, once signed, are the responsibility of the customer.



Canadian-owned
Established in 1988



ISO 9001:2008
Quality Management System
CERT-0050960

MERCHANDISERS

Dynaline Merchandiser

Merchandiser Rack	1
Merchandiser Caster Wheels	1

Display Boards

Trailer Balls 12"x24"	2
Trailer Coupler 24"x24"	2
Brake Controller 24"x24"	2
Machinery Bushings 12"x24"	3
Bronze Bushings 12"x24"	3
Dynakit Assortments 12"x24"	4
Dynatray Assortments 24"x24" (x2)	4
SAE O-Rings 24"x24"	5
Grease Accessories 24"x24"	6
Springs Retail Packaged 24"x24" (x2)	7-8
Retainer Rings 24"x24"	9
Turnbuckles	10
Snaps 12"x24"	11
Padlocks 24"x24"	11
Snaps 24"x24"	12
Eyebolts 24"x24"	13
U-Bolts 24"x24"	14
Weather Caps 24"x24"	14
Pulleys	15
Pins 24"x24"	16
Tractor Linkage	17
Farm Packs 24"x24"	18
Muffler Clamps 24"x24"	18
Hitch Pins	19-20
Wire Rope Accessories	20-22
Chain Connectors 24"x24"	21
Chain Hooks 24"x24"	23
Schackles & Clevises 24"x24"	23

Universal Boards	25
Keystock	24

Plan-O-Grams

Assortments	26
Lubrication	26-29
Trailer & Towing	30-33
Caster Wheels	25
Cargo Control	35
General Hardware	36-37
Farm Hardware	38
O-Rings	39
Retainer Rings	40
Chain/Wire Racks	42-43
Wheel Rack	44-45
Storage Solutions (Tilt Bins)	44-45

Boss Merchandisers

Driver/Drill Bit Display	45-51
Magnifier Display	50
Carpenter Pencil Display	50

Dynaline Banner

Custom options	51
----------------------	----

Bulk Display

Bulk Display Shelf	39
Cable Reel Display	39

Boss End Cap Display

Three available builds	52-53
------------------------------	-------

Counter Top Display

3 Blade & Cutter Display	49
Blade & Cutter Display	49
Blade Display	49

DYNALINE'S MERCHANDISER PROGRAM

DYNALINE'S MERCHANDISERS

(Plan-o-grams and Display Boards)

are designed to help you drive sales.

They improve the visibility of product in your store and provide a clean and organized product presentation, at the same time, saving valuable retail space. They help you become recognized as the best supplier of these products in your area.

We are continually improving the product mix to ensure maximum results from our most popular items.



00024
(Rack Only)

We can help you:

- Customize your selection based on your market.
- Work together to make the product mix right for you.
- Assist with change over to our new merchandiser design.

Please contact us.
We are here to help you
grow your business.

Merchandiser Rack

Sturdy, free standing floor unit securely holds up to twelve 24" x 24" or up to twenty four 12" x 24" DYNALINE Board Merchandisers. Includes rack, assembly hardware & signage. Takes only 4 square feet of retail space.

Dimensions: 24" x 24" x 84". A real space saver!

PART#	CONTENTS
00024	Merchandiser Rack
00024-1	Set of 4 Caster Wheels. Swivel and Locking (optional)



Sizes are approximate. Specifications subject to change without notice.

DISPLAY BOARDS

Trailer Balls



PART#

CONTENTS

00208 Trailer Balls Display Board, 12" x 24"

00208K

Trailer Balls Merchandiser.
Includes 00208 display board, 12 pegs (80004) and product listed below:

PART#	DESCRIPTION	QTY.	PART#	DESCRIPTION	QTY.
11147P	1-7/8" Ball, 1" external thread	2 ea.	11154P	2-5/16" Ball, 1" external thread	2 ea.
11148P	1-7/8" Ball, 3/4" internal thread	2 ea.	11155P	2-5/16" Ball, 1-1/4" external thread	2 ea.
11149P	2" Ball, 3/4" internal thread	2 ea.	11155HP	2-5/16" Ball, 1-1/4" external thread, HD	2 ea.
11151P	1-7/8" Ball, 3/4" external thread	2 ea.	11155XP	2-5/16" Ball, 1-1/4" external thread, HD	2 ea.
11152P	2" Ball, 3/4" external thread	2 ea.	11251P	1-7/8" Ball, 3/4" external thread, long shank	1 ea.
11153P	2" Ball, 1" external thread	2 ea.	11252P	2" Ball, 3/4" external thread, long shank	1 ea.



Trailer Couplers



PART#

CONTENTS

00215 Trailer Couplers Display Board, 24" x 24"

00215K

Trailer Couplers Merchandiser.
Includes 00215 display board, 10 pegs (80004) and product listed below:

PART#	DESCRIPTION	QTY.	PART#	DESCRIPTION	QTY.
11156	For 1-7/8" Trailer Balls, 2" Channel	2 ea.	11159N	For 2" Trailer Balls, 2" Channel	1 ea.
11157	For 1-7/8" Trailer Balls, 2-1/2" Channel	2 ea.	11160	For 2" Trailer Balls, 3" Channel	2 ea.
11158	For 1-7/8" Trailer Balls, 3" Channel	2 ea.	11161	For 2" Trailer Balls	1 ea.
11159	For 2" Trailer Balls, 2-1/2" Channel	2 ea.	66276	Coupler Lock	2 ea.
			66277	Coupler and Receiver Lock Set	2 ea.



Brake Controllers



PART#

CONTENTS

01043 Brake Controllers Display Board, 24" x 24"

01043K

Brake Controllers Merchandiser.
Includes 01043 display board, 10 pegs (80004) and product listed below:

PART#	DESCRIPTION	QTY.	PART#	DESCRIPTION	QTY.
81725	Synchronizer Brake Controller	2 ea.	81788HBC	OEM Wiring Harness, Ford HD 2008-current	2 ea.
81741B	Energize III Brake Controller,	2 ea.	81789HBC	OEM Wiring Harness, 81789HBC Universal GM 2007-current	2 ea.
81780HBC	OEM Wiring Harness, GM 2003-2006	2 ea.	81790	Genesis Brake Controller with U-Bracket Mount	2 ea.
81782HBC	OEM Wiring Harness, Dodge/Chrysler 1996-current	2 ea.	81794HBC	OEM Wiring Harness, Ford F-150	2 ea.
81785HBC	OEM Wiring Harness, Toyota 2002-current	2 ea.			
81786HBC	OEM Wiring Harness, Nissan 2005-current	2 ea.			



Machinery Bushings

PART#

CONTENTS

00235 Machinery Bushings Display Board, 12" x 24"

00235K Machinery Bushings Merchandiser. Includes 00235 display board, 39 pegs (80004) and product listed below:

PART#	DESCRIPTION	QUANTITY	PART#	DESCRIPTION	QUANTITY
22700	M-16-L	1 pkg. of 10	22716	M-30-H	1 pkg. of 10
22701	M-18-L	1 pkg. of 10	22717	M-34-L	1 pkg. of 10
22702	M-18-M	1 pkg. of 10	22718	M-34-M	1 pkg. of 10
22703	M-20-L	1 pkg. of 10	22719	M-34-H	1 pkg. of 10
22704	M-20-M	1 pkg. of 10	22720	M-36-L	1 pkg. of 10
22705	M-20-H	1 pkg. of 10	22721	M-36-M	1 pkg. of 10
22706	M-22-L	1 pkg. of 10	22722	M-36-H	1 pkg. of 10
22707	M-22-M	1 pkg. of 10	22723	M-38-M	1 pkg. of 10
22708	M-24-L	1 pkg. of 10	22724	M-38-H	1 pkg. of 10
22709	M-24-M	1 pkg. of 10	22725	M-40-M	1 pkg. of 10
22710	M-24-H	1 pkg. of 10	22726	M-40-H	1 pkg. of 10
22711	M-28-L	1 pkg. of 10	22727	M-46-M	1 pkg. of 10
22712	M-28-M	1 pkg. of 10	22728	M-46-H	1 pkg. of 10
22713	M-28-H	1 pkg. of 10	22729	M-48-M	1 pkg. of 10
22714	M-30-L	1 pkg. of 10	22730	M-48-H	1 pkg. of 10
22715	M-30-M	1 pkg. of 10	22731	M-50-M	1 pkg. of 10



PART#	DESCRIPTION	QUANTITY
22732	M-50-H	1 pkg. of 10
22733	M-52-M	1 pkg. of 10
22734	M-52-H	1 pkg. of 10
22735	M-54-M	1 pkg. of 10
22736	M-54-H	1 pkg. of 10
22737	M-56-M	1 pkg. of 10
22738	M-56-H	1 pkg. of 10

Bronze Bushings

PART#

CONTENTS

00325 Bronze Bushings Display Board, 12" x 24"

00325K Bronze Bushings Merchandiser. Includes 00325 display board, 51 pegs (80004) and product listed below:

PART#	INS. DIA.	OUT. DIA.	QTY.	PART#	INS. DIA.	OUT. DIA.	QTY.
55300	1/4"	5/16"	2 ea.	55320	5/8"	7/8"	2 ea.
55301	1/4"	3/8"	2 ea.	55321	5/8"	1"	2 ea.
55302	1/4"	7/16"	2 ea.	55322	3/4"	7/8"	2 ea.
55303	1/4"	1/2"	2 ea.	55323	3/4"	15/16"	1 ea.
55304	5/16"	3/8"	2 ea.	55324	3/4"	1"	2 ea.
55305	5/16"	7/16"	2 ea.	55325	13/16"	1"	1 ea.
55306	3/8"	1/2"	2 ea.	55326	7/8"	1"	2 ea.
55307	3/8"	5/8"	2 ea.	55327	7/8"	1-1/8"	1 ea.
55308	3/8"	3/4"	2 ea.	55328	7/8"	1-1/4"	2 ea.
55309	7/16"	9/16"	1 ea.	55329	15/16"	1-1/4"	1 ea.
55310	7/16"	5/8"	2 ea.	55330	1"	1-1/4"	2 ea.
55311	1/2"	5/8"	2 ea.	55331	1"	1-3/8"	2 ea.
55312	1/2"	11/16"	2 ea.	55332	1"	1-1/2"	2 ea.
55313	1/2"	3/4"	2 ea.	55333	1-1/16"	1-5/16"	1 ea.
55314	1/2"	13/16"	2 ea.	55334	1-1/8"	1-1/4"	1 ea.
55315	1/2"	7/8"	2 ea.	55335	1-1/8"	1-3/8"	1 ea.
55316	9/16"	3/4"	2 ea.	55336	1-1/8"	1-1/2"	1 ea.
55317	9/16"	13/16"	2 ea.	55337	1-3/16"	1-7/16"	1 ea.
55318	5/8"	3/4"	2 ea.	55338	1-3/16"	1-1/2"	1 ea.
55319	5/8"	13/16"	2 ea.	55339	1-1/4"	1-1/2"	1 ea.

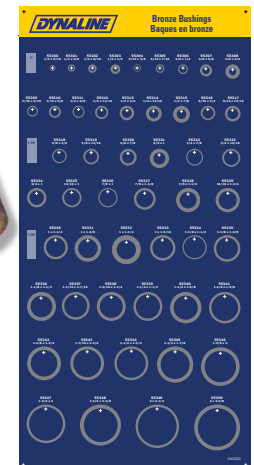

PART#	INS. DIA.	OUT. DIA.	QTY.
55340	1-1/4"	1-5/8"	1 ea.
55341	1-3/8"	1-5/8"	1 ea.
55342	1-3/8"	1-3/4"	1 ea.
55343	1-7/16"	1-3/4"	1 ea.
55344	1-1/2"	1-3/4"	1 ea.
55345	1-1/2"	1-7/8"	1 ea.
55346	1-5/8"	2"	1 ea.
55347	1-3/4"	2"	1 ea.
55348	1-3/4"	2-1/8"	1 ea.
55349	2"	2-1/4"	1 ea.
55350	2"	2-3/8"	1 ea.

Dynakit Assortments



PART#	CONTENTS	
00296	Dynakits Display Board (12" x 24")	
00296K	Dynakits Merchandiser. Includes 00296 display board, 16 pegs (80004) and product listed below:	
PART#	DESCRIPTION	QUANTITY
00140	Std. Plug-In Fuses	2 ea.
00141	Mini Plug-In Fuses	3 ea.
00160	Cotter Pins	4 ea.
00161	Cotter Pins (large)	3 ea.
00163	S.A.E. Grease Fittings	4 ea.
00164	Hair Pins Dynakit	4 ea.
00173	Spring Pins	4 ea.
00174	Woodruff Keys	2 ea.
00175	"E" Retainer Rings	1 ea.
00176	Int. Retainer Rings	1 ea.
00177	Ext. Retainer Rings	1 ea.
00178	Clevis Pins	1 ea.
00179	S.A.E. O-Ring Dynakit	2 ea.
00180	Keystock Dynakit	3 ea.
00181	Metric Grease Fittings	3 ea.
00182	Drive-In Grease Fittings	2 ea.

Dynatray Assortments



PART#	CONTENTS	
00031	Dynatrays Display Board (two, 24" x 24")	
00031K	Dynatrays Merchandiser. Includes 00031A, 00031B display boards, 20 pegs (80004) and product listed below:	
PART#	DESCRIPTION	QUANTITY
00108	Metric Grease Fitting Assortment	1 ea.
00112	S.A.E. Grease Fitting Assortment	1 ea.
10100	Springs Assortment	1 ea.
10101	HNBR O-Rings Assortment	1 ea.
10102	Cotter Pin Assortment	1 ea.
10103	Large Cotter Pin Assortment	1 ea.
10104	Ext. "E" Retainer Ring Assortment	1 ea.
10105	Hair Pins Assortment	1 ea.
10106	External Snap Rings Assortment	1 ea.
10107	Wire Terminal Assortment	1 ea.
10108	Grommets Assortment	1 ea.
10109	Grease Fitting Assortment	1 ea.
10110	Auto Fuse Assortment	1 ea.
10111	Wire Connectors Assortment	1 ea.
10112	Allen Cap Screws Assortment	1 ea.
10113	Woodruff Keys Assortment	1 ea.
10114	Copper Washers Assortment	1 ea.
10115	Rubber Sealing Washers Assortment	1 ea.
10117	Rivet Hardware Assortment	1 ea.
10118	Fuses Assortment	1 ea.

S.A.E. O-Rings

PART#			CONTENTS		
00318			O-Rings Display Board (24" x 24")		
00318K			O-Rings Merchandiser. Includes 00318 display board, 110 cornice hooks (65043) and product listed below:		
PART#	REF#	QUANTITY	PART#	REF#	QUANTITY
54006	006	1 pkg. of 15	54125	125	1 pkg. of 10
54007	007	1 pkg. of 15	54126	126	1 pkg. of 10
54008	008	1 pkg. of 15	54127	127	1 pkg. of 10
54009	009	1 pkg. of 15	54128	128	1 pkg. of 10
54010	010	1 pkg. of 15	54129	129	1 pkg. of 10
54011	011	1 pkg. of 15	54130	130	1 pkg. of 10
54012	012	1 pkg. of 15	54131	131	1 pkg. of 10
54013	013	1 pkg. of 10	54132	132	1 pkg. of 10
54014	014	1 pkg. of 10	54133	133	1 pkg. of 10
54015	015	1 pkg. of 10	54134	134	1 pkg. of 10
54016	016	1 pkg. of 10	54135	135	1 pkg. of 10
54017	017	1 pkg. of 10	54136	136	1 pkg. of 10
54018	018	1 pkg. of 10	54137	138	1 pkg. of 10
54019	019	1 pkg. of 10	54138	138	1 pkg. of 10
54020	020	1 pkg. of 10	54139	139	1 pkg. of 10
54021	021	1 pkg. of 10	54140	140	1 pkg. of 10
54022	022	1 pkg. of 10	54141	141	1 pkg. of 10
54023	023	1 pkg. of 10	54142	142	1 pkg. of 10
54024	024	1 pkg. of 10	54143	143	1 pkg. of 10
54025	025	1 pkg. of 10	54144	144	1 pkg. of 10
54026	026	1 pkg. of 10	54145	145	1 pkg. of 10
54027	027	1 pkg. of 10	54146	146	1 pkg. of 10
54028	028	1 pkg. of 10	54147	147	1 pkg. of 10
54110	110	1 pkg. of 15	54148	148	1 pkg. of 10
54111	111	1 pkg. of 15	54149	149	1 pkg. of 10
54112	112	1 pkg. of 15	54210	210	1 pkg. of 10
54113	113	1 pkg. of 15	54211	211	1 pkg. of 10
54114	114	1 pkg. of 15	54212	212	1 pkg. of 10
54115	115	1 pkg. of 15	54213	213	1 pkg. of 10
54116	116	1 pkg. of 15	54214	214	1 pkg. of 10
54117	117	1 pkg. of 10	54215	215	1 pkg. of 10
54118	118	1 pkg. of 10	54216	216	1 pkg. of 10
54119	119	1 pkg. of 10	54217	217	1 pkg. of 10
54120	120	1 pkg. of 10	54218	218	1 pkg. of 10
54121	121	1 pkg. of 10	54219	219	1 pkg. of 10
54122	122	1 pkg. of 10	54220	220	1 pkg. of 10
54123	123	1 pkg. of 10	54221	221	1 pkg. of 10
54124	124	1 pkg. of 10	54222	222	1 pkg. of 10



PART#	REF#	QUANTITY
54223	223	1 pkg. of 10
54224	224	1 pkg. of 10
54225	225	1 pkg. of 10
54226	226	1 pkg. of 10
54227	227	1 pkg. of 10
54228	228	1 pkg. of 10
54229	229	1 pkg. of 10
54230	230	1 pkg. of 10
54231	231	1 pkg. of 10
54232	232	1 pkg. of 10
54233	233	1 pkg. of 10
54234	234	1 pkg. of 10
54235	235	1 pkg. of 10
54236	236	1 pkg. of 10
54325	325	1 pkg. of 5
54326	326	1 pkg. of 5
54327	327	1 pkg. of 5
54328	328	1 pkg. of 5
54329	329	1 pkg. of 5
54330	330	1 pkg. of 5
54331	331	1 pkg. of 5
54332	332	1 pkg. of 5
54333	333	1 pkg. of 5
54334	334	1 pkg. of 5
54335	335	1 pkg. of 5
54336	336	1 pkg. of 5

For more details,
see Lubrication

Grease Accessories



PART#

CONTENTS

00527	Grease Accessories Display Board (24" x 24")
00527K	Grease Accessories Merchandiser. Includes 00057 display board, 41 pegs (80004) and product listed below:

PART#

DESCRIPTION

QUANTITY

00163	S.A.E. Grease Fittings Dynakit	3 ea.
00181	Metric Grease Fittings Dynakit	2 ea.
00182	Drive-In Grease Fittings Dynakit	2 ea.
11077	Grease Gun Holder Bracket	2 ea.
11122	Grease Injectors Dynapak, (3 pcs.), 10 ga.	6 pkgs. of 3
11140	Grease Hose, Plastic, 12", packaged	2 ea.
11141	Grease Hose, Plastic, 18", packaged	4 ea.
11071A	360 Degree Swivel Coupler, 1/8" NPT	2 ea.
11075A	Needle Nose Dispenser, 1-1/2"	4 ea.
11081A	90° Angle Grease Coupler	2 ea.
11100A	S.A.E. Grease Fittings Dynapak, 10 x 11100	6 pkgs. of 10
11102A	S.A.E. Grease Fittings Dynapak, 5 x 11102	2 pkgs. of 5
11104A	S.A.E. Grease Fittings Dynapak, 5 x 11104	4 pkgs. of 5
11105A	S.A.E. Grease Fittings Dynapak, 10 x 11105	4 pkgs. of 10
11106A	S.A.E. Grease Fittings Dynapak, 10 x 11106	2 pkgs. of 10
11107A	S.A.E. Grease Fittings Dynapak, 5 x 11107	2 pkgs. of 5
11109A	S.A.E. Grease Fittings Dynapak, 5 x 11109	2 pkgs. of 5
11110A	S.A.E. Grease Fittings Dynapak, 5 x 11110	2 pkgs. of 5
11112A	S.A.E. Grease Fittings Dynapak, 5 x 11112	2 pkgs. of 5
11113A	S.A.E. Grease Fittings Dynapak, 5 x 11113	2 pkgs. of 5
11114A	Metric Grease Fittings Dynapak, 5 x 11114	2 pkgs. of 5
11115A	Metric Grease Fittings Dynapak, 5 x 11115	2 pkgs. of 5
11116A	Metric Grease Fittings Dynapak, 5 x 11116	2 pkgs. of 5
11117A	Metric Grease Fittings Dynapak, 5 x 11117	2 pkgs. of 5
11118A	Metric Grease Fittings Dynapak, 5 x 11118	2 pkgs. of 5
11119A	Metric Grease Fittings Dynapak, 5 x 11119	2 pkgs. of 5
11120A	Metric Grease Fittings Dynapak, 5 x 11120	2 pkgs. of 5
11121A	Grease Coupler Dynapak, 1/8" NPT	6 ea.
11123A	Grease Injector, 18 ga.	2 ea.
11124A	Grease Injectors (2 sizes: 18 ga. & 21 ga.)	2 pkgs. of 2
11125A	Grease Couplers, 1/8" NPT, Heavy Duty	2 ea.
11126A	Metric Grease Fittings Dynapak, 5 x 11126	2 pkgs. of 5
11127A	Metric Grease Fittings Dynapak, 5 x 11127	2 pkgs. of 5
11131A	Drive-In Grease Fittings Dynapak, 5x11131	2 pkgs. of 5
11132A	Drive-In Grease Fittings Dynapak, 5x11132	2 pkgs. of 5
11133A	Drive-In Grease Fittings Dynapak, 5x11133	2 pkgs. of 5
11134A	Drive-In Grease Fittings Dynapak, 5x11134	2 pkgs. of 5
11135A	Drive-In Grease Fittings Dynapak, 5x11135	2 pkgs. of 10
11136A	Drive-In Grease Fittings Dynapak, 5x11136	2 pkgs. of 10
11142A	Grease Hose, Rubber, 12"	2 ea.
11143A	Grease Hose, Rubber, 18"	4 ea.

Sizes are approximate. Specifications subject to change without notice.

Springs - Retail Packaged

PART#	CONTENTS
00242	Springs Display Boards (two 24" x 24")
00242K	Springs Merchandiser. Includes 00242 display board, 100 pegs (80004) and product listed below:

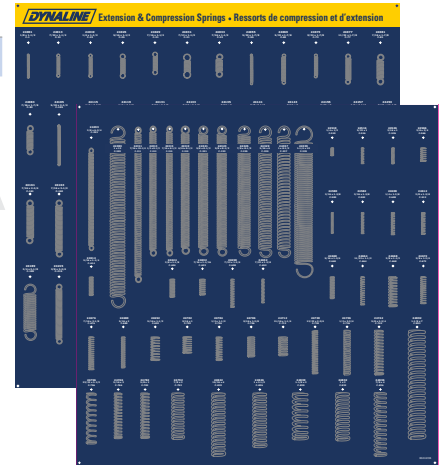

Extension Springs

PART#	REF#	QUANTITY	PART#	REF#	QUANTITY
24001	C-1	1 pkg. of 2	24157	C-157	1 pkg. of 2
24013	C-13	1 pkg. of 2	24161	C-161	1 pkg. of 2
24019	C-19	1 pkg. of 2	24163	C-163	1 pkg. of 2
24025	C-25	1 pkg. of 2	24165	C-165	1 pkg. of 2
24029	C-29	1 pkg. of 2	24171	C-171	1 pkg. of 2
24031	C-31	1 pkg. of 2	24173	C-173	1 pkg. of 2
24033	C-33	1 pkg. of 2	24175	C-175	1 pkg. of 2
24055	C-55	1 pkg. of 2	24177	C-177	1 pkg. of 2
24069	C-69	1 pkg. of 2	24179	C-179	1 pkg. of 2
24073	C-73	1 pkg. of 2	24181	C-181	1 pkg. of 2
24077	C-77	1 pkg. of 2	24183	C-183	1 pkg. of 2
24081	C-81	1 pkg. of 2	24187	C-187	1 pkg. of 2
24083	C-83	1 pkg. of 2	24189	C-189	1 pkg. of 2
24105	C-105	1 pkg. of 2	24215	C-215	1 pkg. of 2
24115	C-115	1 pkg. of 2	24219	C-219	1 pkg. of 2
24119	C-119	1 pkg. of 2	24231	C-231	1 pkg. of 2
24131	C-131	1 pkg. of 2	24239	C-239	1 pkg. of 2
24133	C-133	1 pkg. of 2	24243	C-243	1 pkg. of 2
24135	C-135	1 pkg. of 2	24253	C-253	1 ea.
24141	C-141	1 pkg. of 2	24259	C-259	1 pkg. of 2
24143	C-143	1 pkg. of 2	24261	C-261	2 ea.
24155	C-155	1 pkg. of 2	24265	C-265	2 ea.

PART#	REF#	QUANTITY
24269	C-269	2 ea.
24277	C-277	2 ea.
24293	C-293	2 ea.
24303	C-303	2 ea.
24311	C-311	2 ea.
24313	C-313	2 ea.
24315	C-315	2 ea.
24319	C-319	2 ea.
24321	C-321	2 ea.
24323	C-323	2 ea.
24325	C-325	2 ea.
24329	C-329	2 ea.
24337	C-337	2 ea.
24339	C-339	2 ea.

Compression Springs

PART#	REF#	QUANTITY	PART#	REF#	QUANTITY	PART#	REF#	QUANTITY
24510	C-510	1 pkg. of 6	24660	C-660	1 pkg. of 4	24736	C-736	1 pkg. of 2
24516	C-516	1 pkg. of 6	24664	C-664	1 pkg. of 4	24742	C-742	1 pkg. of 2
24526	C-526	1 pkg. of 6	24668	C-668	1 pkg. of 4	24756	C-756	1 pkg. of 2
24566	C-566	1 pkg. of 6	24672	C-672	1 pkg. of 4	24766	C-766	1 pkg. of 2
24580	C-580	1 pkg. of 6	24676	C-676	1 pkg. of 4	24782	C-782	1 pkg. of 2
24582	C-582	1 pkg. of 6	24680	C-680	1 pkg. of 4	24792	C-792	1 pkg. of 2
24608	C-608	1 pkg. of 4	24692	C-692	1 pkg. of 2	24822	C-822	1 pkg. of 2
24612	C-612	1 pkg. of 4	24702	C-702	1 pkg. of 2	24826	C-826	1 pkg. of 2
24614	C-614	1 pkg. of 4	24704	C-704	1 pkg. of 2	24830	C-830	1 pkg. of 2
24624	C-624	1 pkg. of 4	24706	C-706	1 pkg. of 2	24832	C-832	1 pkg. of 2
24632	C-632	1 pkg. of 4	24712	C-712	1 pkg. of 2	24836	C-836	1 pkg. of 2
24650	C-650	1 pkg. of 4	24730	C-730	1 pkg. of 2	24892	C-892	1 ea.
24652	C-652	1 pkg. of 4						

Springs - Expanded Selection

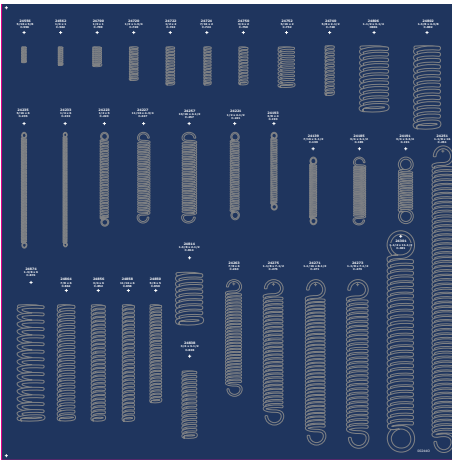

PART#	CONTENTS
00244	Springs Display Board (24" x 24")
00244K	Springs Merchandiser Expansion for 00242K. Includes 00242 display board, 34 pegs (80004) and product listed below:

Extension Springs

PART#	REF#	QUANTITY	PART#	REF#	QUANTITY
24139	C-139	1 pkg. of 2	24235	C-235	1 pkg. of 2
24185	C-185	1 pkg. of 2	24251	C-251	1 ea.
24191	C-191	1 pkg. of 2	24257	C-257	1 pkg. of 2
24193	C-193	1 pkg. of 2	24263	C-263	1 ea.
24221	C-221	1 pkg. of 2	24271	C-271	1 ea.
24223	C-223	1 pkg. of 2	24273	C-273	1 ea.
24227	C-227	1 pkg. of 2	24275	C-275	1 ea.
24233	C-233	1 pkg. of 2	24301	C-301	1 ea.

Compression Springs

PART#	REF#	QUANTITY	PART#	REF#	QUANTITY
24556	C-556	1 pkg. of 6	24802	C-802	1 ea.
24562	C-562	1 pkg. of 6	24806	C-806	1 ea.
24700	C-700	1 pkg. of 2	24814	C-814	1 ea.
24720	C-720	1 pkg. of 2	24838	C-818	1 pkg. of 2
24722	C-722	1 pkg. of 2	24850	C-850	1 pkg. of 2
24724	C-724	1 pkg. of 2	24856	C-856	1 pkg. of 2
24740	C-740	1 pkg. of 2	24858	C-858	1 pkg. of 2
24750	C-750	1 pkg. of 2	24864	C-864	1 ea.
24752	C-752	1 pkg. of 2	24874	C-874	1 ea.

Springs Merchandiser - Bulk



00243
PHOTO DISPLAY BOARD
24" X 24"

Easy to match photo board which shows springs at actual size.



PART#	CONTENTS
00243	Bulk Springs Display 24" x 24" Photo Board (features actual size photos)
00243K	Bulk Springs Assortment Merchandiser. A complete (900 pieces). Also includes cabinet, 4 drawers and 00243 Photo Display Board, 24" x 24".
00243C	Cabinet Only. Cabinet size is 20" wide x 14-1/2" high x 15-3/4" deep.

- Drawers with lids easily pull open
- Bulk Springs Merchandisers take up less space than packaged springs
- Cabinet holds 100 types of springs

Complete listing of BULK SPRINGS in the Shop Supplies Catalogue

Illustrations or photos may not be exactly as shown.

Retainer Rings

PART#	CONTENTS		
00245	Retainer Rings Display Board, 24" x 24"		
	Retainer Rings Merchandiser.		
00245K	Includes 00245 display board, cornice hooks (65043) and product listed below:		
PART#	DESCRIPTION	REF.#	QUANTITY
22861	"E" type, 3/16"	R1000-018	1 pkg. of 10
22862	"E" type, 1/4"	R1000-025	1 pkg. of 10
22863	"E" type, 5/16"	R1000-031	1 pkg. of 10
22864	"E" type, 3/8"	R1000-037	1 pkg. of 10
22865	"E" type, 7/16"	R1000-043	1 pkg. of 10
22866	"E" type, 1/2"	R1000-050	1 pkg. of 10
22867	"E" type, 5/8"	R1000-062	1 pkg. of 10
22868	"E" type, 3/4"	R1000-075	1 pkg. of 10
22869	"E" type, 7/8"	R1000-087	1 pkg. of 10
22870	"E" type, 63/64"	R1000-098	1 pkg. of 10
22871	"E" type, 1-3/16"	R1000-118	1 pkg. of 10
22872	"E" type, 1-3/8"	R1000-137	1 pkg. of 10
22873	Int., 1/4"	R3000-025	1 pkg. of 10
22874	Int., 5/16"	R3000-031	1 pkg. of 10
22875	Int., 3/8"	R3000-037	1 pkg. of 10
22876	Int., 7/16"	R3000-043	1 pkg. of 10
22878	Int., 1/2"	R3000-050	1 pkg. of 10
22879	Int., 9/16"	R3000-056	1 pkg. of 10
22880	Int., 5/8"	R3000-062	1 pkg. of 10
22881	Int., 11/16"	R3000-068	1 pkg. of 10
22882	Int., 3/4"	R3000-075	1 pkg. of 10
22884	Int., 7/8"	R3000-087	1 pkg. of 10
22885	Int., 15/16"	R3000-093	1 pkg. of 10
22886	Int., 1"	R3000-100	1 pkg. of 10
22888	Int., 1-1/16"	R3000-106	1 pkg. of 10
22889	Int., 1-1/8"	R3000-112	1 pkg. of 10
22890	Int., 1-3/16"	R3000-118	1 pkg. of 10
22891	Int., 1-1/4"	R3000-125	1 pkg. of 10
22892	Int., 1-5/16"	R3000-131	1 pkg. of 10
22893	Int., 1-3/8"	R3000-137	1 pkg. of 10
22894	Int., 1-7/16"	R3000-143	1 pkg. of 10
22895	Int., 1-1/2"	R3000-150	1 pkg. of 10
22896	Int., 1-9/16"	R3000-156	1 pkg. of 10
22897	Int., 1-5/8"	R3000-162	1 pkg. of 10
22900	Int., 1-3/4"	R3000-175	1 pkg. of 10
22901	Int., 1-13/16"	R3000-181	1 pkg. of 10
22902	Int., 1-7/8"	R3000-187	1 pkg. of 10
22903	Int., 1-15/16"	R3000-193	1 pkg. of 10
22904	Int., 2"	R3000-200	1 pkg. of 10
22905	Int., 2-1/16"	R3000-206	1 pkg. of 5
22906	Int., 2-1/8"	R3000-212	1 pkg. of 5

PART#	DESCRIPTION	REF.#	QUANTITY
22907	Int., 2-1/4"	R3000-225	1 pkg. of 5
22908	Int., 2-3/8"	R3000-237	1 pkg. of 5
22909	Int., 2-7/16"	R3000-244	1 pkg. of 5
22910	Int., 2-1/2"	R3000-250	1 pkg. of 5
22912	Int., 2-11/16"	R3000-268	1 pkg. of 5
22913	Int., 2-3/4"	R3000-275	1 pkg. of 5
22914	Int., 2-13/16"	R3000-281	1 pkg. of 5
22916	Int., 3"	R3000-300	1 pkg. of 2
22926	Ext., 5/16"	R3100-031	1 pkg. of 10
22928	Ext., 3/8"	R3100-037	1 pkg. of 10
22929	Ext., 7/16"	R3100-043	1 pkg. of 10
22931	Ext., 1/2"	R3100-050	1 pkg. of 10
22932	Ext., 9/16"	R3100-056	1 pkg. of 10
22933	Ext., 19/32"	R3100-059	1 pkg. of 10
22934	Ext., 5/8"	R3100-062	1 pkg. of 10
22935	Ext., 5/8"	R3100-066	1 pkg. of 10
22936	Ext., 11/16"	R3100-068	1 pkg. of 10
22937	Ext., 3/4"	R3100-075	1 pkg. of 10
22938	Ext., 13/16"	R3100-081	1 pkg. of 10
22939	Ext., 7/8"	R3100-087	1 pkg. of 10
22940	Ext., 15/16"	R3100-093	1 pkg. of 10
22942	Ext., 1"	R3100-100	1 pkg. of 10
22944	Ext., 1-1/16"	R3100-106	1 pkg. of 10
22945	Ext., 1-1/8"	R3100-112	1 pkg. of 10
22946	Ext., 1-3/16"	R3100-118	1 pkg. of 10
22947	Ext., 1-1/4"	R3100-125	1 pkg. of 10
22948	Ext., 1-5/16"	R3100-131	1 pkg. of 10
22949	Ext., 1-3/8"	R3100-137	1 pkg. of 10
22950	Ext., 1-7/16"	R3100-143	1 pkg. of 10
22951	Ext., 1-1/2"	R3100-150	1 pkg. of 10
22952	Ext., 1-9/16"	R3100-156	1 pkg. of 10
22953	Ext., 1-5/8"	R3100-162	1 pkg. of 10
22954	Ext., 1-11/16"	R3100-168	1 pkg. of 10
22955	Ext., 1-3/4"	R3100-175	1 pkg. of 10
22956	Ext., 1-7/8"	R3100-187	1 pkg. of 10
22957	Ext., 1-31/32"	R3100-196	1 pkg. of 10
22958	Ext., 2"	R3100-200	1 pkg. of 10
22960	Ext., 2-1/8"	R3100-212	1 pkg. of 5
22962	Ext., 2-1/4"	R3100-225	1 pkg. of 5
22963	Ext., 2-3/8"	R3100-237	1 pkg. of 5
22964	Ext., 2-7/16"	R3100-243	1 pkg. of 5
22965	Ext., 2-1/2"	R3100-250	1 pkg. of 5
22966	Ext., 2-5/8"	R3100-262	1 pkg. of 5
22967	Ext., 2-3/4"	R3100-275	1 pkg. of 2
22968	Ext., 2-7/8"	R3100-287	1 pkg. of 2
22970	Ext., 3"	R3100-300	1 pkg. of 2

Turnbuckles - General Purpose

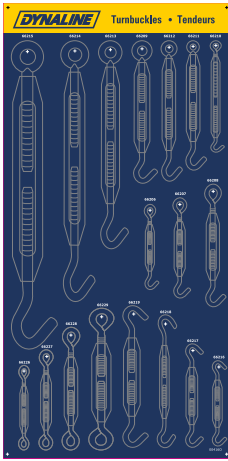

PART#	DESCRIPTION	QUANTITY
66206	Hook & Eye, 7/32"	1 pkg. of 10
66207	Hook & Eye, 1/4"	1 pkg. of 10
66208	Hook & Eye, 5/16"	1 pkg. of 10
66209	Hook & Eye, 3/8"	1 pkg. of 10
66210	Hook & Eye, 6mm	2 ea.

PART#	CONTENTS
00416	Turnbuckles Display Board (12" x 24")
00416K	General Purpose Turnbuckles Merchandiser. Includes 00416 display board, 19 pegs (80004) and product listed below:

PART#	DESCRIPTION	QUANTITY
66211	Hook & Eye, 8mm	2 ea.
66212	Hook & Eye, 10mm	2 ea.
66213	Hook & Eye, 12mm	2 ea.
66214	Hook & Eye, 16mm	2 ea.
66215	Hook & Eye, 20mm	2 ea.
66216	Hook & Hook, 7/32"	1 pkg. of 10
66217	Hook & Hook, 1/4"	1 pkg. of 10
66218	Hook & Hook, 5/16"	1 pkg. of 10
66219	Hook & Hook, 3/8"	1 pkg. of 10
66226	Eye & Eye, 7/32"	1 pkg. of 10
66227	Eye & Eye, 1/4"	1 pkg. of 10
66228	Eye & Eye, 5/16"	1 pkg. of 10
66229	Eye & Eye, 3/8"	1 pkg. of 10

Turnbuckles - Forged Steel

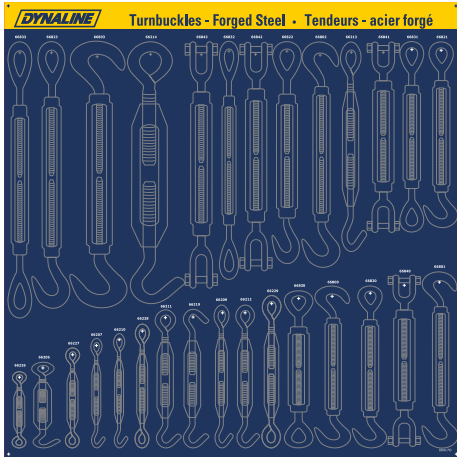

PART#	DESCRIPTION	QUANTITY
66206	Hook & Eye, 7/32"	1 pkg. of 10
66207	Hook & Eye, 1/4"	1 pkg. of 10
66209	Hook & Eye, 3/8"	1 pkg. of 10
66210	Hook & Eye, 6mm	2 ea.
66211	Hook & Eye, 8mm	2 ea.
66212	Hook & Eye, 10mm	2 ea.
66213	Hook & Eye, 12mm	2 ea.
66214	Hook & Eye, 16mm	2 ea.
66219	Hook & Hook, 3/8"	1 pkg. of 10
66226	Eye & Eye, 7/32"	1 pkg. of 10

PART#	CONTENTS
00417	Forged Steel Turnbuckles Display Board (24" x 24")
00417K	Forged Steel Turnbuckles Merchandiser. Includes 00417 display board, 30 pegs (80004) and product listed below:

PART#	DESCRIPTION	QUANTITY
66227	Eye & Eye, 1/4"	1 pkg. of 10
66228	Eye & Eye, 5/16"	1 pkg. of 10
66229	Eye & Eye, 3/8"	1 pkg. of 10
66800	Hook & Hook, 1/4" x 4"	2 ea.
66801	Hook & Hook, 5/16" x 4-1/2"	2 ea.
66802	Hook & Hook, 3/8" x 6"	2 ea.
66803	Hook & Hook, 1/2" x 6"	2 ea.
66820	Hook & Eye, 1/4" x 4"	2 ea.
66821	Hook & Eye, 5/16" x 4-1/2"	2 ea.
66822	Hook & Eye, 3/8" x 6"	2 ea.
66823	Hook & Eye, 1/2" x 6"	2 ea.
66830	Eye & Eye, 1/4" x 4"	2 ea.
66831	Eye & Eye, 5/16" x 4-1/2"	2 ea.
66832	Eye & Eye, 3/8" x 6"	2 ea.
66833	Eye & Eye, 1/2" x 6"	2 ea.
66840	Jaw & Jaw, 1/4" x 4"	2 ea.
66841	Jaw & Jaw, 5/16" x 4-1/2"	2 ea.
66842	Jaw & Jaw, 3/8" x 6"	2 ea.
66843	Jaw & Jaw, 1/2" x 6"	2 ea.

Snaps

PART#	CONTENTS
00447	Snaps Display Board (12" x 24")
00447K	Snaps Merchandiser. Includes 00447 display board, 33 pegs (80004) and product listed below:

PART#	DESCRIPTION	QUANTITY
64072	Stainless Steel Snap Link, 5/16"	1 pkg. of 5
66331	Solid Snap Hook, 11/16"	1 pkg. of 5
66334	Swivel Eye Snap, 11/16"	1 pkg. of 5
66335	Swivel Eye Snap, 13/16"	1 pkg. of 5
66336	Dog Lead Snap, 3/8"	1 pkg. of 5
66338	Panic Snap, 1/2"	1 pkg. of 5
66339	Trigger Snap, 5/8"	1 pkg. of 5
66340	Bolt Snap, 11/16"	1 pkg. of 5
66341	Open Eye Snap, 13/16"	1 pkg. of 5
66343	Bolt Snap, 3/4"	1 pkg. of 5
66344	Trigger Snap, 3/4"	1 pkg. of 5
66348	Square Trigger Snap, 3/4"	1 pkg. of 5
66350	Trigger Snap, 13/16"	1 pkg. of 5
66354	Mini Bolt Snap, 7/16"	1 pkg. of 5
66360	Solid Brass Bolt Snap, 1/2" x 3"	1 pkg. of 5
66361	Brass Bolt Snap, 1"	1 pkg. of 5
66365	Baby Square Eye Snap, 5/8"	1 pkg. of 5
66366	Bolt Snap, 3-1/4"	1 pkg. of 5



PART#	DESCRIPTION	QUANTITY
66374	Lever Snap, 5/8"	1 pkg. of 5
66375	Lever Snap, 3/4"	1 pkg. of 5
66376	Lever Snap, 1"	1 pkg. of 5
66377	Lever Snap, 1-1/8"	1 pkg. of 5
66380	Security Snap, 7/8"	1 pkg. of 5
66381	Security Snap Hook, 7/8"	1 pkg. of 5
66387	Swivel Simplex Spring Snap, 1/2"	1 pkg. of 5
66427	Aluminum Snap Hook, 3/16"	1 pkg. of 10
66428	Aluminium Snap Hook, 1/4"	1 pkg. of 10

Padlock Display

PART#	CONTENTS
00225	Padlock Display Board (24" x 24")
00225K	Padlock Merchandiser. Includes 00225 display board, 16 pegs (80004) and product listed below:

PART#	DESCRIPTION	QTY.
2251525	Brass Padlock 25x14mm - KD	4 ea.
2251526	Brass Padlock 25x14mm - KA	4 ea.
2251530	Brass Padlock 30x20mm - KD	4ea.
2251531	Brass Padlock 30x20mm - KA	4 ea.
2251540	Brass Padlock 40x23mm - KD	4 ea.
2251541	Brass Padlock 40x23mm - KA	4 ea.
2251550	Brass Padlock 50x30mm - KD	4 ea.
2251551	Brass Padlock 50x30mm - KA	4 ea.
2251560	Brass Padlock 60x33mm - KD	4 ea.
2251561	Brass Padlock 60x33mm - KA	4 ea.
2251740	Brass Padlock 40x63mm - KD	4 ea.
2251840	Brass Padlock 40x100mm - KD	4 ea.
2251850	Brass Padlock 50x75mm - KD	4 ea.
2253540	Waterproof Padlock 40mm - KD	4 ea.
2253541	Waterproof Padlock 40mm - KD	4 ea.
2253554	Combination Padlock 50mm	1 ea.
00225	Padlock Board Only	1 ea.

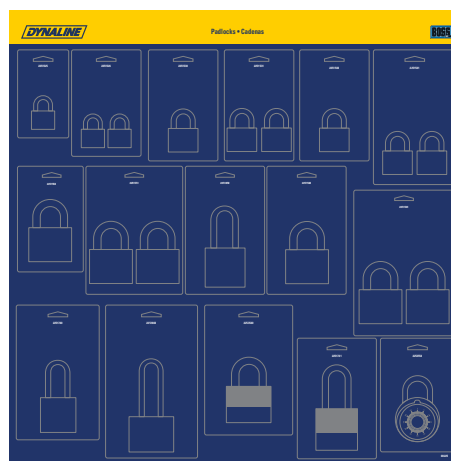

KD = Keyed different
KA = Keyed alike

Snaps

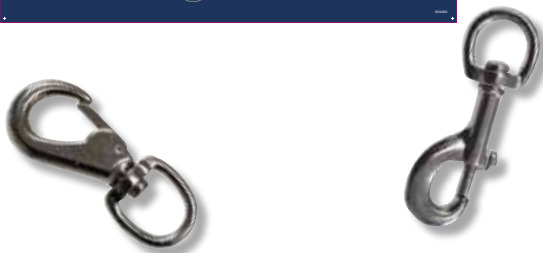
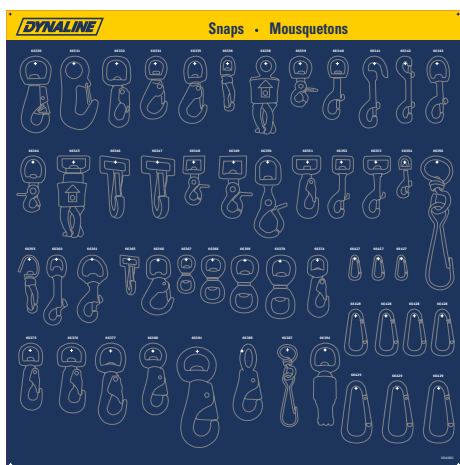

PART#	DESCRIPTION	QUANTITY
66330	Bull Snap, 1"	1 pkg. of 5
66331	Solid Snap Hook, 11/16"	1 pkg. of 5
66332	Cap Snap, 1"	1 pkg. of 5
66334	Swivel Eye Snap, 11/16"	1 pkg. of 5
66335	Swivel Eye Snap, 13/16"	1 pkg. of 5
66336	Dog Lead Snap, 3/8"	1 pkg. of 5
66338	Panic Snap, 1/2"	1 pkg. of 5
66339	Trigger Snap, 5/8"	1 pkg. of 5
66340	Bolt Snap, 11/16"	1 pkg. of 5
66341	Open Eye Snap, 13/16"	1 pkg. of 5
66342	Double Bolt Snap, 7/16"	1 pkg. of 5
66343	Bolt Snap, 3/4"	1 pkg. of 5
66344	Trigger Snap, 3/4"	1 pkg. of 5
66346	Loop Snap, 3/4"	1 pkg. of 5
66347	Loop Snap, 1"	1 pkg. of 5

PART#	CONTENTS	
00448	Snaps Display Board (24" x 24")	
00448K	Snaps Merchandiser. Includes 00448 display board, 52 pegs (80004) and product listed below:	
PART#	DESCRIPTION	QUANTITY
66348	Square Trigger Snap, 3/4"	1 pkg. of 5
66349	Trigger Snap, 1"	1 pkg. of 5
66350	Trigger Snap, 13/16"	1 pkg. of 5
66351	Spring Snap, 1"	1 pkg. of 5
66352	Swivel Loop Snap, 3/4"	1 pkg. of 5
66353	Swivel Loop Snap, 1"	1 pkg. of 5
66354	Mini Bolt Snap, 7/16"	1 pkg. of 5
66355	Open Decoy Snap, 1/2"	1 pkg. of 5
66356	Simplex Snap, 11/16"	1 pkg. of 5
66360	Solid Brass Bolt Snap, 1/2" x 3"	1 pkg. of 5
66361	Brass Bolt Snap, 1"	1 pkg. of 5
66365	Baby Square Eye Snap, 5/8"	1 pkg. of 5
66366	Bolt Snap, 3-1/4"	1 pkg. of 5
66367	1/2" Zinc Swivel Snap	1 pkg. of 5
66368	5/8" Zinc Swivel Snap	1 pkg. of 5
66369	3/4" Zinc Swivel Snap	1 pkg. of 5
66370	1" Zinc Swivel Snap	1 pkg. of 5
66374	5/8" Lever Snap, Nickel Plated	1 pkg. of 5
66375	3/4" Lever Snap, Nickel Plated	1 pkg. of 5
66376	1" Lever Snap, Nickel Plated	1 pkg. of 5
66377	Lever Snap, 1-1/8"	1 pkg. of 5
66380	Security Snap, 7/8"	1 pkg. of 5
66381	Security Snap Hook, 7/8"	1 pkg. of 5
66385	Eye Bull Snap, 3/4" x 3-3/4"	1 pkg. of 5
66387	Simplex Spring Snap, Swivel	1 pkg. of 5
66392	Bronze Animal Snap 1" x 4-1/2"	1 pkg. of 5
66394	Security Snap Swivel 1" x 4-1/8"	1 pkg. of 5
66427	Aluminium Snap Hook, 3/16"	1 pkg. of 10
66428	Aluminium Snap Hook, 1/4"	1 pkg. of 10
66429	Aluminium Snap Hook, 5/16"	1 pkg. of 10

Eyebolts & Rings

PART#

CONTENTS

00611 Eyebolts & Rings Display Board (24" x 24")

00611K **Eyebolts & Rings Merchandiser.**
Includes 00611 display board and 47 pegs (80004)

PART#	DESCRIPTION	QTY.
65102	Eyebolt, 3/8"	1 pkg. of 10
65104	Eyebolt, 3/8"	1 pkg. of 10
65106	Eyebolt, 9/16"	1 pkg. of 10
65107	Eyebolt, 9/16"	1 pkg. of 10
65108	Eyebolt, 9/16"	1 pkg. of 10
65109	Eyebolt, 9/16"	1 pkg. of 10
65110	Eyebolt, 9/16"	1 pkg. of 10
65111	Eyebolt, 9/16"	1 pkg. of 10
65112	Eyebolt, 3/4"	1 pkg. of 10
65113	Eyebolt, 3/4"	1 pkg. of 10
65114	Eyebolt, 3/4"	1 pkg. of 10
65115	Eyebolt, 3/4"	1 pkg. of 10
65117	Eyebolt, 1"	1 pkg. of 10
65118	Eyebolt, 1"	1 pkg. of 10
65119	Eyebolt, 1"	1 pkg. of 10
65120	Eyebolt, 1"	1 pkg. of 10
65123	Eyebolt, 1-1/4"	1 pkg. of 10
65124	Eyebolt, 1-1/4"	1 pkg. of 10
65161	Lag screw, 1/2"	1 pkg. of 10
65162	Lag screw, 1/2"	1 pkg. of 10
65163	Lag screw, 5/8"	1 pkg. of 10
65164	Lag screw, 5/8"	1 pkg. of 10
65165	Lagscrew, 3/4"	1 pkg. of 10
65166	Lagscrew, 3/4"	1 pkg. of 10
65172	Mounting Ring, 2"	1 pkg. of 10
65177	Mounting Ring Lag Screw, 2"	1 pkg. of 10
65178	Mounting Ring with Plate, 2"	1 pkg. of 10
66100	Shoulder Eyebolt, 1/2"	2 ea.
66101	Shoulder Eyebolt, 5/8"	2 ea.
66102	Shoulder Eyebolt, 3/4"	2 ea.



PART#	DESCRIPTION	QTY.
Part#	Description	Qty.
66103	Shoulder Eyebolt, 1"	2 ea.
66104	Shoulder Eyebolt, 1-1/4"	2 ea.
66105	Shoulder Eyebolt, 1/2"	2 ea.
66106	Shoulder Eyebolt, 5/8"	2 ea.
66107	Shoulder Eyebolt, 3/4"	2 ea.
66108	Shoulder Eyebolt, 1"	2 ea.
66173	D-Ring, 7/8"	1 pkg. of 10
66174	D-Ring, 7/8"	1 pkg. of 10
66175	D-Ring, 1"	1 pkg. of 10
66176	D-Ring, 1-1/8"	1 pkg. of 10
66178	D-Ring, 1-3/4"	1 pkg. of 10
66180	Split Key Ring, 3/4"	1 pkg. of 10
66182	Split Key Ring, 1"	1 pkg. of 10
66184	Split Key Ring, 1-1/4"	1 pkg. of 10
66410	Welded Ring, 1"	1 pkg. of 10
66411	Welded Ring, 1-1/8"	1 pkg. of 10
66412	Welded Ring, 2"	1 pkg. of 10

U-Bolts

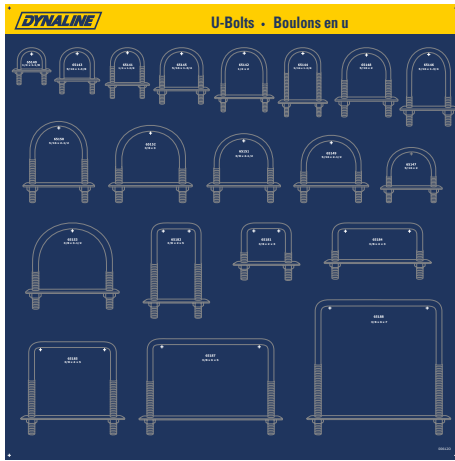

PART#	CONTENTS
00612	U-Bolts Display Board (24" x 24")
00612K	U-Bolts Merchandiser. Includes 00612 display board & 26 pegs (80004)

PART#	DESCRIPTION	QTY.
65140	1/4" x 1-1/8"	1 pkg. of 10
65141	1/4" x 1-3/8"	1 pkg. of 10
65142	1/4" x 2"	1 pkg. of 10
65143	5/16" x 1-3/8"	1 pkg. of 10
65144	5/16" x 1-3/8"	1 pkg. of 10
65145	5/16" x 1-3/4"	1 pkg. of 10
65146	5/16" x 1-3/4"	1 pkg. of 10
65147	5/16" x 2"	1 pkg. of 10
65148	5/16" x 2"	1 pkg. of 10
65149	5/16" x 2-1/2"	1 pkg. of 10
65150	5/16" x 2-1/2"	1 pkg. of 10
65151	3/8" x 2-1/2"	1 pkg. of 10
65152	3/8" x 3"	1 pkg. of 10
65153	Square, 3-1/2" x 4-5/8"	1 pkg. of 10
65181	Square, 2" x 3"	1 pkg. of 5
65182	Square, 2" x 5"	1 pkg. of 5
65184	Square, 4" x 3"	1 pkg. of 5
65185	Square, 4" x 5"	1 pkg. of 5
65187	Square, 6" x 5"	1 pkg. of 5
65188	Square, 6" x 7"	1 pkg. of 5

Weather Caps

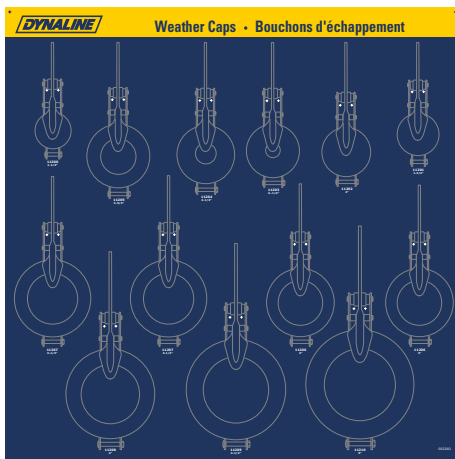

PART#	CONTENTS
00226	Weather Caps Display Board (24" x 24")
00226K	Weather Caps Merchandiser. Includes 00226 display board and 26 pegs (80004)

PART#	DESCRIPTION	QTY.
11200	1-1/2"	2 ea.
11201	1-3/4"	2 ea.
11202	2"	2 ea.
11203	2-1/4"	2 ea.
11204	2-1/2"	2 ea.
11205	2-3/4"	2 ea.
11206	3"	2 ea.
11207	3-1/2"	2 ea.
11208	4"	1 ea.
11209	4-1/2"	1 ea.
11210	5"	1 ea.

Pulley Blocks

PART# CONTENTS

00334 Pulley Blocks Display Board (24" x 24")

00334K **Pulley Blocks Merchandiser.**
Includes 00334 display board and 34 pegs (80004)

PART#	DESCRIPTION	QTY.
55800	Pulley, Swivel Steel, 1-1/2"	2 ea.
55801	Pulley, Swivel Steel, 2"	2 ea.
55802	Pulley, Swivel Steel, 2-1/2"	2 ea.
55803	Pulley, Swivel Steel, 3"	2 ea.
55810	Pulley, Fixed Steel, 1-1/2"	2 ea.
55811	Pulley, Fixed Steel, 2"	2 ea.
55812	Pulley, Fixed Steel, 2-1/2"	2 ea.
55813	Pulley, Fixed Steel, 3"	2 ea.
55840	Sheave 1-1/2", 420 lb	2 ea.
55841	Sheave 2", 480 lb	2 ea.
55842	Sheave 2-1/2", 550 lb	2 ea.
55843	Sheave 3", 650 lb	2 ea.
55870	Double Hook Swivel, 1-1/2"	2 ea.
55871	Double Hook Swivel, 2"	2 ea.
55872	Double Hook Swivel, 2-1/2"	2 ea.
55873	Double Hook Swivel, 3"	2 ea.
55900	Pulley, Sngl. Fixed, 3/4"	2 ea.
55901	Pulley, Sngl. Fixed, 1"	2 ea.
55902	Pulley, Sngl. Fixed, 1-1/4"	2 ea.
55903	Pulley, Sngl. Fixed, 1-1/2"	2 ea.
55904	Pulley, Sngl. Fixed, 2"	2 ea.



PART#	DESCRIPTION	QTY.
55906	Pulley, Dbl. Fixed, 3/4"	2 ea.
55907	Pulley, Dbl. Fixed, 1"	2 ea.
55908	Pulley, Dbl. Fixed, 1-1/2"	2 ea.
55909	Pulley, Dbl. Fixed, 2"	2 ea.
55915	Pulley, Sngl. Swivel, 3/4"	2 ea.
55916	Pulley, Sngl. Swivel, 1"	2 ea.
55917	Pulley, Sngl. Swivel, 1-1/4"	2 ea.
55918	Pulley, Sngl. Swivel, 1-1/2"	2 ea.
55919	Pulley, Sngl. Swivel, 2"	2 ea.
55925	Pulley, Dbl. Swivel, 3/4"	2 ea.
55926	Pulley, Dbl. Swivel, 1"	2 ea.
55927	Pulley, Dbl. Swivel, 1-1/4"	2 ea.
55928	Pulley, Dbl. Swivel, 1-1/2"	2 ea.

Aluminum Pulleys

PART# CONTENTS

00335 Aluminum Pulley Display Boards (two, 24" x 24")

00335K **Aluminum Pulleys Merchandiser.**
Includes two 00335 display boards and 36 pegs (80004)

PART#	DESCRIPTION	QTY.	PART#	DESCRIPTION	QTY.
55400	1-1/2" x 1/2"	1 ea.	55415	3-1/2" x 5/8"	2 ea.
55401	1-1/2" x 5/8"	2 ea.	55416	3-1/2" x 3/4"	1 ea.
55402	2" x 1/2"	1 ea.	55417	4" x 1/2"	1 ea.
55403	2" x 5/8"	2 ea.	55418	4" x 5/8"	2 ea.
55404	2" x 3/4"	1 ea.	55419	4" x 3/4"	1 ea.
55405	2-1/4" x 1/2"	1 ea.	55420	4-1/2" x 1/2"	1 ea.
55406	2-1/4" x 5/8"	2 ea.	55421	4-1/2" x 5/8"	2 ea.
55407	2-1/4" x 3/4"	1 ea.	55422	4-1/2" x 3/4"	1 ea.
55408	2-1/2" x 1/2"	1 ea.	55423	5" x 1/2"	1 ea.
55409	2-1/2" x 5/8"	2 ea.	55424	5" x 5/8"	1 ea.
55410	2-1/2" x 3/4"	1 ea.	55425	5" x 3/4"	1 ea.
55411	3" x 1/2"	1 ea.	55426	6" x 1/2"	1 ea.
55412	3" x 5/8"	2 ea.	55427	6" x 5/8"	1 ea.
55413	3" x 3/4"	1 ea.	55428	6" x 3/4"	1 ea.
55414	3-1/2" x 1/2"	1 ea.	55429	7" x 1/2"	1 ea.

DYNALINE Die Cast Aluminum Pulleys - Poulies en aluminium moulé

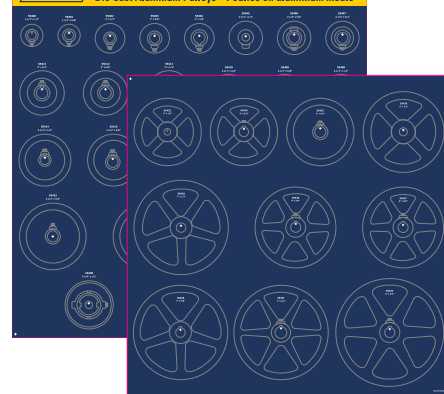

PART#	DESCRIPTION	QTY.
55430	7" x 5/8"	1 ea.
55431	7" x 3/4"	1 ea.
55434	8" x 3/4"	1 ea.
VARIABLE SPEED PULLEYS:		
55490	3-1/4" x 1/2"	1 ea.
55491	3-1/4" x 5/8"	1 ea.
55492	3-1/4" x 3/4"	1 ea.

Pins

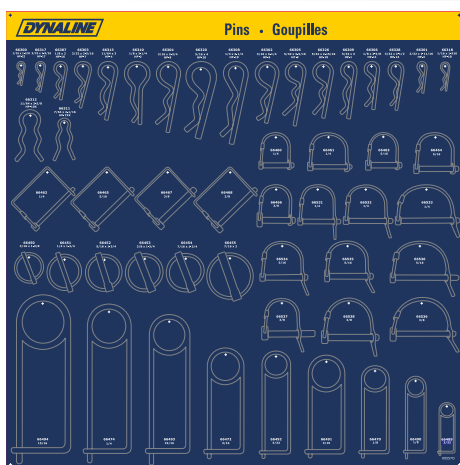

PART#	DESCRIPTION	QTY.
66300	Hair Pin, HP-22	1 pkg. of 25
66301	Hair Pin, HP-3	1 pkg. of 25
66302	Hair Pin, HP-6	1 pkg. of 25
66303	Hair Pin, HP-7	1 pkg. of 25
66304	Hair Pin, HP-8	1 pkg. of 25
66305	Hair Pin, HP-9	1 pkg. of 25
66306	Hair Pin, HP-11	1 pkg. of 25
66307	Hair Pin, HP-16	1 pkg. of 25
66308	Hair Pin, HP-19	1 pkg. of 10
66309	Hair Pin, HP-1	1 pkg. of 25
66310	Hair Pin, HP-2	1 pkg. of 25
66311	Hair Pin, HP-7XX	1 pkg. of 25
66312	Hair Pin, HP-10X	1 pkg. of 25
66313	Hair Pin, HP-4	1 pkg. of 25
66317	Hair Pin, HP-17	1 pkg. of 25
66318	Hair Pin, HP-18	1 pkg. of 25
66320	Hair Pin, HP-20	1 pkg. of 10
66325	Hair Pin, HP-25	1 pkg. of 25
66326	Hair Pin, HP-10	1 pkg. of 25
66328	Hair Pin, HP-14	1 pkg. of 25
66450	Linch Pin, 3/16"	1 pkg. of 10
66451	Linch Pin, 1/4"	1 pkg. of 10

PART#	CONTENTS
00557	Pins Display Board (24" x 24")
00557K	Pins Merchandiser. Includes 00557 display board and 53 pegs (80004)

PART#	DESCRIPTION	QTY.
66452	Linch Pin, 5/16"	1 pkg. of 10
66453	Linch Pin, 3/8"	1 pkg. of 10
66454	Linch Pin, 7/16"	1 pkg. of 10
66455	Linch Pin, 7/16"	1 pkg. of 10
66460	Quick Pin, 1-3/8"	1 pkg. of 5
66461	Quick Pin, 1-3/4"	1 pkg. of 5
66462	Quick Pin, 2-1/2"	1 pkg. of 5
66463	Quick Pin, 1-3/8"	1 pkg. of 5
66464	Quick Pin, 1-3/4"	1 pkg. of 5
66465	Quick Pin, 2-1/2"	1 pkg. of 5
66466	Quick Pin, 1-3/8"	1 pkg. of 5
66467	Quick Pin, 2-1/4"	1 pkg. of 5
66468	Quick Pin, 2-1/2"	1 pkg. of 5
66470	Safety Pin, 3-1/8"	1 pkg. of 10
66472	Safety Pin, 3-3/8"	1 pkg. of 5
66474	Safety Pin, 5-1/4"	1 pkg. of 5
66489	Safety Pin, 1-11/16"	1 pkg. of 10
66490	Safety Pin, 2-13/16"	1 pkg. of 10
66491	Safety Pin, 3"	1 pkg. of 5
66492	Safety Pin, 3-3/4"	1 pkg. of 5
66493	Safety Pin, 5"	1 pkg. of 5
66494	Safety Pin, 5"	1 pkg. of 5
66531	Tab, 1/4" x 1-5/8"	1 pkg. of 5
66532	Tab, 1/4" x 2"	1 pkg. of 5
66533	Tab, 1/4" x 2-3/4"	1 pkg. of 5
66534	Tab, 5/16" x 1-5/8"	1 pkg. of 5
66535	Tab, 5/16" x 2"	1 pkg. of 5
66536	Tab, 5/16" x 2-3/4"	1 pkg. of 5
66537	Tab, 3/8" x 1-5/8"	1 pkg. of 5
66538	Tab, 3/8" x 2-1/2"	1 pkg. of 5
66539	Tab, 3/8" x 2-3/4"	1 pkg. of 5



Tractor Linkage Parts - 12' x 24"

PART#	CONTENTS
00438	Tractor Linkage Display Board (12" x 24")
00438K	Tractor Linkage Parts Merchandiser. Includes 00438 display board and 26 pegs (80004)

PART#	DESCRIPTION	CAT.	QTY.
66560	Top Link Pin, 3/4"	1	2 ea.
66561	Top Link Pin, 3/4"	1	2 ea.
66562	Top Link Pin, 1"	2	2 ea.
66565	Top Link Pin, 1"	2	2 ea.
66580	Lift Arm Pin, 7/8"	1	2 ea.
66581	Lift Arm Pin, 7/8"	1	2 ea.
66582	Lift Arm Pin, 7/8"	1	2 ea.
66583	Lift Arm Pin, 1-1/8"	1-2	2 ea.
66585	Lift Arm Pin, 1-1/8"	1-2	2 ea.
66587	Lift Arm Pin, 7/8"	2-1	2 ea.
66588	Lift Arm Pin, 1-1/8"	2	2 ea.
66590	Lift Arm Pin, 7/8"	1	2 ea.
66602	Top Link Bushing, 3/4"	1-2 Long	2 ea.



PART#	DESCRIPTION	CAT.	QTY.
66604	Top Link Bushing, 1"	2-3	2 ea.
66608	Lift Arm Bushing, 7/8"	1-2	2 ea.
66610	Lift Arm Bushing, 1-1/8"	2-3	2 ea.
66612	Lift Arm Bushing, 1-1/8"	2-3 Long	2 ea.

Tractor linkage parts - 24" X 24"

PART#	CONTENTS
00440	Tractor Linkage Display Board (24" x 24")
00440K	Tractor Linkage Parts Merchandiser. Includes 00440 display board and 40 pegs (80004)

PART#	DESCRIPTION	CAT.	QTY.
66560	Top Link Pin	1	2 ea.
66561	Top Link Pin	1	2 ea.
66562	Top Link Pin	2	2 ea.
66563	Top Link Pin	1	2 ea.
66565	Top Link Pin	2	2 ea.
66566	Top Link Pin	3	2 ea.
66567	Top Link Pin	0	2 ea.
66580	Lift Arm Pin, 7/8"	1	2 ea.
66581	Lift Arm Pin, 7/8"	1	2 ea.
66582	Lift Arm Pin, 7/8"	1	2 ea.
66583	Lift Arm Pin, 1-1/8"	1-2	2 ea.
66584	Lift Arm Pin, 1-7/8"	2-3	2 ea.
66585	Lift Arm Pin, 1-1/8"	1-2	2 ea.
66586	Lift Arm Pin, 1-1/16"	1-2	2 ea.
66587	Lift Arm Pin, 7/8"	1-2	2 ea.
66588	Lift Arm Pin, 1-1/8"	2	2 ea.
66589	Lift Arm Pin, 1-1/8"	2	2 ea.
66590	Lift Arm Pin, 7/8"	1	2 ea.
66591	Lift Arm Pin, 5/8"	0	2 ea.
66592	Lift Arm Pin, 1-1/8"	1-2	2 ea.
66602	Top Link Bushing, 3/4"	1-2 Long	2 ea.
66603	Lift Arm Bushing, 1-1/8"	2-3	2 ea.

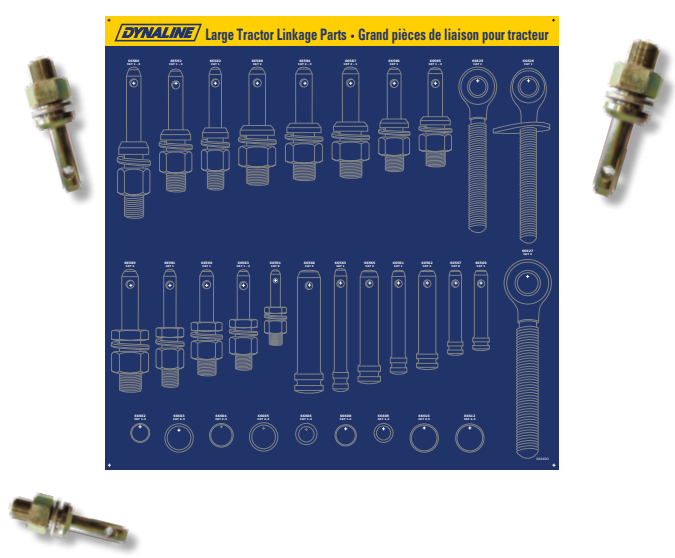

PART#	DESCRIPTION	CAT.	QTY.
66604	Top Link Bushing, 1"	2-3	2 ea.
66605	Lift Arm Bushing, 1-1/8"	2-3	2 ea.
66606	Lift Arm Bushing, 7/8"	1-2	2 ea.
66608	Lift Arm Bushing, 7/8"	1-2	2 ea.
66609	Lift Arm Bushing, 3/4"	1-2	2 ea.
66610	Lift Arm Bushing, 1-1/8"	2-3	2 ea.
66612	Lift Arm Bushing, 1-1/8"	2-3 Long	2 ea.
66625	Top Link End, 3/4"	1	2 ea.
66626	Top Link End, 3/4"	1	2 ea.
66627	Top Link End, 1"	2	2 ea.
66628	Top Link End, 1"	2	2 ea.

Farm packs

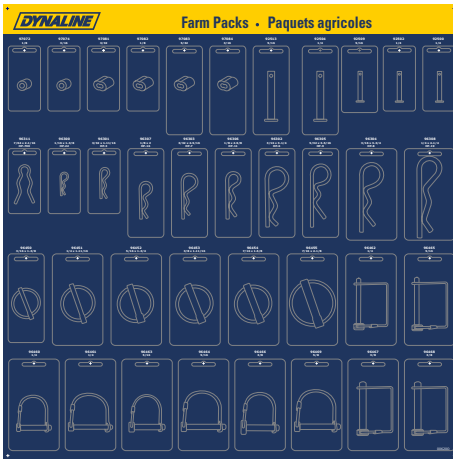

PART#	DESCRIPTION	QTY.
96462	Quick Pin Dynapak, 2-1/2"	4 pkgs.
96463	Quick Pin Dynapak, 1-3/8"	4 pkgs.
96464	Quick Pin Dynapak, 1-3/4"	4 pkgs.
96465	Quick Pin Dynapak, 2-1/2"	4 pkgs.
96466	Quick Pin Dynapak, 1-3/8"	4 pkgs.
96467	Quick Pin Dynapak, 2-1/4"	4 pkgs.
96468	Quick Pin Dynapak, 2-1/2"	4 pkgs.
96469	Quick Pin Dynapak, 3-1/8"	4 pkgs.
97072	Cable Stop Dynapak	4 pkgs.
97074	Cable Stop Dynapak	4 pkgs.
97081	Ferrule Dynapak	4 pkgs.
97082	Ferrule Dynapak	4 pkgs.
97083	Ferrule Dynapak	4 pkgs.
97084	Ferrule Dynapak	4 pkgs.

PART#	CONTENTS	
00620	Farm Packs Display Board (24" x 24")	
00620K	Farm Packs Merchandiser. Includes 00620 display board and 37 pegs (80004)	
PART#	DESCRIPTION	QTY.
92500	Clevis Pin Dynapak	4 pkgs.
92502	Clevis Pin Dynapak	4 pkgs.
92504	Clevis Pin Dynapak	4 pkgs.
92509	Clevis Pin Dynapak	4 pkgs.
92513	Clevis Pin Dynapak	4 pkgs.
96300	Hair Pin Dynapak, 1/4"	4 pkgs.
96301	Hair Pin Dynapak, 7/16"	4 pkgs.
96302	Hair Pin Dynapak, 7/8"	4 pkgs.
96303	Hair Pin Dynapak, 5/8"	4 pkgs.
96304	Hair Pin Dynapak, 7/8"	4 pkgs.
96305	Hair Pin Dynapak, 3/4"	4 pkgs.
96306	Hair Pin Dynapak, 9/16"	4 pkgs.
96307	Hair Pin Dynapak, 1/2"	4 pkgs.
96308	Hair Pin Dynapak, 3/4"	4 pkgs.
96311	Hair Pin Dynapak, 7/16"	4 pkgs.
96450	Linch Pin Dynapak, 3/16"	4 pkgs.
96451	Linch Pin Dynapak, 1/4"	4pkgs.
96452	Linch Pin Dynapak, 5/16"	4 pkgs.
96453	Linch Pin Dynapak, 3/8"	4 pkgs.
96454	Linch Pin Dynapak, 7/16"	4 pkgs.
96455	Linch Pin Dynapak, 7/16"	4 pkgs.
96460	Quick Pin Dynapak, 1-3/8"	4 pkgs.
96461	Quick Pin Dynapak, 1-3/4"	4 pkgs.

Muffler Clamps

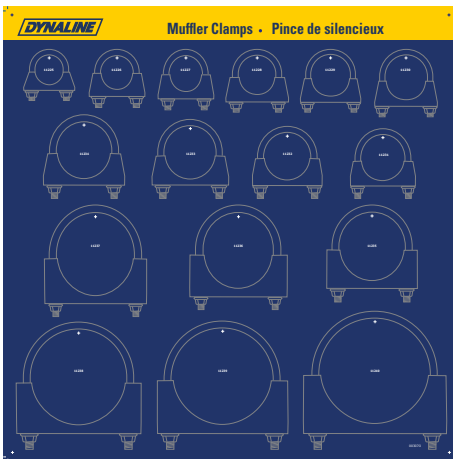

PART#	CONTENTS				
00307	Muffler Clamps Display Board (24" x 24")				
00307K	Muffler Clamps Merchandiser. Includes 00307 display board and 16 pegs (80004)				
PART#	DESCRIPTION	QTY.	PART#	DESCRIPTION	QTY.
11225	Muffler Clamp 1-1/2"	2	11233	Muffler Clamp 2-3/4"	2
11226	Muffler Clamp 1-5/8"	2	11234	Muffler Clamp 3"	2
11227	Muffler Clamp 1-3/4"	2	11235	Muffler Clamp 3-1/2"	2
11228	Muffler Clamp 1-7/8"	2	11236	Muffler Clamp 4"	2
11229	Muffler Clamp 2"	2	11237	Muffler Clamp 4-1/2"	2
11230	Muffler Clamp 2-1/8"	2	11238	Muffler Clamp 5"	2
11231	Muffler Clamp 2-1/4"	2	11239	Muffler Clamp 5-1/2"	2
11232	Muffler Clamp 2-1/2"	2	11240	Muffler Clamp 6"	2

Hitch Pins (Fold Over Handle with Chain)

PART#	CONTENTS	
00436	Hitch Pins (FOH) Display Board (24" x 24")	
00436K	"Fold Over Handle" Hitch Pins Merchandiser. Includes 00436 display board and 9 pegs (80004)	
PART#	DESCRIPTION	QTY.
66280	1/2" x 4-1/4"	2 ea.
66281	5/8" x 4-1/4"	2 ea.
66282	5/8" x 6-1/4"	2 ea.
66283	3/4" x 4-1/4"	2 ea.
66284	3/4" x 6-1/4"	2 ea.
66285	7/8" x 6-1/4"	2 ea.
66286	1" x 6-1/4"	2 ea.
66287	1-1/8" x 6-1/4"	2 ea.
66288	1-1/4" x 6-1/4"	2 ea.

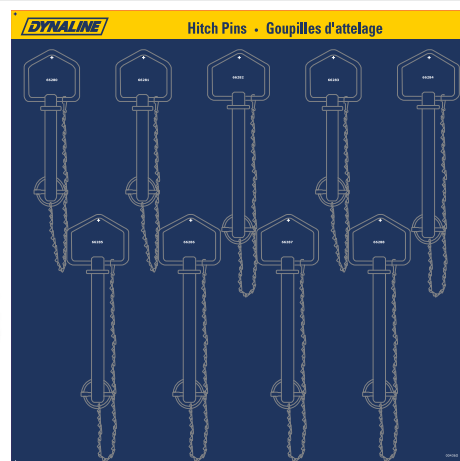

Grade 8 Hitch Pins

PART#	CONTENTS	
00439	Grade 8 Hitch Pins Display Board (24" x 24")	
00439K	Grade 8 Hitch Pins Merchandiser. Includes 00439 display board and 22 pegs (80004)	
PART#	DESCRIPTION	QTY.
66860	1/2" x 3-5/8"	2 ea.
66861	5/8" x 4"	2 ea.
66862	5/8" x 6"	2 ea.
66863	3/4" x 4"	2 ea.
66864	3/4" x 6-1/2"	2 ea.
66865	7/8" x 4-1/4"	2 ea.
66866	7/8" x 6-1/2"	2 ea.
66867	1" x 4-3/4"	2 ea.
66868	1" x 7"	2 ea.
66869	1-1/8" x 7"	2 ea.
66870	1-1/4" x 7"	1 ea.

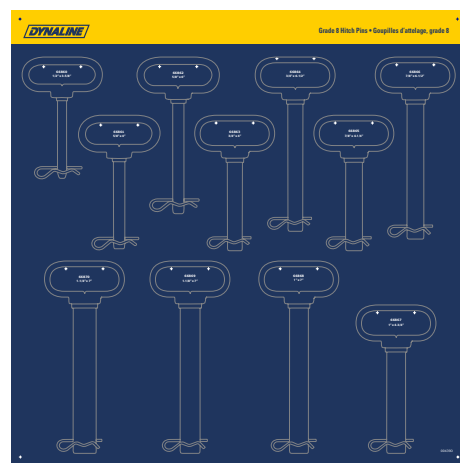

E-Grip & Forged Steel Hitch Pins

PART#	CONTENTS	
00441	E-Grip & Forged Steel Hitch Pins Display Board (24" x 24")	
00441K	E-Grip & Forged Steel Hitch Pins Merchandiser. Includes 00441 display board and 22 pegs (80004)	
PART#	DESCRIPTION	QTY.
66872	1/2" x 3-1/2"	2 ea.
66873	5/8" x 3-3/4"	2 ea.
66874	3/4" x 4"	2 ea.
66875	5/8" x 6"	2 ea.
66876	3/4" x 6-1/4"	2 ea.
66877	7/8" x 6-1/2"	2 ea.
66878	1" x 6-3/4"	2 ea.
66882	1-1/8" x 7"	1 ea.
66883	1-1/4" x 7"	1 ea.

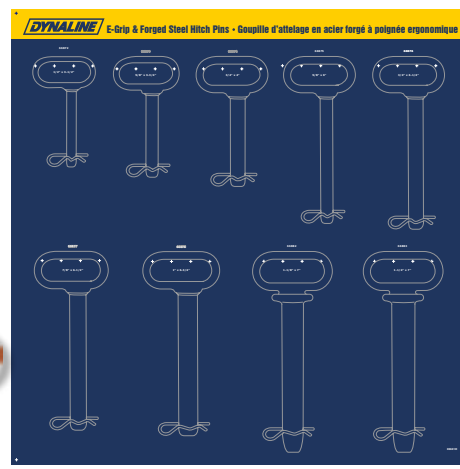

Hitch Pins

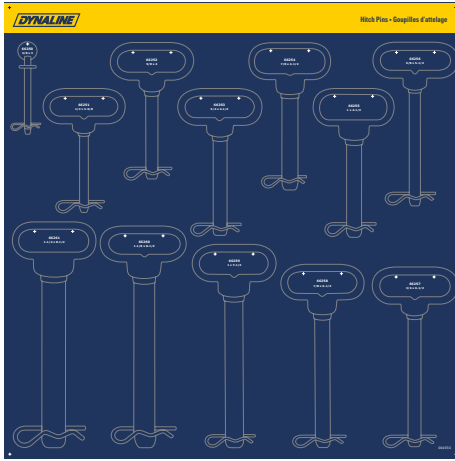

PART#

CONTENTS

00435

Hitch Pins Display Board (24" x 24")

00435K

Hitch Pins Merchandiser.
Includes 00435 display board and 23 pegs (80004)



PART#	DESCRIPTION	QTY.
66250	3/8" x 3"	2 ea.
66251	1/2" x 3-5/8"	2 ea.
66252	5/8" x 4"	2 ea.
66253	3/4" x 4-1/2"	2 ea.
66254	7/8" x 4-1/2"	2 ea.
66255	1" x 4-1/2"	2 ea.
66256	5/8" x 5-1/2"	2 ea.
66257	3/4" x 6-1/2"	2 ea.
66258	7/8" x 6-1/2"	2 ea.
66259	1" x 7-1/2"	2 ea.
66260	1-1/8" x 8-1/2"	1 ea.
66261	1-1/4" x 8-1/2"	1 ea.

Wire Rope Accessories

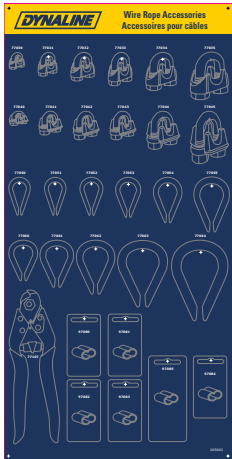

PART#

CONTENTS

00566

Wire Rope Accessories Display Board (12" x 24")

00566K

Wire Rope Accessories Merchandiser.
Includes 00566 display board and 30 pegs (80004)



PART#	DESCRIPTION	QTY.
77030	Malleable Clip, 1/8"	1 pkg. of 10
77031	Malleable Clip, 3/16"	1 pkg. of 10
77032	Malleable Clip, 1/4"	1 pkg. of 10
77033	Malleable Clip, 5/16"	1 pkg. of 10
77034	Malleable Clip, 3/8"	2 pkg. of 5
77035	Malleable Clip, 1/2"	2 pkg. of 5
77040	Forged Clip, 1/8"	1 pkg. of 5
77041	Forged Clip, 3/16"	1 pkg. of 5
77042	Forged Clip, 1/4"	1 pkg. of 5
77043	Forged Clip, 5/16"	1 pkg. of 5
77044	Forged Clip, 3/8"	1 pkg. of 5
77045	Forged Clip, 1/2"	1 pkg. of 5
77050	Thimble, 1/8"	1 pkg. of 10
77051	Thimble, 3/16"	1 pkg. of 10
77052	Thimble, 1/4"	1 pkg. of 10
77053	Thimble, 5/16"	1 pkg. of 10
77054	Thimble, 3/8"	1 pkg. of 10
77055	Thimble, 1/2"	1 pkg. of 5
77060	Thimble, 1/4" HD	1 pkg. of 10

PART#	DESCRIPTION	QTY.
77061	Thimble, 5/16" HD	1 pkg. of 10
77062	Thimble, 3/8" HD	1 pkg. of 10
77063	Thimble, 1/2" HD	1 pkg. of 5
77064	Thimble, 5/8" HD	10 ea.
77107	Mini Cable Clipper	1 ea.
97080	Cable Sleeve Dynapak	4 pkgs.
97081	Cable Sleeve Dynapak	4 pkgs.
97082	Cable Sleeve Dynapak	4 pkgs.
97083	Cable Sleeve Dynapak	2 pkgs.
97084	Cable Sleeve Dynapak	4 pkgs.
97085	Cable Sleeve Dynapak	2 pkgs.

Stainless Steel Hardware

PART# CONTENTS

00619 Chain Connectors Display Board (12" x 24")

00619K **Stainless Steel Merchandiser.**
Includes 00619 display board, 40 pegs (80004) and product listed below:

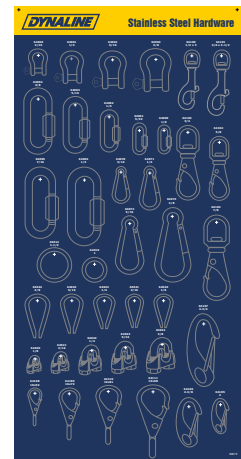

PART#	DESCRIPTION	QTY.
64000	Quick Link, 1/8"	1 pkg. 5
64001	Quick Link, 5/32"	1 pkg. 5
64002	Quick Link, 1/4"	1 pkg. 5
64003	Quick Link, 5/16"	1 pkg. 5
64004	Quick Link, 3/8"	1 pkg. 5
64020	Wire Rope Clip, 1/8"	1 pkg. 5
64021	Wire Rope Clip, 3/16"	1 pkg. 5
64022	Wire Rope Clip, 1/4"	1 pkg. 5
64023	Wire Rope Clip, 5/16"	1 pkg. 5
64024	Wire Rope Clip, 3/8"	1 pkg. 5
64040	Thimble, 1/8"	1 pkg. 5
64041	Thimble, 3/16"	1 pkg. 5
64042	Thimble, 1/4"	1 pkg. 5
64043	Thimble, 5/16"	1 pkg. 5

PART#	DESCRIPTION	QTY.
64044	Thimble, 3/8"	1 pkg. 5
64060	Shackle, 3/16"	1 pkg. 5
64061	Shackle, 1/4"	1 pkg. 5
64062	Shackle, 5/16"	1 pkg. 5
64063	Shackle, 3/8"	1 pkg. 5
64070	Snap Link, 3/16"	1 pkg. 5
64071	Snap Link, 1/4"	1 pkg. 5
64072	Snap Link, 5/16"	1 pkg. 5
64073	Snap Link, 3/8"	1 pkg. 5
64100	Bolt Snap, 1/2"	1 pkg. 5
64101	Bolt Snap, 3/4"	1 pkg. 5
64102	Security Snap, 5/8"	1 pkg. 5
64103	Security Snap, 3/4"	1 pkg. 5
64104	Security Snap, 7/8"	1 pkg. 5
64105	Spring Snap, 2"	1 pkg. 5

PART#	DESCRIPTION	QTY.
64106	Spring Snap, 2-3/8"	1 pkg. 5
64107	Spring Snap, 3-3/4"	1 pkg. 5
64108	Boat Snap, 10 x 53	1 pkg. 5
64109	Boat Snap, 16 x 72	1 pkg. 5
64110	Boat Snap, 19 x 81	1 pkg. 5
64111	Boat Snap, 19 x 98	1 pkg. 5

Chain Connectors

PART# CONTENTS

00614 Chain Connectors Display Board (12" x 24")

00614K **Chain Connectors Merchandiser.**
Includes 00614 display board, 35 pegs (80004) and product listed below:

PART#	DESCRIPTION	QUANTITY
66138	Mid Link, 1/4"	4 ea.
66139	Mid Link, 3/8"	4 ea.
66140	Mid Link, 1/2"	2 ea.
66165	Forged Chain Swivel, 1/4"	1 pkg. of 2
66166	Forged Chain Swivel, 5/16"	1 pkg. of 2
66167	Forged Chain Swivel, 3/8"	1 pkg. of 2
66168	Forged Chain Swivel, 1/2"	1 pkg. of 2
66400	Repair Link, 1/8"	1 pkg. of 10
66401	Repair Link, 3/16"	1 pkg. of 10
66402	Repair Link, 1/4"	1 pkg. of 10
66403	Repair Link, 5/16"	1 pkg. of 5
66404	Repair Link, 3/8"	1 pkg. of 5
66413	Link Lock, 1/4"	1 pkg. of 5
66414	Link Lock 5/16"	1 pkg. of 5
66415	Link Lock, 3/8"	1 pkg. of 5
66416	Missing Link, 1/4"	1 pkg. of 5

PART#	DESCRIPTION	QUANTITY
66417	Missing Link, 5/16"	1 pkg. of 5
66418	Missing Link, 3/8"	1 pkg. of 5
66419	Snap Link, 5 mm	1 pkg. of 10
66420	Snap Link, 6 mm	1 pkg. of 10
66421	Snap Link, 8 mm	1 pkg. of 10
66422	Snap Link, 10 mm	1 pkg. of 10
66425	Snap Link, 11 mm	1 pkg. of 5
66426	Snap Link, 12 mm	1 pkg. of 5
66430	Quick Link, 1/8"	1 pkg. of 10
66431	Quick Link, 3/16"	1 pkg. of 10
66432	Quick Link, 1/4"	1 pkg. of 10
66433	Quick Link, 5/16"	1 pkg. of 5
66434	Quick Link, 3/8"	1 pkg. of 5
66435	Quick Link, 7/16"	1 pkg. of 5
66436	Quick Link, 1/2"	1 pkg. of 5
66440	Cold Shut, 3/16"	1 pkg. of 10
66441	Cold Shut, 1/4"	1 pkg. of 10
66442	Cold Shut, 5/16"	1 pkg. of 5
66443	Cold Shut, 3/8"	1 pkg. of 5

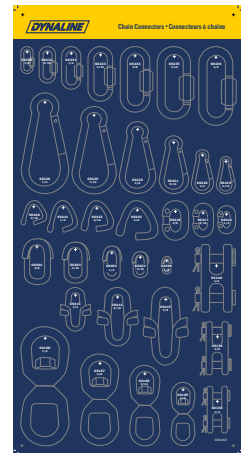

Wire Rope Accessories



PART#

CONTENTS

00567	Wire Rope Display Board (24" x 24")
00567K	Wire Rope Accessories Merchandiser. Includes 00567 display board and 41 pegs (80004)

PART#

DESCRIPTION

QTY.

77031	Malleable Clip, 3/16"	1 pkg. of 10
77032	Malleable Clip, 1/4"	1 pkg. of 10
77033	Malleable Clip, 5/16"	1 pkg. of 10
77034	Malleable Clip, 3/8"	1 pkg. of 5
77035	Malleable Clip, 1/2"	1 pkg. of 5
77036	Malleable Clip, 5/8"	2 ea.
77037	Malleable Clip, 3/4"	2 ea.
77038	Malleable Clip, 7/8"	2 ea.
77039	Malleable Clip, 1"	2 ea.
77041	Forged Clip, 3/16"	1 pkg. of 5
77042	Forged Clip, 1/4"	1 pkg. of 5
77043	Forged Clip, 5/16"	1 pkg. of 5
77044	Forged Clip, 3/8"	1 pkg. of 5
77045	Forged Clip, 1/2"	1 pkg. of 5
77046	Forged Clip, 5/8"	2 ea.
77047	Forged Clip, 3/4"	2 ea.
77048	Forged Clip, 7/8"	2 ea.
77049	Forged Clip, 1"	2 ea.
77050	Thimble, 1/8"	1 pkg. of 10
77051	Thimble, 3/16"	1 pkg. of 10
77052	Thimble, 1/4"	1 pkg. of 10
77053	Thimble, 5/16"	1 pkg. of 10
77054	Thimble, 3/8"	1 pkg. of 10
77055	Thimble, 1/2"	1 pkg. of 5
77056	Thimble, 5/8"	2 ea.
77060	Thimble, 1/4", H.D.	1 pkg. of 10
77061	Thimble, 5/16", H.D.	1 pkg. of 10
77062	Thimble, 3/8", H.D.	1 pkg. of 10
77063	Thimble, 1/2", H.D.	1 pkg. of 5
77064	Thimble, 5/8", H.D.	2 ea.
77066	Thimble, 7/8", H.D.	2 ea.
77067	Thimble, 1", H.D.	2 ea.
77068	Thimble, 1-1/8", H.D.	2 ea.
97080	Cable Sleeves Dynapak	1 pkg.
97081	Cable Sleeves Dynapak	1 pkg.
97082	Cable Sleeves Dynapak	1 pkg.
97083	Cable Sleeves Dynapak	1 pkg.
97084	Cable Sleeves Dynapak	1 pkg.
97085	Cable Sleeves Dynapak	1 pkg.

Does not include cable clipper

Chain Hooks

PART#	CONTENTS	
00408	Chain Hooks Display Board (24" x 24")	
	Chain Hooks Merchandiser.	
00408K	Includes 00408 display board, 30 pegs (80004) and product listed below:	
PART#	DESCRIPTION	QTY.
66070	Clevis Slip Hook, c/w latch, 1/4"	1 ea.
66071	Clevis Slip Hook, c/w latch, 5/16"	2 ea.
66072	Clevis Slip Hook, c/w latch, 3/8"	2 ea.
66073	Clevis Slip Hook, c/w latch, 1/4"	2 ea.
66074	Clevis Slip Hook, c/w latch, 5/16"	2 ea.
66075	Clevis Slip Hook, c/w latch, 3/8"	2 ea.
66080	Alloy Grab Hook, c/w latch, 1/4"	1 ea.
66081	Alloy Grab Hook, c/w latch, 5/16"	1 ea.
66082	Alloy Grab Hook, c/w latch, 3/8"	1 ea.
66110	Clevis Grab Hook, 1/4"	4 ea.
66111	Clevis Grab Hook, 5/16"	4 ea.
66112	Clevis Grab Hook, 3/8"	4 ea.
66115	Clevis Grab Hook, 1/4"	4 ea.
66116	Clevis Grab Hook, 5/16"	2 ea.
66117	Clevis Grab Hook, 3/8"	2 ea.
66120	Clevis Grab Hook, Alloy, 1/4"	4 ea.
66121	Clevis Grab Hook, Alloy, 5/16"	4 ea.
66122	Clevis Grab Hook, Alloy, 3/8"	4 ea.
66123	Eye Grab Hook, 1/4"	2 ea.



PART#	DESCRIPTION	QTY.
66124	Eye Grab Hook, 5/16"	1 ea.
66125	Eye Grab Hook, 3/8"	1 ea.
66129	Eye Grab Hook, 1/4"	1 ea.
66130	Eye Grab Hook, 5/16"	1 ea.
66131	Eye Grab Hook, 3/8"	1 ea.
66136	Safety Winch Hook, 1/4"	2 ea.
66137	Safety Lanyard Hook (single)	4 ea.
66137S	Safety Lanyard Hook (double)	2 ea.
66145	Eye Hoist Hook, 3/4T	2 ea.
66146	Eye Hoist Hook, 1T	2 ea.
66147	Eye Hoist Hook, 1.5T	1 ea.

Shackles & Clevises

PART#	CONTENTS	
00386	Shackles & Clevises Display Board (24" x 24")	
	Shackles & Clevises Merchandiser.	
00386K	Includes 00386 display board, 25 pegs (80004) and product listed below:	
PART#	DESCRIPTION	QTY.
66000	Anchor Shackle, 1/4"	2 ea.
66001	Anchor Shackle, 5/16"	2 ea.
66002	Anchor Shackle, 3/8"	2 ea.
66003	Anchor Shackle, 7/16"	2 ea.
66004	Anchor Shackle, 1/2"	2 ea.
66005	Anchor Shackle, 5/8"	1 ea.
66006	Anchor Shackle, 3/4"	1 ea.
66007	Anchor Shackle, 7/8"	1 ea.
66008	Anchor Shackle, 1"	1 ea.
66010	Anchor Shackle, 1/4"	2 ea.
66011	Anchor Shackle, 5/16"	2 ea.
66012	Anchor Shackle, 3/8"	2 ea.
66013	Anchor Shackle, 1/2"	2 ea.
66014	Anchor Shackle, 5/8"	1 ea.
66017	Anchor Shackle, 7/16"	1 ea.
66020	Chain Shackle, 1/4"	2 ea.

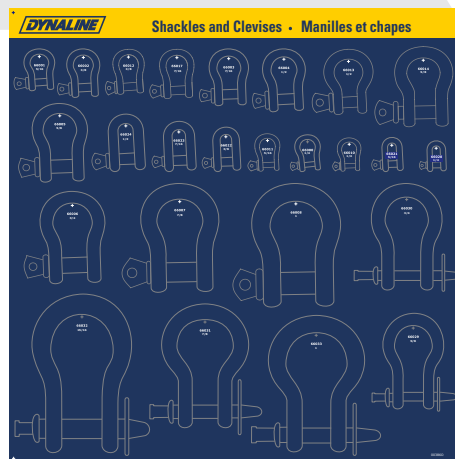

PART#	DESCRIPTION	QTY.
66021	Chain Shackle, 5/16"	2 ea.
66022	Chain Shackle, 3/8"	2 ea.
66023	Chain Shackle, 7/16"	2 ea.
66024	Chain Shackle, 1/2"	2 ea.
66029	Straight Clevis, 5/8"	1 ea.
66030	Straight Clevis, 3/4"	1 ea.
66031	Straight Clevis, 7/8"	1 ea.
66032	Straight Clevis, 15/16"	1 ea.
66033	Straight Clevis, 1"	1 ea.

Stroke Control

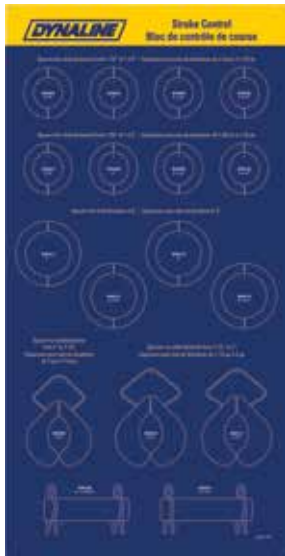

PART#	DESCRIPTION	QTY.
80004	Rod Rd - 1/4 x 6-1/2"	16
55003	Stroke Control 1-1/4 x 3/4	2 ea.

PART#	CONTENTS	
00297	Stroke Control Board (12" x 24")	
00297K	Stroke Control Merchandiser. Includes 00297 display board and 17 pegs (80004)	
PART#	DESCRIPTION	QTY.
55004	Stroke Control 1-1/4 x 1	2 ea.
55005	Stroke Control 1-1/4 x 1-1/4	2 ea.
55006	Stroke Control 1-1/4 x 1-1/2	2 ea.
55007	Stroke Control 1-1/2 x 3/4	2 ea.
55008	Stroke Control 1-1/2 x 1	2 ea.
55009	Stroke Control 1-1/2 x 1-1/4	2 ea.
55010	Stroke Control 1-1/2 x 1-1/2	2 ea.
55011	Stroke Control 2 x 1	2 ea.
55012	Stroke Control 2 x 1-1/2	2 ea.
55013	Stroke Control 2 x 2	2 ea.
55014	Stroke Control 2 x 4-1/4	2 ea.
56006	Stroke Control 1/2 *	2 ea.
56010	Stroke Control 3/8 *	2 ea.
56011	Stroke Control 1/2 *	2 ea.

Keystock



PART#	CONTENTS
00285	Keystock Bin only. 8 compartments, made of durable blue plastic. Dimensions: 10" x 9-1/8" x 1-1/2"
00255K	Square Keystock Merchandiser. Includes 00285 Keystock Bin.

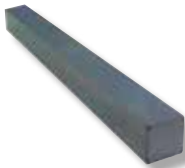

PART#	DESCRIPTION	QTY.	PART#	DESCRIPTION	QTY.
22750	1/8"	1 pkg. of 5	22753	5/16"	1 pkg. of 5
22751	3/16"	1 pkg. of 5	22754	3/8"	1 pkg. of 5
22752	1/4"	1 pkg. of 5	22755	7/16"	1 pkg. of 5



PART#	CONTENTS				
00265K	Rectangular Keystock Merchandiser. 36 pieces, 12" long / 8 part numbers. Includes 00285 Keystock Bin.				
PART#	DESCRIPTION	QTY.	PART#	DESCRIPTION	QTY.
22782	3/16" x 1/4"	1 pkg. of 5	22791	3/8" x 7/16"	1 pkg. of 5
22785	1/4" x 5/16"	1 pkg. of 5	22792	3/8" x 1/2"	1 pkg. of 5
22786	1/4" x 3/8"	1 pkg. of 5	22795	7/16" x 1/2"	1 pkg. of 5
22789	5/16" x 3/8"	1 pkg. of 5	22796	1/2" x 5/8"	1 pkg. of 2



PART#	CONTENTS				
00275K	Step Keystock Merchandiser. 16 pieces, 12" long / 8 part numbers Includes 00285 Keystock Bin				
PART#	DESCRIPTION	QTY.	PART#	DESCRIPTION	QTY.
22821	3/16" x 1/4"	1 pkg. of 2	22825	3/8" x 7/16"	1 pkg. of 2
22822	1/4" x 5/16"	1 pkg. of 2	22826	3/8" x 1/2"	1 pkg. of 2
22823	1/4" x 3/8"	1 pkg. of 2	22827	7/16" x 1/2"	1 pkg. of 2
22824	5/16" x 3/8"	1 pkg. of 2	22828	1/2" x 5/8"	1 pkg. of 2

For tolerance information, see the Shop Supplies Catalogue

Universal Display Boards

Create your own product selection. Simply position and drill the holes you need. Order 80004 pegs as required (sold separately). Two sizes available.

PART#	DESCRIPTION
00800	12" x 24"
00801	24" x 24"



00015 - Display Tags
2" x 3-1/2" Also Available



Caster Wheels Plan-O-Gram

PART#	CONTENTS
00300	Caster Wheels Backdrop (48" x 72")
00300K	Caster Wheels Plan-O-Gram. Includes 00300, and products listed below.

PART#	DESCRIPTION	QUANTITY
31050	Rigid top plate 5"	4 ea.
31060	Rigid top plate 6"	4 ea.
31080	Rigid top plate 8"	4 ea.
32015	Swivel wheel 1-1/2"	12 ea.
32020	Swivel wheel 2"	12 ea.
32025	Swivel wheel 2-1/2"	8 ea.
32030	Swivel wheel 3"	8 ea.
32040	Swivel wheel 4"	4 ea.
32050	Swivel wheel 5"	4 ea.
32060	Swivel wheel 6"	4 ea.
32080	Swivel wheel 8"	4 ea.
33015	Swivel with side locking brake 1-1/2"	12 ea.
33020	Swivel with side locking brake 2"	12 ea.
33025	Swivel with side locking brake 2-1/2"	8 ea.
33030	Swivel with side locking brake 3"	8 ea.
33040	Swivel with side locking brake 4"	4 ea.
33050	Swivel with side locking brake 5"	4 ea.
33060	Swivel with side locking brake 6"	4 ea.
33080	Swivel with side locking brake 8"	4 ea.
31100	Pneumatic Caster Wheel fixed 10"	2 ea.
31101	Pneumatic Caster Wheel with swivel 10"	2 ea.
31102	Flat Free Caster Wheel fixed 10"	2 ea.
31103	Flat Free Caster Swivel wheel 10"	2 ea.
HB2035	Storage Bin	6 ea.
HB2045	Storage Bin	6 ea.
HB3045	Storage Bin	12 ea.



(Gondola not included)

PART#	DESCRIPTION	QUANTITY
31015	Rigid top plate 1-1/2"	12 ea.
31020	Rigid top plate 2"	12 ea.
31025	Rigid top plate 2-1/2"	8 ea.
31030	Rigid top plate 3"	8 ea.
31040	Rigid top plate 4"	4 ea.

Lubrication Plan-O-Gram

PART#	CONTENTS	
01031	Lubrication Backdrop (48" x 48")	
01031K	Lubrication Plan-O-Gram. Includes 01031, 64 pegs (80004), and contents listed below.	
PART#	DESCRIPTION	QUANTITY
00163	S.A.E. Grease Fitting Dynakit, 40 Pcs.	2 ea.
00181	Metric Grease Fittings Dynakit, 50 Pcs.	2 ea.
00182	Drive-In Grease Fittings Dynakit, 50 Pcs.	2 ea.
11066	Professional Pistol Grease Gun	2 ea.
11073	Multi-Purpose Lithium Grease, 3 X 85G	1 Pkg. of 3
11076	Needle Nose Adapter, 4"	2 ea.
11077	Grease Gun Holder Bracket	2 ea.
11091	Lever Action Pail Pump	1 ea.
11122	Grease Injector, 18Ga	1 Pkg. of 3
11140	Grease Hose 12"	2 ea.
11141	Grease Hose 18"	2 ea.
13002	2 Tube Grease Holder	4 ea.
11071A	360° Swivel Coupler 1/8" Npt	2 ea.
11075A	Needle Nose Dispenser, 1-1/2"	2 ea.
11080A	Needle Nose Adapter, Fine	2 ea.
11081A	90° Angle Grease Coupler	2 ea.
11082C	Premium Lever Grease Gun, H.D.	2 ea.
11084A	Pistol Grease Gun, C/W Hose, H.D.	2 ea.
11085A	Lever Grease Gun, H.D.	2 ea.
11087A	Heavy Duty Pistol Grease Gun	2 ea.
11090A	Suction Gun	2 ea.
11092A	Lever Action Barrel Pump	2 ea.
11100A	Dynapak Grease Fitting, 1/8" Straight	1 Pkg. of 10
11102A	Dynapak Grease Fitting, 1/8" 45°	1 Pkg. of 5
11104A	Dynapak Grease Fitting, 1/8" 90°	1 Pkg. of 5
11105A	Dynapak Grease Fitting, 1/4" Straight	1 Pkg. of 5
11106A	Dynapak Grease Fitting, 1/4" Long	1 Pkg. of 10
11107A	Dynapak Grease Fitting, 1/4" 45°	1 Pkg. of 5
11109A	Dynapak Grease Fitting, 1/4" 90°	1 Pkg. of 5
11110A	Dynapak Grease Fitting, 1/4" Straight	1 Pkg. of 5
11112A	Dynapak Grease Fitting, 5/16" Straight	1 Pkg. of 5
11113A	Dynapak Grease Fitting, 3/8" Straight	1 Pkg. of 5
11114A	Dynapak Grease Fitting, M6 X 1 Straight	1 Pkg. of 5
11115A	Dynapak Grease Fitting, M6 X 1 45°	1 Pkg. of 5
11116A	Dynapak Grease Fitting, M6 X 1 90°	1 Pkg. of 5
11117A	Dynapak Grease Fitting, M8 X 1 Straight	1 Pkg. of 5
11118A	Dynapak Grease Fitting, M8 X 1 45°	1 Pkg. of 5
11119A	Dynapak Grease Fitting, M8 X 1 90°	1 Pkg. of 5
11120A	Dynapak Grease Fitting, M10 X 1 Str.	1 Pkg. of 5
11121A	Dynapak Grease Coupler, 6000 Psi	2 ea.
11123A	Grease Injector, 18Ga	2 ea.

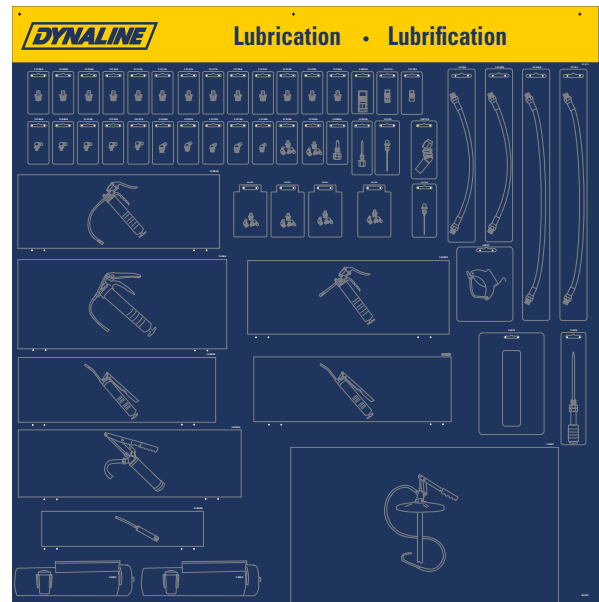

PART#	DESCRIPTION	QUANTITY
11124A	Grease Injector, (1) 18Ga, (1) 21Ga	1 Pkg. of 2
11125A	Heavy Duty Grease Coupler	2 ea.
11126A	Dynapak Grease Fitting, M10 X 1, 45°	1 Pkg. of 5
11127A	Dynapak Grease Fitting, M10 X 1, 90°	1 Pkg. of 5
11131A	Dynapak Grease Fitting, 3/16" Drive-In	1 Pkg. of 5
11132A	Dynapak Grease Fitting, 1/4" Drive-In	1 Pkg. of 5
11133A	Dynapak Grease Fitting, 5/16" Drive-In	1 Pkg. of 5
11134A	Dynapak Grease Fitting, 3/8" Drive-In	1 Pkg. of 5
11135A	S.A.E. Grease Fittings, Dynapak	1 Pkg. of 10
11136A	Metric Grease Fittings, Dynapak	1 Pkg. of 10
11142A	Grease Hose 12"	2 ea.
11143A	Grease Hose 18"	2 ea.

Plastic Funnels & Measurers

PART#	CONTENTS	
00626	Plastic Funnels & Measurers Backdrop 48" x 48".	
00626K	Plastic Funnels & Measurers Plan-o-gram. Includes 00626.	
PART#	DESCRIPTION	QTY.
13003	Funnel with Filter, 3"	10 ea.
13005	Funnel with Filter, 5"	12 ea.
13008	Automotive with Filter	8 ea.
13009	Funnel with Filter, 9"	4 ea.
13015	Anti-Splash Funnel, 5"	10 ea.
13019	Anti-Splash Funnel, 9"	5 ea.
13504	Multi-Purpose Funnel, 4"	10 ea.
13505	Multi-Purpose Funnel, 5"	10 ea.
13506	Multi-Purpose Funnel, 6"	10 ea.
13508	Multi-Purpose Funnel, 8"	10 ea.
14015	2-in-1 Flexible Spout	3 ea.
14017	Transmission Funnel (plastic), 16" spout	2 ea.
14022	Drain Pan, 16 L	2 ea.
14023	Drain Pan, 24 L	2 ea.
14025	Measurer, 2.5 L	2 ea.
14045	Measurer, 4.5 L	2 ea.

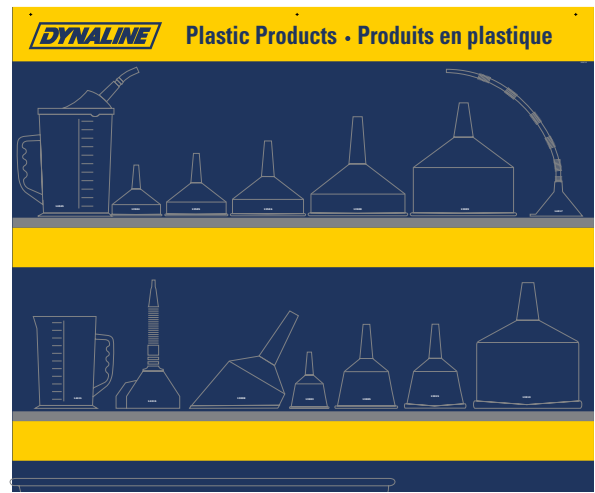

Dynaline Plan-O-Grams do not include gondola or shelves.
Products may not be exactly as illustrated.

Lubrication Plan-O-Gram



PART#	DESCRIPTION	QTY.
11113A	Dynapak Grease Fitting, 3/8" Straight	1 pkg. of 5
11114A	Dynapak Grease Fitting, M6 X 1 Straight	1 pkg. of 5
11115A	Dynapak Grease Fitting, M6 X 1 45°	1 pkg. of 5
11116A	Dynapak Grease Fitting, M6 X 1 90°	1 pkg. of 5
11117A	Dynapak Grease Fitting, M8 X 1 Straight	1 pkg. of 5
11118A	Dynapak Grease Fitting, M8 X 1 45°	1 pkg. of 5
11119A	Dynapak Grease Fitting, M8 X 1 90°	1 pkg. of 5
11120A	Dynapak Grease Fitting, M10 X 1 Straight	1 pkg. of 5
11121A	Dynapak Grease Coupler, 6000 PSI	1 ea.
11123A	Grease Injector, 18 Ga	1 ea.
11124A	Grease Injector (1)18 Ga, (1) 21 Ga	1 pkg. of 2
11125A	Heavy Duty Grease Coupler (1 Per Pkg.)	1 pkg.
11126A	Dynapak Grease Fitting, M10 X 1 45°	1 pkg. of 5
11127A	Dynapak Grease Fitting, M10 X 1 90°	1 pkg. of 5
11131A	Dynapak Grease Fitting, 3/16", Drive In	1 pkg. of 5
11132A	Dynapak Grease Fitting, 1/4", Drive-in	1 pkg. of 5
11133A	Dynapak Grease Fitting, 5/16", Drive-in	1 pkg. of 5
11134A	Dynapak Grease Fitting, 3/8", Drive-in	1 pkg. of 5
11135A	S.A.E. Grease Fittings Dynapak	1 pkg. of 10
11136A	Metric Grease Fittings Dynapak	1 pkg. of 10
11142A	Grease Hose 12"	1 ea.
11143A	Grease Hose 18"	1 ea.

PART#	CONTENTS
00063	Lubrication Backdrop 48" x 72".
00063K	Lubrication Plan-o-gram. Includes 00063, 66 pegs (80004), and contents listed below.

PART#	DESCRIPTION	QTY.
00163	S.A.E. Grease Fitting Dynakit, 40 Pcs.	1 ea.
00181	Metric Grease Fittings Dynakit, 50 Pcs.	1 ea.
00182	Drive-in Grease Fittings Dynakit, 50 Pcs.	1 ea.
11060	Rechargeable Grease Gun Kit, 12V	1 ea.
11066	Professional Pistol Grease Gun	1 ea.
11073	Multi-Purpose Lithium Grease, 3 X 85G	1 pkg. of 3
11076	Needle Nose Adapter, 4"	1 ea.
11077	Grease Gun Holder Bracket	1 ea.
11078	Replacement Grease Gun Pipe, 5 1/2"	1 ea.
11091	Lever Action Pail Pump	1 ea.
11093	Fluid Transfer Pump	1 ea.
11122	Grease Injector, 18 ga.	1 pkg. of 3
11140	Grease Hose, 12"	1 ea.
11141	Grease Hose, 18"	1 ea.
13000	Tube Tote - Grease	1 ea.
13002	2 Tube Grease Holder	1 ea.
14022	Drain Pan - 16 Litres	1 ea.
14023	Drain Pan - 24 Litres	1 ea.
11071A	360° Swivel Coupler, 1/8" Npt	1 ea.
11075A	Needle Nose Dispenser, 1 1/2"	1 ea.
11080A	Needle Nose Adapter, Fine	1 ea.
11081A	90° Angle Grease Coupler	1 ea.
11082C	Professional Lever Grease Gun	1 ea.
11084A	Pistol Grease Gun, C/W hose, heavy duty	1 ea.
11087A	Heavy Duty Pistol Grease Gun	1 ea.
11089A	Mini Pistol Grease Gun	1 ea.
11090A	Suction Gun	1 ea.
11094A	Rotary Barrel Pump	1 ea.
11100A	Dynapak Grease Fitting, 1/8", Straight	1 pkg. of 10
11102A	Dynapak Grease Fitting, 1/8", 45°	1 pkg. of 5
11104A	Dynapak Grease Fitting, 1/8", 90°	1 pkg. of 5
11105A	Dynapak Grease Fitting, 1/4", Straight	1 pkg. of 5
11106A	Dynapak Grease Fitting, 1/4", Long	1 pkg. of 10
11107A	Dynapak Grease Fitting, 1/4", 45°	1 pkg. of 5
11109A	Dynapak Grease Fitting, 1/4", 90°	1 pkg. of 5
11110A	Dynapak Grease Fitting, 1/4", Straight	1 pkg. of 5
11112A	Dynapak Grease Fitting, 5/16", Straight	1 pkg. of 5

Trailer & Towing Plan-O-Gram

PART#	CONTENTS	
01041	Trailer & Towing Backdrop (48" x 48")	
01041K	Trailer & Towing Plan-O-Gram. Includes 01041, 21 pegs (80004), and contents listed below.	
PART#	DESCRIPTION	QTY.
00210	Ball Mount Display Rack	1 ea.
11147P	Trailer Ball, 1-7/8" x 1", External Thread, Pkgd.	2 ea.
11148P	Trailer Ball, 1-7/8" x 3/4", Internal Thread, Pkgd.	2 ea.
11149P	Trailer Ball, 2" x 3/4", Internal Thread, Pkgd.	2 ea.
11151P	Trailer Ball, 1-7/8" x 3/4", External Thread, Pkgd.	2 ea.
11152P	Trailer Ball, 2" x 3/4", External Thread, Pkgd.	2 ea.
11153P	Trailer Ball, 2" x 1", External Thread, Pkgd.	2 ea.
11156	Trailer Coupler, 1-7/8" x 2"	2 ea.
11157	Trailer Coupler, 1-7/8" x 2-1/2"	2 ea.
11158	Trailer Coupler, 1-7/8" x 3"	2 ea.
11159	Trailer Coupler, 2" x 2-1/2"	2 ea.
11159N	Trailer Coupler, 2" x 2"	2 ea.
11160	Trailer Coupler, 2" x 3"	2 ea.
11170	Trailer Ball Reducer, Bushing 1" to 3/4"	2 ea.
11171	Trailer Ball Reducer, Bushing 1-1/4" to 1"	2 ea.
11305	Hand Winch, 2000 lb	1 ea.
11310	Hand Winch Auto Brake, 2500 lb	1 ea.
11579	Ball Mount - Clevis	1 ea.
11591	Ball Mount Kit, 2"	1 ea.
11592	Ball Mount Kit, 2-5/16"	1 ea.
11600	Straight Bar Ball Mount	1 ea.
11601	Ball Mount, 2" Drop	1 ea.
11602	Ball Mount, 4" Drop	1 ea.
11607	Triple Ball Mount	1 ea.
11615	Pintle Hook, 8 Ton	1 ea.
11616	Pintle Hook, 2" Ball	1 ea.
11617	Pintle Hook, 2-5/16" Ball	1 ea.
11618	Pintle Hook, 5 Ton	1 ea.
11619	Pintle Hook, 15 Ton	1 ea.
11620	Pintle Hook, 10 Ton	1 ea.
11670	Ball Mount, 1-1/4" Shank	1 ea.
11671	Ball Mount, 1-1/4" Shank	1 ea.
11686	Ball Mount, Forged	1 ea.
11690	Ball Mount, 1-1/4", Super Duty	1 ea.
11693	Shackle Ball Mount, 9-3/8"	1 ea.
11786	Hitch Adapter, 2" to 1-1/4"	1 ea.
11787	Hitch Adapter, 1-1/4" to 2"	1 ea.
11788	Hitch Adapter, 2" to 1-1/4"	1 ea.



00210K Ball Mount Rack
00210 (rack only)
See Tow Pro

PART#	DESCRIPTION	QTY.
66270	Pull Pin, 1/2"	2 ea.
66271	Pull Pin, 5/8, 3" Usable Length	2 ea.
66271P	Pull Pin, 5/8", 3" Usable Length - Pkgd.	2 ea.
66274	Hitch Lock Pin, 1/2" x 2-1/2"	2 ea.
66275	Hitch Lock Pin, 5/8" x 3"	2 ea.
66276	Coupler Lock	2 ea.
66277	Coupler & Receiver Lock Set	2 ea.

Trailer & Towing Plan-O-Gram



PART#	DESCRIPTION	QUANTITY
11616	Pintle Hook, 2" Ball	1 ea.
11617	Pintle Hook, 2-5/16" Ball	1 ea.
11618	Pintle Hook, 5 Ton	1 ea.
11619	Pintle Hook, 15 Ton	1 ea.
11620	Pintle Hook, 10 Ton	1 ea.
11670	Ball Mount, 1-1/4" Shank	1 ea.
11671	Ball Mount, 1-1/4" Shank	1 ea.
11686	Ball Mount, Forged	1 ea.
11690	Ball Mount, 1-1/4", Super Duty	1 ea.
11693	Shackle Ball Mount, 9-3/8"	1 ea.
11786	Hitch Adapter, 2" to 1-1/4"	1 ea.
11787	Hitch Adapter, 1-1/4" to 2"	1 ea.
11788	Hitch Adapter, 2" to 1-1/4"	1 ea.
66270	Pull Pin, 1/2"	2 ea.
66271	Pull Pin, 5/8, 3" Usable Length	2 ea.
66271P	Pull Pin, 5/8", 3" Usable Length - Pkgd.	2 ea.
66274	Hitch Lock Pin, 1/2" x 2-1/2"	2 ea.
66275	Hitch Lock Pin, 5/8" x 3"	2 ea.
66276	Coupler Lock	2 ea.
66277	Coupler & Receiver Lock Set	2 ea.

PART#	CONTENTS
00057	Trailer & Towing Backdrop (48" x 72")
00057K	Trailer & Towing Plan-O-Gram. Includes 00057, 21 pegs (80004), and contents listed below.

PART#	DESCRIPTION	QUANTITY
00210	Ball Mount Display Rack	1 ea.
00637	Jack Rack for Gondola	1 ea.
11147P	Trailer Ball, 1-7/8" x 1", External Thread, Pkgd.	1 ea.
11148P	Trailer Ball, 1-7/8" x 3/4", Internal Thread, Pkgd.	1 ea.
11149P	Trailer Ball, 2" x 3/4", Internal Thread, Pkgd.	1 ea.
11151P	Trailer Ball, 1-7/8" x 3/4", External Thread, Pkgd.	1 ea.
11152P	Trailer Ball, 2" x 3/4", External Thread, Pkgd.	1 ea.
11153P	Trailer Ball, 2" x 1", External Thread, Pkgd.	1 ea.
11156	Trailer Coupler, 1-7/8" x 2"	1 ea.
11157	Trailer Coupler, 1-7/8" x 2-1/2"	1 ea.
11158	Trailer Coupler, 1-7/8" x 3"	1 ea.
11159	Trailer Coupler, 2" x 2-1/2"	1 ea.
11159N	Trailer Coupler, 2" x 2"	1 ea.
11160	Trailer Coupler, 2" x 3"	1 ea.
11170	Trailer Ball Reducer, Bushing 1" to 3/4"	2 ea.
11171	Trailer Ball Reducer, Bushing 1-1/4" to 1"	2 ea.
11305	Hand Winch, 2000 lb	1 ea.
11310	Hand Winch Auto Brake, 2500 lb	1 ea.
11468	Imp. Jack, Top Wind, Tube Mnt, 5000 lb, 10" Lift	1 ea.
11469	Imp. Jack, Top Wind Tube Mnt, 5000 lb, 15" Lift	1 ea.
11471	Imp. Jack, Top Wind, Swivel Mnt, 2000 lb, 15" Lift	1 ea.
11472	Imp. Jack, Side Wind, Tube Mnt, 5000 lb, 15" Lift	1 ea.
11473	Imp. Jack, Side Wind, Tube Mnt, 5000 lb, 10" Lift	1 ea.
11545	Square Tube Jack, Side Wind, 5000 lb, 15" Lift	1 ea.
11579	Ball Mount - Clevis	1 ea.
11591	Ball Mount Kit, 2"	1 ea.
11592	Ball Mount Kit, 2-5/16"	1 ea.
11600	Straight Bar Ball Mount	1 ea.
11601	Ball Mount, 2" Drop	1 ea.
11602	Ball Mount, 4" Drop	1 ea.
11607	Triple Ball Mount	1 ea.
11615	Pintle Hook, 8 Ton	1 ea.

Jacks Display Merchandiser

PART#	CONTENTS
00636	Jack Rack/Stand only (23" x 18" x 66-1/2") Free standing floor rack for Trailer Jacks
00636K	Jacks Merchandiser. Includes 00636 Jack Rack. Dimensions: 23" x 18" x 66-1/2"

PART#	DESCRIPTION	QTY.
11466	"Swing-Way" Boat Jack, 1200 lb	2 ea.
11468	Tube Mount Top Wind Implement Jack, 5000 lb	2 ea.
11469	Tube Mount Top Wind Implement Jack, 5000 lb	2 ea.
11472	Tube Mount Side Wind Implement Jack, 5000 lb	2 ea.
11473	Tube Mount Side Wind Implement Jack, 5000 lb	2 ea.



Jacks slide into place and will not fall!

Jack Rack Merchandiser

JACK RACK MERCHANDISER CAN BE PLACED ON FLOOR OR BOTTOM OF A GONDOLA SHELF.

FITS REGULAR 4 FT. GONDOLA SHELF, 18" DEEP.

PART#	CONTENTS
00637	Jack Stand Bracket, 1 piece display (bolts not included)
00637K	Jack Rack Merchandiser. Includes 00637 Jack Rack for Gondola shelf and labels

PART#	DESCRIPTION	QTY.
11468	Implement Jack, Tube Mount, Top Wind, 5000 lb, 10" Lift	2 ea.
11469	Implement Jack, Tube Mount, Top Wind, 5000 lb, 15" Lift	2 ea.
11471	Swivel Bracket Mount, 2000 lb, 15" Lift	2 ea.
11472	Implement Jack, Tube Mount, Side Wind, 5000 lb, 15" Lift	2 ea.
11473	Implement Jack, Tube Mount, Side Wind, 5000 lb, 10" Lift	2 ea.
11545	Tube Mount, Side Wind, Square Tube, 5000 lb, 15" Lift	2 ea.

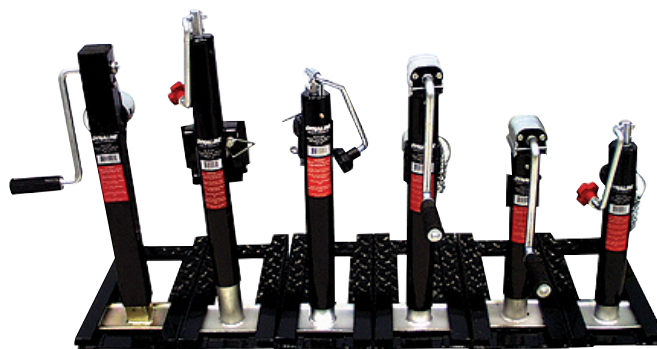

See Trailer & Towing Merchandiser 00057K on previous page

Trailer Connectors



PART#	CONTENTS	
01042	Trailer Connectors Backdrop (48" x 48")	
01042K	Tow Pro Trailer Connectors Plan-o-gram. Includes 01042 and 35 pgs (80004)	
PART#	DESCRIPTION	QTY.
27002	2 Pole Flat Connector	2 ea.
27004	4 Pole Flat Connector, 18 ga. Wire	2 ea.
27006	4 Pole Flat Connector	2 ea.
27008	4 Pole Flat Connect, 25 ft. Loop	2 ea.
27010	Heavy Duty 4 Pole Connector	2 ea.
27015	4 Pole Round Plug & Socket	2 ea.
27020	5 Pole Flat Male Connector	2 ea.
27022	5 Pole Flat Female Connector	2 ea.
27030	6 Pole HD Plug & Socket	2 ea.
27034	6 Pole Round Socket-Heavy Duty	2 ea.
27036	6 Pole Plug, Heavy Duty	2 ea.
27040	Mounting Bracket for 7 Way Trailer Connectors	2 ea.
27042	7-Way Socket, Vehicle Side	2 ea.
27044	7-Way Blade Plug	2 ea.
27046	7-Way Plug & Socket With Cover	2 ea.
27048	7-Way Socket, Plastic Housing - Vehicle Side	2 ea.
27050	7-Way Plug-in Plastic Housing - Trailer Side	2 ea.
27052	7-Way Socket & 4-Way Plug Set - Vehicle Side	2 ea.
27056	7-Way Socket & 4-Way Plug plus Mounting Kit	2 ea.
27060	7-Way Plug, Heavy Duty - Trailer Side	2 ea.
27062	7-Way Socket, Heavy Duty - Vehicle Side	2 ea.
27064	7-Way Plug, ABS Housing - Trailer Side	2 ea.
27066	7-Way Socket, ABS Housing - Vehicle Side	2 ea.
27068	7-Way Socket, Heavy Duty - Vehicle Side	2 ea.
27076	4-Way In-Line Adapter	2 ea.
27078	Trailer Adapter, 6-Way Round	2 ea.
27080	Trailer Adapter, 7-Way Round	2 ea.
27082	Trailer Adapter, 7-Way Round to 6 Way	2 ea.
27084	Trailer Adapter, 7-Way Round to 4 Way	2 ea.
27086	Adapter, 7-Way Rnd. to 6-Way; 5-Way Flat to 4 Way	2 ea.
27088	Adapter, 7-Way Blade, Male to Female	2 ea.
27090	4-Way Flat Connector with cover	2 ea.
27092	4-Way Flat Tester	2 ea.
27093	4-Way & 5-Way Flat Tester	2 ea.
27096	7-Way Blade Tester	2 ea.
27098	Breakaway Switch, 4 ft. 16 ga. Wire	2 ea.
27024	5 Way Pole Flat Connector - Heavy Duty	2 ea.
11978	LED Magnetic Towing Light Kit	2 ea.
11980	LED Submersive Towing Light Kit	2 ea.

Cargo Control

PART#	CONTENTS
01052	Cargo Control Backdrop (48" x 48")
01052K	Cargo Control Plan-o-gram. Includes 01052 and products listed below

PART#	DESCRIPTION	QUANTITY
11182	Cam Strap, 1" x 6'	2 ea.
11183	Ratchet Strap, 1" x 15'	2 ea.
11183B	Ratchet Strap, 1" x 15' - Bulk	15 ea.
11185	Cam Strap, 1" x 10' - H.D.	2 ea.
11186	Ratchet Strap, 1-1/2" x 25' - H.D.	2 ea.
11186B	Ratchet Strap, 1-1/2" x 25' - H.D. - Bulk	6 ea.
11189B	Ratchet Strap, 1" x 15' - Bulk	12 ea.
11190	Ratchet Strap, 2" x 27' - H.D.	2 ea.
11190B	Ratchet Strap, 2" x 27' - H.D. - Bulk	10 ea.
12207	Ratchet Strap, 1" x 15', Steel Hook	2 ea.
12251	Recessed Anchor, 3-1/2"	2ea.
12252	Recessed Anchor, 4-7/16" - HD	2 ea.
12320	Ratchet Strap, 1" x 15', Four Pack	2 ea.
12321	Ratchet Strap, 1" x 15', Four Pack	2 ea.
12340	Ratchet Strap, 1" x 15', J-Hooks	2 ea.
12341	Ratchet Strap, 2" x 15', J-Hooks	2 ea.
50921	Recovery Strap, 3" x 20' - 13,500 lb	2 ea.
50922	Recovery Strap, 4" x 20' - 17,500 lb	2 ea.



Ball Mount Rack

PART#	CONTENTS
00210	Ball Mount Rack Only 48" x 15" x 10"
00210K	Ball Mount Rack. Includes an assortment of our most popular ball mounts and receivers.

PART#	DESCRIPTION	QUANTITY
11686	Ball Mount, Forged, 2" Drop	1 ea.
11690	Ball Mount 1-1/4" Super Duty, 3" Drop	1 ea.
11693	Shackle Ball Mount	1 ea.
11786	Hitch Adaptors - 2 to 1-1/4	1 ea.
11787	Hitch Adaptor - 2 to 1-1/4	1 ea.
11788	Hitch Adaptor 1-1/4 to 2	1 ea.

PART#	DESCRIPTION	QUANTITY
11579	Clevis Ball Mount 5000lb	1 ea.
11591	Ball Mount Kit 2	1 ea.
11592	Ball Mount Kit 2-5/16	1 ea.
11600	Straight Bar Ball Mount	1 ea.
11601	Ball Mount 2" Drop	1 ea.
11602	Ball Mount 4" Drop	1 ea.
11607	Triple Ball Mount	1 ea.
11670	Ball Mount, 1-1/4" Shank	1 ea.
11671	Ball Mount, 1-1/4" Shank	1 ea.



General Hardware

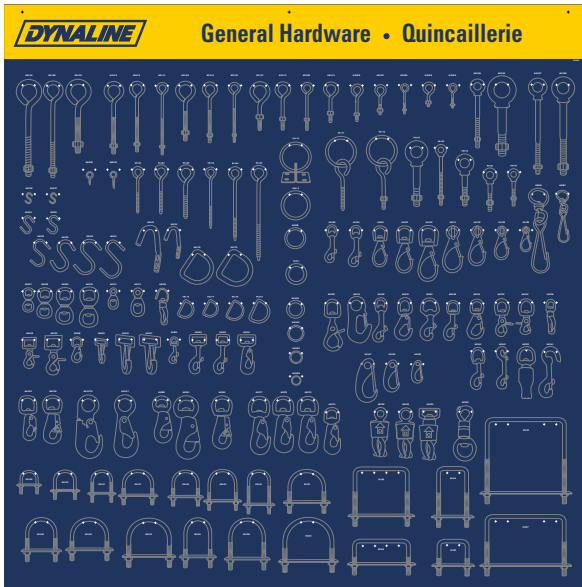

ITEM	PART#	DESCRIPTION	QTY.
	65145	5/16" x 1-3/4"	1 pkg. of 10
	65146	5/16" x 1-3/4"	1 pkg. of 10
	65147	5/16" x 2"	1 pkg. of 10
	65148	5/16" x 2"	1 pkg. of 10
	65149	5/16" x 2-1/2"	1 pkg. of 10
	65150	5/16" x 2-1/2"	1 pkg. of 10
	65151	3/8" x 2-1/2"	1 pkg. of 10
	65152	3/8" x 3"	1 pkg. of 10
	65153	3/8" x 3-1/2"	1 pkg. of 10
	65161	1/4"	1 pkg. of 10
Lagscrew Eyebolts	65162	1/4"	1 pkg. of 10
	65163	5/16"	1 pkg. of 10
	65164	5/16"	1 pkg. of 10
	65165	3/8" x 4"	1 pkg. of 10
	65166	3/8" x 8"	1 pkg. of 10
Rings	65172	W/Eyebolt	1 pkg. of 10
	65177	W/Lagscrew Eyebolt	1 pkg. of 10
	65178	W/Mounting Plate	1 pkg. of 10
ITEM	PART#	DESCRIPTION	QUANTITY
Square U-Bolts	65181	3/8" - 2" x 3"	1 pkg. of 5
	65182	3/8" - 2" x 5"	1 pkg. of 5
	65184	3/8" - 4" x 3"	1 pkg. of 5
	65185	3/8" - 4" x 5"	1 pkg. of 5
	65187	3/8" - 6" x 5"	1 pkg. of 5

PART#

CONTENTS

01081	General Hardware Backdrop (48" x 48")		
01081K	General Hardware Plan-o-gram. Includes 01081 and 110 pegs (80004)		
ITEM	PART#	DESCRIPTION	QTY.
Bolt Snaps	64100	1/2", S.S.	1 pkg. of 5
	64101	3/4", S.S.	1 pkg. of 5
	66343	3/4"	1 pkg. of 5
	66340	11/16"	1 pkg. of 5
	66366	3-1/4"	1 pkg. of 5
	66383	5"	1 pkg. of 5
	66360	Brass, 1/2" x 3"	1 pkg. of 5
Double Bolt Snap	66342	7/16"	1 pkg. of 5
Security Snaps	64102	5/8"	1 pkg. of 5
	64103	3/4"	1 pkg. of 5
	64104	7/8"	1 pkg. of 5
Spring Snaps	64105	1/4"	1 pkg. of 5
	64106	3/8"	1 pkg. of 5
	64107	1/2"	1 pkg. of 5
	66351	1"	1 pkg. of 5
Boat Snaps	64108	1/2"	1 pkg. of 5
	64109	5/8"	1 pkg. of 5
	64110	3/4"	1 pkg. of 5
	64111	3/4"	1 pkg. of 5
Eyebolts	65102	3/16" x 2"	1 pkg. of 10
	65104	3/16" x 2-1/2"	1 pkg. of 10
	65106	1/4" x 2"	1 pkg. of 10
	65107	1/4" x 2-1/2"	1 pkg. of 10
	65108	1/4" x 3"	1 pkg. of 10
	65109	1/4" x 4"	1 pkg. of 10
	65110	1/4" x 5"	1 pkg. of 10
	65111	1/4" x 6"	1 pkg. of 10
	65112	5/16" x 3-1/4"	1 pkg. of 10
	65113	5/16" x 4"	1 pkg. of 10
	65114	5/16" x 5"	1 pkg. of 10
	65115	5/16" x 6"	1 pkg. of 10
	65117	3/8" x 4"	1 pkg. of 10
	65118	3/8" x 5"	1 pkg. of 10
	65119	3/8" x 6"	1 pkg. of 10
	65120	3/8" x 8"	1 pkg. of 10
	65123	1/2" x 6"	1 pkg. of 10
	65124	1/2" x 8"	1 pkg. of 10
U-Bolts	65140	1/4" x 1-1/8"	1 pkg. of 10
	65141	1/4" x 1-3/8"	1 pkg. of 10
	65142	1/4" x 2"	1 pkg. of 10
	65143	5/16" x 1-3/8"	1 pkg. of 10
	65144	5/16" x 1-3/8"	1 pkg. of 10

General Hardware Continued

ITEM	PART#	DESCRIPTION	QTY.
	65188	3/8" - 6" x 7"	1 pkg. of 5
Shoulder Eyebolts	66100	1/4" x 2"	2 ea.
	66101	5/16" x 2-1/4"	2 ea.
	66102	3/8" x 2-1/2"	2 ea.
	66103	1/2" x 3-1/4"	2 ea.
	66104	5/8" X 4"	2 ea.
	66105	1/4" x 4"	2 ea.
	66106	5/16" x 4-1/4"	2 ea.
	66107	3/8" x 6"	2 ea.
	66108	1/2" x 6"	1 ea.
Safety Lanyard Hooks	66137	Single Latch	2 ea.
	66137S	Double Latch	2 ea.
D-Rings	66173	1" x 7/8"	1 pkg. of 10
	66174	1-1/8" x 7/8"	1 pkg. of 10
	66175	1-5/16" x 1"	1 pkg. of 10
	66176	1-5/8" x 1-1/8"	1 pkg. of 10
	66178	2" x 1-3/4", H.D.	1 pkg. of 10
	O-Rings	66179	H.D.
Key Rings	66180	5/8" I.D.	1 pkg. of 10
	66182	1" I.D.	1 pkg. of 10
	66184	1-1/4" I.D.	1 pkg. of 10
	S-Hooks	66230	1"
	66232	1-3/32"	1 pkg. of 10
	66234	1-3/8"	1 pkg. of 10
	66235	1-1/2"	1 pkg. of 10
	66236	2-1/8"	1 pkg. of 10
	66238	2-5/8"	1 pkg. of 10
	66239	2-7/8"	1 pkg. of 10
Tarp Strap Hook	66241	--	1 pkg. of 10
Bull Snap	66330	--	1 pkg. of 5
Solid Snap Hook	66331	11/16"	1 pkg. of 5
Cap Snap	66332	1"	1 pkg. of 5
Swivel Eye Snaps	66334	11/16"	1 pkg. of 5
	66335	13/16"	1 pkg. of 5
Dog Lead Snaps	66336	3/8"	1 pkg. of 5
	66338	Panic Snap, 1/2"	1 pkg. of 5
Trigger Snaps	66339	5/8"	1 pkg. of 5
	66344	3/4"	1 pkg. of 5
	66349	1"	1 pkg. of 5



ITEM	PART#	DESCRIPTION	QTY.
	66350	13/16"	1 pkg. of 5
Sq. Trigger Snap	66348	3/4"	1 pkg. of 5
Open Eye Snap	66341	13/16"	1 pkg. of 5
Loop Snaps	66346	3/4"	1 pkg. of 5
	66347	1"	1 pkg. of 5
Swivel Loop Snaps	66352	3/4"	1 pkg. of 5
	66353	1"	1 pkg. of 5
Mini Bolt Snaps	66354	7/16"	1 pkg. of 5
Open Decoy Snap	66355	1/2" x 2-1/2"	1 pkg. of 5
Flat Spring Snaps	66356	Simplex	1 pkg. of 5
	66361	1"	1 pkg. of 5
Square Eye Snap	66365	5/8" (Baby)	1 pkg. of 5
Zinc Swivel Snaps	66367	1/2"	1 pkg. of 5
	66368	5/8"	1 pkg. of 5
	66369	3/4"	1 pkg. of 5
	66370	1"	1 pkg. of 5
Swivel Eye Snaps	66371	1/2"	1 pkg. of 5
	66372	3/8"	1 pkg. of 5
Lever Snaps	66374	5/8", Nickel Plated	1 pkg. of 5
	66375	3/4", Nickel Plated	1 pkg. of 5
	66376	1", Nickel Plated	1 pkg. of 5
	66377	1-1/8"	1 pkg. of 5
Security Snaps	66380	7/8"	1 pkg. of 5
	66381	1"	1 pkg. of 5
Eye Bull Snap	66385	3/4" x 3-3/4"	1 pkg. of 5
Swivel Spring Snap	66387	Simplex	1 pkg. of 5
Harness Ring	66390	1-1/4"	1 pkg. of 5
Animal Snap	66392	1", bronze cast	1 pkg. of 5
Security Snap	66394	1", swivel	1 pkg. of 5
Steel Rings	66410	1/4" x 1"	1 pkg. of 10
	66411	5/16" x 1-1/8"	1 pkg. of 10
	66412	7/32" x 2"	1 pkg. of 10
Tarp Hooks	66423	3/8" x 3-1/2"	1 pkg. of 10
	66424	1/4" x 2-1/2"	1 pkg. of 10
Screweyes	65018	1-5/16"	1 pkg. of 10
	65020	15/16"	1 pkg. of 10



Farm Hardware

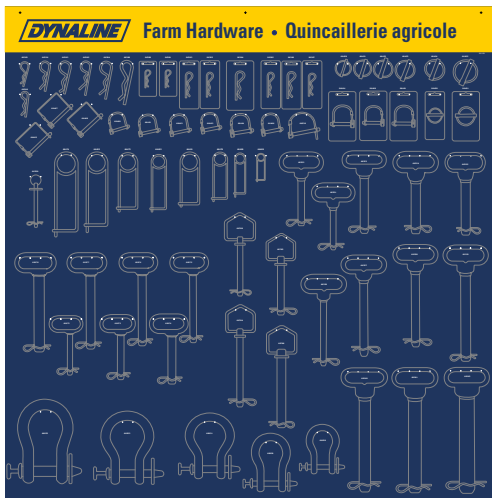

PART#	DESCRIPTION	QUANTITY
66474	Safety Pin, 1/4"	1 pkg. of 5
66489	Safety Pin, .091	1 pkg. of 10
66490	Safety Pin, 0.12	1 pkg. of 10
66491	Safety Pin, 0.177	1 pkg. of 5
66492	Safety Pin, 0.148	1 pkg. of 5
66493	Safety Pin, 0.243	1 pkg. of 5
66536	Tab Quick Pin Round, 5/16 x 2-3/4"	1 pkg. of 5
66780	Hitch Pin, 1/2" x 4-1/4"	2 ea.
66783	Hitch Pin, 3/4" x 4-1/4"	2 ea.
66784	Hitch Pin, 3/4" x 6-1/4"	2 ea.
66786	Hitch Pin, 1" x 6-1/4"	2 ea.
66872	E-Grip Hitch Pin, 1/2" x 3-1/2"	2 ea.
66873	E-Grip Hitch Pin, 5/8" x 3-3/4"	2 ea.
66874	E-Grip Hitch Pin, 3/4" x 4"	2 ea.
66875	E-Grip Hitch Pin, 5/8" x 6"	2 ea.
66876	E-Grip Hitch Pin, 3/4" x 6-1/4"	2 ea.
66877	E-Grip Hitch Pin, 7/8" x 6-1/2"	2 ea.
66878	E-Grip Hitch Pin, 1" x 6-3/4"	2 ea.
96300	Hair Pin Dynapak - 10 x 66300	2 ea.
96301	Hair Pin Dynapak - 10 x 66301	2 ea.
96302	Hair Pin Dynapak - 4 x 66302	2 ea.
96303	Hair Pin Dynapak - 10 x 66303	2 ea.
96304	Hair Pin Dynapak - 5 x 66304	2 ea.
96305	Hair Pin Dynapak - 5 x 66305	2 ea.
96306	Hair Pin Dynapak - 5 x 66306	2 ea.
96307	Hair Pin Dynapak - 10 x 66307	2 ea.
96450	Linch Pin Dynapak - 4 x 66450	2 ea.
96451	Linch Pin Dynapak - 4 x 66451	2 ea.
96460	Quick Pin Dynapak - 2 x 66460	2 ea.
96461	Quick Pin Dynapak - 2 x 66461	2 ea.
96464	Quick Pin Dynapak - 2 x 66464	2 ea.

PART#	CONTENTS	
01101	Farm Hardware Backdrop (48" x 48")	
01101K	Farm Hardware Plan-o-gram. Includes 01101 and 75 pegs (80004)	
PART#	DESCRIPTION	QUANTITY
66029	Straight Clevis, 1/2"	2 ea.
66030	Straight Clevis, 5/8"	2 ea.
66031	Straight Clevis, 3/4"	2 ea.
66032	Straight Clevis, 7/8"	2 ea.
66033	Straight Clevis, 1"	2 ea.
66250	Hitch Pin, 3/8" x 3"	2 ea.
66251	Hitch Pin, 1/2" x 3-5/8" C/W Clip	2 ea.
66252	Hitch Pin, 5/8" x 4" C/W Clip	2 ea.
66253	Hitch Pin, 3/4" x 4-1/2" C/W Clip	2ea.
66254	Hitch Pin, 7/8" x 4-1/2" C/W Clip	2 ea.
66255	Hitch Pin, 1" x 4-1/2" C/W Clip	2 ea.
66256	Hitch Pin, 5/8" x 5-1/2" C/W Clip	2 ea.
66257	Hitch Pin, 3/4" x 6-1/2" C/W Clip	2 ea.
66258	Hitch Pin, 7/8" x 6-1/2" C/W Clip	2 ea.
66259	Hitch Pin, 1" x 7-1/2" C/W Clip	2 ea.
66260	Hitch Pin, 1-1/8" x 8-1/2"	2 ea.
66261	Hitch Pin, 1-1/4" x 8-1/2"	2 ea.
66263	Hitch Pin, 1-1/2" x 8-1/2"	2 ea.
66302	Hair Pin, HP-6	1 pkg. of 25
66303	Hair Pin, HP-7	1 pkg. of 25
66304	Hair Pin, HP-8	1 pkg. of 25
66305	Hair Pin, HP-9	1 pkg. of 25
66306	Hair Pin, HP-11	1 pkg. of 25
66308	Hair Pin, HP-19	1 pkg. of 10
66326	Hair Pin, HP-10	1 pkg. of 25
66450	Linch Pin, 3/16"	1 pkg. of 10
66451	Linch Pin, 1/4"	1 pkg. of 10
66452	Linch Pin, 5/16"	1 pkg. of 10
66453	Linch Pin, 3/8"	1 pkg. of 10
66454	Linch Pin, 7/16"	1 pkg. of 10
66455	Linch Pin, 7/16"	1 pkg. of 10
66460	Quick Pin, 1/4" x 1-3/8"	1 pkg. of 5
66461	Quick Pin, 1/4" x 1-3/4"	1 pkg. of 5
66462	Quick Pin, 1/4" x 2-1/2"	1 pkg. of 5
66463	Quick Pin, 5/16" x 1-3/8"	1 pkg. of 5
66464	Quick Pin, 5/16" x 1-3/4"	1 pkg. of 5
66465	Quick Pin, 5/16" x 2-1/2"	1 pkg. of 5
66466	Quick Pin, 3/8" x 1-3/8"	1 pkg. of 5
66467	Quick Pin, 3/8" x 2-1/4"	1 pkg. of 5
66468	Quick Pin, 3/8" x 2-1/2"	1 pkg. of 5
66470	Safety Pin, 1/8"	1 pkg. of 10
66472	Safety Pin, 3/16"	1 pkg. of 5

Load Binder/Cable Puller Rack

PART#	CONTENTS
70098	1 Rack, 24" wide x 31.8" high x 20.6" deep
70098K	Cable Pullers & Load Binder Rack. Includes 24" x 24" Display Board

PART#	DESCRIPTION	QTY.
11351	Cable Puller 1 Ton	2 ea.
11352	Cable Puller 2 Ton	2 ea.
11354	Cable Puller 4 Ton	2 ea.
66196	Ratchet Load Binder 1/4 - 5/16	2 ea.
66197	Ratchet Binder 5/16 - 3/8	2 ea.
66198	Ratchet Binder 3/8 - 1/2	2 ea.
66199	Ratchet Binder 1/2 - 5/8	2 ea.
66200	Load Tightener 3/16 - 1/4	2 ea.
66202	Load Binder 3/8 - 1/2	2 ea.
66203	Load Binder 1/4 - 5/16	2 ea.
66204	Load Binder 5/16 - 3/8	2 ea.
70098	Rack Display	1 ea.



Bulk Display

PART#	CONTENTS
00032	Bulk Display Shelf with 13 removable partitions 48" x 13" - Sits on gondola shelf

Custom Labels with UPC Bar Codes for each partition.



Cable Reel Display

PART#	CONTENTS
00033	Reel Display Shelf for reel of wire rops (aircraft cable) 48" x 13" - Sits on gondola shelf

Custom Labels with UPC Bar Codes for each reel.

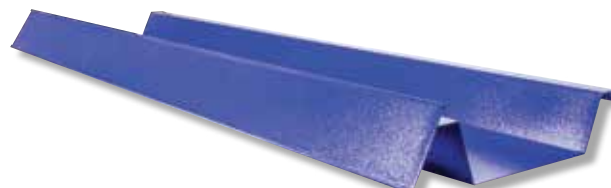

O-Ring Tilt Bins

PART# CONTENTS

00716K **O-Rings Tilt Bin Merchandiser.** Includes Tilt Bins and assembly hardware. Dimensions: 23-5/8" x 3-5/8" x 36"

PART#	DESCRIPTION	QTY.
54114	O-Ring 114	1 pkg. of 15
54115	O-Ring 115	1 pkg. of 15
54116	O-Ring 116	1 pkg. of 15
54117	O-Ring 117	1 pkg. of 10
54118	O-Ring 118	1 pkg. of 10
54119	O-Ring 119	1 pkg. of 10
54120	O-Ring 120	1 pkg. of 10
54121	O-Ring 121	1 pkg. of 10
54122	O-Ring 122	1 pkg. of 10
54123	O-Ring 123	1 pkg. of 10
54124	O-Ring 124	1 pkg. of 10
54125	O-Ring 125	1 pkg. of 10
54128	O-Ring 128	1 pkg. of 10
54210	O-Ring 210	1 pkg. of 10
54211	O-Ring 211	1 pkg. of 10
54212	O-Ring 212	1 pkg. of 10
54213	O-Ring 213	1 pkg. of 10
54214	O-Ring 214	1 pkg. of 10
54215	O-Ring 215	1 pkg. of 10
54216	O-Ring 216	1 pkg. of 10
54217	O-Ring 217	1 pkg. of 10
54218	O-Ring 218	1 pkg. of 10
54219	O-Ring 219	1 pkg. of 10
54220	O-Ring 220	1 pkg. of 10
54221	O-Ring 221	1 pkg. of 10
54222	O-Ring 222	1 pkg. of 10
54223	O-Ring 223	1 pkg. of 10
54224	O-Ring 224	1 pkg. of 10
54225	O-Ring 225	1 pkg. of 10
54226	O-Ring 226	1 pkg. of 10
54227	O-Ring 227	1 pkg. of 10
54228	O-Ring 228	1 pkg. of 10
54229	O-Ring 229	1 pkg. of 10
54230	O-Ring 230	1 pkg. of 10
54231	O-Ring 231	1 pkg. of 10
54232	O-Ring 232	1 pkg. of 10
54235	O-Ring 235	1 pkg. of 10
54236	O-Ring 236	1 pkg. of 10
54325	O-Ring 325	1 pkg. of 5
54326	O-Ring 326	1 pkg. of 5
54327	O-Ring 327	1 pkg. of 5
TF306	Tilt Bin 6 comp.	6 ea.
TF308	Tilt Bin 8 comp.	4 ea.



PART#	DESCRIPTION	QTY.
54006	O-Ring 006	1 pkg. of 15
54007	O-Ring 007	1 pkg. of 15
54008	O-Ring 008	1 pkg. of 15
54009	O-Ring 009	1 pkg. of 15
54010	O-Ring 010	1 pkg. of 15
54011	O-Ring 011	1 pkg. of 15
54012	O-Ring 012	1 pkg. of 15
54013	O-Ring 013	1 pkg. of 10
54014	O-Ring 014	1 pkg. of 10
54015	O-Ring 015	1 pkg. of 10
54016	O-Ring 016	1 pkg. of 10
54017	O-Ring 017	1 pkg. of 10
54018	O-Ring 018	1 pkg. of 10
54019	O-Ring 019	1 pkg. of 10
54020	O-Ring 020	1 pkg. of 10
54021	O-Ring 021	1 pkg. of 10
54022	O-Ring 022	1 pkg. of 10
54023	O-Ring 023	1 pkg. of 10
54024	O-Ring 024	1 pkg. of 10
54025	O-Ring 025	1 pkg. of 10
54026	O-Ring 026	1 pkg. of 10
54027	O-Ring 027	1 pkg. of 10
54028	O-Ring 028	1 pkg. of 10
54110	O-Ring 110	1 pkg. of 15
54111	O-Ring 111	1 pkg. of 15
54112	O-Ring 112	1 pkg. of 15
54113	O-Ring 113	1 pkg. of 15

Retainer Rings Tilt Bins

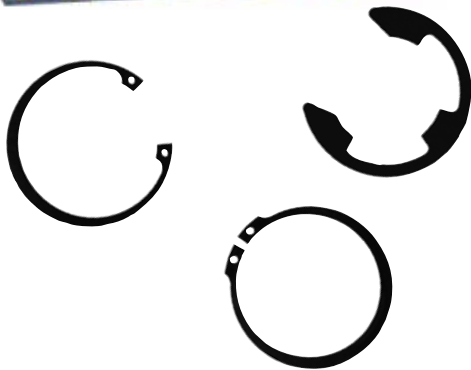

PART#	DESCRIPTION	QTY.
22934	R3100-062	1 pkg. of 10
22936	R3100-068	1 pkg. of 10
22937	R3100-075	1 pkg. of 10
22938	R3100-081	1 pkg. of 10
22939	R3100-087	1 pkg. of 10
22940	R3100-093	1 pkg. of 10
22942	R3100-100	1 pkg. of 10
22944	R3100-106	1 pkg. of 10
22945	R3100-112	1 pkg. of 10
22946	R3100-118	1 pkg. of 10
22947	R3100-125	1 pkg. of 10
22948	R3100-131	1 pkg. of 10
22949	R3100-137	1 pkg. of 10
22950	R3100-143	1 pkg. of 10
22951	R3100-150	1 pkg. of 10
22952	R3100-156	1 pkg. of 10
22953	R3100-162	1 pkg. of 10
22954	R3100-168	1 pkg. of 10
22955	R3100-175	1 pkg. of 10
22956	R3100-187	1 pkg. of 10
22958	R3100-200	1 pkg. of 10
22965	R3100-250	1 pkg. of 5
TF308	Tilt Bin 8 Comp.	8 ea.

PART#	CONTENTS
00746K	Retainer Rings Tilt Bin Merchandiser. Includes Tilt Bins and assembly hardware. Dimensions: 23-5/8" x 2-1/2" x 26-1/2"

PART#	DESCRIPTION	QTY.
22860	R1000-012	1 pkg. of 10
22861	R1000-018	1 pkg. of 10
22862	R1000-025	1 pkg. of 10
22863	R1000-031	1 pkg. of 10
22864	R1000-037	1 pkg. of 10
22865	R1000-043	1 pkg. of 10
22866	R1000-050	1 pkg. of 10
22867	R1000-062	1 pkg. of 10
22868	R1000-075	1 pkg. of 10
22869	R1000-087	1 pkg. of 10
22870	R1000-098	1 pkg. of 10
22873	R3000-025	1 pkg. of 10
22874	R3000-031	1 pkg. of 10
22875	R3000-037	1 pkg. of 10
22876	R3000-043	1 pkg. of 10
22878	R3000-050	1 pkg. of 10
22879	R3000-056	1 pkg. of 10
22880	R3000-062	1 pkg. of 10
22881	R3000-068	1 pkg. of 10
22882	R3000-075	1 pkg. of 10
22884	R3000-087	1 pkg. of 10
22886	R3000-100	1 pkg. of 10
22888	R3000-106	1 pkg. of 10
22889	R3000-112	1 pkg. of 10
22893	R3000-137	1 pkg. of 10
22895	R3000-150	1 pkg. of 10
22896	R3000-156	1 pkg. of 10
22897	R3000-162	1 pkg. of 10
22900	R3000-175	1 pkg. of 10
22901	R3000-181	1 pkg. of 10
22903	R3000-193	1 pkg. of 10
22904	R3000-200	1 pkg. of 10
22906	R3000-212	1 pkg. of 5
22907	R3000-225	1 pkg. of 5
22924	R3100-018	1 pkg. of 10
22925	R3100-025	1 pkg. of 10
22926	R3100-031	1 pkg. of 10
22928	R3100-037	1 pkg. of 10
22929	R3100-043	1 pkg. of 10
22931	R3100-050	1 pkg. of 10
22932	R3100-056	1 pkg. of 10
22933	R3100-059	1 pkg. of 10

Chain Rack - 4'

Chain Rack - 2'

Chain Rack - 4'



PART#	DESCRIPTION	QTY.
70080	Furnace Chain, #91 X 250'/Reel	1 Roll of 250'
70085	Single Jack Chain, #10T X 150'/Reel	1 Roll of 150'
70086	Single Jack Chain, #12 X 100'/Reel	1 Roll of 100'
70087	Single Jack Chain, #14 X 200'/Reel	1 Roll of 200'

PART#	CONTENTS
70099	Chain Rack only, 47" wide x 73" high x 13" deep
70099K	4' Chain Rack Merchandiser. Includes 12" x 48" Chain Rack Header

PART#	DESCRIPTION	QTY.
70003	Grade 30 Chain 3/16" X 250'/Bucket	1 Bucket of 250'
70004	Grade 30 Chain 1/4" X 141'/Bucket	1 Bucket of 141'
70005	Grade 30 Chain 5/16" X 92'/Bucket	1 Bucket of 92'
70006	Grade 30 Chain 3/8" X 63'/Bucket	1 Bucket of 63'
70024	Grade 70 Chain 1/4" X 130'/Bucket	1 Bucket of 130'
70025	Grade 70 Chain 5/16" X 90'/Bucket	1 Bucket of 90'
70026	Grade 70 Chain 3/8" X 64' per Bucket	2 Buckets of 64'
70040	Straight Link Coil Chain, #4 X 100'/Reel	1 Roll of 100'
70045	Passing Link Chain, #2/0 X 120'/Reel	1 Roll of 120'
70050	Twist Link Machine Chain, #2/0 X 75'/Reel	1 Roll of 75'
70051	Twist Link Machine Chain, #4 X 100'/Reel	1 Roll of 100'
70060	Double Loop Lion Chain, #2/0 X 150'/Reel	1 Roll of 150'
70061	Double Loop Lion Chain, #1/0 X 100'/Reel, Green PVC	1 Roll of 100'
70062	Double Loop Lion Chain, #2/0 X 125'/Reel, Blue PVC	1 Roll of 125'
70063	Double Loop Lion Chain, #3 X 200' per Reel	1 Roll of 200'
70070	Brass Safety Chain, #1/0 X 200' per Reel	1 Roll of 200'
70075	Sash Chain #35 X 100' per Reel	1 Roll of 100'

Chain Rack - 2'

PART#	CONTENTS
70010	Chain Rack only, 23" wide x 73" high x 13" deep
70010K	2' Chain Rack Merchandiser Includes 9" x 23" Dynaline Distributor sign (00003)

PART#	DESCRIPTION	QTY.
70010	Chain Rack - 2 ft.	1 ea.
70005	Grade 30 Chain, 5/16", 92' bucket	1 bucket of 92'
70007	Chain 3/16" x 100' Grade 30	1 bucket of 100'
70008	Chain 1/4" x 65' Grade 30	1 bucket of 65'
70016	Grade 30 Chain, 3/8", 45' bucket	1 bucket of 45'
70040	Straight Link Coil Chain, #4 x 100'	1 reel of 100'
70045	Passing Link Chain, #2/0 x 120'	1 reel of 120'
70050	Twist Link Mach. Chain, #2/0 x 75'	1 reel of 75'
70051	Twist Link Mach. Chain, #4 x 100'	1 reel of 100'
70060	Double Loop Lion Chain, #2/0 x 150'	1 reel of 150'
70061	Double Loop Lion Chain, #1/0 x 100'	1 reel of 100'

PART#	DESCRIPTION	QTY.
70062	Double Loop Lion Chain, #2 x 125'	1 reel of 125'
70063	Double Loop Lion Chain, #3 x 200'	1 reel of 200'
70070	Brass Safety Chain, #1/0 x 200'	1 reel of 200'
70075	Sash Chain, #35 x 100'	1 reel of 100'
70080	Furnace Chain, #91 x 250'	1 reel of 250'
70085	Single Jack Chain, #10T x 150'	1 reel of 150'
70086	Single Jack Chain, #12 x 100'	1 reel of 100'
70087	Single Jack Chain, #14 x 200'	1 reel of 200'

Chain & Steel Cable Rack Merchandiser

PART#

CONTENTS

70010 Chain & Wire Rope Rack only (23" x 13" x 73")
Free standing floor rack for Wire Rope Spools

00465K **Steel Cable Rack Merchandiser.** Includes 70010 Steel Cable Display Rack with 9" x 23" header
Dimensions: 23" x 13" x 73"

PART#	DESCRIPTION	QTY.
77010	Chain Rack - 2 ft.	1 ea.
77000	Aircraft Cable, 1/16", 500 ft. reel	1 reel of 500'
77001	Aircraft Cable, 3/32", 500 ft. reel	1 reel of 500'
77002	Aircraft Cable, 1/8", 250 ft. reel	1 reel of 250'
77003	Aircraft Cable, 5/32", 250 ft. reel	1 reel of 250'
77004	Aircraft Cable, 3/16", 250 ft. reel	1 reel of 250'
77005	Aircraft Cable, 1/4", 250 ft. reel	1 reel of 250'
77006	Aircraft Cable, 5/16", 250 ft. reel	1 reel of 250'
77007	Aircraft Cable, 3/8", 250 ft. reel	1 reel of 250'
77020	Wire Rope, 1/2", 100 ft. reel	1 reel of 100'
70040	Straight Link Coil Chain, #4, 100' reel	1 reel of 100'
70045	Passing Link Chain, #2/0, 120' reel	1 reel of 120'
70007	Grade 30 Chain, 3/16", 100' bucket	1 bucket of 100'
70005	Grade 30 Chain, 5/16", 92' bucket	1 bucket of 92'
70008	Grade 30 Chain, 1/4", 65' bucket	1 bucket of 65'
70016	Grade 30 Chain, 3/8", 45' bucket	1 bucket of 45'



7x7

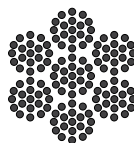

7x19

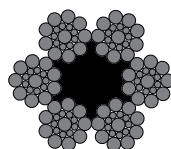

6x19



Stackable Chain Pail Display

PART#

CONTENTS

70096 **Stackable Chain Pail Display**
14-1/2" x 13-1/2" x 19-1/2"



Small Wheel Rack Merchandiser

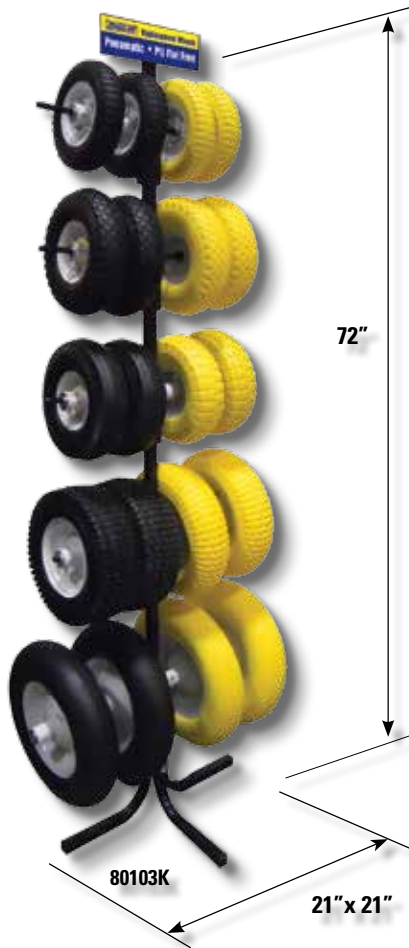

PART#

CONTENTS

80103	1 Small Freestanding Wheel Rack, 21" wide x 72" high x 21" deep.
80103K	An assortment of pneumatic and flat free wheels on this space saving wheel rack. Rack is individually boxed, complete with hardware. All metal construction with black enamel painted finish. Includes: 10" x 3" Dynaline "Replacement Wheels" decal.



PART#

DESCRIPTION

QTY.

80103	Small Wheel Rack	1 ea.
80101	Pneumatic Wheel - 8.5"-2.50 R4	2 ea.
80102	Flat Free Wheel - 8.5"-2.50 R4	2 ea.
80105	Pneumatic Hand Truck Wheel, 10.18"	2 ea.
80107	Flat Free Hand Truck Wheel, 10.18"	2 ea.
80109	Pneumatic Outdoor Hand Truck Wheel, 10.08"	2 ea.
80111	Flat Free Outdoor Hand Truck Wheel, 10.23"	2 ea.
80113	Pneumatic H.D. Hand Truck Wheel, 12.25"	2 ea.
80115	Flat Free H.D. Hand Truck Wheel, 13"	2 ea.
80116	Pneumatic Wheel Barrow Wheel, 15.08"	2 ea.
80118	Flat Free Wheel Barrow Wheel, 15.3"	2 ea.

STORAGE SOLUTIONS

Tilt Bins



- Easy multi-purpose storage solution.
- Functional design allows them to be stacked, screwed to a wall, or attached to a display unit.
- Sections interlock to form a rigid storage solution.
- Supplied with fastening screws and pegs.

PART#

DESCRIPTION

TF306	6 Compartments Tilt Bin (3 wide & 2 high)			
	WIDTH	DEPTH	HEIGHT	WEIGHT CAPACITY
	11-13/16"	3-5/8"	9"	15 kg
TF308	8 Compartments Tilt Bin (4 wide & 2 high)			
	WIDTH	DEPTH	HEIGHT	WEIGHT CAP.
	11-13/16"	2-1/2"	6-5/8"	15 kg
TF604	4 Compartments Tilt Bin (4 wide)			
	WIDTH	DEPTH	HEIGHT	WEIGHT CAP.
	23-5/8"	6-5/8"	8-3/16"	30 kg
TF605	5 Compartments Tilt Bin (5 wide)			
	WIDTH	DEPTH	HEIGHT	WEIGHT CAP.
	23-5/8"	5-1/4"	6-1/2"	20 kg

Wheel Merchandiser

PART#	CONTENTS
80100	1 Wheel Rack, 46" wide x 64" high x 24" deep
80100K	Wheels Merchandiser. Includes 44" x 12" Dynaline "Wheels" Sign and labels (80100L)

PART#	DESCRIPTION	QTY.
80101	Pneumatic Wheel - 10"-2.50 R4	2 ea.
80102	Flat Free Wheel - 10" -2.50 R4	3 ea.
80105	Pneumatic Hand Truck Wheel - 10" - 4.10/3.50 R4	2 ea.
80107	Flat Free Hand Truck Wheel - 10" - 4.10/3.50 R4	3 ea.
80109	Pneumatic Outdoor Hand Truck Wheel - 3.00 R4	2 ea.
80111	Flat Free Outdoor Hand Truck Wheel - 3.00 R4	3 ea.
80113	Pneumatic H.D. Hand Truck Wheel, 13x5 R6	2 ea.
80115	Flat Free H.D. Hand Truck Wheel, 13x5 R6	3 ea.
80116	Pneumatic Wheel Barrow Wheel, 4.80/4 R8	2 ea.
80118	Flat Free Wheel Barrow Wheel, 4.80/4 R8	2 ea.
80120	High Speed Trailer Wheel, 4.80 x 12	1 ea.
80124	High Speed Trailer Wheel, 5.30 x 12	2 ea.
80128	High Speed Trailer Wheel - ST205/75 D13	2 ea.
80130	High Speed Trailer Wheel - ST205/75 D14	1 ea.
80132	High Speed Trailer Wheel - ST205/75 D15	1 ea.



STORAGE SOLUTIONS

Dynaline Bin Box

PART#	DESCRIPTION
00007	A great way to organize small parts Corrugated cardboard box with dividers. Dimensions: 11-11/16"L x 4-7/8"W x 3-13/16"H



Storage Bins

Durable, open, stackable design as well as side by side.
Supplied with stacking pegs and labels.

PART#	LENGTH	WIDTH	HEIGHT	WEIGHT CAP.	CARTON QTY.
HB1218	7-1/16"	4-3/4"	3-5/16"	3 kg	60
HB1525	10"	5-7/8"	4-3/4"	6 kg	36
HB2035	13-3/4"	8-1/16"	5-7/8"	20 kg	16
HB2045	18-7/8"	7-7/8"	7"	30 kg	12
HB3045	18-7/8"	11-3/4"	7"	50 kg	12



DRIVER BIT DISPLAYS

Compact Driver Bit Display



#1 Acrylic Bit Display

Magnetic 1/4" to 1/2"
Robertson #1, #2, #3 from 2" to 6"
Socket Adapters

PART#	NO. PIECES	LENGTH	WIDTH	HEIGHT
77799	307	5"	7"	9"
100859		Display Only		

Standard Driver Bit Display



Acrylic Display with 2 Drawers for Additional Product.

Magnetic & Deep Nut Drives 1/4" to 1/2"
Robertson #1, #2, #3 from 1" to 12",
Phillips #1, #2, #3 from 1" to 6",
Socket Adapters

PART#	NO. PIECES	LENGTH	WIDTH	HEIGHT
77801	1,404	11"	16.25"	13"
100801		Display Only		

Automotive Driver Bit Display



Brushed Aluminum Display

Magnetic & Deep Nut Drives 1/4" to 1/2"
Robertson #1, #2, #3 from 1" to 6",
Phillips #1, #2, #3 from 2" to 6",
Specialty Bits, Magnetic Nut Drivers, Bit Holders
and Socket Adapters.

PART#	NO. PIECES	LENGTH	WIDTH	HEIGHT
77804	533	7.5"	12"	15.5"
100804		Display Only		

Carousel Driver Bit & Magnetic Nut Drive Display

Acrylic Display.

3 Configurations below.

PART#	DESCRIPTION	
77850	10 Pack Display - 50 mm Bits Holds up to 80, 10 packs & 144 of the 6" Robertson/ Phillips	
77851	10 Pack Display - 50 mm Bits & 5 Pack - 65 mm Mag Nuts Holds up to 68 pieces (28 Mag Nut 5 Packs & 40 Driver Bit 10 Packs)	
77852	5 Pack Display - 65 mm Mag Nuts Holds up to 56, 5 packs & 144 of the 6" Robertson/ Phillips	
LENGTH	WIDTH	HEIGHT
10"	10"	13"

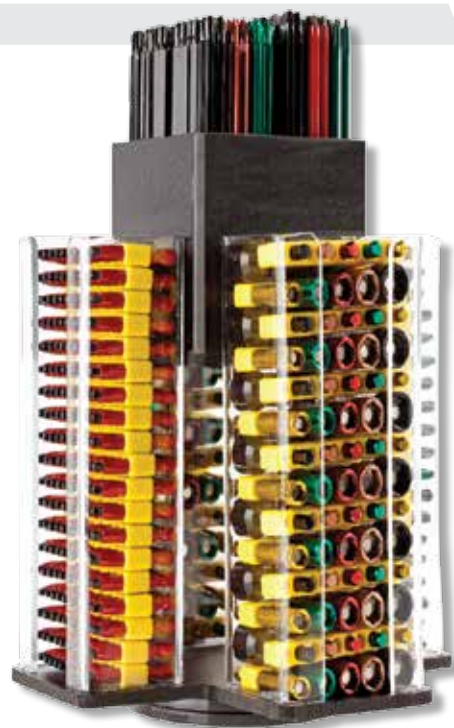

Customizable 5 & 10 Pack Program

- #1 Profit per square foot
- Works with both displays seen on this page
- Customizable 5 pack nut drives
- Customizable 10 pack bit sets
- Countertop point of purchase
- Each Pack UPC Labeled

Driver Bit Display

Brushed Aluminum Display

Single Sleeve

Counter Point of Purchase

Holds 20 - 10 Packs

PART#	DESCRIPTION	LENGTH	WIDTH	HEIGHT
100853	10 Pack Display	8"	10"	11"
100853	Display only			



Impact Driver Bit Display



Counter top point of purchase
Display holds up to 48 - 10 Packs

PART#	NO. PIECES	LENGTH	WIDTH	HEIGHT
77858	72	5"	6"	8.5"
100858	Display Only			

Jar Display



500 PIECES: 72122



12 PIECES: 204337

Impulse Items

Any type of driver bits, nut drivers, adapters, flashlights
Two sizes available

PART#	VOLUME	HOLDS
100900	250 ml	250 Driver bits
100901	500 ml	500 ml Driver bits

Driver Bit Display



Gravity fed counter top point of purchase
Compact design
Contractor's choice
Customizable kit tops

PART#	NO. PIECES	LENGTH	WIDTH	HEIGHT
100854	13	7"	8"	15.5"



YOUR LOGO HERE

Product customization helps build your brand and boost your sales.

See our Custom Printing & Products section.

3 Blade and Cutter Display

PART#	CONTENTS
100857	Display Only 7.5" x 12" x 15.5"
558601	3 Blade and Cutter Display. Includes 3 Types of Blades.

PART#	DESCRIPTION	QTY.
2555010	Samurai Blade Heavy Duty 3/4"	12
2555050	Samurai Blade Heavy Duty 3/4"	12
2554303	Serrated Blade Heavy Duty	12
Display Holds up to 100 Cutters (Not included)		



Blade and Cutter Display

PART#	CONTENTS
100890	Display Only 4.5" x 10.5 x 6.5"
558602	Blade and Cutter Display (Small). Includes Blades.

PART#	DESCRIPTION	QTY.
2555010	Samurai Blade Heavy Duty 3/4" (10 Packs)	12
2555050	Samurai Blade Heavy Duty 3/4" (50 Packs)	6
Display Holds up to 50 Cutters (Not Included)		



Counter Top Blade Display

PART#	CONTENTS
100803	Display Only 8" x 8.5" x 7"
2555000	Counter Top Blade Display. Includes Blades.

PART#	DESCRIPTION	QTY.
2555010	Samurai Blade Heavy Duty 3/4" 10/pack	12
2555050	Samurai Blade Heavy Duty 3/4" 50/pack	12
2554303	Serrated Blade Heavy Duty 5/pack	12



Magnifier Display



PART#	CONTENTS
2808200	Magnifier Display Includes 2808201 and products listed below 10" x 7.5" x 9"

PART NO.	DESCRIPTION	QUANTITY
808250	4.5X Lens 50 mm	4
808775	3X Lens 75 mm	4
808290	2.5X Lens 90 mm	4
808345	2.5X Lens 110 mm	4
2808201	Display Only	1

* Part # 280XXXXX = Packaged Products
Part # 80XXXXX = Bulk Products

Carpenter Pencil Display



PART#	CONTENTS
100807	Pencil Display 7" x 19" x 6" (Display Only)
33670	Carpenter Pencil Display. Includes 420 Pieces.

PART#	DESCRIPTION	QTY.
33801	12mm Carpenter Pencil FL.Red	144
33880	12mm Soft Carpenter Pencil FL.Orange	72
33890	12mm Hard Carpenter Pencil FL.Green	72
33900	12mm Red/Black Carpenter Pencil	72
100807	PENCIL Display	1
33788	Pro Carpenter Pencil - Sharpener	36
33670	Carpenter Pencil Holders	24

Drill Bit Display

PART#	CONTENTS
100811	Drill Bit Display Only. 27" x 18.5" x 17"
77890	Drill Bit Display. Includes 174 Pieces.

PART NO.	DESCRIPTION	QUANTITY
851000	1/16" Grizzly Drill Bit 2/pack	6 ea.
851002	5/64" Grizzly Drill Bit 2/pack	6 ea.
851004	3/32" Grizzly Drill Bit 2/pack	6 ea.
851006	7/64" Grizzly Drill Bit 2/pack	6 ea.
851008	1/8" Grizzly Drill Bit 2/pack	6 ea.
851010	9/64" Grizzly Drill Bit	6 ea.
851012	5/32" Grizzly Drill Bit	6 ea.
851014	11/64" Grizzly Drill Bit	6 ea.
851016	3/16" Grizzly Drill Bit	6 ea.
851018	13/64" Grizzly Drill Bit	6 ea.
851020	7/32" Grizzly Drill Bit	6 ea.
851022	15/64" Grizzly Drill Bit	6 ea.
851024	1/4" Grizzly Drill Bit	6 ea.
851026	17/64" Grizzly Drill Bit	6 ea.
851028	9/32" Grizzly Drill Bit	6 ea.
851030	19/64" Grizzly Drill Bit	6 ea.
851032	5/16" Grizzly Drill Bit	6 ea.
851034	21/64" Grizzly Drill Bit	6 ea.
851036	11/32" Grizzly Drill Bit	6 ea.
851038	23/64" Grizzly Drill Bit	6 ea.
851040	3/8" Grizzly Drill Bit	6 ea.
851042	25/64" Grizzly Drill Bit	6 ea.
851044	13/32" Grizzly Drill Bit	6 ea.
851046	27/64" Grizzly Drill Bit	6 ea.
851048	7/16" Grizzly Drill Bit	6 ea.
851050	29/64" Grizzly Drill Bit	6 ea.
851052	15/32" Grizzly Drill Bit	6 ea.
851054	31/64" Grizzly Drill Bit	6 ea.
851056	1/2" Grizzly Drill Bit	6 ea.



Dynaline Custom Banner

PART#	CONTENTS
Call us!	Custom Print Mounted on Core Plast - up to 4' tall



BOSS Branded End Cap Display



The BOSS standing floor merchandiser is the ideal marketing tool for distributors requiring a wide range of sizes and a strong visual presence.

This merchandiser is shipped with simple and easy to follow assembly instructions.

No tools are required. You'll be ready to sell BOSS's range of tools, knives, blades, lights, locks and kits within 15 minutes.

This merchandiser features;

- Strong visual presence
- Informative header card
- Holds a large range of stock
- Boss racks feature moveable hooks for simple customization
- Handy shelf for displaying kits and other items that don't hang sell.
- Heavy duty steel construction
- Simple to assemble
- Adjustable levelling feet

Comes in three separate configurations. 2, 4, & 6 quantities

The unit comes with top signage that can be customized for height, if required.

Signage holder top measures 77 1/2" from floor

Sign top (shown) measures 85 1/4" from floor

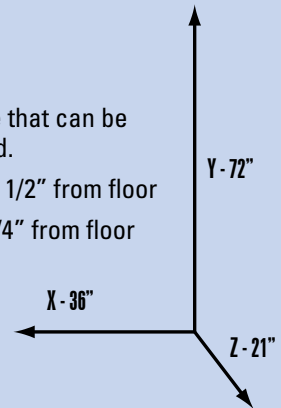

Continued Next Page

BOSS Branded End Cap Display

PART#	CONTENTS
100805	BOSS End Cap Includes 100805 and products listed below 72" tall x 36" wide x 24" deep Signage (Adds addition 13" to height)

100805B Automotive Build - 484 pieces

PART#	CONTENTS
100805B	BOSS End Cap Includes 100805 and products listed below Includes 4 of products listed

PART NO.	DESCRIPTION	QUANTITY
2554405	Blade Utility 2 notch 10/pk	12
2554003	ECONOMY BLADE 10/TUBE	4
2554033	Economy Heavy Duty Blade 50/pk	4
2554403	Blade Heavy Duty 3/4" 10/pk	4
2554433	Blade Heavy Duty 3/4" 50/pk	4
2554305	Serrated Utility Blade 10/pk	4
2554303	Serrated Blade Heavy Duty 5/pk	4
2554333	Serrated Blade Heavy Duty 45/pk	4
2555110	Samuri Blade Standard Duty 3/8" 10/pk	4
2555010	Samuri Blade Heavy Duty 3/4" 10/pk	4
2555050	Samuri Blade Heavy Duty 3/4" 50/pk	4
2555403	Samuri Mega Blade 1" 5/pk	4
2554407	Safety Blade Utility 10/pk	4
2554402	HOOK BLADE 10PC	4
568687	Ergo Auto Lock RED Carded	4
568688	Ergo Knob Lock YELLOW Carded	4
2562600	Ergo KL Cutter with Serrated Blade	4
556750	Comfort Grip 3/4" Cutter Knob Lock Carded	4
556760	Comfort Grip 3/4" Cutter Auto Lock Carded	4
556900	Mega Cutter 1" Knob Lock Carded	4
556920	Mega Cutter 1" Auto Lock Carded	4
2560430	6 Blade Auto Load 3/4" Knob Lock	4
550470	18mm 5 Blade Auto Load Cutter Silver w/ Sheath Lock Bulk	4
550480	25mm 5 Blade Auto Load MEGA Cutter Carded	4
559110	RAZOR FOLDING KNIFE W/ 5 PK	4
2560406	6 Blade Auto Load 3/8" Auto Lock	4

100805A Building Supply Build - 667 pieces

PART#	CONTENTS
100805A	BOSS End Cap Includes 100805 and products listed below Includes 6 of products listed

100805A Small Set Up - 167 pieces

PART#	CONTENTS
100805C	BOSS End Cap Includes 100805 and products listed below Includes 2 of products listed

PART NO.	DESCRIPTION	QUANTITY
550460	Safety Cutter Comfort Grip	4
771410	DAMAGED SCREW REMOVER 3 PACK	4
771500	9PC ALLAN SET IMPERIAL S2 PRO CARDED	4
231333	Mechanics LED Single Diode 3 x AAAA	4
771395	33 PC SECURITY SET INDUSTRIAL QUALITY-S2 STEEL	4
793520	3 Pac 1/4" Hex Shank Socket Adaptor Set	4
774440	16PC Driver/Socket Set w/ Ratchet	4
234440	8 LED with LASER Pointer 3 x AAA	4
B54135	JAB SAW TEFLON WITH HOLSTER	4
B54124	DRYWALL SAW, TEFLON, DBLE SIDE BLADE	4
33105	9" LEVEL, CAR. PENCIL W/ SHARPENER PKG	4
234439	3 WATT 3 x AAA SUPER BRITE CREE LED	4
2251530	Brass Padlock 30x20mm	4
2251531	K30-1 KA Brass PL.30x20mm 2/pk	4
2251540	Brass Padlock 40x23mm	4
2251541	K40-1 KA Brass PL 40x23mm 2/pk	4
2251550	Brass Padlock 50x30mm	4
2251551	K50-1 KA Brass PL 50x30mm 2/pk	4
2251850	Brass Padlock 50x75mm	4
2251851	K50-1 KA Brass PL 50x75mm 2/pk	4
2253554	Combination Padlock	4
2558228	Printed Red Econo cutter	240
38450	25' x 1.25" SAE TAPE M. NYLON COAT SAE 25"	48
2560200	Cutter Stainless Steel	4



DYNALINE

Better products for all.

Drain Pans

Funnels

Grease Fittings

**Grease Dispensers
& Adapters**

Lever Grease Guns

Measurers

O-Rings

Oilers

Pistol Grip

Grease Guns

Pumps

**Rechargeable
Grease Gun Kits**

Siphon Pumps

Suction Gun

Used Fluid Drainer



LUBRICATION

Rechargeable Grease Gun Kits

Rechargeable Grease Gun Kits 1

Rechargeable Grease Gun Parts 2

Lever Grease Guns

Standard & Heavy Duty 3

Pistol Grip Grease Guns

Mini, Regular & Heavy Duty 4

Suction Gun

Suction Gun 5

Pumps (Multi-Purpose)

Siphon & Self Priming 5

Lever Action, Rotary & Portable 6

Diaphragm Fuel Pump 7

Used Fluid Drainer

Used Fluid Drainer 7

360° Swivel Grease Coupler

360° Swivel Grease Coupler 8

Grease Dispensers & Adapters

Needle Nose Dispenser & Adapter 8

Grease Gun Holder 8

Grease Injectors, Couplers & Adapters 9

Filler Nipple 9

Grease Gun Pipes & Hoses 10

O-Rings

S.A.E. O-Rings 11 - 14

Metric O-Rings 15

High Pressure O-Rings 16

Grease Fittings

Metric, Drive in, & S.A.E. (Zerks) 18

Oilers

Pump Oilers and Oilers with Base 19

Funnels

Multi-Purpose, Sets, & Industrial 20

Auto, Anti-Splash, Flex, & Foldable 21

Dirt Free, & Heavy Duty 22

Tin & Tractor 24

Transmission, & Offset 24

Easy Flow 25

Measurer

Fixed Lids & Nozzles 23

Portable 23

Scoops 23

Automatic Battery Filler 23

Drain Pans

Standard, Sealable, & Truck/ Trailer 25

IMPORTANT!

Special note for new grease guns that have never been used or loaded: The most frequent grease gun problem is air being trapped in the pump. It is necessary to get as much air out of the system as possible when loading the gun for the first time. Take the plastic cap (not the metal pull tab) off the new cartridge and pack the cavity at the pump end with as much grease as possible using a plastic spoon. This will prime the pump and prevent air from being trapped in the pump. The left over grease will usually take care of this step after the initial use.

Note spéciale pour les nouveaux pistolets à graisse qui n'ont jamais été utilisés ou chargés: Le problème du pistolet à graisse la plus fréquente est l'air est emprisonné dans la pompe. Il est nécessaire de se débarrasser de l'air dans le pistolet lors du chargement du pistolet pour la première fois. Enlevez le capuchon en plastique (pas la tirette de métal) de la nouvelle cartouche et remplissez la cavité à la fin du pistolet avec le maximum de graisse que possible en utilisant une cuillère en plastique. Cela devrait amorcer le pistolet et empêcher l'air d'être piégé dans la pompe. La graisse qui reste généralement prend soin de cette étape après la première utilisation.

RECHARGEABLE GREASE GUN KITS

Professional-grade, heavy-duty cordless grease guns that lets you do your lubrication tasks in half the time of a manual grease gun, with much less worker fatigue. Featuring a high-torque motor combined with a high-capacity NiCd battery for superior performance and run time.

Rechargeable Grease Gun Kit - 19.2V

Heavy duty. Ideal for Ag Implements, Tractors, Construction, Industrial, Machinery, Automotive or anywhere high volume, portable greasing is required. Comes with two 19.2 V heavy duty NiCd batteries and 19.2V 1 Hour Quick Charger. Ergonomically balanced. 42" heavy duty flexible hose with bend restrictors for added life and durability.

Each kit contains:

- Powered Grease Gun Handle Assembly
- Two 19.2 Volt Heavy Duty NiCd Batteries
- 19.2 Volt 1-Hour Quick Charger
- 42" Heavy Duty Flexible Hose
- Grease Assembly Tube
- Heavy duty, high impact molded plastic carrying case
- 14.5 oz. capacity.

PART#	VOLTAGE	MAX. OPERATING PRESSURE	CARTRIDGES PER CHARGE	GREASE OUTPUT @ 1000 PSI
11025	19.2 Volt	8,500 psi	3	3 oz./Minute

**Rechargeable Grease Gun Kits**

Speeds routine lubrication tasks and relieves worker fatigue. Three-way loading-bulk, cartridge and filler pump. Fast charger requires 2 hours charging time.

Each kit contains:

- Powered Grease Gun Handle Assembly
- 2 Batteries
- Battery Charger
- Flexible Hose - 30" L, with coupler & pressure relief valve
- Warming Blanket
- Heavy duty, high impact molded plastic carrying case

PART#	VOLTAGE	MAX. OPERATING PRESSURE	CARTRIDGES PER CHARGE	GREASE OUTPUT @ 1000 PSI
11030	14.4 Volt	7,500 psi	5	3 oz./Minute
11040	18 Volt	8,000 psi	5-6	3.2 oz./Minute
11060	12 Volt	6,500 psi	3-4	2.6 oz./Minute





RECHARGEABLE GREASE GUN KIT REPLACEMENT PARTS

Professional-grade, heavy-duty cordless grease gun replacement parts.

Replacement Grease Hoses

PART#	FEATURES
11024	Specifically designed for replacing 11025 hose. 42" long.
11054	Fits Rechargeable Grease Guns 11030, 11040 and 11060. 30" long.

Replacement Batteries

PART#	FEATURES
11021	Suitable for 11025, Rechargeable NiCd. 19.2VDC, 1500 mAh
11041	Suitable for 11040, Rechargeable NiCd. 18VDC, 1300 mAh
11061	Suitable for 11060, Rechargeable NiCd. 12VDC, 1700 mAh

Replacement Chargers

PART#	FEATURES
11023	Suitable for 11025 Rechargeable Grease Guns. 120V/60HZ input 19.2VDC , 1.3A, 1 hour quick charge, UL/ULC approved.
11043	Suitable for 11030, 11040 and 11060 Rechargeable Grease Guns. Class 2 power unit. 120V/60Hz input 18VDC, 2300 mA output, 2 hours fast charge, UL/CSA Approved.

CHARGING THE BATTERY PACK ON RECHARGEABLE BATTERIES

Before using your Rechargeable Grease Gun for the first time, the NiCad battery pack should be charged for a minimum of 1.5 hours. If the battery pack is already installed in the Rechargeable Grease Gun, remove it by following the instructions under INSTALLING or REMOVING BATTERY PACK in the user manual. As the battery pack approaches the discharged state, you will notice a sharp drop in tool performance. When the tool is unable to perform the task at hand, it is time to recharge the battery pack. **Recharging the NiCad battery pack before this condition is reached will reduce the total work life of the pack.** Discharging the pack beyond this point can damage the pack. NOTE: Battery temperature will increase during and shortly after use. Batteries may not accept a full charge if they are charged immediately after use. Allow the battery pack to cool to room temperature before charging for best results.



Multi-Purpose Lithium Grease

An excellent multi-purpose extreme pressure grease for ball joints, steering knuckles, chassis, etc. Very good sealing properties to keep water & dirt out. (Formula EP-2)

PART#	FEATURES	QTY.
11073	3 oz. (85g) grease tubes. Clamshell package.	Pkg. of 3
11070	14 oz. (400g) grease tube	Case of 10

LEVER GREASE GUNS

The lever action design of our heavy duty grease guns facilitate accurate control of grease flow. Fitted with a 6" steel curved extension pipe and coupler, these grease guns provide easy access to lubrication points in cars, trucks, tractors and heavy machinery. These grease guns can be loaded with 14 oz. cartridges, through a dispenser or bulk loaded.

11082C - Premium Heavy Duty Grease Gun

- Premium Heavy duty model with cast iron pump head.
- Variable stroke mechanism.
- Knurled barrel for a non-slip grip.
- Uses standard 14 oz. grease cartridges or can be bulk filled.
- Plunger stop holds follower rod firmly in place for easy cartridge replacement.
- Includes a 6" steel curved extension pipe and coupler.
- Working pressure: 4,500 psi, develops up to 10,000 psi.



11083 - Standard Duty Grease Gun

- Standard duty with die cast head.
- Knurled barrel for a non-slip grip.
- Uses standard 14 oz. grease cartridges or can be bulk filled.
- Includes a 6" steel curved extension pipe and coupler.
- Plunger stop holds follower rod firmly in place for easy cartridge replacement.
- Working pressure: 4,500 psi, develops up to 10,000 psi.



11085A - Heavy Duty Grease Gun

- Heavy duty with die cast pump head.
- Variable stroke feature.
- Vinyl grip handle.
- Knurled barrel for a non-slip grip.
- Uses standard 14 oz. grease cartridges or can be bulk filled.
- Plunger stop holds follower rod firmly in place for easy cartridge replacement.
- Includes a 6" steel curved extension pipe and coupler.
- Working pressure: 4,500 psi, develops up to 10,000 psi.





PISTOL GRIP GREASE GUNS

11066 - Pistol Grip Grease Gun

- Premium Heavy duty model.
- Die cast pump heads for strength and durability.
- Knurled barrel for a non-slip grip.
- Convenient one hand operation.
- Uses standard 14 oz. grease cartridges or can be bulk filled.
- Working pressure: 4,500 psi, develops up to 7500 psi.
- Locking plunger mechanism holds follower rod firmly in place for easy cartridge replacement.
- Includes 16" flexible hose, coupler and air release valve.
- Variable stroke feature.
- Repair kit available - **Part# 11066-1**



Includes: 18" Hose, Grease Coupler, and Steel Extension

11084A - Pistol Grip Grease Gun

- Die cast pump heads for strength and durability.
- Knurled barrel for a non-slip grip.
- Convenient one hand operation.
- Uses standard 14 oz. grease cartridges or can be bulk filled.
- Working pressure: 4,500 psi, develops up to 7,300 psi.
- Locking plunger mechanism holds follower rod firmly in place for easy cartridge replacement.
- Includes 18" flexible hose, 5" steel extension and grease coupler
- 0.7grams/Pump



11087A - Pistol Grip Grease Gun

- Die cast pump heads for strength and durability.
- Knurled barrel for a non-slip grip.
- Convenient one hand operation.
- Uses standard 14 oz. grease cartridges or can be bulk filled.
- Working pressure: 4,500 psi, develops up to 7,300 psi.
- Locking plunger mechanism holds follower rod firmly in place for easy cartridge replacement.
- Includes 5" steel extension and grease coupler.
- 0.7grams/Pump



11089A - Mini Pistol Grip Grease Gun

- Die cast pump head for strength and durability.
- Knurled barrel for a non-slip grip.
- Convenient one handed operation
- Uses standard 3 oz. grease cartridges or can be bulk filled.
- Working pressure: 2000psi, develops up to 4,000 psi.
- Thumb release catch holds follower rod firmly in place for easy cartridge replacement.
- Includes a 5" steel extension and grease coupler.

11090A - Suction Gun

- Robust design for easy draining and filling.
- Capacity: 17 oz. (500 cc)
- Complete with 12" vinyl hose for transmission and differential service
- Powder coated blue paint.
- Precision follower provides superior suction for light grease, water and oil.

**11093 - Fluid Transfer Pump**

- Designed for the direct transfer of gasoline, oil and other non-corrosive fluids from one container to another.
- Capacity: 18 oz. (532 ml)
- Rugged construction.
- Supplied with two 48" clear PVC hoses.

**11094 - Siphon Hose Pump**

- Includes 2 hoses (35" each)
- Made of durable plastic and rubber
- Suitable for transferring liquids, gasoline resistant

**11095 - Self Priming Copper Pump**

- Glass ball, stainless steel spring and 6' of ethanol resistant hose
- 1/2" high quality copper pump

**11096 - Multi-Use Siphon Pump**

- Includes 2 red siphon hoses (4' & 1/4" each) with 2 connectors & 1 adaptor
- 1 air pressure hose (15-1/2" long) with 2 piece adaptor.
- 1 dipstick tube (47" long)
- 1 liquid/ air pump & siphon





11092A - Lever Action Barrel Pump

Specially designed for the fast transfer of lubricants, solvents, agricultural and industrial chemicals, additives and other non-corrosive liquids from 15 to 55 gallon drums with 2" bung openings.

- Heavy Duty hand operated lever action dispenses approximately 3/4 pint (350 ml) per stroke.
- Equipped with brass rings, self-adjusting telescopic suction tube.
- 2" size bung nut and cushioned vinyl handle tube
- Outlet threaded for standard male garden hose connector or supplied curved spout.
- Zinc-plated corrosion resistant finish.



11091 - Lever Action Pail Pump

- For transmission fluid and heavier oils (max. 140 wt.).
- Fits 5 gallon (20 litre) pails.
- Includes drum cover, 48" delivery hose, 46" usable hose length.
- 1L per 12 strokes, 2 oz. per stroke.



11094A - Rotary Barrel Pump

- 1" NPT inlet, 1" O.D. discharge spout.
- Heavy duty cast iron construction.
- Smooth easy action.
- 2" NPT threaded bung adapter.
- 3 sections of 1" x 12" suction pipe included
- Compatible with: Diesel, kerosene, machine oil, fuel oil, agricultural fluids, detergents, lube oil, noncorrosive petroleum products
- Delivers 1 gallon per 18 strokes.
- Fits 30 gallon to 55 gallon barrels.



11097 - Portable Fluid Pump

- For transmission fluid and heavier oils.
- Enamel painted finish. Rugged construction.
- Supplied with durable polycarbonate wheels and dispenser hose
- Hand operated pump.
- 5 gallon capacity drum.
- 2 oz. per stroke.
- 3/4" outside hose diameter.
- 1/2" inside hose diameter.
- 73" hose length

11800 - Diaphragm Fuel Pump

Fast, dual action. Double acting design delivers liquid on both in and out strokes. Recommended for gasoline and diesel fuel.

Quickly dispenses gasoline, diesel fuel and light petroleum products.

- 2" bung adapter and manual nozzle (L30-90N).
- 22" to 39" telescoping suction tube with foot valve (L30-99N).
- Fits 15 to 55 gallon drum 8' hose with static wire (L30-95N).
- Dispenses 1 gallon per 8 strokes.
- Lockable handle.
- Airtight valves.
- Heavy duty diaphragm, large action surface.



11802 - Used Fluid Drainer

Portable, special hose design for faster fluid transfer at any height. Height adjusts from 47-3/4" to 75-3/16" for draining fluids on vehicle lifts. Rugged steel construction.

- Tank capacity: 18 gallons (68.1L).
- Drain bowl capacity: 2.1 gallons (11.4L).
- Heavy duty 13-15/16" diameter drainage funnel with filter screen.
- 2.5 meters long evacuation hose with 1/4" - 18 NPT air coupler.
- Includes regulator and gauge.
- Two large 6" wheels and two 3" swivel casters.
- Working pressure: 10 PSI.
- Gauge: 0-23 PSI in 1/2 PSI increments.
- Drain Hose: 105" long x 1" diameter



Parts For Used Fluid Drainer (Part# 11802)

PART#	DESCRIPTION	PART#	DESCRIPTION
11802-8	Caster Kit	11802-4	Bowl Kits
11802-7	Wheel Kit	11802-3	Bowl & Ext. Tube Kit
11802-6	Regulator Kit	11802-2	Drain Hose Kit
11802-5	Locking Knob Kit	11802-1	Handle Kit





11071A - 360° Swivel Grease Coupler

- Swivels in full 360° circle & locks at any 45° position.
- Specifically designed for vehicles & equipment with hard-to-reach fittings.
- 1/8" NPT female inlet, 7,000 psi.
- 1 pc. in clamshell package.



11072 - Grease Accessory Kit

11 piece set in a blow case with instruction manual and color sleeve.

- 12" heavy duty extension hose.
- 1/8" NPT, 4,500 PSI working pressure.
- 1/8" NPT 360° swivel.
- 3 jaw heavy duty grease coupler.
- 4 jaw heavy duty grease coupler.
- 90° grease coupler adapter.
- Grease injection needle.
- 4" needle nozzle.
- Seal-off dispenser.
- Grease gun bracket.
- Needle tip adapter.
- Professional narrow needle nose dispenser.



11075A

11080A

Needle Nose Dispensers

Universal joints, tough to reach areas, 1/8" threads.

PART#	FEATURES	OVERALL LENGTH
11075A	1-1/2" Needle Nose Dispenser. 1 pc. in clamshell package.	2-3/4"
11080A	For dispensing a fine line of grease. 1 pc. in clamshell package.	1-1/2"



Needle Nose Adapter

PART#	FEATURES	OVERALL LENGTH
11076	4" long. For hard-to-reach grease points. Supplied with locking sleeve to fit all grease couplers. In clamshell package.	7-1/4"



Grease Gun Holder

PART#	FEATURES
11077	Holds grease guns and suction guns with 2-1/4" diameter barrel. Easily mounts on most surfaces.

Grease Injectors

For sealed bearings and joints. Supplied in a blister package.

PART#	FEATURES	QTY. PER PKG.
11122	18 gauge x 1-1/2" long.	3
11123A	18 gauge x 1-1/2" long.	1
11124A	18 gauge and 21 gauge, 1-1/2" long	2



Seal Off Adapter

Allows lubricating without fitting; rubber tip forms seal.

PART#	FEATURES
11139	Rubber tipped nozzle for hand operated grease guns. Use with grease plugs (1/8" NPT female). 1 piece polybag.
11139A	Rubber tipped nozzle for hand operated grease guns. Use with grease plugs (1/8" NPT female). 1 piece in clamshell package.



11139A

90° Grease Coupler

PART#	FEATURES
11081A	Can be used where space is a problem or as a general purpose grease coupler. Fits all standard grease guns. 1 piece in clamshell package.



Grease Couplers

With ballcheck and hex nut on body end. Fits over grease fittings.

PART#	FEATURES	QTY. PER PKG.
11121	6,000 psi. 1/8" NPT Coupler. For light to medium duty applications.	10
11121A	6,000 psi. 1/8" NPT Coupler. For light to medium duty applications.	1 (Dynapak)
11125	10,000 psi. 1/8" NPT Coupler. For heavy duty applications.	5
11125A	10,000 psi. 1/8" NPT Coupler. For heavy duty applications.	1 (Dynapak)



11121



11125

Grease Filler Nipple

Fits into Grease Gun heads.

PART#	FEATURES	QTY. PER PKG.
11079A	Grease filler nipple, in Dynapak.	1 ea.





Grease Gun Pipe

For manual grease guns only.

PART#	LENGTH	ENDS	SAFE WORKING PRESSURE	PACKAGE TYPE
11078	5-1/2"	1/8" NPT	6,000 PSI	Polybag

Grease Hoses

Reinforced thermoplastic cover with nylon braid:

PART#	LENGTH	ENDS	SAFE WORKING PRESSURE	WORKING TEMPERATURE	PACKAGE TYPE
11140	12"	1/8" NPT	4,500 PSI	-40°C to 95°C	Retail pkg.
11141	18"	1/8" NPT	4,500 PSI	-40°C to 95°C	Retail pkg.

Reinforced rubber cover with steel wire braid:

PART#	LENGTH	ENDS	SAFE WORKING PRESSURE	WORKING TEMPERATURE	PACKAGE TYPE
11144	24"	1/8" NPT	3,600 PSI	-40°C to 95°C	Bulk with UPC label
11142A	12"	1/8" NPT	3,600 PSI	-40°C to 95°C	Retail pkg
11143A	18"	1/8" NPT	3,600 PSI	-40°C to 95°C	Retail pkg

Reinforced rubber cover with steel wire braid (in display box):

Working temperature: -40° to 95°C. Each grease hose is individually UPC barcode labelled inside a full colour display box.

PART#	LENGTH	ENDS	SAFE WORKING PRESSURE	WORKING TEMPERATURE	PACKAGE TYPE
11142	12"	1/8" NPT	3,600 PSI	-40°C to 95°C	10/ Package
11143	18"	1/8" NPT	3,600 PSI	-40°C to 95°C	10/ Package

WARNING!

Exceeding the S.W.P. (Safe Working Pressure) may result in personal injury.

S.A.E. O-rings

Used for petroleum based fuel/oil, water, alcohol, some acids and bases.
 Temperature range -55oC to 120oC. Buna N-70R Nitrile Durometer A.
 Conforms to ASTM D2000 M2BF714, B14, EA14, EF11, EF21, E014 & E034.

PART#	INDUSTRY NUMBER	THICKNESS	INSIDE DIAMETER	OUTSIDE DIAMETER	QTY PER PKG.
54006	6	1/16"	1/8"	1/4"	Pkg. of 15
54007	7	1/16"	5/32"	9/32"	Pkg. of 15
54008	8	1/16"	3/16"	5/16"	Pkg. of 15
54009	9	1/16"	7/32"	11/32"	Pkg. of 15
54010	10	1/16"	1/4"	3/8"	Pkg. of 15
54011	11	1/16"	5/16"	7/16"	Pkg. of 15
54012	12	1/16"	3/8"	1/2"	Pkg. of 15
54013	13	1/16"	7/16"	9/16"	Pkg. of 10
54014	14	1/16"	1/2"	5/8"	Pkg. of 10
54015	15	1/16"	9/16"	11/16"	Pkg. of 10
54016	16	1/16"	5/8"	3/4"	Pkg. of 10
54017	17	1/16"	11/16"	13/16"	Pkg. of 10
54018	18	1/16"	3/4"	7/8"	Pkg. of 10
54019	19	1/16"	13/16"	15/16"	Pkg. of 10
54020	20	1/16"	7/8"	1"	Pkg. of 10
54021	21	1/16"	15/16"	1-1/16"	Pkg. of 10
54022	22	1/16"	1"	1-1/8"	Pkg. of 10
54023	23	1/16"	1-1/16"	1-3/16"	Pkg. of 10
54024	24	1/16"	1-1/8"	1-1/4"	Pkg. of 10
54025	25	1/16"	1-3/16"	1-5/16"	Pkg. of 10
54026	26	1/16"	1-1/4"	1-3/8"	Pkg. of 10
54027	27	1/16"	1-5/16"	1-7/16"	Pkg. of 10
54028	28	1/16"	1-3/8"	1-1/2"	Pkg. of 10
54110	110	3/32"	3/8"	9/16"	Pkg. of 15
54111	111	3/32"	7/16"	5/8"	Pkg. of 15
54112	112	3/32"	1/2"	11/16"	Pkg. of 15
54113	113	3/32"	9/16"	3/4"	Pkg. of 15
54114	114	3/32"	5/8"	13/16"	Pkg. of 15
54115	115	3/32"	11/16"	7/8"	Pkg. of 15
54116	116	3/32"	3/4"	15/16"	Pkg. of 15
54117	117	3/32"	13/16"	1"	Pkg. of 10
54118	118	3/32"	7/8"	1-1/16"	Pkg. of 10
54119	119	3/32"	15/16"	1-1/8"	Pkg. of 10
54120	120	3/32"	1"	1-3/16"	Pkg. of 10
54121	121	3/32"	1-1/16"	1-1/4"	Pkg. of 10
54122	122	3/32"	1-1/8"	1-5/16"	Pkg. of 10
54123	123	3/32"	1-3/16"	1-3/8"	Pkg. of 10
54124	124	3/32"	1-1/4"	1-7/16"	Pkg. of 10
54125	125	3/32"	1-5/16"	1-1/2"	Pkg. of 10
54126	126	3/32"	1-3/8"	1-9/16"	Pkg. of 10
54127	127	3/32"	1-7/16"	1-5/8"	Pkg. of 10





S.A.E. O-RINGS

Used for petroleum based fuel/oil, water, alcohol, some acids and bases.
 Temperature range -55oC to 120oC. Buna N-70R Nitrile Durometer A.
 Conforms to ASTM D2000 M2BF714, B14, EA14, EF11, EF21, E014 & E034.

PART#	INDUSTRY NUMBER	THICKNESS	INSIDE DIAMETER	OUTSIDE DIAMETER	QTY PER PKG.
54128	128	3/32"	1-1/2"	1-11/16"	Pkg. of 10
54129	129	3/32"	1-9/16"	1-3/4"	Pkg. of 10
54130	130	3/32"	1-5/8"	1-13/16"	Pkg. of 10
54131	131	3/32"	1-11/16"	1-7/8"	Pkg. of 10
54132	132	3/32"	1-3/4"	1-15/16"	Pkg. of 10
54133	133	3/32"	1-13/16"	2"	Pkg. of 10
54134	134	3/32"	1- 7/8"	2-1/16"	Pkg. of 10
54135	135	3/32"	1-15/16"	2-1/8"	Pkg. of 10
54136	136	3/32"	2"	2-3/16"	Pkg. of 10
54137	137	3/32"	2-1/16"	2-1/4"	Pkg. of 10
54138	138	3/32"	2-1/8"	2-5/16"	Pkg. of 10
54139	139	3/32"	2-3/16"	2-3/8"	Pkg. of 10
54140	140	3/32"	2-1/4"	2-7/16"	Pkg. of 10
54141	141	3/32"	2-5/16"	2-1/2"	Pkg. of 10
54142	142	3/32"	2-3/8"	2-9/16"	Pkg. of 10
54143	143	3/32"	2-7/16"	2-5/8"	Pkg. of 10
54144	144	3/32"	2-1/2"	2-11/16"	Pkg. of 10
54145	145	3/32"	2-9/16"	2-3/4"	Pkg. of 10
54146	146	3/32"	2-5/8"	2-13/16"	Pkg. of 10
54147	147	3/32"	2-11/16"	2-7/8"	Pkg. of 10
54148	148	3/32"	2-3/4"	2-15/16"	Pkg. of 10
54149	149	3/32"	2-13/16"	3"	Pkg. of 10
54210	210	1/8"	3/4"	1"	Pkg. of 10
54211	211	1/8"	13/16"	1-1/16"	Pkg. of 10
54212	212	1/8"	7/8"	1-1/8"	Pkg. of 10
54213	213	1/8"	15/16"	1-3/16"	Pkg. of 10
54214	214	1/8"	1"	1-1/4"	Pkg. of 10
54215	215	1/8"	1-1/16"	1-5/16"	Pkg. of 10
54216	216	1/8"	1-1/8"	1-3/8"	Pkg. of 10
54217	217	1/8"	1-3/16"	1-7/16"	Pkg. of 10
54218	218	1/8"	1-1/4"	1-1/2"	Pkg. of 10
54219	219	1/8"	1-5/16"	1-9/16"	Pkg. of 10
54220	220	1/8"	1-3/8"	1-5/8"	Pkg. of 10
54221	221	1/8"	1-7/16"	1-11/16"	Pkg. of 10
54222	222	1/8"	1-1/2"	1-3/4"	Pkg. of 10
54223	223	1/8"	1-5/8"	1-7/8"	Pkg. of 10
54224	224	1/8"	1-3/4"	2"	Pkg. of 10
54225	225	1/8"	1-7/8"	2-1/8"	Pkg. of 10
54226	226	1/8"	2"	2-1/4"	Pkg. of 10
54227	227	1/8"	2-1/8"	2-3/8"	Pkg. of 10
54228	228	1/8"	2-1/4"	2-1/2"	Pkg. of 10

S.A.E. O-rings

Used for petroleum based fuel/oil, water, alcohol, some acids and bases.
 Temperature range -55oC to 120oC. Buna N-70R Nitrile Durometer A.
 Conforms to ASTM D2000 M2BF714, B14, EA14, EF11, EF21, E014 & E034.

PART#	INDUSTRY NUMBER	THICKNESS	INSIDE DIAMETER	OUTSIDE DIAMETER	QTY PER PKG.
54229	229	1/8"	2-3/8"	2-5/8"	Pkg. of 10
54230	230	1/8"	2-1/2"	2-3/4"	Pkg. of 10
54231	231	1/8"	2-5/8"	2-7/8"	Pkg. of 10
54232	232	1/8"	2-3/4"	3"	Pkg. of 10
54233	233	1/8"	2-7/8"	3-1/8"	Pkg. of 10
54234	234	1/8"	3"	3-1/4"	Pkg. of 10
54235	235	1/8"	3-1/8"	3-3/8"	Pkg. of 10
54236	236	1/8"	3-1/4"	3-1/2"	Pkg. of 10
54237	237	1/8"	3-3/8"	3-5/8"	Pkg. of 10
54238	238	1/8"	3-1/2"	3-3/4"	Pkg. of 10
54239	239	1/8"	3-5/8"	3-7/8"	Pkg. of 10
54240	240	1/8"	3-3/4"	4"	Pkg. of 10
54241	241	1/8"	3-7/8"	4-1/8"	Pkg. of 10
54242	242	1/8"	4"	4-1/4"	Pkg. of 10
54243	243	1/8"	4-1/8"	4-3/8"	Pkg. of 10
54244	244	1/8"	4-1/4"	4-1/2"	Pkg. of 10
54245	245	1/8"	4-3/8"	4-5/8"	Pkg. of 10
54246	246	1/8"	4-1/2"	4-3/4"	Pkg. of 10
54247	247	1/8"	4-5/8"	4-7/8"	Pkg. of 10
54248	248	1/8"	4-3/4"	5"	Pkg. of 10
54249	249	1/8"	4-7/8"	5-1/8"	Pkg. of 5
54250	250	1/8"	5"	5-1/4"	Pkg. of 5
54251	251	1/8"	5-1/8"	5-3/8"	Pkg. of 5
54252	252	1/8"	5-1/4"	5-1/2"	Pkg. of 5
54253	253	1/8"	5-3/8"	5-5/8"	Pkg. of 5
54254	254	1/8"	5-1/2"	5-3/4"	Pkg. of 5
54255	255	1/8"	5-5/8"	5-7/8"	Pkg. of 5
54256	256	1/8"	5-3/4"	6"	Pkg. of 5
54257	257	1/8"	5-7/8"	6-1/8"	Pkg. of 5
54258	258	1/8"	6"	6-1/4"	Pkg. of 5
54325	325	3/16"	1-1/2"	1-7/8"	Pkg. of 5
54326	326	3/16"	1-5/8"	2"	Pkg. of 5
54327	327	3/16"	1-3/4"	2-1/8"	Pkg. of 5
54328	328	3/16"	1-7/8"	2-1/4"	Pkg. of 5
54329	329	3/16"	2"	2-3/8"	Pkg. of 5
54330	330	3/16"	2-1/8"	2-1/2"	Pkg. of 5
54331	331	3/16"	2-1/4"	2-5/8"	Pkg. of 5
54332	332	3/16"	2-3/8"	2-3/4"	Pkg. of 5
54333	333	3/16"	2-1/2"	2-7/8"	Pkg. of 5
54334	334	3/16"	2-5/8"	3"	Pkg. of 5
54335	335	3/16"	2-3/4"	3-1/8"	Pkg. of 5
54336	336	3/16"	2-7/8"	3-1/4"	Pkg. of 5





S.A.E. O-rings

Used for petroleum based fuel/oil, water, alcohol, some acids and bases.
 Temperature range -55oC to 120oC. Buna N-70R Nitrile Durometer A.
 Conforms to ASTM D2000 M2BF714, B14, EA14, EF11, EF21, EO14 & EO34.

PART#	INDUSTRY NUMBER	THICKNESS	INSIDE DIAMETER	OUTSIDE DIAMETER	QTY PER PKG.
54337	337	3/16"	3"	3-3/8"	Pkg. of 5
54338	338	3/16"	3-1/8"	3-1/2"	Pkg. of 5
54339	339	3/16"	3-1/4"	3-5/8"	Pkg. of 5
54340	340	3/16"	3-3/8"	3-3/4"	Pkg. of 5
54341	341	3/16"	3-1/2"	3-7/8"	Pkg. of 5
54342	342	3/16"	3-5/8"	4"	Pkg. of 5
54343	343	3/16"	3-3/4"	4-1/8"	Pkg. of 5
54344	344	3/16"	3-7/8"	4-1/4"	Pkg. of 5
54345	345	3/16"	4"	4-3/8"	Pkg. of 5
54346	346	3/16"	4-1/8"	4-1/2"	Pkg. of 5
54347	347	3/16"	4-1/4"	4-5/8"	Pkg. of 5
54348	348	3/16"	4-3/8"	4-3/4"	Pkg. of 5
54349	349	3/16"	4-1/2"	4-7/8"	Pkg. of 5
54350	350	3/16"	4-5/8"	5"	Pkg. of 5
54425	425	1/4"	4-1/2"	5"	Pkg. of 2
54426	426	1/4"	4-5/8"	5-1/8"	Pkg. of 2
54427	427	1/4"	4-3/4"	5-1/4"	Pkg. of 2
54428	428	1/4"	4-7/8"	5-3/8"	Pkg. of 2
54429	429	1/4"	5"	5-1/2"	Pkg. of 2
54430	430	1/4"	5-1/8"	5-5/8"	Pkg. of 2
54431	431	1/4"	5-1/4"	5-3/4"	Pkg. of 2
54432	432	1/4"	5-3/8"	5-7/8"	Pkg. of 2
54433	433	1/4"	5-1/2"	6"	Pkg. of 2
54434	434	1/4"	5-5/8"	6-1/8"	Pkg. of 2
54435	435	1/4"	5-3/4"	6-1/4"	Pkg. of 2
54436	436	1/4"	5-7/8"	6-3/8"	Pkg. of 2
54437	437	1/4"	6"	6-1/2"	Pkg. of 2

Metric O-Rings

Buna N-70R Nitrile Durometer A.

Conforms to ASTM D2000 M2BF714, B14, EA14, EF11, EF21, E014, E034.

<i>PART#</i>	<i>INSIDE DIAMETER</i>	<i>OUTSIDE DIAMETER</i>	<i>THICKNESS</i>	<i>QTY PER PKG.</i>
54501	3 mm	7 mm	2 mm	Pkg. of 10
54502	5 mm	9 mm	2 mm	Pkg. of 10
54503	6 mm	10 mm	2 mm	Pkg. of 10
54504	8 mm	12 mm	2 mm	Pkg. of 10
54505	10 mm	14 mm	2 mm	Pkg. of 10
54506	13 mm	17 mm	2 mm	Pkg. of 10
54507	10 mm	15 mm	2.5 mm	Pkg. of 10
54508	12 mm	17 mm	2.5 mm	Pkg. of 10
54509	14 mm	19 mm	2.5 mm	Pkg. of 10
54510	15 mm	20 mm	2.5 mm	Pkg. of 10
54511	16 mm	21 mm	2.5 mm	Pkg. of 10
54512	19 mm	23 mm	2.5 mm	Pkg. of 10
54513	20 mm	25 mm	2.5 mm	Pkg. of 10
54514	21 mm	26 mm	2.5 mm	Pkg. of 10
54515	22 mm	27 mm	2.5 mm	Pkg. of 10
54516	18 mm	25 mm	3.5 mm	Pkg. of 10
54517	20 mm	27 mm	3.5 mm	Pkg. of 10
54518	22 mm	29 mm	3.5 mm	Pkg. of 10
54519	23 mm	30 mm	3.5 mm	Pkg. of 10
54520	25 mm	32 mm	3.5 mm	Pkg. of 10
54521	27 mm	34 mm	3.5 mm	Pkg. of 10
54522	28 mm	35 mm	3.5 mm	Pkg. of 10
54523	30 mm	37 mm	3.5 mm	Pkg. of 10
54524	31 mm	38 mm	3.5 mm	Pkg. of 10
54525	32 mm	39 mm	3.5 mm	Pkg. of 10
54526	34 mm	41 mm	3.5 mm	Pkg. of 10
54527	36 mm	43 mm	3.5 mm	Pkg. of 10
54528	38 mm	45 mm	3.5 mm	Pkg. of 10
54529	41 mm	48 mm	3.5 mm	Pkg. of 10
54530	44 mm	51 mm	3.5 mm	Pkg. of 10
54531	46 mm	53 mm	3.5 mm	Pkg. of 10
54532	50 mm	57 mm	3.5 mm	Pkg. of 10





High Pressure O-Rings

Buna N-90R Nitrile Durometer A, rigid material, stronger.
Handles more pressure.

<i>PART#</i>	<i>INDUSTRY NUMBER</i>	<i>INSIDE DIAMETER</i>	<i>OUTSIDE DIAMETER</i>	<i>THICKNESS</i>	<i>QTY PER PKG.</i>
54901	901	1/16"	3/16"	5/16"	Pkg. of 10
54902	902	1/16"	1/4"	3/8"	Pkg. of 10
54903	903	1/16"	5/16"	7/16"	Pkg. of 10
54904	904	1/16"	11/32"	1/2"	Pkg. of 10
54905	905	1/16"	7/16"	9/16"	Pkg. of 10
54906	906	1/16"	15/32"	5/8"	Pkg. of 10
54907	907	1/16"	17/32"	11/16"	Pkg. of 10
54908	908	3/32"	21/32"	13/16"	Pkg. of 10
54909	909	3/32"	23/32"	29/32"	Pkg. of 10
54910	910	3/32"	3/4"	15/16"	Pkg. of 10
54911	911	1/8"	7/8"	1-3/32"	Pkg. of 10
54912	912	1/8"	15/16"	1-5/32"	Pkg. of 10
54913	913	1/8"	1"	1-7/32"	Pkg. of 10
54914	914	1/8"	1-1/16"	1-1/4"	Pkg. of 10
54916	916	1/8"	1-3/16"	1-3/8"	Pkg. of 10
54918	918	1/8"	1-3/8"	1-9/16"	Pkg. of 10
54920	920	1/8"	1-1/2"	1-3/4"	Pkg. of 10
54924	924	1/8"	1-3/4"	2"	Pkg. of 10
54928	928	1/8"	2-3/16"	2-3/8"	Pkg. of 10
54932	932	1/8"	2-3/8"	2-9/16"	Pkg. of 10

Nitrile (Buna-N NBR)

Nitrile rubber is the general item for acrylonitrile butadiene terpolymer. The acrylonitrile content of the nitrile sealing compounds varies considerably (18% to 50%) and influences the physical properties of the finished material. The higher the acrylonitrile content, the better the resistance to oil and fuel.

At the same time, elasticity and resistance to compression set is adversely affected. In view of these opposing realities, a compromise is often drawn, and a medium acrylonitrile content selected.

Nitrile has good mechanical properties when compared with other elastomers and high wear resistance. Nitrile is not resistant to weathering and ozone.

Heat Resistance:

Up to 212° F (100°C) with shorter life at 250°F (121°C).

Cold Flexibility:

Depending on individual compound, between -30°F and -70°F (-34°C and -57°C).

Chemical Resistance:

Aliphatic hydrocarbons (propane, butane, petroleum oil, mineral oil and grease,

diesel fuel, fuel oils) vegetable and mineral oils and greases.

HFA, HFB and HFC fluids.

Dilute acids, alkali and salt solutions at low temperatures.

Water (special compounds up to 212°F (100°C)).

Not compatible with:

Fuels of high aromatic content (for flex fuels a special compound must be used).

Aromatic hydrocarbons (benzene).

Chlorinated hydrocarbons (trichlorethylene).

Polar solvents (keytone, acetone, acetic acid, ethyleneester).

Strong acids.

Brake fluid with glycol base.

Ozone, weather and atmospheric aging.



PROPERTY	NITRILE	PROPERTY	NITRILE
Abraison Resistance	G	Impermeability	G
Acid Resistance	F	Oil Resistance	E
Chemical Resistance	FG	Ozone Resistance	P
Cold Resistance	G	Set Resistance	GE
Dynamic Properties	GE	Tear Resistance	FG
Electrical Properties	F	Tensile Strength	GE
Flame Resistance	P	Water Resistance	FG
Heat Resistance	G	Weather Resistance	F
E - Excellent		F - Fair	
G - Good		P - Poor	

00318k - O-Rings Merchandiser

Includes 2' x 2' Display Board with overlay stocked with O-Rings 006 to 336 (Part #54006 to 54336).

PLEASE CONSULT DYNALINE MERCHANDISER CATALOGUE FOR MORE INFO.

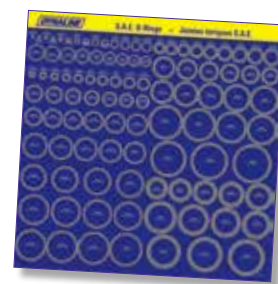



Straight



90°

45°

Metric Grease Fittings

Tested to 8,000 PSI, 08F Carbon Steel

BULK PACK PART#	QTY.	MINI-PACK PART#	QTY.	DYNAPAK PART#	QTY.	TYPE	THREAD	OVERALL LENGTH (MM)	INDUSTRY NUMBER
11114	100	11414	25	11114A	10	Straight	M6 x 1	15mm	2106
11115	100	11415	25	11115A	5	45°	M6 x 1	20.50mm	2107
11116	100	11416	25	11116A	5	90°	M6 x 1	19mm	2108
11117	100	11417	25	11117A	10	Straight	M8 x 1	15.7mm	2103
11118	100	11418	25	11118A	10	45°	M8 x 1	20.5mm	2104
11119	100	11419	25	11119A	5	90°	M8 x 1	19mm	2105
11120	100	11420	25	11120A	5	Straight	M10 x 1	16mm	2109
11126	100	11426	25	11126A	5	45°	M10 x 1	22.60mm	2110
11127	100	11427	25	11127A	5	90°	M10 x 1	21.40mm	2111



Drive-In

Drive-In Grease Fittings

Use a drive-in grease fitting tool to tap into desired area.
Tested to 8,000 PSI, 08F Carbon Steel.

BULK PACK PART#	QTY.	MINI-PACK PART#	QTY.	DYNAPAK PART#	QTY.	TYPE	DRILL SIZE	OVERALL LENGTH	INDUSTRY NUMBER
11131	100	11431	25	11131A	5	Drive In	3/16"	33/64"	1728-B
11132	100	11432	25	11132A	5	Drive In	1/4"	35/64"	1743-B
11133	100	11433	25	11133A	5	Drive In	5/16"	35/64"	1608-B
11134	100	11434	25	11134A	5	Drive In	3/8"	37/64"	1666

With Ball Check

S.A.E. Grease Fittings (Grease Zerk)

Tested to 8,000 PSI, 08F Carbon Steel

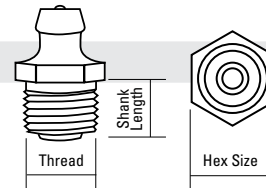

BULK PACK PART#	QTY.	MINI-PACK PART#	QTY.	DYNAPAK PART#	QTY.	TYPE	THREAD	OVERALL LENGTH	SHANK LENGTH (MM)	HEX SIZE (MM)	INDUSTRY NUMBER
11100	100	11400	25	11100A	10	Straight	1/8" NPT*	21/32" (17.52mm)	7.51mm	11mm	1610
11102	100	11402	25	11102A	5	45°	1/8" NPT*	7/8" (22.60mm)	7.50mm	11mm	1688
11104	100	11404	25	11104A	5	90°	1/8" NPT*	27/32" (21.40mm)	7.50mm	11mm	1613
11105	100	11405	25	11105A	10	Straight	1/4" - 28	1/2" (13.97mm)	4.8mm	8mm	1641
11106	100	11406	25	11106A	10	Straight	1/4" - 28 Long	11/16" (17.5mm)	9.10mm	8mm	1652
11107	100	11407	25	11107A	5	45°	1/4" - 28	7/8" (20.57mm)	5.15mm	9.50mm	1637
11109	100	11409	25	11109A	5	90°	1/4" - 28	25/32" (19.05mm)	5.15mm	9.50mm	1911
11110	50	11410	25	11110A	5	Straight	1/4" NPT*	15/16" (22.35mm)	10.7mm	14.30mm	1627
11112	100	11412	25	11112A	5	Straight	5/16" - 24UNF	21/32" (14.30mm)	4mm	9.50mm	1711
11113	100	11413	25	11113A	5	Straight	3/8" - 24UNF	9/16" (15.75mm)	6.35mm	11mm	1710

* NPT - National Pipe Thread
**UNF - Unified National Fine
*** Threads Per Inch

13000 - Grease Box

- A convenient and durable storage container for grease tubes.
- Features snap top lid, grip handles & carry strap.
- Provides safe storage and transportation, preventing spills & contamination.
- Stores 12 tubes upright, dust caps on.



13002 - Grease-2-Go!

- Can be fastened to a wall or equipment.
- Durable plastic material.
- Stores and protects two 14 oz. grease cartridges upright.



Pump Oilers

Seamless steel body and brass pump mechanism. Durable enamel painted finish. Supplied with flexible and rigid metal spouts.

PART#	TYPE	CAPACITY
13604	Pistol	4.4 oz. (125 cc)
13606	Pistol	6 oz. (180cc)
13607	Thumb Pump	7 oz. (200 cc)
13610	Thumb Pump	10.6 oz. (300 cc)
13617	Thumb Pump	17 oz. (500 cc)
13624	Thumb Pump	24 oz. (700 cc)



Oilers with Base

Ideal for oils, acids, adhesives, etc. Will not rust, leak or dent. Made of flexible, durable polyethylene. Removeable base for easy cleaning.

DYNALINE PART#	CLUTHE PART#	DESCRIPTION
13030	C30300	3" Nozzle, 6 oz./180 ml capacity, natural
13031	C30310	3" Nozzle, 10 oz./284 ml capacity, natural





Multi-Purpose Funnels

Flexible, durable, spark-proof, dent-proof, rust-proof polyethylene. Features a handy hang-up tab.

DYNALINE PART#	CLUTHE PART#	SIZE	CAPACITY	SPOUT DIAMETER	SPOUT LENGTH	OPENING DIAMETER
13504	C35040	4"	8 oz. (237 ml)	1/2"	2-1/2"	3-7/8"
13505	C35050	5"	14 oz. (414 ml)	1/2"	1-1/4"	4-3/4"
13506		6"	32 oz. (946 ml)	5/8"	2"	5-3/4"
13507	C35070	7"	28 oz. (828 ml)	1/2"	2-1/2"	6-3/4"
13508		8"	120 oz. (3.55 L)	1"	3-7/8"	7-5/8"
13510		10"	160 oz. (4.73 L)	1-1/2"	3-7/8"	9-7/8"

Funnel Sets

3-Piece Funnel Set

PART#	DESCRIPTION
13503	• One each of: 4", 5" and 6" Multi-Purpose Funnels

4-Piece Funnel Set

PART#	DESCRIPTION
13511	• One each of: 2", 3", 4", 5" Multi-Purpose Funnels.

Industrial Funnels

Made of flexible, durable, spark-proof, dent-proof, rust-proof, clear polyethylene. Features a handy hang-up tab. Supplied with one 100 mesh filter.

DYNALINE PART#	CLUTHE PART#	SIZE	CAPACITY	SPOUT DIAMETER	SPOUT LENGTH	OPENING DIAMETER
13003	C30030	3"	6 oz. (177 ml)	3/16"	1-7/8"	3"
13005	C30050	5"	24 oz. (710 ml)	1/2"	2-1/4"	5-3/8"
13009	C30090	9"	144 oz. (4.26 L)	1"	3-3/8"	8-1/2"

PART#	DESCRIPTION
C30450	• 5-1/2" wide spout, 24 oz. capacity, natural.

Automotive Funnel

Made of flexible, durable, spark-proof, dent-proof, rust-proof, clear polyethylene. Features a handy hang-up tab. Supplied with one 100 mesh filter.

DYNALINE PART#	CLUTHE PART#	SIZE	CAPACITY	SPOUT DIAMETER	SPOUT LENGTH	OPENING DIAMETER
13008	C30080	8"	120 oz. (3.5 L)	7/8"	5-1/4"	7-1/2"



Anti-Splash Funnels

Made of flexible, durable, spark-proof, dent-proof, rust-proof, clear polyethylene. Features a handy hang-up tab. Supplied with anti-splash rim and one 100 mesh filter.

DYNALINE PART#	CLUTHE PART#	SIZE	CAPACITY	SPOUT DIAMETER	SPOUT LENGTH	OPENING DIAMETER
13015	C30150	5"	24 oz. (710 ml)	1/2"	2-1/4"	5-1/4"
13019	C30190	9"	144 oz. (4.26 L)	1"	3-3/8"	8-1/4"



2-In-1 Flexible Spout Funnel

Complete with mesh filter. Detachable spout.

PART#	SIZE	SPOUT DIAMETER	SPOUT LENGTH	OPENING DIAMETER
14015	15.6"	3/8"	10"	6-1/2"



NEW!
Makes Changing Fluid Easy!

Foldable Funnel

Some things are just too cool not to own.

This moldable rubber device can be shaped to divert oil or any liquid around engine parts and into your drain pan. Guaranteed no-mess oil changes. Bend it, fold it, mold it and the shape stays put and the funnel stays in place for hands-free use. Perfect for draining fluids from any vehicle or equipment including cars, trucks, motorcycles, aircraft, boats, generators, snow blowers, mowers and more.

Made from a thick, pliable Nitrile rubber encasing a thin pliable piece of aluminum alloy. Fluids from -30°F to 450°F won't harm the surface. Dyanline Foldable Funnel cleans up easily with a wipe.

Store it flat or roll it up to fit in any space.

PART#	SIZE
15009	9" x 4-3/4"
15014	14-1/2" x 6-1/2"

15014 Shown





Replacement Funnel Filter

Fits industrial, automotive and anti-splash funnels.

PART#	FEATURES	DIAMETER	QTY. PER PKG.
13100	100 Mesh	2"	10



Transmission Funnel

Detachable spout.

PART#	OVERALL LENGTH	SPOUT DIAMETER	SPOUT LENGTH	OPENING DIAMETER
14017	22"	3/8"	16"	5-1/2"



Super Funnel

PART#	OVERALL LENGTH	SPOUT DIAMETER	SPOUT LENGTH	OPENING DIAMETER
14018	18"	3/8"	7"	5"



Dirt Free Funnel

Flexible, durable, spark proof, dent proof, leak proof. Large handle. Removable caps on opening and spout prevent foreign material from entering when not in use.

PART#	OVERALL LENGTH	COLOUR	OPENING DIAMETER	SPOUT DIAMETER
14035	15"	Yellow	4-1/2"	5/8"
14037	17"	Orange	4-1/2"	9/16"



Heavy Duty Flex Spout Funnel

Heavy duty. Complete with metal filter screen.

PART#	OVERALL LENGTH	COLOUR	OPENING DIAMETER	SPOUT DIAMETER
14013	17"	Orange	7"	3/4"

MEASURERS & FILLERS

Suitable for water, oil, gasoline and anti-freeze. Made of tough, durable polyethylene.

Measurer with Lid & Nozzle

Will not rust, dent or leak. Ideal for handling all kinds of fluids. Embedded lid and nozzle.

PART#	CAPACITY	SPOUT DIAMETER	SPOUT LENGTH
14040	1 gal. (4 L)	5/8"	2-3/4 / 8-14"



Measuring Container

US, Imperial, and Metric graduations. Ideal for fluids and dry material.

DYNALINE	CLUTHE		
PART#	PART#	CAPACITY	DESCRIPTION
13402	C34026	84.5 oz./2.5L	Calibrated measurer with detachable lid and nozzle
14025	C34020	84.5 oz./2.5L	Calibrated measurer
14045X	C34046	152 oz./4.5L	Calibrated measurer with detachable lid and nozzle
13404	C34040	152 oz./4.5L	Calibrated measurer



14025/ 13402 Shown

Measurer w/Fixed Lid & Nozzle

US, Imperial, and Metric graduations. Ideal for fluids and dry material.

PART#	CAPACITY	SPOUT DIAMETER	SPOUT LENGTH	LID TYPE
14045	152 oz. (4.5L)	7/16"	5"	Blow molded fixed lid



Portable Measurer

Supplied with shut off valve and cold temperature hose. Used to transport, dispense and measure fluids including motor oil, hydraulic fluids and antifreeze. Common applications are heavy trucks, construction and farm equipment.

PART#	CAPACITY	DIMENSIONS	SPOUT LENGTH	HOSE LENGTH
14047	5L	11-1/4"L x 6-1/2"H	3-1/2"	18"



Measuring Scoops

US, Imperial, and Metric graduations. Ideal for handling dry materials.

DYNALINE	CLUTHE		
PART#	PART#	CAPACITY	DESCRIPTION
13311	C33110	52 oz. (1.5L)	7" scoop, 11-1/2" overall length, translucent
13314	C33140	104 oz. (3L)	10" overall length, translucent



Automatic Battery Filler

Safety nozzle/push-in style. Automatic shut-off to help prevent spilling and over filling.

PART#	CAPACITY	SPOUT DIAMETER	SPOUT LENGTH
14024	1/2 gal. (2 L)	7/32"	2-1/2"





METAL LUBRICATION PRODUCTS

Tin Funnel

Made of lightweight tin coated steel.

PART#	CAPACITY	DIAMETER	SPOUT DIAMETER	SPOUT LENGTH
13550	5 oz. (148 ml)	3-1/2"	2-1/8"	3/8"



Tractor Funnel

Heavy duty galvanized steel. Comes with one gold mesh filter, 11-1/2" high.

PART#	CAPACITY	DIAMETER	TIP OUTSIDE DIAMETER	SPOUT DIAMETER	SPOUT LENGTH
13811	8 qt. (7.5 L)	9-1/2"	1"	1"	3-5/8"



Offset Transmission Funnel

PART#	CAPACITY	DIAMETER	FIXED SPOUT DIAMETER	FLEX SPOUT DIAMETER	FLEX SPOUT LENGTH
14008	2 L	7"	1"	5/8"	17"



Transmission Funnel

Galvanized metal. Complete with mesh filter.

PART#	CAPACITY	DIAMETER	FIXED SPOUT DIAMETER	FLEX SPOUT DIAMETER	FLEX SPOUT LENGTH
14014	1 L	5-1/2"	5/8"	1/2"	14"



Metal Measurer

Made of heavy duty galvanized steel. Complete with flex spout and easy grip handle.

PART#	CAPACITY	SPOUT DIAMETER	SPOUT LENGTH
14140	4 qt. (4 L)	1/2"	7-1/2"

Sealable Drain Pan

Made of rugged high-density polyethylene. Features easy to use carrying handles.

PART#	CAPACITY	LENGTH	DEPTH	WIDTH
14026	10L	22-3/8"	5"	12-5/8"



NEW!

Truck & Trailer Drain Pan

Made of rugged high-density polyethylene. Features easy to use carrying handles.

PART#	DESCRIPTION	CAPACITY
14019	Fits rims 13-3/4" (inside diameter) and larger.	3L



Drain Pans

Made of rugged high-density polyethylene.

PART#	CAPACITY	LENGTH	DEPTH	WIDTH
14022	16L	23"	5-1/2"	18"
14023	24L	32"	7-1/2"	21-1/2"



14022



14023

NEW!

Easy Flow Funnel

Offset spout for the hard to reach areas. For oils and other engine fluids. Perfect for small engines, lawnmowers, ATV's, Motorcycles, Tractors, Generators, Pressure washers, Trucks and Motorized equipment.

PART#	CAPACITY	LENGTH	SPOUT DIA.	DIAMETER
13007	1L	16"	1/2"	5"





TOW-PRO™

Ball Mounts

Pintle Hooks

Couplers

Towing Accessories

Jacks

Trailer Balls

Mud Flaps

Wheel Chocks

**Multiple Ball
Mounts**

Wheel Locks



**Professional Quality
TRAILER & TOWING**

Trailer Balls

Internal, External Thread, & Heavy Duty . . . 1

Trailer Balls Retail Packaged

Internal, External Thread 2

Trailer Balls Accessories 2

Trailer Couplers

Channel Couplers 3

A-Frame Couplers 3

Trailer Coupler Repair Kits 3

A-Frame Coupler Forged Head 3

Easy Guide Trailer Couplers 4

Adjustable Brackets 5

Lift Coupler Handle 5

Adjustable Tow Bar 5

Security Cable 5

Trailer Locks & Pins

Coupler & Receiver Lock 6

Trailer Lock Kit 6

Receiver Pull Pins 7

Spring Latches 7

Hitch Lock 7

Trailer Ball Mounts

Class 1, 3, 4 & 5 Ball Mounts 8-9

Super Duty Steel Ball Mount 9

Forged Aluminum Ball Mount - Solid Shank
9

Ball Mounts Kits 9-10

Multiple Ball Mounts - Welded Balls

Round Shank & Square Shank 10-11

Clevis & Shackle Ball Mount 11

Adjustable Ball Mounts

Adjustable Ball Mount 11-12

Hitch Extension 12

Hitch Adapters

Hitch Adapter 13

Receiver Tubes

Receiver Tubes 13

Pintle Hooks

Pintle Hooks & Mounts 13-14

Towing Rings

Towing Rings 14

LED Trailer Towing Kits

LED Kits 15

Towing Mirrors

Clip-On Towing Mirror 16

Dual Clip-On Towing Mirror 16

Deluxe Door Mount Towing Mirror 16

Trailer Connectors

2, 4, 5, 6, & 7 Connectors 17-20

Brake Controllers

Hayes Quick Connect 21

Wire Harnesses - Hayes

Reference Chart 22-23

OEM 24

JacksPower, Swing Way, Implement, A-Frame, Round
& Square 25-29

Leveling Scissor and Stabilizer Jack 29

Replacement Parts & Accessories

Fifth Wheel King Pin Stabilizer 30

High Speed Trailer Wheels 30

Wheel Locks 31

Wheel Chocks 31

Mud Flaps 31

TRAILER BALLS

Solid steel. Bright chrome plated finish. Meets or exceeds VESC V-5 safety specifications

Internal Thread

Part#	Ball Diameter	Shank Diameter	Shank Length	Gross Load Rating
11148	1-7/8"	3/4"	1-3/4"	2,000 lb
11149	2"	3/4"	1-3/4"	3,500 lb



External Thread

Part#	Ball Diameter	Shank Diameter	Shank Length	Gross Load Rating
11147	1-7/8"	1"	2-5/8"	3,500 lb
11151	1-7/8"	3/4"	1-1/2"	2,000 lb
11152	2"	3/4"	1-1/2"	3,500 lb
11153	2"	1"	2-5/8"	5,000 lb
11154	2-5/16"	1"	2-5/8"	5,000 lb
11155	2-5/16"	1-1/4"	2-5/8"	10,000 lb
11155H	2-5/16"	1-1/4"	2-1/4"	14,000 lb
11155X	2-5/16"	1-1/4"	2-5/8"	12,000 lb
11258	2"	1-1/4"	2-1/4"	8,000 lb



Long Shank External Thread

Part#	Ball Diameter	Shank Diameter	Shank Length	Gross Load Rating
11250	1-7/8"	1"	3"	2,000 lb
11251	1-7/8"	3/4"	3-1/4"	2,000 lb
11252	2"	3/4"	3-1/4"	3,500 lb
11257	2"	1"	3-1/4"	5,000 lb
11263	2-5/16"	1"	3"	6,000 lb



Extra Lift External Thread

Part#	Ball Diameter	Shank Diameter	Shank Length	Rise Height	Gross Load Rating
11253	2"	2-5/8"	2-5/8"	1"	3,500 lb
11254	2"	1"	1-3/4"	2"	3,500 lb
11255	2-5/16"	1-1/4"	2-1/4"	1"	7,000 lb
11256	2-5/16"	1-1/4"	2"	2"	5,000 lb



External Thread - Heavy Duty

Part#	Description	Ball Diameter	Shank Diameter	Shank Length	Rise Height	Gross Load Rating
11259	Solid steel. Black powder finish.	2-5/16"	1-1/4"	2-5/8"	Standard	30,000 lb
11260	Solid steel. Black powder finish.	2-5/16"	1-1/4"	2-5/8"	1"	30,000 lb
11261	Solid steel. Black powder finish.	2-5/16"	1-1/4"	2-1/2"	2"	30,000 lb



TRAILER BALLS - RETAIL PACKAGED

Solid steel. Bright chrome plated finish. Meets or exceeds VESC V-5 safety specifications

**Internal Thread**

<i>Part#</i>	<i>Ball Diameter</i>	<i>Shank Diameter</i>	<i>Shank Length</i>	<i>Gross Load Rating</i>
11148P	1-7/8"	3/4"	1-3/4"	2,000 lb
11149P	2"	3/4"	1-3/4"	3,500 lb

External Thread

<i>Part#</i>	<i>Ball Diameter</i>	<i>Shank Diameter</i>	<i>Shank Length</i>	<i>Gross Load Rating</i>
11147P	1-7/8"	1"	2-5/8"	3,500 lb
11151P	1-7/8"	3/4"	1-1/2"	2,000 lb
11152P	2"	3/4"	1-1/2"	3,500 lb
11153P	2"	1"	2-5/8"	5,000 lb
11154P	2-5/16"	1"	2-5/8"	5,000 lb
11155P	2-5/16"	1-1/4"	2-5/8"	10,000 lb
11155HP	2-5/16"	1-1/4"	2-1/4"	14,000 lb
11155XP	2-5/16"	1-1/4"	2-5/8"	12,000 lb
11251P	1-7/8"	3/4"	3-1/4"	2,000 lb
11252P	2"	3/4"	3-1/4"	3,500 lb

TRAILER BALL ACCESSORIES

Black plastic with generic label.

Trailer Ball Replacement Holder

<i>Part#</i>	<i>Description</i>	<i>Fits</i>
TB001	Small - 6.89" x 2.28" x 2.52"	11148, 11149, 11151, 11152
TB002	Large - 7.36" x 2.64" x 2.99"	11147, 11153, 11154, 11155, 11155H, 11155X

Trailer Ball Reducer Bushing

Clamshell packaged.

<i>Part#</i>	<i>Description</i>
11170	Trailer Ball Reducer Bushing, 1" to 3/4"
11171	Trailer Ball Reducer Bushing, 1-1/4" to 1"



TRAILER COUPLERS

A coupler is a mechanism that is bolted or welded onto the end of a trailer tongue. It fits securely over - and pivots on - the tow vehicle hitch ball.

Channel Couplers

Features large trigger-action latch designed for ease of operation. Zinc plate finish. Stamped steel construction. Easy to install.

<i>Part#</i>	<i>Ball Size</i>	<i>Channel Size</i>	<i>Gross Load Rating</i>
11156	1-7/8"	2"	2,000 lb
11157	1-7/8"	2-1/2"	2,000 lb
11158	1-7/8"	3"	2,000 lb
11159	2"	2-1/2"	3,500 lb
11159N	2"	2"	3,500 lb
11160	2"	3"	3,500 lb



A-Frame Couplers

Features large trigger-action latch designed for ease of operation. Zinc plate finish. Stamped steel construction. Easy to install.

<i>Part#</i>	<i>Ball Size</i>	<i>Type</i>	<i>Gross Load Rating</i>
11161	2"	Standard	5,000 lb
11162	2-5/16"	Standard	10,000 lb



Trailer Coupler Repair Kits

Repair kit available for both 1-7/8" and 2" ball channel couplers. Zinc plate finish.

<i>Part#</i>	<i>Description</i>
11163	For 1-7/8" Ball Channel Coupler
11164	For 2" Ball Channel Coupler



A-Frame Couplers - Forged Head

Class 3 A-Frame coupler with a forged head.

<i>Part#</i>	<i>Ball Size</i>	<i>Type</i>	<i>Gross Load Rating</i>
11861	2"	Low Profile	5,000 lb
11862	2-5/16"	Low Profile	12,500 lb



EASE-GUIDE™ TRAILER COUPLERS

Ease-Guide™ trailer couplers are a revolutionary new style of coupler that provide a 5" square area to position your hitchball into rather than positioning directly over top like traditional trailer couplers. This means you don't have to get in and out of your vehicle several times to line up your trailer coupler

perfectly over your hitch ball. before coupling the trailer to your vehicle. Once you have lowered your trailer equipped with **Ease-Guide™** coupler onto your hitch ball, you simply drive forward and leave the patented holding socket to guide itself onto the hitch ball and then insert the locking pin.



3" Tubular Mount Ease-Guide

<i>Part#</i>	<i>Ball Size</i>	<i>Hitch Pin</i>	<i>Gross Load Rating</i>
11563	2-5/16"	66254	12,500 lb
11567	2"	66252	9,000 lb



50° A-Frame Ease-Guide

<i>Part#</i>	<i>Ball Size</i>	<i>Hitch Pin</i>	<i>Gross Load Rating</i>
11564	2-5/16"	66254	12,500 lb
11568	2"	66252	9,000 lb



Vertical Channel Mount Ease Guide

<i>Part#</i>	<i>Ball Size</i>	<i>Hitch Pin</i>	<i>Gross Load Rating</i>
11565	2-5/16"	66254	15,000 lb
11569	2"	66252	9,000 lb



Gooseneck Coupler Ease-Guide

<i>Part#</i>	<i>Ball Size</i>	<i>Hitch Pin</i>	<i>Gross Load Rating</i>
11566	2-5/16"	66253	24,000 lb



Adjustable Couplers

Designed for utility, livestock and construction applications where height adjustment is required.

<i>Part#</i>	<i>Ball Size</i>	<i>Tongue Weight</i>	<i>Max. Gross Load</i>	<i>Overall Dimensions</i>
11864	2"	1,000 lb	10,000 lb	9" L x 5-1/2" W
11865	2-5/16"	1,400 lb	14,000 lb	9-1/4" L x 5-3/4" W

Adjustable Brackets

Designed for adjustable couplers

Part#	Description	Hole Diameter	Capacity	Outside Width	Inside Width	Overall Length
11866	12 hole (6 pairs)	5/8"	16,000 lb	3-5/8"	3"	11-1/2"
11867	8 hole (4 pairs)	5/8"	16,000 lb	3-5/8"	3"	7-1/2"



Lifter Coupler Handle

For easy lifting of trailer tongue on small trailers.

Part#	Description
11870	Zinc plated with rubber coating on the handle. Handle attaches to coupler mounting bolts.



Adjustable Tow Bar

Class 3. Adjustable tow bar width of 26" to 41". Includes 2" coupler and one set of universal bumper brackets. Black powder coated coupler. Base plate may be required.

Part#	Description
11880	Class III, 5,000 lb GVW





HELP YOUR SELF

.. OR THEY'LL HELP THEMSELVES



PARTNERS IN CRIME PREVENTION

Security Cable

Galvanized steel cable. Double looped with vinyl cover. Designed for use with padlocks. Cardstock packaged.

Part#	Diameter	Length
65095	3/8"	6'
65096	3/8"	3'



2251526

65096

*Padlock sold separately (see Boss Catalogue page 17)

TRAILER LOCKS & PINS

Theft deterrent is the primary function of trailer locks. Feel secure knowing your trailer and cargo are safe.



Coupler Lock

Part#	Description	Diameter	Usable Length
66276	Fits all latch-type couplers. Two keys supplied. Yellow dichromate finish. Clamshell packaging.	1/4"	7/8" (closed)



Coupler Lock & Receiving Set

Part#	Description	Receiver Diameter	Usable Length	Coupler Lock	Usable Length
66277	Fits most receiver hitches and latch-type couplers. Same key fits both locks. Chrome plated. Clamshell packaging.	5/8"	2-3/4"	1/4"	1"



Receiver Lock Pins

Two sizes to fit most receiver-type hitches. Two keys supplied. Bright chrome plated pin. Black enamel painted lock body.

Part#	Diameter	Usable Length	Tensile Strength
66274	1/2"	2-1/2"	5,500 lb
66275	5/8"	3"	8,800 lb



65086

Universal Trailer Coupler Locks

Bent at the perfect angle for easy removal. Made from oil tempered spring wire. Clear zinc plated finish. Features a locking bar with 6 locking positions.

Part#	Description
65085	Light Duty. Fits 1-7/8", 2" and 2-5/16" Couplers.
65086	Heavy Duty . Fits 1-7/8", 2" and 2-5/16" Couplers.



Trailer Lock Kit

Spring loaded bolt can be locked in the open position. Zinc plated bolt housing and keeper. Turning lever allows the bolt to close under spring pressure.

Part#	Description	Contents
65087	Keyed alike.	Light duty Universal Trailer Coupler Lock , Brass Coupler lock , Dual bent Pin Hitch lock (fits 5/8 and 1/2 receivers)

Receiver Pull Pins

For securing ball mounts to receiver-type hitches. Supplied with vinyl coated grip EZ clip.

Part#	Material	Diameter	Usable Length
66267	Stainless Steel - Won't Rust!	1/2"	3"
66268	Stainless Steel - Won't Rust!	5/8"	3"
66269	Stainless Steel - Won't Rust!	5/8"	3-1/2"
66270	High carbon steel, zinc plated.	1/2"	3"
66270P	As 66270 above, carded.	1/2"	3"
66271	High carbon steel, zinc plated.	5/8"	3"
66271P	As 66271 above, carded.	5/8"	3"
66272	High carbon steel, zinc plated.	5/8"	3-1/2"



EZ-Clips

Bent at the perfect angle for easy removal. Made from oil tempered spring wire. Clear zinc plated finish.

Part#	Description	Wire Diameter	Pkg. Qty.
66265	Clear zinc plated finish.	0.148"	25
66266	Vinyl coated non-slip grip.	0.148"	10
96266	Vinyl coated non-slip grip.	0.148"	2



Spring Latches

Spring loaded bolt can be locked in the open position. Zinc plated bolt housing and keeper. Turning lever allows the bolt to close under spring pressure.

Part#	Pin Diameter	Handle Type	Bracket Length	Bracket Width	Overall Length	Mounting Hole Diameter
23057	7/16"	Loop	3-3/8"	1-1/2"	7-1/4"	3/16"
23058	1/2"	4" L shape	3-1/8"	1-3/4"	5-1/2"	1/4"



Hitch Lock

Chrome plated, weather proof cap. Clamshell packaged.

Part#	Type	Diameter	Usable length
65091	Sleeved Barrel	5/8" or 1/2"	2-1/2"
65092	Bent Pin	5/8"	3"
65093	Dual Bent Pin	5/8" & 1/2"	--



TRAILER BALL MOUNTS

Solid one piece or robotically welded. One section of ball mounts ranging from class 1 to 5 are corrosion resistant with black powder or chrome finish. Forged steel or aluminum.

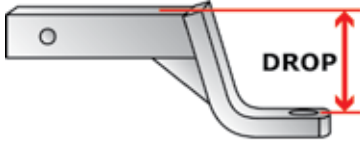

DROP

The distance from the top of the shank to the top of the ball platform

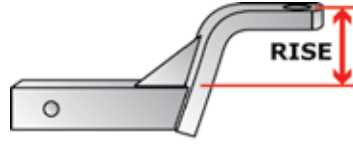

RISE

The distance from the top of the shank to the top of the ball platform

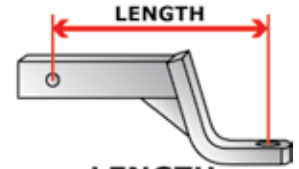

LENGTH

The distance from the center of the ball hole to the center of the pin hole



Class 1 Ball Mounts

Robotic welded, solid shank. Fits 1-1/4" Class 1 receiver tubes. Black powder coated finish.

Part#	Finish	Class	TW (lb)	GTW (lb)	Hole	Drop	Rise	Length
11670	Black	1	200 lb	2,000 lb	3/4"	1-1/4"	5/8"	6-3/4"
11671	Black	1	200 lb	2,000 lb	3/4"	2-3/4"	2-1/8"	7"
11672	Black	1	200 lb	2,000 lb	3/4"	3-1/2"	3"	9-1/2"



Class 3-4 Ball Mounts

Robotic welded, hollow shank. Fits 2" receivers. Black powder coated & chrome finish.

Part#	Finish	Class	TW (lb)	GTW (lb)	Hole	Drop	Rise	Length
11600	Black	3	500 lb	5,000 lb	1"	Straight	Straight	10-1/2"
11601	Black	4	600 lb	6,000 lb	1"	2"	3/4"	8-1/4"
11602	Black	4	600 lb	6,000 lb	1"	4"	3"	9-1/4"
11603	Black	4	600 lb	6,000 lb	1"	6"	5"	11"
11611	Chrome	4	600 lb	6,000 lb	1"	2"	3/4"	8"
11612	Chrome	4	600 lb	6,000 lb	1"	4"	3"	8-3/4"



Class 4 Forged Steel Ball Mounts

Solid one piece, forged ball mount. Fits 2" receivers. Black powder coated finish.

Part#	Finish	Class	TW (lb)	GTW (lb)	Hole	Drop	Rise	Length
11586	Black	4	1,000 lb	10,000 lb	1-1/4"	2"	1"	9"
11587	Black	4	1,000 lb	10,000 lb	1-1/4"	4"	3"	9-1/2"
11588	Black	4	1,000 lb	10,000 lb	1-1/4"	6"	5"	11"
11660	Black	4	1,000 lb	10,000 lb	1"	2"	1"	9"
11661	Black	4	1,000 lb	10,000 lb	1"	4"	3"	9-1/2"
11662	Black	4	1,000 lb	10,000 lb	1"	6"	5"	11"

Class 5 Forged Steel Ball Mounts

Solid one piece forged ball mount. Fits 2" receivers. Black powder coated finish.

Part#	Finish	Class	TW (lb)	GTW (lb)	Hole	Drop	Rise	Length
11686	Black	5	1,200 lb	12,000 lb	1-1/4"	2"	1"	9"
11687	Black	5	1,200 lb	12,000 lb	1-1/4"	4"	3"	9-1/2"
11688	Black	5	1,200 lb	12,000 lb	1-1/4"	6"	5"	11"



Class 5 Welded Shank Ball Mount

Robotic welded, solid shank. Fits 2" receivers. Black powder coated finish.

Part#	Finish	Class	TW (lb)	GTW (lb)	Hole	Drop	Rise	Length
11689	Black	5	1,200 lb	12,000 lb	1-1/4"	3"	2"	10"

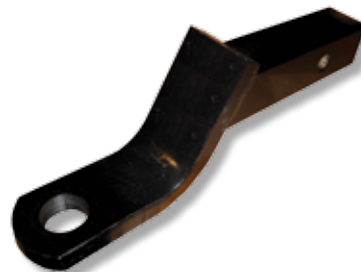

Super Duty Steel Ball Mounts

Robotic welded, hollow shank. Fits 2-1/2" receivers. Black powder coated finish.

Part#	Finish	Class	TW (lb)	GTW (lb)	Hole	Drop	Rise	Length
11690	Black	4	1,000 lb	10,000 lb	1-1/4"	3"	1-1/2"	9-3/4"
11691	Black	4	1,000 lb	10,000 lb	1-1/4"	5"	3-1/2"	10"
11692	Black	4	1,000 lb	10,000 lb	1-1/4"	8"	6-1/2"	10-1/2"



Forged Aluminum Ball Mounts - Solid Shank

Solid high strength forged aluminum shank. Fits 2" receivers.

Part#	Finish	Class	TW (lb)	GTW (lb)	Hole	Drop	Rise	Length
11576	Aluminum	4	600 lb	6,000 lb	1"	2"	1"	7-1/4"
11577	Aluminum	4	600 lb	6,000 lb	1"	3"	2-1/4"	7-1/4"
11583	Aluminum	4	800 lb	8,000 lb	1"	2"	1"	8-1/2"
11584	Aluminum	4	800 lb	8,000 lb	1"	4"	3"	9-1/2"
11585	Aluminum	4	800 lb	8,000 lb	1"	6"	5"	10-3/4"



Ball Mount Kits

Includes ball mount, welded trailer ball and pull pin. Fits 2" receivers.

Part#	Finish	Class	Ball	TW (lb)	GTW (lb)	Drop	Rise	Length
11590	Black	4	1-7/8"	500 lb	5,000 lb	2"	1"	8-1/4"
11591	Black	4	2"	600 lb	6,000 lb	2"	1"	8-1/4"
11592	Black	4	2-5/16"	600 lb	6,000 lb	2"	1"	8-1/4"
11641	Chrome	4	2"	600 lb	6,000 lb	2"	1"	8-1/4"





ATV Ball Mount Kit

2" receiver and ball mount. Bolts to frame with 3/4" bolt and locknuts (supplied).

Ball mount is removable with pull pin and clip (supplied). Welded loop for attaching tow straps or shackles.

Part#	Finish	TW (lb)	GTW (lb)	Holes
11655	Black	500 lb	3,500 lb	1" & 3/4"

MULTIPLE BALL MOUNTS - WELDED BALLS
 Solid round shank with welded balls. Fits standard 2" square receivers.
 No need to remove when changing - **just pull the pin and turn!**



Round Shank - Triple

Solid round shank with welded balls. Fits standard 2" square receivers.
 No need to remove when changing - just pull the pin and turn!

Part#	Finish	Class	Ball	TW (lb)	GTW (lb)	Drop	Rise	Length
11648	Black	3-4	1-7/8"	350 lb	3500 lb	Straight	Straight	7-1/2"
			2"	600 lb	6,000 lb			
			2-5/16"	1000 lb	10,000 lb			



Round Shank - Reversible

Solid round shank with welded balls. Fits standard 2" square receivers. No need to remove when changing - just pull the pin and turn!

Part#	Finish	Class	Ball	TW (lb)	GTW (lb)	Drop	Rise	Length
11647	Black	3	2" 2-5/16"	600 lb 1,000 lb	6000 lb 10,000 lb	Straight	Straight	7-1/2"



Square Shank - Reversible

Solid shank with welded balls. Fits 2" receivers.

Part#	Finish	Class	Ball	TW (lb)	GTW (lb)	Drop	Rise	Length
11604	Black	3-4	1-7/8", 2"	350 lb, 600 lb	3500 lb, 6,000 lb	Straight	Straight	7-1/4"
11605	Black	3-4	2", 2-5/16"	600 lb, 1,000 lb	6000 lb, 10,000 lb	Straight	Straight	7-1/4"
11644	Black	3	1-7/8", 2"	350 lb, 600 lb	3500 lb, 6,000 lb	2"	3/4"	8"
11645	Black	3	2", 2-5/16"	600 lb, 1,000 lb	6000 lb, 10,000 lb	2"	3/4"	7-1/4"

Square Shank - Triple

Fits 2" receivers, 5/8" hole size.

Part#	Description	Finish	Class	Ball	TW (lb)	GTW (lb)	Length
11606	Solid square shank with welded balls & tow hook	Black	3-4	1-7/8"	350 lb	3500 lb 6000 lb 10,000 lb	8"
				2"	600 lb		8"
				2-5/16"	1000 lb		8"
11607	Solid square shank with welded balls	Black	3-4	1-7/8"	350 lb	3500 lb 6000 lb 10,000 lb	8"
				2"	600 lb		8"
				2-5/16"	1000 lb		8"
11652	Hollow shank with welded balls	Black	3-4	1-7/8"	200 lb	2,000 lb 6,000 lb 10,000 lb	8"
				2"	600 lb		8"
				2-5/16"	1000 lb		8"



11606



11652

Clevis Ball Mount

Solid shank. Can be used as a standard ball mount.

Part#	Finish	TW (lb)	GTW (lb)	Tube	Hole	Length
11579	Black	600 lb	6,000 lb	Straight	1"	10-1/2"



Shackle (Tow Strap) Ball Mount

For use with recovery straps on pickups and ATVs. Black powder coated finish with zinc plated shackle. Fits 2" receivers.

Part#	Finish	TW (lb)	GTW (lb)	Overall Length	Shank Type	Shackle Diameter
11693	Black	600 lb	6,000 lb	9-3/8"	Hollow	5/8"
11694	Black	1000 lb	10,000 lb	10"	Solid	3/4"



Adjustable Triple Ball Mounts

High grade solid steel for maximum strength. 3-pin design for easy adjustment (pins & clips included). Straight to 6-1/2" maximum drop/rise. 2" x 2" solid shank. Meets S.A.E. J684/V-5.

Part#	Class	Ball	TW (lb)	GTW (lb)
11650	3-4	1-7/8"	600 lb	6,000 lb
		2"	1,000 lb	10,000 lb
		2-5/16"	1,000 lb	10,000 lb



Adjustable Ball Mounts (Single Platform)

Black powder coated finish. Perfect for use on tow trailers of various coupler heights. Can be used in the rise or drop position as needed. Fits 2" receiver. Trailer hole size is 1". Pull pin & clip are included.

Part#	Finish	Class	TW (lb)	GTW (lb)	Length	Adjustment
11595	Black	3	600 lb	6,000 lb	12-1/2"	2" to 7-3/4" drop, up to 6-1/2" rise



ADJUSTABLE BALL MOUNTS

Black powder coated finish. Perfect for use on tow trailers of various coupler heights.
Can be used in the rise or drop position as needed. Two pieces, comes with pull pins & clips.

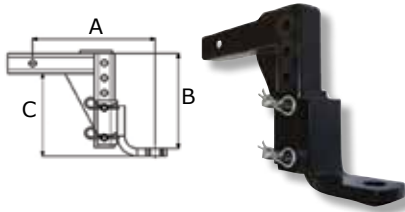

Adjustable Ball Mount

Fits 2" receivers. To be used with 1" diameter shank trailer ball.

Part#	Finish	TW (lb)	GTW (lb)	Length (A)	Drop (B)	Height (C)
11561	Black	500 lb	5,000 lb	12-1/4"	5"-9-1/2"	3-3/4"-8-1/4"

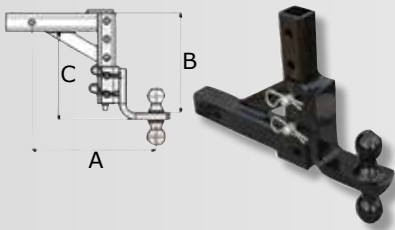

Adjustable Double Ball Mount

Solid steel with 5/8" pin hole. 1-7/8" ball supports up to 2,000 lb; 2" ball supports up to 5,000 lb

Part#	Receiver Opening	Length (A)	Drop (B)	Height (C)
11562	2"x2"	13-1/2"	4-4/5" - 10-4/5"	3-3/5" - 9-3/5"

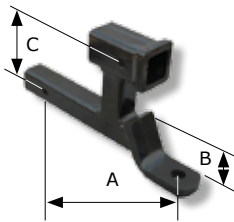

Multi-Use Ball Mount

Tow and carry hitch mounted accessories at the same time.

Part#	Finish	TW (lb)	GTW (lb)	Length (A)	Drop (B)	Height (C)
11560	Black	500 lb	5,000 lb	12-1/4"	2-1/4"	5-4/5"

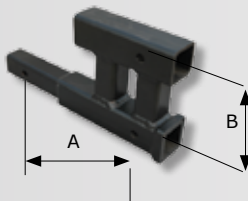

Dual Hitch Extension

Fits 2" receivers.

Part#	Finish	TW (lb)	GTW (lb)	Length (A)	Height (B)
11780	Black	400 lb	4,000 lb	12-1/4"	6-1/4"



Step Bumper Receiver

Fits 2" receivers.

Part#	Finish	TW (lb)	GTW (lb)
11782	Black	500 lb	5,000 lb

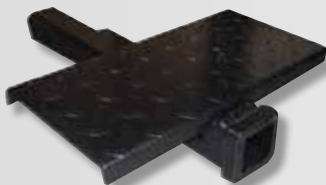

Hitch Box Extension

Service step. 2" extension only.

Part#	Description	TW (lb)	GTW (lb)
11784	14" x 7" stepping area	400 lb	4,000 lb

HITCH ADAPTERS

Ideal for cargo carriers and bike carriers. Black powder coated finish.
Not to be used for towing.

Part#	Description
11785	Decrease receiver opening from 2-1/2" to 2", 5/8" pin, 5" in length.
11786	Decrease receiver opening from 2" to 1-1/4", 5/8" pin hole, 3-1/2" length.
11787	Increase receiver opening from 1-1/4" to 2", GTW 3500 lb
11788	Decrease receiver opening from 2" to 1-1/4", GTW 3500 lb
11789	8-1/2" Length, fits 2" receivers.



RECEIVER TUBES

Powder coated black finish. Welded. Fits 2" receivers.

Part#	Length
11770	6"
11771	12"
11772	18"
11773	24"
11774	36"
11775	48"



PINTLE HOOKS

Solid forged steel construction. Black enamel painted finish.

Pintle Hooks

All bolts made from heat treated alloy steel. 4-1/4" x 3-1/4" base plate.

Part#	Capacity	TW (lb)	GTW (lb)
11618	5 Tons	2,000 lb	10,000 lb
11620	10 Tons	4,000 lb	20,000 lb
11619	15 Tons	6,000 lb	30,000 lb
11619	15 Tons	6,000 lb	30,000 lb
11622	30 Tons	14,000 lb	60,000 lb



Pintle Hooks - Solid Shank

Fits 2" receivers.

Part#	TW (lb)	Hook Cap. (lb)
11718	2,000 lb	10,000 lb
11719	2,000 lb	20,000 lb
11720	2,000 lb	30,000 lb





Pintle Mounts

For 2" receivers. Converts receivers for use with pintle type trailers quickly and easily. Provides mounting for both ball and pintle hooks. Black powder coat finish.

Part#	Description	TW (lb)	GTW (lb)	# of Holes	Position (Pairs)
11610	7-5/16" x 5"	1,000 lb	10,000 lb	8	4th
11630	12-1/2" x 5"	1,000 lb	10,000 lb	14	7th



Combination Pintle Hooks

Fits 2" receivers

Part#	Ball Size	Ball Cap.(lb)	TW (lb)	GTW (lb)	Replacement Ball Part#'s
11616	2"	7,000 lb	3,000 lb	16,000 lb	11632
11617	2-5/16"	12,000 lb	3,000 lb	16,000 lb	11633



Combination Pintle Hooks - 1-Piece, Solid Shank

Part#	Ball Size	Ball Cap.(lb)	TW (lb)	GTW (lb)	Shank	Replacement Ball Part#'s
11715	1-7/8"	2,000 lb	1,200 lb	12,000 lb	2"	11631
11716	2"	7,000 lb	1,200 lb	12,000 lb	2"	11632
11717	2-5/16"	12,000 lb	1,200 lb	12,000 lb	2"	11633

TOWING RINGS

Tow rings eliminate the need for a swivel-type pintle hook in demanding off-road situations. Forged steel, black powder coated finish.



Part#	Description	Tow Rating
11634	Standard fixed, 2-1/2" ring diameter, 3-1/4" shank length, 1-1/2" shank diameter	15,000 lb
11635	3 position adjustable lunette ring, forged ring 6" outside diameter, 2-3/4" inside diameter, 3-5/8" outside bracket width, 3" inside bracket width, 1,800 lb. vertical load.	12,000 lb
11636	2-1/2" diameter ring with square 6" base plate, 5/8" diameter mounting holes, 4,000 lb. vertical load.	42,000 lb

LED TRAILER TOWING KITS

Stay safe with Dynaline's LED trailer light kits, boat trailer lights and RV trailer lighting.

LED Magnetic Towing Light Kit

Ideal for situations requiring temporary lighting.

<i>Part#</i>	<i>Description</i>	<i>Contents</i>
11978	LED Magnetic Towing Light Kit with 20 feet of wiring with 4-pole flat adapter.	Includes 2 round magnetic LED lights, mounting hardware and connectors.



RV, Marine & Utility LED Lighting Kit (Over 80" Submersible)

<i>Part#</i>	<i>Description</i>	<i>Contents</i>
11980	LED Trailer Lighting Kit. Over 80" submersible, 4-pole flat connector.	Includes 2 rectangular LED lights, mounting hardware and connectors.



TOWING MIRRORS

- Quick and simple to fit
- Extends field of vision for trailer towing
- Does not obstruct view of existing mirror
- Double pivoting arms attach to most mirrors
- No-Mar flexible rubber straps protect vehicle finish and ensure snug, vibration free fit
- No tools required!



Clip-On Towing Mirror

Suits most passenger car side mirrors.

<i>Part#</i>	<i>Dimensions</i>	<i>Description:</i>
17715	Mirror size: 190 mm W x 128 mm H (7-1/2" W x 5" H)	Arms adjust to fit mirror sizes 100 mm H to 150 mm H (4" H to 6" H)



DUAL MIRROR

Dual Clip-On Towing Mirror

Suits most passenger car side mirrors. Converts outer mirror for wide-angle view.

<i>Part#</i>	<i>Dimensions</i>	<i>Description:</i>
17717	Mirror size: 190 mm W x 140 mm H (7-1/2" W x 5-1/2" H)	Arms adjust to fit mirror sizes 115 mm H to 190 mm H (4-1/2" H to 7-1/2" H)



NO TOOLS REQUIRED

Deluxe Door Mount Towing Mirror

Easy installation • Suitable for towing trailers, campers, boats, etc. • Mounts onto door • Extra large stainless steel mirror head • No-Mar flexible rubber straps protect vehicle finish and ensure snug, vibration free fit • No tools required!

<i>Part#</i>	<i>Dimensions</i>	<i>Description:</i>
17722	Mirror size: 220 mm W x 145 MM H (8-5/8" W x 5-3/4" H)	Frame extends from 330 mm to 470 mm (13" to 18-1/2")



Rubber pad protects vehicle's finish



TRAILER CONNECTORS

Trailer connectors are an essential component for connecting power between your vehicle and trailer providing lights and brake functionalities.

2 Way Flat Connector

Part#	Description
27002	2-pole flat connectors. 12" 18 ga. white & yellow wires.



4 Pole Flat Connectors

Part#	Description
27004	4-pole flat wiring harness. 18 ga. wire - 12" male, 48" female, 18" ground.
27006	4-pole flat wiring harness. 12" 18 ga. wire.
27008	4-way flat wiring harness. 25 ft. 3-wire bonded loop with ground wire. 18 ft. male end, 5 ft. female end. 5 ft. brown extension wire included.

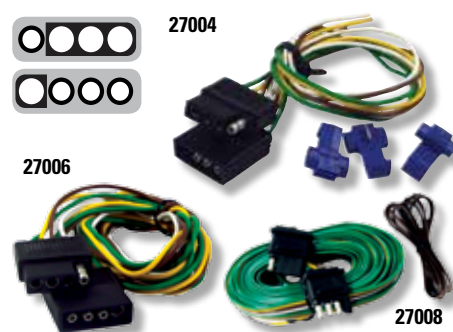

4 Pole Flat Loop Trailer Connector - Heavy Duty

Part#	Description
27010	4-pole flat loop. Heavy duty. 48" 18 ga. wires.



4 Pole Round Plug & Socket

Part#	Description
27015	Die cast, chrome plated housing. Trailer and Vehicle side.



5 Pole Flat Connectors

Part#	Description
27020	Male connector plug. Comes with 48" of 18 gauge wire.
27022	Female connector socket. Comes with 48" of 18 gauge wire.

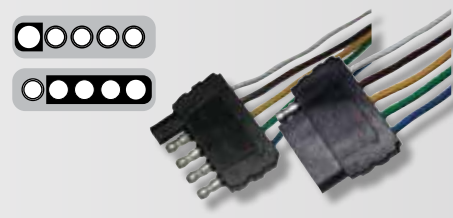

5 Pole Flat Connector- Heavy Duty

Part#	Description
27024	5-pole heavy duty connector loop. 48" 18 ga. wires.





6 Way Round Plug & Socket

Part#	Description:
27030	6-way round plug & socket. Heavy duty die cast housing.
27034	6-pole round socket with cover, with heavy duty die cast housing, vehicle side.
27036	6-pole round plug. Heavy duty die cast housing, trailer side.

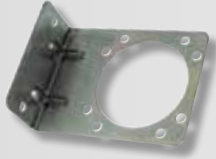

Mounting Bracket For 7 Way Trailer Connectors

Part#	Description:
27040	Zinc plated.



7 Way Socket

Part#	Description:
27042	7-way blade socket with cover. Zinc plated metal housing. Vehicle side.



7 Way Blade Plug

Part#	Description:
27044	7-way blade blade plug. Zinc plated metal housing. Trailer side.



7 Way Plug And Socket

Part#	Description:
27046	7-way blade. With cover, ABS housing with red reflector. Trailer and vehicle side.



7 Way Socket

Part#	Description:
27048	7-way blade socket. Plastic housing with red reflector. Vehicle side.



7 Way Plug

Part#	Description:
27050	7-way blade flat plug. Plastic housing. Trailer side.



7 Way Socket / 4-Way Plug Set

Part#	Description:
27052	7-way blade socket with cover. 4-way flat plug & Direct wiring. Vehicle side.

7 Way Socket Led & 4-Way Plug With LEDs

<i>Part#</i>	<i>Description</i>
27054	7-way pre-wired blade socket with cover. 4-way flat plug. 6 LED indicator. Vehicle side.
27056	27054 plus Mounting Kit.



7 Way Plug - Heavy Duty

<i>Part#</i>	<i>Description</i>
27060	7-pole round plug. Heavy duty die cast housing. Trailer side.



7 Way Socket - Heavy Duty

<i>Part#</i>	<i>Description</i>
27062	7 pole round socket with cover. Vehicle side.



7 Way Plug

<i>Part#</i>	<i>Description</i>
27064	7-pole round plug. Nylon with fiberglass housing. Trailer side.



7 Way Socket

<i>Part#</i>	<i>Description</i>
27066	7-pole round socket with cover. Nylon with fiberglass housing. Vehicle side.



7 Way Socket - Heavy Duty

<i>Part#</i>	<i>Description</i>
27068	7-pole round heavy duty socket. 3 hole mounting.



6 Way Socket, 4 Way Plug With LEDs (Adapter)

<i>Part#</i>	<i>Description:</i>
27070	6-pole pre-wired round socket with cover. 4-way pre-wired flat connectors. 5-LED indicator in socket. Direct wiring. Vehicle side.
27075	#27070 Plus mounting kit.





4 Way In-Line Adapter

Part#

Description:

27076

Trailer Connector Set, 4-way in-line adapter with cover.



27078



27078



27084



27086

27080



27084



27082

27088



27088

Trailer Connector Adapters

Part#

Description:

27078

6-way round to 4-way flat.

27080

7-pole round to 4-way flat.

27082

7-way blade to 6-way round. Center pin auxiliary.

27084

7-way blade to 4-way flat.

27086

7-way blade plug to 6-way round socket, 5-way flat, and 4-way flat.

27088

7-pole blade plug to 7-pole round socket. Heavy duty.



4 Way Flat Connector (Adapter)

Part#

Description:

Content

27090

Tail Light Adapter. 4 way 3 amp flat connector with cover.

Supplied with 18 gauge bonded wiring.

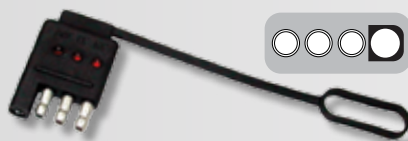

4 Way Flat Tester With LEDs

Part#

Description:

27092

4-way flat tester with 3 LEDs indicator and ring.

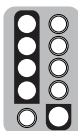

4 Way And 5 Way Flat Tester With LEDs

Part#

Description

27093

4-way and 5-way flat tester with 4 LEDs indicator and cover.



7 Way Blade Tester With LEDs

Part#

Description

27096

7-way blade tester with 6 LEDs indicator.



Breakaway Switch With Lanyard

Part#

Description

27098

With 4 ft. of 16 gauge wire. Metal bracket included.

BRAKE CONTROLLERS - Featuring Quik-Connect™ Installation

An electric trailer brake controller device installs in the cab of your tow vehicle and activates your trailer's electric or electric-over-hydraulic brakes when you apply them in your tow vehicle.



Hayes

www.hayesbc.com

TOW-PRO

Synchronizer Brake Controller

The Synchronizer is a brake controller for single and tandem axle trailers equipped with electric brakes. It modulates and controls the current from the battery to the trailer brakes. The longer the brake pedal is depressed the greater the current delivered to the trailer brakes until the preset brake power setting is reached. Recommended for light duty trailers with 2 or 4 electric brakes, time based. 3 year warranty.



Part#

Description

81725

Time based control for 2/4 brakes.

Energize III Brake Controller

Energize III all electronic brake controller features a patented sensing device that automatically monitors and measures tow vehicle deceleration and applies the trailer brakes in direct proportion. It reacts instantly to any change in brake pedal pressure and ensures controlled, smooth stops. Trailer and tow vehicle stoplights operate automatically when the manual lever or trailer brakes are applied. Recommended for medium / heavy duty trailers with 2 or 4 electric trailer brakes. 5 year warranty.



Part#

Description

81741B

Proportional control, 2/4 brake.

Genesis Brake Controller

"Intelligent" controller - The Genesis lets you apply full power in emergency stopping situations. The three-axis accelerometer technology automatically levels and senses the rate of deceleration. For 2, 4, 6 or 8 electric brakes, adjustable minimum power. Lifetime warranty.



Part#

Description:

81790

With U-bracket mount.

Air Actuated Brake Controller

The air actuated electric trailer brake controller provides smooth brake actuation. The electric brakes on the trailer operates off the air brake system of the tow vehicle. When the brake pedal is depressed, the application of the electric trailer brakes is proportional to the vehicle's brake pedal pressure. For 12 volt negative ground vehicles only. Features mounting bracket and indicator light.

- Operates 2, 4 or 6 electric trailer brakes. Can provide 18-amp output.
- Automatic or manual operation of the trailer electric brakes
- Red indicator light shows braking system intensity and proper function
- Compact case design with black textured surface
- Mounting bracket and screws included for easy installation
- One year limited warranty



Part#

Description:

100400-B

Air actuated electric trailer brake controller.



Hayes

WIRING HARNESSSES

Quick-Connect™ / Vehicle Reference Chart

Make/ Model	Year	Position	Part#
Buick			
Enclave	08-13	BP1	81789HBC
Cadillac			
Escalade all, including EXT	02	BP1	81781HBC
Escalade all, including EXT & ESV	03-06	BP1	81780HBC
Chevrolet			
Avalanche	02	BP1	81781HBC
Avalanche	03-06	BP1	81780HBC
Pickup, Silverado	99-02	BP1	81781HBC
Pickup, Silverado	03-06	BP1	81780HBC
Pickup, Silverado Classic Only	07	BP1	81780HBC
Suburban	03-06	BP1	81780HBC
Suburban new body style	00-02	BP1	81781HBC
Tahoe	03-06	BP1	81780HBC
Tahoe new body style	00-02	BP1	81781HBC
Traverse	09-12	BP1	81789HBC
Chrysler			
Aspen with factory tow package	07-09	BP2	81782HBC
Dodge			
Dakota Pickup with factory tow package	97-10	BP2	81782HBC
Durango with factory tow package	98-09	BP2	81782HBC
Pickup, Ram full size, 1500 only, all models	95-09	BP2	81782HBC
Pickup, Ram full size, 2500 only, all models	95-09	BP2	81782HBC
Pickup, Ram full size, 3500 only, all models	95-09	BP2	81782HBC
Pickup, Ram full size, 1500 only, all models	10-12	BP2	81795HBC
Pickup, Ram full size, 2500 only, all models	10-12	BP2	81795HBC
Pickup, Ram full size, 3500 only, all models	10-12	BP2	81795HBC
Durango / Jeep Cherokee	11-12	BP2	81796HBC
Ford			
Bronco full size	94-96	BP3	81783HBC
Econoline van, full size	92-08	BP3	81783HBC
Econoline van, full size	09-13	BP7	81788HBC
Excursion	00-05	BP3	81783HBC
Expedition	97-13	BP3	81783HBC

Make/ Model	Year	Position	Part#
Ford			
Explorer with factory tow package	02-13	BP6	81783HBC
F-150	94-96	BP3	81783HBC
F-150 Flareside (New body style)	04-08	BP3	81783HBC
F-150 Flareside (New body style)	09-13	BP3	81794HBC
F-150 Flareside (New body style)	04-08	BP3	81783HBC
F-150 Flareside (New body style)	09-13	BP3	81794HBC
F-150 Light Duty Flareside	97-03	BP3	81783HBC
F-150 Light Duty Styleside	97-03	BP3	81783HBC
F-150 Light Duty Heritage Flareside (Old body style)	04	BP3	81783HBC
F-150 Light Duty Heritage Styleside (Old body style)	04	BP3	81783HBC
F-150 SuperCrew (New body style)	04-08	BP3	81783HBC
F-150 SuperCrew (New body style) w/5.5 & 6.5 ft. beds	09-13	BP3	81794HBC
F-250	94-96	BP3	81783HBC
F-250 Heavy Duty	97	BP3	81783HBC
F-250 Light Duty Styleside	97-99	BP3	81783HBC
F-250 Super Duty	99-04	BP3	81783HBC
F-250 Super Duty	05-07	BP5	81784HBC
F-250 Super Duty	08-13	BP3	81788HBC
F-350	94-96	BP3	81783HBC
F-350 Heavy Duty	97	BP3	81783HBC
F-350 Super Duty	99-04	BP3	81783HBC
F-350 Super Duty	05-07	BP5	81784HBC
F-350 Super Duty	08-13	BP3	81788-HBC
F-350 Super Duty Cab & Chassis	05-07	BP5	81784HBC
F-350 Super Duty Cab & Chassis	08-13	BP3	81788HBC
F-450 Super Duty	08-13	BP3	81788HBC
F-450 Super Duty Cab & Chassis	99-04	BP3	81783HBC
F-450 Super Duty Cab & Chassis	05-07	BP5	81784HBC
F-450 Super Duty Cab & Chassis	08-13	BP3	81788HBC

Cont. next page

WIRING HARNESSES

Quick-Connect™ / Vehicle Reference Chart - Continued

<i>Make/ Model</i>	<i>Year</i>	<i>Position</i>	<i>Part#</i>	<i>Make/ Model</i>	<i>Year</i>	<i>Position</i>	<i>Part#</i>
Ford				Infiniti			
F-550 Super Duty Cab & Chassis	99-04	BP3	81783HBC	QX56	04-13	BP1	81786HBC
F-550 Super Duty Cab & Chassis	05-07	BP5	81784HBC	Land Rover			
F-550 Super Duty Cab & Chassis	08-13	BP3	81788HBC	LR3	05-09	BP3	81783HBC
Flex, with factory tow package	09-13	BP2	81783HBC	LR4	10	BP3	81783-HBC
Windstar, with factory tow package	95-03	BP3	81783HBC	Range Rover Inc. Sport	05-13	BP3	81783HBC
GMC				Lexus			
Pickup, Sierra	99-02	BP1	81781HBC	GX470	03-13	BP3	81785HBC
Pickup, Sierra	03-06	BP1	81780HBC	LX470	03-07	BP3	81785HBC
Pickup, Sierra Classic only	07	BP1	81780HBC	LX570	08-13	BP3	81785HBC
Yukon	03-06	BP1	81780HBC	Lincoln			
Yukon (New body style) with amber turn signals	00-02	BP1	81781HBC	Mark LT	06-08	BP3	81783HBC
Yukon Denali	03-06	BP1	81780HBC	MKT, with factory tow package	10	BP1	81783HBC
Yukon Denali (New body style) with amber turn signals	01-02	BP1	81781HBC	Navigator	98-10	BP3	81783HBC
Yukon XL	00-02	BP1	81781HBC	Mercury			
Yukon XL	03-06	BP1	81780HBC	Mountaineer with factory tow package	02-13	BP6	81783HBC
Yukon XL Denali	01-02	BP1	81781HBC	Nissan			
Yukon XL Denali	03-06	BP1	81780HBC	Armada	04-13	BP1	81786HBC
Honda				Frontier Pickup	05-13	BP3	81786HBC
Pilot, with factory tow package	09-13	BP1	81787HBC	Pathfinder	05-13	BP3	81786HBC
Ridgeline, with factory tow package	06-13	BP1	81787HBC	Titan Pickup	04-13	BP1	81786HBC
Hummer				Toyota			
H2	03-07	BP1	81780HBC	4-Runner	03-09	BP4	81785HBC
H2 SUT	05-07	BP1	81780HBC	LandCruiser	03-13	BP3	81785HBC
				Sequoia	03-13	BP4	81785HBC
				Tacoma Pickup	07-13	BP4	81785HBC
				Tundra	03-13	BP4	81785HBC

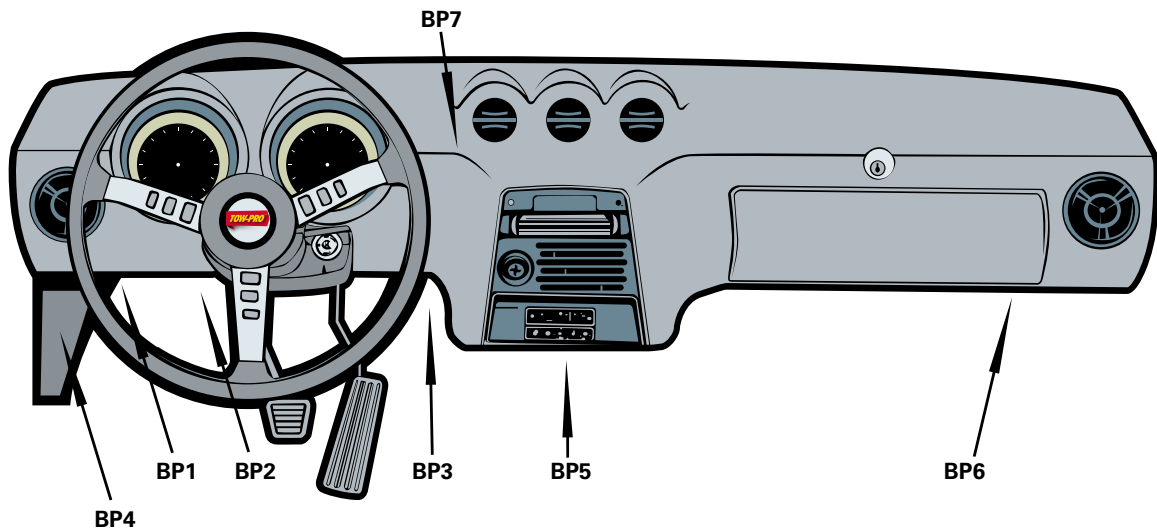

Position Legend

- BP-1 Under or behind dash, to the left or right of the emergency brake pedal.
 BP-2 Under or behind dash to the left of the steering column and brake pedal.
 BP-3 Under or behind dash to the right of the steering column and brake pedal.
 BP-4 Kick panel area, on the Driver's side.
 BP-5 Under or behind dash, behind the center console.
 BP-6 Under or behind dash on the passenger side, near glovebox.
 BP-7 Centered behind dash between the steering column and the radio.

WIRING HARNESSES

Quik-Connect™ OEM

Part#	Description
81780HBC	For GM, 2003-2006
81782HBC	For Dodge / Chrysler, 1995 - 2010
81783HBC	For Ford, 1994 - current
81785HBC	For Toyota & Lexus, 2003 - current
81786HBC	For Nissan, 2004 - current
81788HBC	For Ford HD, 2008 - current
81789HBC	HBCC Universal - Buick, Chev, 2008 - current
81794HBC	For Ford F-150 Flareside, 2009 - current



81780HBC



81782HBC



81785HBC



81786HBC



81788HBC



81789HBC

POWER JACK

- 3500 lb of lifting power!
- Tracks 10" in 60 seconds
- 12 volt DC powered with manual crank over-ride
- Allows quick break-away from coupler
- Water resistant enclosed motor
- Auto shut-off
- Low noise level during operation
- Fits 2-1/4" mounting holes
- Full 18" stroke
- Durable black powder coated finish
- Hardened steel gears
- LED light, easy night time hookups
- Oversize 5-1/2" diameter foot pad
- Weather sealed switch
- Built-in level
- Black plastic cover
- Outer tube diameter 2-1/4"
- Power cord length: 6' of #10 gauge wire

Part#	Vertical Load	Support Capacity	Retracted Height	Lift	Extended Height
52703	3,500 lb	5,250 lb	31-3/8"	18"	49-3/8"



"SWING-WAY" JACKS WITH CASTER WHEELS

Black powder coated finish. Perfect for use on tow trailers of various coupler heights. Heavy duty swivel mechanism swings and locks jack to transport position. Pull-type locking pin secures jack into load-bearing position. Supplied with bolt reinforced caster and mounting bracket. Fits tongues up to 3" x 5".

Part#	Support Capacity	Maximum Lift Capacity	Caster Wheel	Lift	Bracket Height	Retracted Height	Extended Height
11466	1,600 lb	1,200 lb	6"	10"	12-3/4"	23-1/4"	33-1/4"
11477	2,000 lb	1,500 lb	8"	10"	12-3/4"	25-1/2"	35-1/2"



SIDE WIND IMPLEMENT JACK WITH CASTER WHEELS

Weld on bracket. Black enamel finish. Poly caster wheel.

Part#	Support Capacity	Maximum Lift Capacity	Caster Wheel	Lift	Bracket Height	Retracted Height	Extended Height
78055	2,000 lb	1,200 lb	6"	15"	16-1/4"	23-1/4"	38-1/4"
No Caster	6,000 lb	5,000 lb					

Part# 78055-1
Replacement wheel for Part# 78055

All specifications for jacks are in accordance with the ASABE S 485 standards



A-FRAME JACKS

Heavy duty round tube with slotted universal-fit triangular bracket for easy bolt mounting or welding to A-Frame type trailer couplers. Supplied with detachable 6" reinforced poly-carbonate caster. 3-bolt bracket type. Mounting bolts included. Black enamel finish. Poly caster wheels.



Top Wind With Wheel

Part#	Support Capacity	Maximum Lift Capacity	Caster Wheel	Lift	Bracket Height	Retracted Height	Extended Height	Handle
11463	2,000 lb	1,200 lb	6"	15"	8-1/2"	20"	35"	Knob
11465	2,000 lb	1,200 lb	6"	15"	8"	20"	35"	Grip
No Caster	6,000 lb	5,000 lb						



Side Wind With Wheel

Part#	Support Capacity	Maximum Lift Capacity	Caster Wheel	Lift	Bracket Height	Retracted Height	Extended Height
11467	2,000 lb	1,200 lb	6"	15"	9-1/2"	23-1/2"	38-1/2"
No Caster	2,800 lb	2,000 lb					



Top Wind Without Base or Wheel

Part#	Support Capacity	Maximum Lift Capacity	Lift	Bracket Height	Retracted Height	Extended Height
11492	6,000 lb	5,000 lb	15"	8-1/2"	20"	35"
11493	6,000 lb	5,000 lb	15"	10"	21"	36"
11492-1	Base for 11492 & 11493					



Side Wind Without Wheel

Part#	Support Capacity	Maximum Lift Capacity	Lift	Bracket Height	Retracted Height	Extended Height
11484	2,800 lb	2,000 lb	15"	9"	24"	39"



Square Tube A-Frame Jack

Outer tube: 57mm x 50mm. Base: 96mm x 196mm. Weight: 9.2 kg.

Part#	Support Capacity	Maximum Lift Capacity	Type	Travel	Bracket Height	Retracted Height	Extended Height
11486	6,500 lb	5,000 lb	Side Wind	15" + 13"	7-1/2"	24-1/2"	37-1/2"

ROUND TUBE IMPLEMENT JACKS

Robust internal gear mechanism and heavy duty rolled threads for smooth operation and dependability. 4-position mounting tube, lock-pin and handle. Black enamel painted finish.

Top Wind Tube Mount

Part#	Support Capacity	Maximum Lift Capacity	Lift	Bracket Height	Bracket Type	Retracted Height	Extended Height
11468	6,500 lb	5,000 lb	10"	10"	Pipe	15"	25"
11469	6,500 lb	5,000 lb	15"	15"	Pipe	20-1/4"	35-1/4"
11485	2,800 lb	2,000 lb	10"	10"	Pipe	15"	25"
11497	2,800 lb	2,000 lb	15"	15"	Pipe	20-1/4"	35-1/4"
11498	8,400 lb	7,000 lb	10"	10"	Pipe	16"	26"
11511	8,400 lb	7,000 lb	15"	15"	Pipe	20-1/4"	35-1/4"



Top Wind Swivel Bracket Mount

Part#	Support Capacity	Maximum Lift Capacity	Lift	Bracket Height	Bracket Type	Retracted Height	Extended Height
11470	2,800 lb	2,000 lb	10"	8-1/2"	Flange	15"	25"
11471	2,800 lb	2,000 lb	15"	13-1/4"	Flange	20"	35"



Side Wind Tube Mount (7-1/2" x 4" Base Plate)

Part#	Support Capacity	Maximum Lift Capacity	Lift	Bracket Height	Bracket Type	Retracted Height	Extended Height
11472	6,500 lb.	5,000 lb	15"	14"	Pipe	22"	37"
11473	6,500 lb	5,000 lb	10"	9"	Pipe	16-1/2"	26-1/2"
11512	2,800 lb	2,000 lb	10"	9"	Pipe	16-1/2"	26-1/2"



Side Wind Tube Mount (8" x 6" Base Plate)

Part#	Support Capacity	Maximum Lift Capacity	Lift	Bracket Height	Bracket Type	Retracted Height	Extended Height
11474	8,400 lb	7,000 lb	10"	9"	Pipe	17"	27"
11475	8,400 lb	7,000 lb	15"	14-1/4"	Pipe	22-1/2"	37-1/2"
11479	6,500 lb	5,000 lb	15"	15"	Pipe	22-1/2"	37-1/2"



SQUARE TUBE IMPLEMENT JACKS

Robust internal gear mechanism & heavy duty rolled threads for smooth operation.
Equipped with removable cover, grease fittings, 4-position mounting tube and lock-pin.
Black enamel painted finish.



Top Wind Tube Mount

Part#	Support Capacity	Maximum Lift Capacity	Lift	Bracket Height	Bracket Type	Retracted Height	Extended Height
11520	2,800 lb	2,000 lb	10"	10"	Pipe	19"	29"
11252	2,800 lb	2,000 lb	15"	10"	Pipe	23"	38"
11526	2,800 lb	2,000 lb	15"	15"	Pipe	21"	36"
11530	6,000 lb	5,000 lb	10"	11"	Pipe	19"	29"
11535	6,000 lb	5,000 lb	15"	15-3/4"	Pipe	22"	37"



Side Wind Tube Mount

Part#	Support Capacity	Maximum Lift Capacity	Lift	Bracket Height	Bracket Type	Retracted Height	Extended Height
11510	2,800 lb	2,000 lb	10"	9"	Pipe	19-1/2"	29-1/2"
11515	2,800 lb	2,000 lb	15"	15"	Pipe	23-1/2"	38-1/2"
11540	6,500 lb	6,000 lb	10"	9"	Pipe	17"	27"



Square Tube Trailer Jack

Heavy duty 2-1/4" square tube "weld-on" construction designed for reliability and durability.
Features grease fitting for lubrication of mechanism. Black enamel painted finish.

Part#	Support Capacity	Maximum Lift Capacity	Lift	Type	Retracted Height	Extended Height
11480	6,500 lb	5,000 lb	15"	Top Wind	22"	37"



Side Wind Tube Mount "Drop-leg" Jack

Robust 2-1/4" square tube. Drop leg adjusts 15" in addition to lift.
Features grease fitting for lubrication of mechanism. Black enamel painted finish.

Part#	Support Capacity	Maximum Lift Capacity	Type	Lift	Total Travel	Retracted Height	Extended Height
11545	6,500 lb	6,000 lb	Side Wind	16" + 15"	31"	24-1/2"	50-1/2"



Square Tube "Drop Legs" Jack

Robust 2-1/2" square tube "weld-on" construction. Drop leg adjusts 13" in addition to lift.
Features grease fitting for lubrication of mechanism. Black enamel painted finish.

Part#	Support Capacity	Maximum Lift Capacity	Type	Lift	Total Travel	Retracted Height	Extended Height
11487	8,000 lb	7,000 lb	Top Wind	15" + 13"	28"	22"	50"
11488	8,000 lb	7,000 lb	Side Wind	15" + 13"	28"	24-1/2"	52-1/2"

Square Tube "Simol" Type Jack

Heavy 3" square tube construction. 8-1/2" handle length. Round base plate is 8-1/2" in diameter. Weighs 34 lb

Part#	Support Capacity	Maximum Lift Capacity	Type	Bracket Height	Total Travel	Retracted Height	Extended Height
11547	9,000 lb	8,000 lb	Side Wind	11"	12.2"	24"	35"



Square Tube "Drop Legs" Jacks - Heavy Duty

Heavy duty 4" square tube "weld-on" construction. Drop leg has 5 position holes and adjusts 13" in addition to lift. Features grease fittings for lubrication of mechanism. Black finish.

Part#	Support Capacity	Maximum Lift Capacity	Type	Lift	Total Travel	Drop Leg Pin Location	Retracted Height	Extended Height
11490	12,000 lb	10,000 lb	Side Wind	12-1/2"	25-1/2"	Side	28-1/2"	54"
11495	12,000 lb	10,000 lb	Top Wind	12-1/2"	25-1/2"	--	23-1/2"	49"



Square Tube Jack - Heavy Duty

Heavy duty 4" square tube "weld-on" construction. Features grease fittings for lubrication of mechanism. Black finish. No drop leg.

Part#	Support Capacity	Maximum Lift Capacity	Type	Lift	Retracted Height	Extended Height
11494	12,000 lb	10,000 lb	Side Wind	12-1/2"	28"	40-1/2"



Levelling Scissor Jacks

Used for stabilizing and levelling 5th wheels and travel trailers. Sturdy steel construction. Designed for today's larger and heavier units. Black finish. Permanently mounted and conveniently concealed when not in use. Easy to install. Comes with wrench.

Part#	Support Capacity	Maximum Lift Capacity
11890	2,500 lb	4" to 24"
11891	5,000 lb	4" to 24"
11893	5,000 lb	5" to 30"



Stabilizer Jack

Used for stabilizing travel trailers, camper trailers and boat trailers. 4" x 3-3/8" base plate.

Part#	Lift Capacity	Retracted Height	Extended Height
11895	1,000 lb	11.5"	18"



JACK PARTS AND ACCESSORIES

Jack Replacement Parts And Accessories



<i>Part#</i>	<i>Description</i>
11477-1	Plastic cap - Fits Jack #11477
11488-1	Replacement cap - Fits Jack #11488
11491	Side Wind Jack Handle - Fits Jack #11488
11500	Mounting Tube, External, Large - 2-1/2" Inside Diameter
11501	Mounting Tube, Internal, Small - 2" Outside Diameter
11513	Weld-On Mounting Bracket
11502	Top Wind Handle
11505	Side Wind Handle
11509	Bushing for Jack Handle
66469	Quick Pin for Implement Jacks - 5/8" Pin Diameter, 3-1/8" Usable Length

Fifth Wheel King Pin Stabilizer

Stabilizes motion of unhitched trailer or RV. Threaded hitch cap allows for height adjustment. Includes chain with inserts. Folds for storage. Durable steel construction. King Pin height adjusts from 35" to 55".

<i>Part#</i>	<i>Support Capacity</i>	<i>Footplate Dimensions</i>	<i>Weight</i>
11794	5,000 lb	5" x 5-1/2"	23 lb



**Adjusts from
35" to 55"**

Trailer Wheels - High Speed

Eight-spoke rim, powder-coated for increased durability and long lasting finish. Yellow River Tires feature double steel belting and full nylon plies for increased strength and product life.



80124

<i>Part#</i>	<i>Wheel Size</i>	<i>Tire Size</i>	<i>Bolt Pattern</i>	<i>Pilot Diameter</i>	<i>Capacity</i>	<i>Load Range</i>
80120	12" x 4"	4.8" x 12"	4	2.83"	585 lb	C
80124	12" x 4"	5.3" x 12"	5	2.83"	1,047 lb	C
80128	13" x 4-1/2"	ST175/80 D13	5	3.19"	1,477 lb	D
80130	14" x 5-1/2"	ST205/75 D14	5	3.19"	1,764 lb	C
80132	15" x 5 -1/2"	ST205/75 D15	5	3.19"	1820 lb	C

Wheel Locks

Adjustable slide-lock for wheels. Fits multiple tire sizes. Weather proof locks with 2 keys.

NEW

<i>Part#</i>	<i>Description</i>	<i>Packaging</i>
65088	Middle Duty. Fits 7" to 11" width tires	Double blister

<i>Part#</i>	<i>Description</i>	<i>Packaging</i>
65089	Heavy Duty. Fits 7" to 11" width tires	Colour box

<i>Part#</i>	<i>Description</i>	<i>Packaging</i>
65090	Super Heavy duty. Fits 13" to 16" Rims. Fits tires up to 28".Diameter X 9" width	Colour box



Wheel Chocks

Rubber wheel chock for trailers, cars or other small vehicles. Non-slip surface provides superior traction.

<i>Part#</i>	<i>Size</i>
11984	7-1/2" x 6" x 3-3/4"
11985	10-5/8" x 7" x 4-1/2"

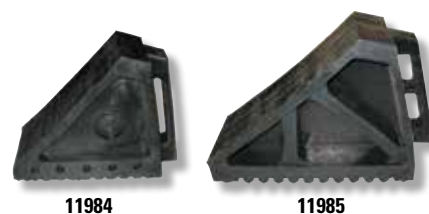

Made from rubber compound with reinforced nylon fiber. Ideal for trailers and heavy loaded vehicles. Eyebolt for easy handling.

<i>Part#</i>	<i>Size</i>
11986	8" x 6" x 10"



Yellow plastic wheel chock. Comes packaged in colour box. 2 wheel chocks per box.

<i>Part#</i>	<i>Size</i>
11988	8" x 5" x 4-1/4"



Mud Flaps

Sold separately. Each made of heavy rubber.

NEW

<i>Part#</i>	<i>Size</i>	<i>Thickness</i>	<i>Mounting Head</i>
11981	24" x 24"	1/4"	5/16"
11982	24" x 30"	1/4"	5/16"
11991	24" x 24"	3/8"	7/16"
11992	24" x 30"	7/16"	7/16"
11993	24" x 36"	7/16"	7/16"



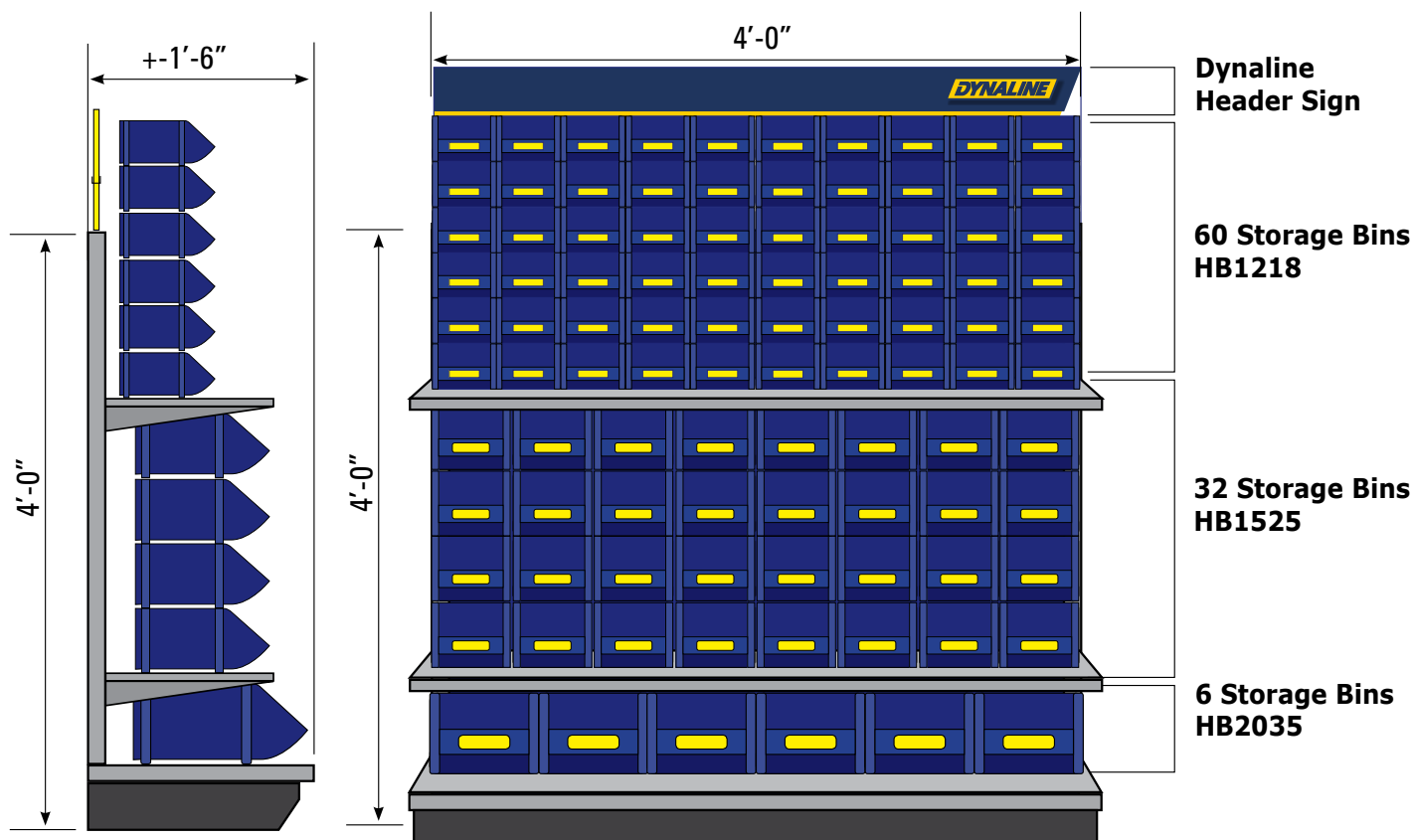

SIDE VIEW

FRONT VIEW

Storage Bin Plan-O-Gram

- Storage Bins to accommodate bulk items
- Supplied with stacking pegs & labels
- Custom Plan-O-Gram with header



**Caster Wheels
Plan-O-Gram**

DYNALINE

Better products for all.

Chain

Chain Fittings

Eyebolts

Hitch Pin

Links

Pulleys

Pins

Hooks

Snaps

Turnbuckles

U-Bolts



RIGGING & HARDWARE

Chain

Grade 70 & 30	1
Transport Chain Assemblies	3

Chain Fittings

Hooks	4
Grab Hooks	5
Swivel Hook	6
Safety Hooks	6
Hoist Hooks	6

Grade 80 Fittings

Links & Hooks	7
---------------------	---

Shackles

Screw Pin Commercial Grade, Stainless Steel and Chain Shackle	8
Bolt Type Shackle & Mid Links	9

Links

Cold Shuts, Swivels & Repair Links	10
Locks, Connecting, Quick Links & D-Rings ..	11

Small Diameter Cable (Aircraft Cable)

7x7 & 7x19 Construction	12
-------------------------------	----

Wire Rope

6x19 Fiber Core	12
-----------------------	----

Wire Rope Clips

Iron, Steel & Stainless Steel	13
-------------------------------------	----

Thimbles

Cable, Wire Rope & Heavy Duty Wire Rope Thimbles	14
---	----

Cable Stops

Aluminum & Dynapaks	15
---------------------------	----

Cable Sleeves

Aluminum & Dynapaks	15
---------------------------	----

Cable Cutters

Aluminum Forged	16
-----------------------	----

Swaggers

Bench & Hand Swaggers	16
-----------------------------	----

Tire Chain Hardware

Boomer, Clevis, Thumbscrew, C-Hooks & C-Links Tire Chain Pliers	16
--	----

Pulleys

Aluminum Die Cast Solid, Spoked & Variable Speed	17
Awning Die Cast Single & Double	17
Steel Pulley Blocks	18
Awning Replacement Sheaves	19
Deuer Type Swivel, Fixed & Hook	19
Heavy Duty Replacement Sheeves	20

General Hardware

Stake Rack Hooks & Eye	20
S-Hooks	20
Gate Hooks	20
Bronze Bushings	40
Cornice, Hooks, Eye Hooks, Lagscrew & Eyebolts Shoulder Eyebolts	22

U-Bolts

Round & Square	23
----------------------	----

Rings

Mounted, D-Rings & Heavy Duty D-Rings ...	24
Split Key, Harness & Welded Rings	24

Turnbuckles

Wire Formed Hook & Eye	24
Wire Formed Hook & Hook	25
Wire Formed Eye & Eye	25
Iron Hook & Eye	25
Forged Steel Hook & Hook	25
Forged Steel Hook & Eye	26
Forged Steel Eye & Eye	26
Forged Steel Jaw & Jaw	26

Snaps

Stainless Steel to Snap Links	27-31
-------------------------------------	-------

Farm Hardware

Weather Caps	32
Muffler Clamps	32
Stroke Control & Cylinder Pins	32-33
Tractor Drawbar Hooks	33
Straight Clevis	33
Steering Wheel Spinners	33
Safety & Quick Release Pins	34

Hitch Pins

High Strength	34
Fold Over with Chain	35
Grade 8	36
E-Grip	35
Forged Steel	37

Pins

Linch, Spring Lock, Quick, Round & Square .	37
Hair Pins - Internal & External	39

Lift Arm Bushings

Carbon Lift Arm Bushings	41
--------------------------------	----

Top Link Bushings

Carbon Steel Top Link Bushings	41
--------------------------------------	----

Top Links

Top Links	41
Repair Ends	41
Top Link Pins	41

Lift Arm Pins

Carbon Steel Lift Arm Pins	42
----------------------------------	----

Drawbars

3-Point Hitch Cross Drawbar	41
-----------------------------------	----

Ratchet Jack

Heavy Duty Ratchet Jack	41
-------------------------------	----

Manual Holders

Manual Holder	42
Security Tether	42

Not recommended for
overhead lifting



CHAIN

Grade 70 Transport Chain

Alloy steel, Class 7. A high strength, hardened and tempered chain made from alloy steel. For farm and truck load binding applications, towing, construction, and logging. Bright yellow dichromate finish. 4:1 design factor.

- Made to NACM specifications. Not to be used in overhead lifting applications.

PART#	CHAIN SIZE	INSIDE LENGTH	INSIDE WIDTH	W.L.L.	WT./100'	PAIL	DRUM
70020	1/4"	1.24"	0.38"	3,150 lb	74 lb	--	800'
70021	5/16"	1.29"	0.44"	4,700 lb	100 lb	--	550'
70022	3/8"	1.38"	0.55"	6,600 lb	145 lb	--	400'
70023	1/2"	1.79"	0.72"	11,300 lb	264 lb	--	200'
70024	1/4"	1.24"	0.38"	3,150 lb	74 lb	130'	--
70025	5/16"	1.29"	0.44"	4,700 lb	100 lb	90'	--
70026	3/8"	1.38"	0.55"	6,600 lb	145 lb	64'	--
70034	1/4"	1.24"	0.38"	3,150 lb	74 lb	65'	--
70035	5/16"	1.29"	0.44"	4,700 lb	100 lb	50'	--
70036	3/8"	1.38"	0.55"	6,600 lb	145 lb	45'	--



Grade 30 Proof Coil Chain

Low carbon steel, Class 3. A durable and economical utility chain manufactured from carbon steel. For pulling stumps, lashing cargo, logging, towing, mooring, pipeline installations, and truck tailgates.

- Zinc plated finish. Not to be used in overhead lifting applications.
- Made to NACM specifications.

PART#	CHAIN SIZE	INSIDE LENGTH	INSIDE WIDTH	W.L.L.	WT./100'	PAIL
70003	3/16"	0.98"	0.3"	800 lb	29 lb	250'
70004	1/4"	1.24"	0.38"	1,300 lb	52 lb	141'
70005-A	5/16"	1.29"	0.44"	1,900 lb	86 lb	62'
70005	5/16"	1.29"	0.44"	1,900 lb	86 lb	92'
70006	3/8"	1.38"	0.55"	2,650 lb	124 lb	63'
70007	3/16"	0.98"	0.3"	800 lb	29 lb	100'
70008	1/4"	1.24"	0.38"	1,300 lb	52 lb	65'
70013	3/16"	0.98"	0.3"	800 lb	29 lb	150'
70014	1/4"	1.24"	0.38"	1,300 lb	52 lb	100'
70015	5/16"	1.29"	0.44"	1,900 lb	86 lb	75'
70016	3/8"	1.38"	0.55"	2,650 lb	124 lb	45'



Coil Chain (Straight Link)

Low carbon steel, zinc plated. Used in guard chain applications, animal stakes, and farm implements.

PART#	TRADE SIZE	DIAMETER	INSIDE LENGTH	INSIDE WIDTH	W.L.L.	REEL LENGTH	WEIGHT/100'
70040	#4	0.12"	1.11"	0.21"	205 lb	100'	10 lb

Not recommended for overhead lifting

Passing Link Chain

Low carbon steel, zinc plated. General utility chain that resists kinks or knots.

PART#	TRADE SIZE	DIAMETER	INSIDE LENGTH	INSIDE WIDTH	W.L.L.	REEL LENGTH	WEIGHT/100'
70045	#2/0	0.19"	0.88"	0.47"	450 lb	120'	32 lb



Twist Link Machine Chain

Zinc plated. General utility chain that lays flat against a surface. Ideal for tie-down applications.

PART#	TRADE SIZE	DIAMETER	INSIDE LENGTH	INSIDE WIDTH	W.L.L.	REEL LENGTH	WEIGHT/100'
70050	#2/0	0.19"	0.73"	0.28"	520 lb	75'	34 lb
70051	#4	0.12"	0.52"	0.17"	200 lb	100'	13 lb



Double Loop Chain (Tenso Or Lion)

Zinc plated. For animal restraints, swings, door crash stops.

PART#	TRADE SIZE	DIAMETER	INSIDE LENGTH	INSIDE WIDTH	W.L.L.	REEL LENGTH	WEIGHT/100'
70060	#2/0	0.135"	1.82"	0.34"	255 lb	150'	17 lb
70063	#3	0.08"	1.10"	0.187"	90 lb	200'	6 lb



Double Loop Chain

Vinyl covered, blue or green.

PART#	TRADE SIZE	DIAMETER	INSIDE LENGTH	INSIDE WIDTH	W.L.L.	BOX LENGTH	WEIGHT/100'
70061	#1/0	0.12"	1.78"	0.312"	200 lb	100'	17 lb
70062	#2	0.091"	1.33"	0.167"	115 lb	125'	11 lb



Sash Chain

Zinc plated. Specifically designed to operate smoothly over pulleys. Ideal for hanging sash.

PART#	TRADE SIZE	DIAMETER	INSIDE LENGTH	INSIDE WIDTH	W.L.L.	REEL LENGTH	WEIGHT/100'
70075	#35	0.035"	0.57"	--	106 lb	100'	5.7 lb



Furnance Chain

Zinc plated. Light Duty, retainer chain.

PART#	TRADE SIZE	DIAMETER	INSIDE LENGTH	INSIDE WIDTH	W.L.L.	REEL LENGTH	WEIGHT/100'
70080	#1/0	0.022"	0.50"	0.199"	35 lb	250'	2.3 lb



Not recommended for
overhead lifting



NEW!



NEW!



Single Jack Chain

Zinc plated. For animal restraints, swings, door crash stops.

PART#	TRADE SIZE	DIAMETER	INSIDE LENGTH	W.L.L.	REEL LENGTH	WEIGHT/100'
70085	#10T	0.135"	0.093"	43 lb	150'	14 lb
70086	#12	0.105"	0.75"	29 lb	100'	8.5 lb
70087	#14	0.080"	0.63"	16 lb	200'	4.8 lb

Grade 70 - 5/16" Transport Chain Assemblies

Assembled with two plated alloy clevis grab hooks.

Comes with aluminum capacity tag.

Packaged in a plastic pail.

PART#	LENGTH	WLL	ULL
66051	16'	4,700lb	18,800lb
66052	20'	4,700lb	18,800lb

Grade 70 - 3/8" Transport Chain Assemblies

Assembled with two plated alloy clevis grab hooks.

Comes with aluminum capacity tag.

Packaged in a plastic pail.

PART#	LENGTH	WLL	ULL
66053	16'	6,600lb	26,400lb
66054	20'	6,600lb	26,400lb

HOOKS

Clevis Slip Hooks

Forged carbon steel. Clear zinc plated finish.
For use with Grade 30 & Grade 40 chains.

PART#	CHAIN DIAMETER	PIN	A	B	C	W.L.L.	U.L.L.
66115	1/4"	3/8"	7/16"	15/16"	4"	1,950 lb	7,800 lb
66116	5/16"	7/16"	1/2"	1-1/16"	4-1/2"	2,875 lb	11,500 lb
66117	3/8"	1/2"	9/16"	1-5/16"	5-3/8"	4,000 lb	16,000 lb
66118	7/16"	9/16"	5/8"	1-9/16"	6"	5,000 lb	20,000 lb
66119	1/2"	5/8"	3/4"	1-11/16"	6-3/4"	6,500 lb	26,000 lb

Eye Slip Hooks

Forged carbon steel. Clear zinc plated finish.
For use with Grade 30 & Grade 40 chains.

PART#	CHAIN DIAMETER	A	B	C	W.L.L.	U.L.L.
66129	1/4"	1/2"	15/16"	3-5/8"	1,950 lb	7,800 lb
66130	5/16"	5/8"	1-1/16"	4-3/16"	2,875 lb	11,500 lb
66131	3/8"	11/16"	1-5/16"	4-7/8"	4,000 lb	16,000 lb

Carbon Clevis Slip Hooks With Latch

Forged carbon steel. Clear zinc plated finish.
For use with Grade 30 & Grade 40 chains.

PART#	CHAIN DIAMETER	PIN	A	B	C	W.L.L.	U.L.L.
66070	1/4"	3/8"	7/16"	15/16"	4"	1,950 lb	7,800 lb
66071	5/16"	3/8"	1/2"	1-1/16"	4-1/2"	2,875 lb	11,000 lb
66072	3/8"	7/16"	5/8"	1-5/8"	5-1/4"	4,000 lb	16,000 lb

Not recommended for
overhead lifting

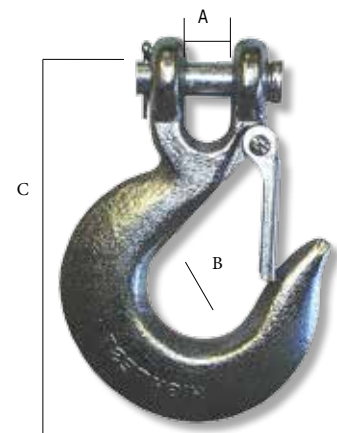
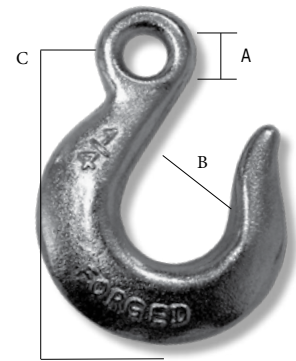
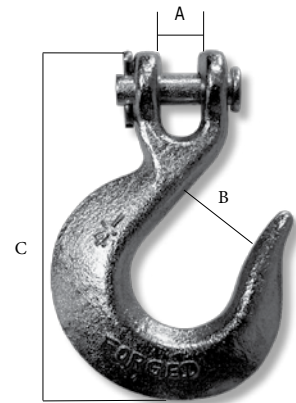

Not recommended for overhead lifting

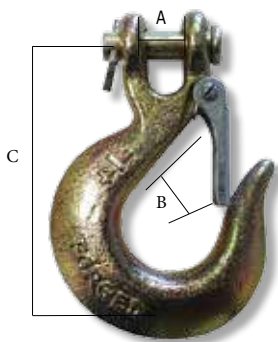

Alloy Clevis Slip Hooks With Latch

Forged alloy steel. For use with Grade 70 chain.
Yellow zinc dichromate plated finish.

PART#	CHAIN DIAMETER	PIN	A	B	C	W.L.L.	U.L.L.
66073	1/4"	3/8"	7/16"	15/16"	4"	2,750 lb	11,000 lb
66074	5/16"	7/16"	1/2"	1-1/16"	4-1/2"	4,300 lb	17,200 lb
66075	3/8"	7/16"	5/8"	1-5/8"	5-3/16"	5,250 lb	21,000 lb
66076	1/2"	5/8"	3/4"	1-3/4"	6-6/8"	9,000 lb	36,000 lb

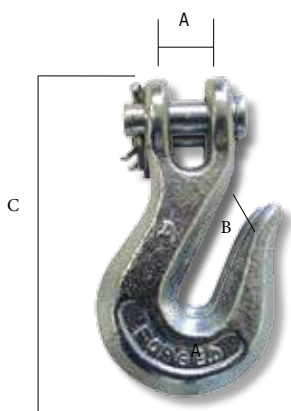

Clevis Grab Hooks

Forged carbon steel. Clear zinc plated finish.
For use with Grade 30 & Grade 40 chain.

PART#	CHAIN DIAMETER	PIN	A	B	C	W.L.L.	U.L.L.
66110	1/4"	3/8"	0.36"	13/32"	3-3/8"	2,600 lb	10,400 lb
66111	5/16"	7/16"	0.40"	7/16"	3-15/16"	3,900 lb	15,600 lb
66112	3/8"	1/2"	0.48"	1/2"	4-1/2"	5,400 lb	21,600 lb
66113	7/16"	9/16"	0.66"	9/16"	5"	7,200 lb	28,800 lb
66114	1/2"	5/8"	0.75"	5/8"	5-3/4"	9,200 lb	36,800 lb

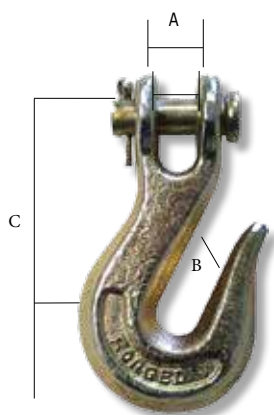

Alloy Clevis Grab Hooks

Forged alloy steel. For use with Grade 70 chain.
Yellow zinc dichromate plated finish.

PART#	CHAIN DIAMETER	PIN	A	B	C	W.L.L.	U.L.L.
66120	1/4"	3/8"	5/16"	13/32"	3-3/8"	3,600 lb	14,400 lb
66121	5/16"	7/16"	3/8"	7/16"	3-15/16"	5,400 lb	21,600 lb
66122	3/8"	15/32"	7/16"	1/2"	4-1/2"	7,500 lb	30,000 lb
66126	7/16"	9/16"	21/32"	9/16"	5"	10,000 lb	40,000 lb
66127	1/2"	5/8"	3/4"	21/32"	5-7/8"	12,750 lb	51,000 lb

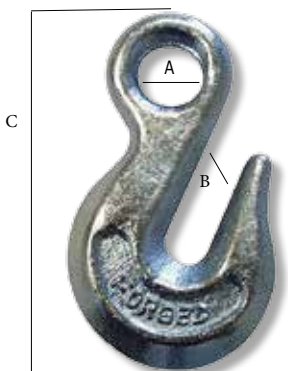

Eye Grab Hooks

Forged carbon steel. Clear zinc plated finish.
For use with Grade 30 chains.

PART#	CHAIN DIAMETER	A	B	C	W.L.L.	U.L.L.
66123	1/4"	1/2"	11/32"	3-1/16"	2,600 lb	10,400 lb
66124	5/16"	9/16"	7/16"	3-9/16"	3,900 lb	15,600 lb
66125	3/8"	13/16"	1/2"	4-1/4"	5,400 lb	21,600 lb

Alloy Clevis Hooks With Latch

Forged alloy steel. For use with Grade 70 chain.
Yellow zinc dichromate plated finish.

PART#	CHAIN DIAMETER	A	B	C	W.L.L.	U.L.L.
66080	1/4"	3/8"	3/8"	1-15/16"	3,600 lb	14,400 lb
66081	5/16"	3/8"	7/16"	2-1/4"	5,400 lb	21,000 lb
66082	3/8"	1/2"	1/2"	2-5/8"	7,500 lb	30,000 lb
66083	1/2"	13/16"	11/16"	3-3/16"	12,750 lb	51,000 lb

Swivel Eye Hook

Forged carbon steel. Clear zinc plated finish.
Not recommended for overhead lifting.

PART#	A	B	C	W.L.L.	U.L.L.
66134	1-1/4"	7/8"	5-9/16"	1,500 lb	7,500 lb

SAFETY HOOKS

Forged carbon steel. Clear zinc plated finish.
Not recommended for overhead lifting.

Safety Slip Hooks

PART#	CHAIN DIAMETER	A	B	C	W.L.L.	U.L.L.
66133	1/4"	1/2"	3/4"	3-5/8"	1,950 lb	7,800 lb
66135	5/16"	5/8"	13/16"	4-3/16"	2,875 lb	11,500 lb

Safety Winch Hook

PART#	CHAIN DIAMETER	A	B	C	W.L.L.	U.L.L.
66136	1/4"	3/4"	3/4"	3-5/8"	1,500 lb	7,500 lb

HOIST HOOKS

Complete with latches. Enamel painted finish. 5:1 safety factor.

Eye Hoist Hooks - Carbon Steel (Orange)

PART#	A	B	C	W.L.L. (TONS)	U.L.L. (TONS)	LATCH KIT
66145	3/4"	13/16"	4-5/16"	3/4	3-3/4	66151
66146	7/8"	1-1/32"	4-7/8"	1	5	66152
66147	1-1/8"	1-1/16"	5-5/8"	1-1/2	7-1/2	66153
66148	1-1/4"	1-7/32"	6-1/2"	2	10	66154
66149	1-1/2"	1-1/2"	8"	2-1/2	15	66155
66150	2"	1-7/8"	10-1/4"	5	25	66156

Not recommended for overhead lifting

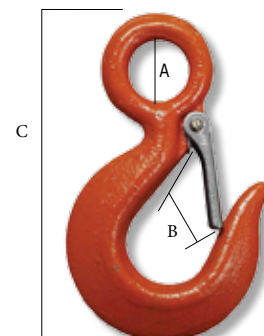
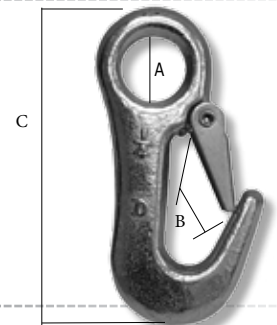
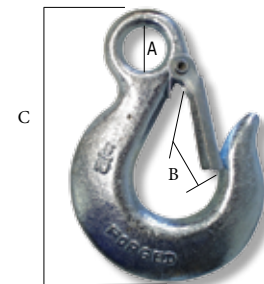
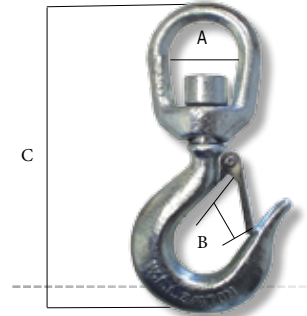
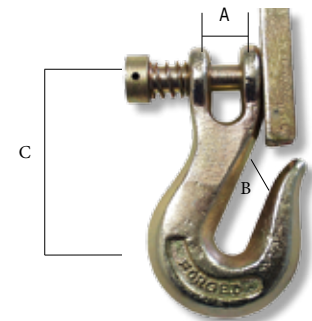

Not recommended for overhead lifting

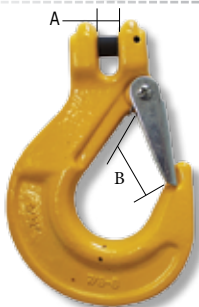
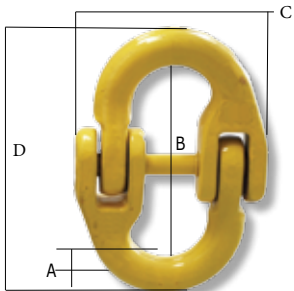
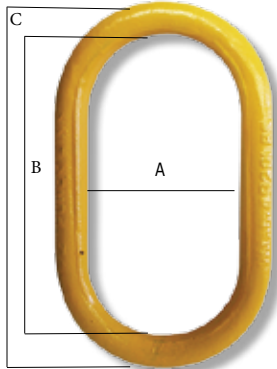
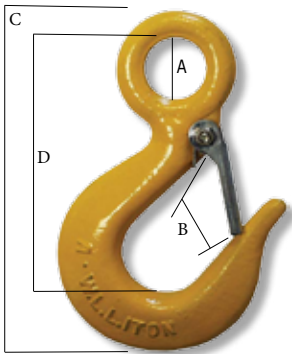

Eye Hoist Hooks - Alloy Steel (Yellow)

Complete with latches. Enamel painted finish. 5:1 safety factor.

PART#	A	B	C	D	W.L.L. (TONS)	LATCH KIT
67145	5/8"	15/16"	3-7/8"	2-3/4"	3/4	66151
67146	3/4"	1-1/32"	4-3/8"	3-3/16"	1	66152
67147	15/16"	1-1/8"	4-7/8"	3-11/16"	1-1/2	66153
67148	1-1/8"	1-7/32"	5-1/2"	4"	2	66154
67149	1-1/4"	1-3/8"	6-1/2"	4-11/16"	3	66155

GRADE 80 FITTINGS

NEVER exceed Working Load Limits! Do not use less than Grade 80 fittings with any application! Do not use chain or fittings showing signs of wear or deformities!

Master Links

PART#	CHAIN DIAMETER	A	B	C	W.L.L.
67005	1/2"	2-1/2"	5"	6"	7,000 lb
67006	5/8"	3"	6"	7-1/4"	9,000 lb
67007	3/4"	2-3/4"		7"	10,500 lb
67008	1"	3-1/2"	7"	9"	24,350 lb

Connecting Links

PART#	CHAIN DIAMETER	A	B	C	D	W.L.L.
67020	1/4"	3/8"	1-7/8"	1-3/4"	2-1/2"	7,000 lb
67021	5/16"	25/64"	2-1/8"	2"	3"	9,000 lb
67022	3/8"	17/32"	2-1/2"	2-1/2"	3-1/2"	10,500 lb
67023	1/2"	5/8"	3-7/16"	3-7/32"	4-1/2"	24,360 lb

Clevis Grab Hooks

PART#	CHAIN DIAMETER	A	B	C	W.L.L.
67025	1/4"	3/8"	3/8"	3-11/16"	3,500 lb
67026	3/8"	1/2"	1/2"	5"	7,100 lb
67027	1/2"	5/8"	5/8"	5-13/16"	12,000 lb

Clevis Sling Hooks

PART#	CHAIN DIAMETER	A	B	C	W.L.L.	LATCH KIT
67030	1/4"	3/8"	1-3/8"	5-5/16"	4,500 lb	67030-1
67031	3/8"	9/16"	1-11/16"	6-5/16"	6,940 lb	67031-1
67032	1/2"	5/8"	2"	7-5/8"	11,685 lb	67032-1

Self-Locking Clevis Hooks

PART#	CHAIN DIAMETER	A	B	W.L.L.	LATCH KIT
67040	9/32"	3-1/2"	6-1/4"	4,500 lb	67040-1
67041	3/8"	4-3/8"	7-1/2"	6,400 lb	67041-1
67042	1/2"	5-7/16"	9-1/2"	10,800 lb	67042-1

Swivel Eye Hoist Hooks

Design factor 4:1.

PART#	CHAIN DIAMETER	A	B	W.L.L.	LATCH KIT
67050	1/4"	2-3/4"	7"	4,500 lb	67040-1
67051	3/8"	4-3/8"	10-3/4"	7,100 lb	67041-1
67052	1/2"	5-3/8"	12-3/4"	12,000 lb	67042-1

Not recommended for overhead lifting

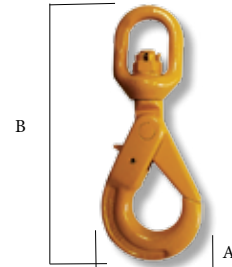
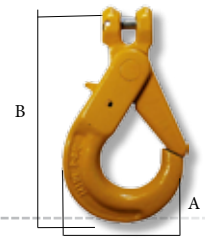

SHACKLES

Screw Pin Anchor Shackles

Heat treated alloy forged steel. Oversized alloy pin. Hot dipped galvanized finish.

Meets Fed. Spec. RR-C-271D, Type 4A, Class 2, Design factor 6:1.

Marked for Traceability: "D" marking for Dynaliner.

PART#	BODY DIAMETER	PIN DIAMETER	A	B	C	W.L.L. (TONS)
66000	1/4"	5/16"	1-1/8"	3/4"	1/2"	1/2
66001	5/16"	3/8"	1-1/4"	7/8"	1/2"	3/4
66002	3/8"	7/16"	1-7/16"	1"	5/8"	1
66003	7/16"	1/2"	1-11/16"	1-1/8"	3/4"	1-1/2
66004	1/2"	5/8"	1-7/8"	1-5/16"	3/4"	2
66005	5/8"	3/4"	2-3/8"	1-5/8"	1-1/16"	3-1/4
66006	3/4"	7/8"	2-3/4"	2"	1-1/4"	4-3/4
66007	7/8"	1"	3-5/16"	2-1/4"	1-7/16"	6-1/2
66008	1"	1-1/8"	3-3/4"	2-11/16"	1-11/16"	8-1/2
66059	1-1/8"	1-1/4"	4-1/4"	2-5/8"	1-3/4"	9-1/2
66060	1-1/4"	1-3/8"	4-11/16"	3"	2"	12
66061	1-3/8"	1-1/2"	5-1/4"	3-5/8"	2-1/4"	13-1/2
66062	1-1/2"	1-5/8"	5-3/4"	3-7/8"	2-3/8"	17

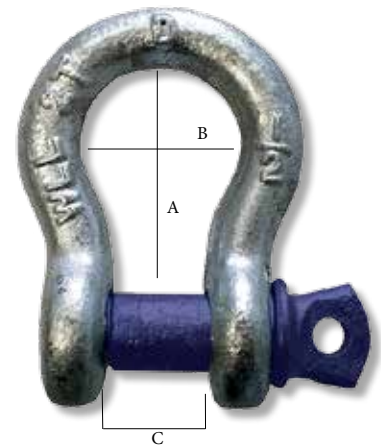

Commercial Grade Anchor Shackles

Oversized pin. C1010 Carbon Steel, galvanized. For general applications. Design factor 2:1. Not to be used for lifting.

PART#	BODY DIAMETER	PIN DIAMETER	A	B	C	W.L.L.
66010	1/4"	5/16"	1-1/8"	3/4"	1/2"	600 lb
66011	5/16"	3/8"	1-7/32"	13/16"	17/32"	1/2 Ton
66012	3/8"	7/16"	1-7/16"	15/16"	1-7/16"	3/4 Tons
66013	1/2"	5/8"	1-7/8"	1-5/16"	13/16"	1-1/2 Tons
66014	5/8"	3/4"	2-3/8"	1-11/16"	1-1/16"	2-1/4 Tons
66017	7/16"	1/2"	1-11/16"	1-5/32"	11/16"	1-1/4 Tons

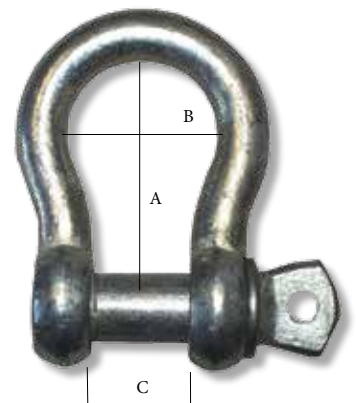

Not recommended for overhead lifting

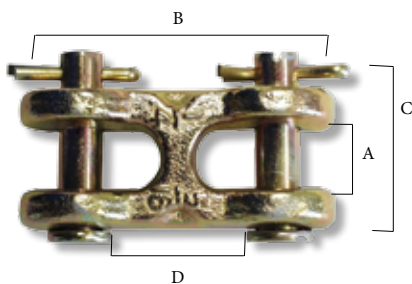
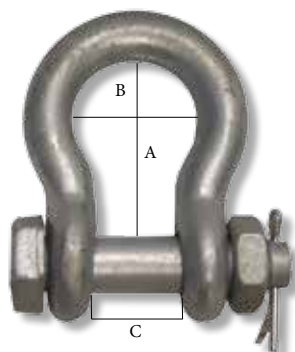
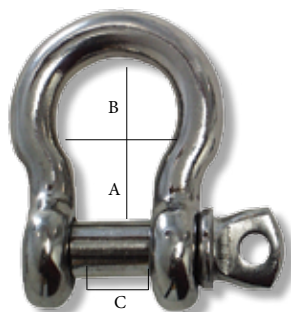

Stainless Steel Shackles

A151 316 Stainless steel.

PART#	BODY DIAMETER	PIN DIAMETER	A	B	C	W.L.L.
64060	3/16"	1/4"	7/8"	11/16"	3/8"	300 lb
64061	1/4"	5/16"	1-1/8"	3/4"	1/2"	450 lb
64062	5/16"	13/32"	1-3/16"	13/16"	19/32"	650 lb
64063	3/8"	1/2"	1-3/8"	1"	11/16"	1,000 lb

Screw Pin Chain Shackles

High-tensile forged steel. Oversized pin. Hot dipped galvanized finish.

Meets Fed. Spec. RR-C-271D, Type 4B, Class 2. Design factor 6:1.

PART#	BODY DIAMETER	PIN DIAMETER	A	B	W.L.L. (TONS)
66020	1/4"	5/16"	7/8"	7/16"	1/2
66021	5/16"	3/8"	1"	9/16"	3/4
66022	3/8"	7/16"	1-1/4"	5/8"	1
66023	7/16"	1/2"	1-7/16"	11/16"	1-1/2
66024	1/2"	5/8"	1-5/8"	3/4"	2

Bolt Type Anchor Shackles

High-tensile forged steel. Oversized pin. Hot dipped galvanized finish.

Meets Fed. Spec. RR-C-271D, Type 4A, Class 3. Design factor 6:1.

PART#	BODY DIAMETER	PIN DIAMETER	A	B	C	W.L.L. (TONS)
66900	1/4"	5/16"	1-1/8"	3/4"	1/2"	1/2
66901	5/16"	3/8"	1-1/4"	7/8"	1/2"	3/4
66902	3/8"	7/16"	1-7/16"	1"	5/8"	1
66903	7/16"	1/2"	1-11/16"	1-1/8"	3/4"	1-1/2
66904	1/2"	5/8"	1-7/8"	1-5/16"	3/4"	2
66905	5/8"	3/4"	2-3/8"	1-5/8"	1-1/16"	3-1/4
66906	3/4"	7/8"	2-3/4"	2"	1-1/4"	4-3/4
66907	7/8"	1"	3-5/16"	2-1/4"	1-7/16"	6-1/2
66908	1"	1-1/8"	3-3/4"	2-11/16"	1-11/16"	8-1/2
66959	1-1/8"	1-1/4"	4-1/4"	2-5/8"	1-3/4"	9-1/2
66960	1-1/4"	1-3/8"	4-11/16"	3"	2"	12

Mid Links

Forged carbon steel body. Alloy steel pins. Yellow zinc dichromate plated finish. For use with Grade 30, 40 & 70 chain.

PART#	CHAIN	PIN DIAMETER	A	B	C	D	W.L.L.	U.L.L.
66138	1/4"-5/16"	3/8"	7/16"	2-1/2"	1-5/8"	1-3/16"	4,700 lb	18,800 lb
66139	3/8"	7/16"	1/2"	2-13/16"	1-13/16"	1-3/8"	6,600 lb	26,400 lb
66140	7/16"-1/2"	9/16"	5/8"	3-5/8"	2-3/16"	1-3/4"	11,250 lb	45,000 lb

Notice: If pins are difficult to remove after 1/4 turn, it has likely been overloaded, and must be discarded and replaced.

LINKS

Cold Shuts

Formed steel. Clear zinc plated finish.

PART#	WIRE	W.L.L.	PACKAGE QUANTITY
66440	3/16"	550 lb	10
66441	1/4"	750 lb	10
66442	5/16"	1,250 lb	5
66443	3/8"	1,900 lb	5
66444	7/16"	2,650 lb	5
66445	1/2"	3,500 lb	5

Double Swivel

Ductile cast iron. Hot dipped, galvanized finish.

PART#	CHAIN	A	B	W.L.L.	U.L.L.
66163	3/8"	5/8"	5-7/16"	2,250 lb	5,625 lb



Forged Chain Swivel

Hot dipped, galvanized. Meets Fed. Spec. RR-C-271D-Type 7, Class 2. Not designed to swivel under load!

PART#	A	B	C	D	W.L.L.	U.L.L.
66165	1/4"	1-1/16"	3"	3-7/16"	850 lb	4,250 lb
66166	5/16"	1-1/4"	3-9/16"	4-1/8"	1,250 lb	6,250 lb
66167	3/8"	1-1/2"	4-5/16"	5-7/16"	2,250 lb	11,250 lb
66168	1/2"	2"	5-7/16"	6-7/16"	3,600 lb	18,000 lb

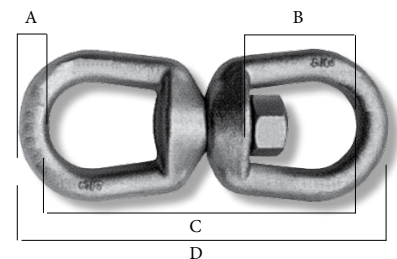

Repair Links

Mild steel. Clear zinc plated finish.

PART#	CHAIN	A	B	W.L.L.	U.L.L.	PACKAGE QUANTITY
66400	1/8"	3/4"	1/4"	150 lb	600 lb	10
66401	3/16"	1"	1/2"	200 lb	800 lb	10
66402	1/4"	1-1/4"	1/2"	400 lb	1,600 lb	10
66403	5/16"	1-1/2"	3/4"	700 lb	2,800 lb	5
66404	3/8"	1-5/8"	3/4"	1,500 lb	6,000 lb	5

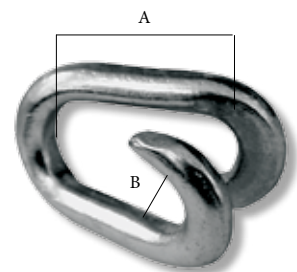

Link Locks

PART#	CHAIN	A	B	W.L.L.	U.L.L.	PACKAGE QUANTITY
66413	1/4"	2-1/4"	5/8"	1,000 lb	3,700 lb	5
66414	5/16"	2-3/4"	3/4"	1,500 lb	6,000 lb	5
66415	3/8"	3-1/8"	3/4"	3,000 lb	12,000 lb	5

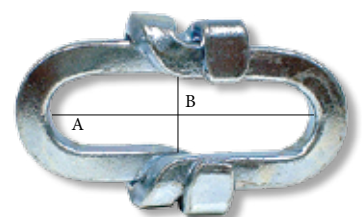

Not recommended for overhead lifting

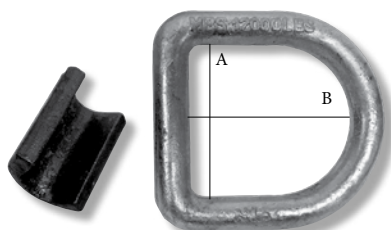
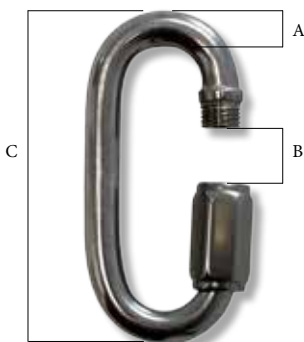
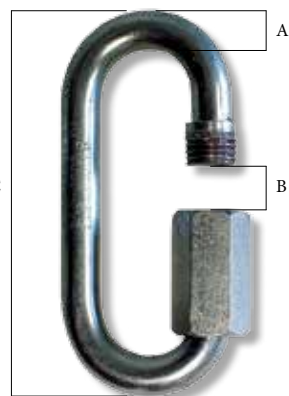
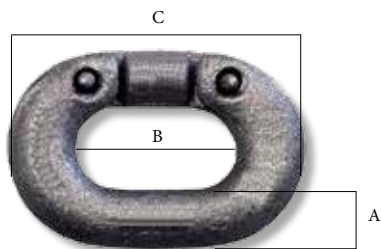

"Missing Link" Connecting Links

Forged steel, Grade 30.

PART#	CHAIN	A	B	C	W.L.L.	PACKAGE QUANTITY
66416	1/4"	9/32"	7/8"	1-1/2"	1,125 lb	5
66417	5/16"	11/32"	15/16"	1-11/16"	1,700 lb	5
66418	3/8"	13/32"	1-1/8"	2-1/16"	2,325 lb	5

Quick Links - Zinc Plated

Zinc plated. Mild steel.

PART#	A	B	C	W.L.L.	U.L.L.	PACKAGE QUANTITY
66430	1/8"	3/16"	1-7/16"	220 lb	550 lb	10
66431	3/16"	1/4"	2"	660 lb	1,650 lb	10
66432	1/4"	9/32"	2-1/4"	880 lb	2,200 lb	10
66433	5/16"	11/32"	2-15/16"	1,760 lb	4,400 lb	5
66434	3/8"	7/16"	3-9/16"	2,200 lb	5,500 lb	5
66435	7/16"	1/2"	3-11/16"	2,640 lb	6,600 lb	5
66436	1/2"	9/16"	4-1/8"	3,300 lb	8,250 lb	5

Quick Links - Stainless Steel

A151 316 Stainless Steel.

PART#	A	B	C	W.L.L.	PACKAGE QUANTITY
64000	1/8"	3/16"	1-7/16"	220 lb	5
64001	5/32"	7/32"	1-5/8"	400 lb	5
64002	1/4"	11/32"	2-9/32"	880 lb	5
64003	5/16"	3/8"	2-7/8"	1,600 lb	5
64004	3/8"	1/2"	3-1/2"	2,200 lb	5

D-RINGS

Forged-D-Ring With Weld-On Bracket

Forged, hot dipped, galvanized. Comes with weld-on bracket.

PART#	WIRE DIAMETER	A	B	W.L.L.
66185	1/2"	2-1/4"	2-1/2"	12,000 lb
66186	5/8"	3"	3"	18,000 lb
66187	3/4"	3"	3"	26,500 lb
66188	1"	3"	4"	47,000 lb

SMALL DIAMETER CABLE (AIRCRAFT CABLE)

Galvanized steel. Supplied on spools.

7X7 Construction

PART#	CABLE DIAMETER	BREAK STRENGTH	SPOOL LENGTH
77000	1/16"	480 lb	500'
77001	3/32"	920 lb	500'
77002	1/8"	1,700 lb	250'
77010	1/16"	480 lb	1,000'
77011	3/32"	920 lb	1,000'
77012	1/8"	1,700 lb	1,000'

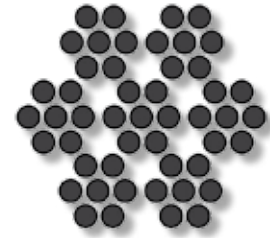

7X19 Construction

PART#	CABLE DIAMETER	BREAK STRENGTH	SPOOL LENGTH
77003	5/32"	2,800 lb	250'
77004	3/16"	4,200 lb	250'
77005	1/4"	7,000 lb	250'
77006	5/16"	9,800 lb	250'
77007	3/8"	14,400 lb	250'
77013	5/32"	2,800 lb	1,000'
77014	3/16"	4,200 lb	1,000'
77015	1/4"	7,000 lb	1,000'
77016	5/16"	9,800 lb	1,000'
77017	3/8"	14,400 lb	1,000'

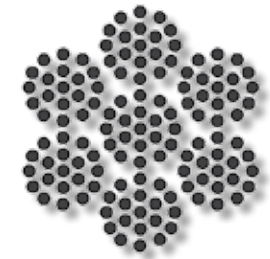

Wire Rope

Supplied in coils. Oily finish. Fibre core.

PART#	ROPE DIAMETER	BREAK STRENGTH	SPOOL LENGTH
77020	1/2"	22,000 lb	100'

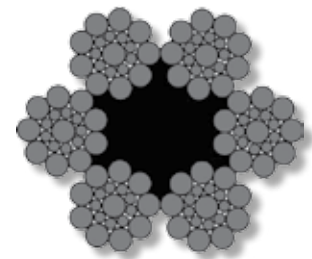

NOTE: Properly swagged cable sleeves are capable of maintaining over 90% of the breaking strength of the cable.

The maximum holding strength of cable stops are approximately 1/3 of the strength of the cable.

To determine the exact holding strength, a pull test must be performed prior to use.

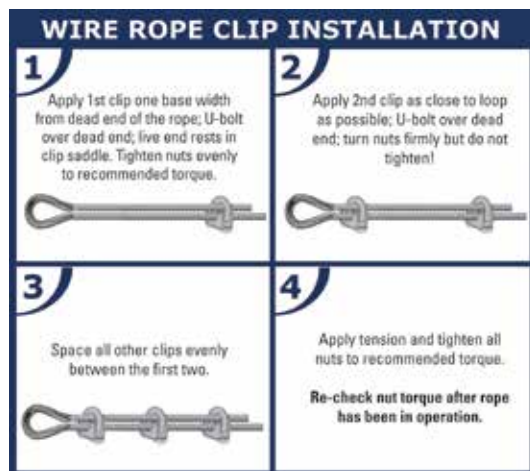

WIRE ROPE CLIPS

Complete with U-bolts and nuts.

Malleable Iron Wire Rope Clips

Galvanized iron saddles. Meets Fed. Spec. FF-C-450, Type 1, Class 2*, (except 1/8").

PART#	CABLE	PACKAGE QUANTITY
77030	1/8"	10
77031	3/16"	10
77032	1/4"	10
77033	5/16"	10
77034	3/8"	5
77035	1/2"	5
77036	5/8"	1
77037	3/4"	1
77038	7/8"	1
77039	1"	1

Forged Steel Wire Rope Clips

Forged steel body. Zinc plated finish. Meets Fed. Spec. FF-C-450, Type 1, Class 1**.

PART#	CABLE	PACKAGE QUANTITY
77040	1/8"	5
77041	3/16"	5
77042	1/4"	5
77043	5/16"	5
77044	3/8"	5
77045	1/2"	5
77046	5/8"	1
77047	3/4"	1
77048	7/8"	1
77049	1"	1

Stainless Steel Wire Rope Clips

Metric thread. Stainless Steel Grade 304***.

PART#	CABLE	PACKAGE QUANTITY
64020	1/8"	5
64021	3/16"	5
64022	1/4"	5
64023	5/16"	5
64024	3/8"	5

* **Type 1** - Single grip, single saddle, with U-bolts and nuts (MS16842).

Class 2 - Assembled with separate hex headed bolts and nuts (MS51868).

** **Type 1** - Single grip, single saddle, with U-bolts and nuts (MS16842).

Class 1 - Steel saddle.

*** **Grade 304** - is the standard "18/8" stainless; it is the most versatile and most widely used stainless steel, available in a wider range of products, forms and finishes than any other. It has excellent forming and welding characteristics.



THIMBLES

Cable Thimbles

Stainless Steel.

PART#	CABLE	PACKAGE QUANTITY
64040	1/8"	5
64041	3/16"	5
64042	1/4"	5
64043	5/16"	5
64044	3/8"	5

Standard Wire Rope Thimbles

Zinc plated steel. Meets Fed. Spec. FF-T-276B, Type 2.

PART#	CABLE	PACKAGE QUANTITY	PART#	CABLE	PACKAGE QUANTITY
77050	1/8"	10	77054	3/8"	10
77051	3/16"	10	77055	1/2"	5
77052	1/4"	10	77056	5/8"	1
77053	5/16"	10			

Warning: Thimbles are not designed to support loads.

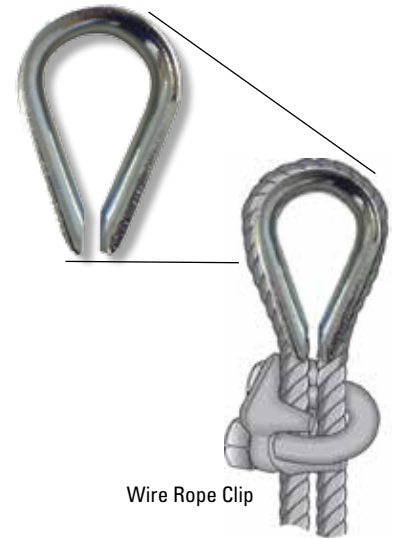

Wire Rope Clip

Heavy Wire Rope Thimbles

Hot dipped galvanized steel. Meets Fed. Spec. FF-T-276B, Type 3.

PART#	CABLE	PACKAGE QUANTITY	PART#	CABLE	PACKAGE QUANTITY
77060	1/4"	10	77065	3/4"	1
77061	5/16"	10	77066	7/8"	1
77062	3/8"	10	77067	1"	1
77063	1/2"	5	77068	1-1/8"	1
77064	5/8"	1			



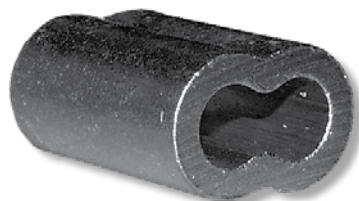

CABLE STOPS AND SLEEVES

Cable Stops

Aluminum.

PART#	CABLE	LENGTH	PACKAGE QUANTITY	DYNAPAK	PACKAGE QUANTITY
77070	1/16"	3/16"	10	97070	10 x 77070
77071	3/32"	5/16"	10	97071	10 x 77071
77072	1/8"	5/16"	10	97072	10 x 77072
77073	5/32"	5/16"	10	97073	10 x 77073
77074	3/16"	3/8"	10	97074	10 x 77074
77075	1/4"	11/16"	5	97075	5 x 77075

Cable Sleeves

Aluminum.

PART#	CABLE	LENGTH	PACKAGE QUANTITY	DYNAPAK	PACKAGE QUANTITY
77080	1/16"	3/8"	10	97080	10 x 77080
77081	3/32"	1/2"	10	97081	10 x 77081
77082	1/8"	5/8"	10	97082	10 x 77082
77083	5/32"	9/16"	10	97083	10 x 77083
77084	3/16"	1"	10	97084	6 x 77084
77085	1/4"	1-1/8"	10	97085	5 x 77085
77086	5/16"	1-1/4"	10		
77087	3/8"	1-1/2"	10		

NOTE:

Properly swagged cable sleeves are capable of maintaining over 90% of the breaking strength of the cable.

The maximum holding strength of cable stops are approximately 1/3 of the strength of the cable.

To determine the exact holding strength, a pull test must be performed prior to use.

CABLE CUTTERS AND SWAGERS

Cable Cutters

Aluminum drop-forged handles. Heat-treated blades (HRC 56-63). SK-5 cutter material.

PART#	REFERENCE#	CUTTING CAPACITY	OVERALL LENGTH
77107	C-7	Up to 5/32" Diameter Cable	7-1/2"
77116	C-16	Up to 5/8" Diameter Cable	23"



77107



77116

Bench Swager

For in-shop, one location jobs. Multi-compression jaws swager for 1/16", 3/32", 1/8", 5/32" & 3/16" oval/stop sleeves.

PART#	LENGTH	HEIGHT (OPEN)	WEIGHT
77101	22-1/2"	24"	3 kg



Hand Swager

For installing aluminum or copper sleeves & stops. Heat-treated alloy jaws.

PART#	CRIMPING CAPACITY	LENGTH
77100	1/16" to 3/16" Diameter	24"



TIRE CHAIN PLIERS AND HARDWARE

Tire Chain Pliers

Opens & closes chain hardware easily. Alloy steel jaws. Steel handles with rubber hand grips.

PART#	OVERALL LENGTH	JAW OPENING
68100	32"	2"



Tire Chain Hardware

Made from C-1020 carbon steel.

PART#	DESCRIPTION	OVERALL LENGTH
68010	Boomer	7"
68011	Clevis & Thumbscrew	2"
68012	C-Hook	4"
68013	Boomer	6-1/2"
68014	C-Link	2-1/2"
68015	C-Hook	3-1/2"





PULLEYS

Die Cast Aluminium Pulleys

Single groove for 3L, 4L or "A" belts.
Supplied with 5/16" x 1/2" UNC set screws.

Solid

PART#	OUTSIDE DIAMETER	BORE	KEYWAY	PART#	OUTSIDE DIAMETER	BORE	KEYWAY
55400	1-1/2"	1/2"	No	55413	3"	3/4"	Yes
55401	1-1/2"	5/8"	No	55414	3-1/2"	1/2"	No
55402	2"	1/2"	No	55415	3-1/2"	5/8"	Yes
55403	2"	5/8"	Yes	55416	3-1/2"	3/4"	Yes
55404	2"	3/4"	Yes	55417	4"	1/2"	No
55405	2-1/4"	1/2"	No	55418	4"	5/8"	Yes
55406	2-1/4"	5/8"	Yes	55419	4"	3/4"	Yes
55407	2-1/4"	3/4"	Yes	55420	4-1/2"	1/2"	No
55408	2-1/2"	1/2"	No	55421	4-1/2"	5/8"	Yes
55409	2-1/2"	5/8"	Yes	55422	4-1/2"	3/4"	Yes
55410	2-1/2"	3/4"	Yes	55423	5"	1/2"	No
55411	3"	1/2"	No	55424	5"	5/8"	Yes
55412	3"	5/8"	Yes	55425	5"	3/4"	Yes

Spoked

PART#	OUTSIDE DIAMETER	BORE	KEYWAY	PART#	OUTSIDE DIAMETER	BORE	KEYWAY
55426	6"	1/2"	No	55430	7"	5/8"	Yes
55427	6"	5/8"	Yes	55431	7"	3/4"	Yes
55428	6"	3/4"	Yes	55433	8"	5/8"	Yes
55429	7"	1/2"	No	55434	8"	3/4"	Yes

Variable Speed

Solid type. For "A" & "B" belts. Opening the pulley increases the speed at which it rotates. Supplied with set screws.

PART#	OUTSIDE DIAMETER	BORE	KEYWAY
55490	3-1/4"	1/2"	No
55491	3-1/4"	5/8"	Yes
55492	3-1/4"	3/4"	Yes

DIE CAST AWNING PULLEYS

Single Fixed

PART#	PULLEY DIAMETER	ROPE DIAMETER	EYE DIAMETER	W.L.L.
55900	3/4"	up to 3/16"	3/16"	65 lb
55901	1"	up to 1/4"	1/4"	110 lb
55902	1-1/4"	up to 3/8"	3/8"	165 lb
55903	1-1/2"	up to 3/8"	3/8"	220 lb
55904	2"	up to 1/2"	1/2"	330 lb

Double Fixed

PART#	PULLEY DIAMETER	ROPE DIAMETER	EYE DIAMETER	W.L.L.
55906	3/4"	up to 3/16"	3/16"	65 lb
55907	1"	up to 1/4"	3/16"	110 lb
55908	1-1/2"	up to 3/8"	3/8"	220 lb
55909	2"	up to 1/2"	1/2"	330 lb

Single Swivel

PART#	PULLEY DIAMETER	ROPE DIAMETER	EYE DIAMETER	W.L.L.
55915	3/4"	up to 3/16"	1/2"	65 lb
55916	1"	up to 1/4"	7/16"	110 lb
55917	1-1/4"	up to 3/8"	13/16"	165 lb
55918	1-1/2"	up to 3/8"	13/16"	220 lb
55919	2"	up to 1/2"	13/16"	330 lb

Double Swivel

PART#	PULLEY DIAMETER	ROPE DIAMETER	EYE DIAMETER	W.L.L.
55925	3/4"	up to 3/16"	7/16"	65 lb
55926	1"	up to 1/4"	7/16"	110 lb
55927	1-1/4"	up to 3/8"	13/16"	165 lb
55928	1-1/2"	up to 3/8"	13/16"	220 lb

STEEL PULLEY BLOCKS

Swivel

PART#	SHEAVE DIAMETER	LENGTH	ROPE DIAMETER	EYE DIAMETER	W.L.L.
55800	1-1/2"	3-1/2"	up to 3/8"	3/8"	460 lb
55801	2"	4"	up to 3/8"	3/8"	480 lb
55802	2-1/2"	4-1/2"	up to 3/8"	3/8"	550 lb
55803	3"	4-3/4"	up to 1/2"	3/8"	650 lb

Fixed

PART#	SHEAVE DIAMETER	LENGTH	ROPE DIAMETER	EYE DIAMETER	W.L.L.
55810	1-1/2"	3-1/4"	up to 3/8"	1/2"	420 lb
55811	2"	3-3/4"	up to 3/8"	1/2"	480 lb
55812	2-1/2"	4-1/4"	up to 3/8"	1/2"	550 lb
55813	3"	4-3/4"	up to 3/8"	3/4"	650 lb

Swivel With Double Hooks

PART#	SHEAVE DIAMETER	LENGTH	ROPE DIAMETER	W.L.L.
55830	1-1/2"	5"	up to 3/8"	460 lb



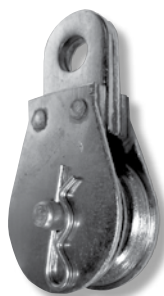

STEEL PULLEY BLOCKS (DEUER TYPE)

Swivel Eye

PART#	DIAMETER	LENGTH	MAXIMUM CABLE DIAMETER	EYE DIAMETER	W.L.L.
55850	1-1/2"	3-1/2"	3/16"	3/8"	460 lb
55851	2"	4-1/2"	3/16"	3/8"	480 lb
55852	2-1/2"	5"	1/4"	3/8"	550 lb
55853	3"	4-3/4"	1/4"	3/8"	650 lb

Fixed Eye

PART#	DIAMETER	LENGTH	MAXIMUM CABLE DIAMETER	EYE DIAMETER	W.L.L.
55860	1-1/2"	3-1/4"	3/16"	1/2"	420 lb
55861	2"	3-3/4"	3/16"	1/2"	480 lb
55862	2-1/2"	4-1/4"	1/4"	1/2"	550 lb
55863	3"	4-3/4"	1/4"	3/4"	650 lb

Double Hook With Swivel Eye

PART#	DIAMETER	LENGTH	MAXIMUM CABLE DIAMETER	W.L.L.
55870	1-1/2"	5"	3/16"	460 lb
55871	2"	5-1/2"	3/16"	480 lb
55872	2-1/2"	6"	1/4"	550 lb
55873	3"	7-1/2"	1/4"	650 lb

Single Hook

PART#	DIAMETER	LENGTH	MAXIMUM CABLE DIAMETER	W.L.L.
55880	1-1/2"	5"	3/16"	460 lb
55881	2"	5-1/2"	3/16"	480 lb
55882	2-1/2"	6"	1/4"	550 lb
55883	3"	7-1/2"	1/4"	650 lb

Replacement Sheaves

PART#	DIAMETER	BORE SIZE	W.L.L.
55840	1-1/2"	5/16"	420 lb
55841	2"	5/16"	480 lb
55842	2-1/2"	5/16"	550 lb
55843	3"	7/16"	650 lb

Replacement Sheaves

For heavy duty pulley blocks.

PART#	SHEAVE DIAMETER	W.L.L.
55890	1-1/2"	460 lb
55891	2"	480 lb
55892	2-1/2"	550 lb
55893	3"	650 lb



STAKE RACK HARDWARE

Ductile iron. Clear zinc plated finish. Rockwell hardness: 5.4 – 18 (HRC).

Stake Hooks

PART#	DESCRIPTION	PIN LENGTH	PIN DIAMETER
23050	Left-Hand	3"	9/16"
23051	Right-Hand	3"	9/16"
23052	Left-Hand	6"	9/16"
23053	Right-Hand	6"	9/16"



Stake Eye

PART#	EYE INSIDE DIAMETER
23054	5/8"



HOOKS

Gate Hooks

Clear zinc plated finish.

PART#	D (LENGTH)	WIRE DIAMETER	PACKAGE QUANTITY
65051	2"	0.155"	10
65052	2-1/2"	0.155"	10
65053	3"	0.176"	10

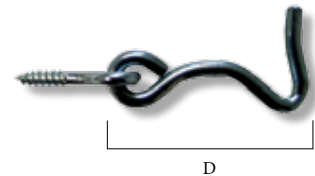

S-Hooks

Clear zinc plated finish.

PART#	WIRE DIAMETER	OVERALL LENGTH	PACKAGE QUANTITY
66230	0.093" (3/32")	1"	10
66232	0.105" (7/64")	1-3/32"	10
66234	0.120" (1/8")	1-3/8"	10
66235	0.162" (5/32")	1-1/2"	10
66236	0.141" (9/64")	2-1/8"	10
66238	0.250" (1/4")	2-5/8"	10
66239	0.188" (3/16")	3"	10





Tarp Hooks

Zinc plated formed steel.

PART#	WIRE DIAMETER	OVERALL LENGTH	PACKAGE QUANTITY
66423	3/8"	3-1/2"	10
66424	1/4"	2-1/2"	10

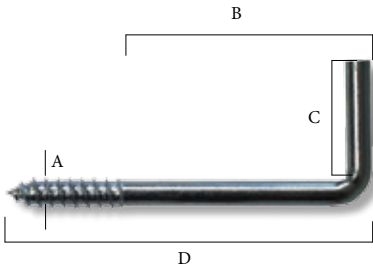

Cornice Hooks

Clear zinc plated finish.

PART#	A	B	C	D	PACKAGE QUANTITY
65040	9/32"	1-3/4"	1"	3-1/16"	10
65041	3/16"	1-5/8"	7/8"	2-5/8"	10
65042	5/32"	1-3/8"	13/16"	2-1/4"	10
65043	1/8"	1-1/8"	11/16"	1-13/16"	10
65044	3/32"	3/4"	1/2"	1-3/8"	10

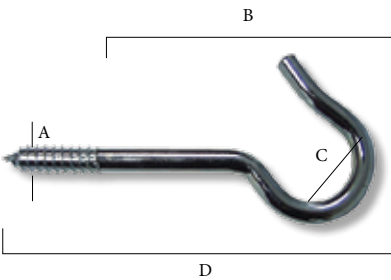

Screw Hooks

Clear zinc plated finish.

PART#	A	A (DECIMAL)	B	C	C (MM)	D	PACKAGE QUANTITY
65070	1/4"	0.25"	3-1/16"	1-1/32"	1.03	4-5/16"	10
65071	7/32"	0.21"	3-3/16"	1"	25.4	4-7/16"	10
65072	3/16"	0.19"	2-5/8"	27/32"	84.38	3-7/8"	10
65073	5/32"	0.158"	2-1/8"	11/16"	17.44	3-3/8"	10
65074	3/16"	0.138"	2-9/16"	1/2"	13.2	2-9/16"	10
65075	7/64"	0.112"	2-1/16"	13/32"	0.41	2-1/16"	10
65076	3/32"	0.086"	1-1/16"	9/32"	0.28	1-11/16"	10
65077	5/64"	0.073"	3/4"	15/16"	0.94	1-5/16"	10

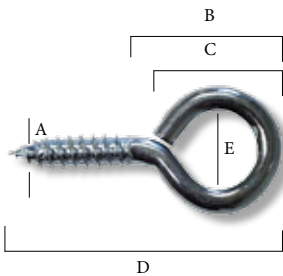

Screw Eyes

Clear zinc plated finish.

PART#	A	B	C	D	E	PACKAGE QUANTITY
65006	0.216"	15/16"	1"	1-15/16"	17/32"	10
65014	0.112"	1/2"	3/8"	1-1/16"	11/32"	10
65017	0.190"	13/16"	5/8"	1-9/16"	25/64"	10
65018	0.158"	11/16"	5/8"	1-5/16"	21/64"	10
65020	0.112"	1/2"	13/32"	15/16"	1/4"	10
65024	0.250"	1-1/8"	7/8"	1-5/16"	19/64"	10

Lagscrew Eyebolts

Clear zinc plated finish.

PART#	A	B	C	D	E	PACKAGE QUANTITY
65161	1/4"	1-5/16"	2-3/4"	3-3/4"	1/2"	10
65162	1/4"	1-7/8"	4"	5"	1/2"	10
65163	5/16"	1-7/8"	2-3/4"	4"	5/8"	10
65164	5/16"	1-7/8"	4-3/4"	6"	5/8"	10
65165	3/8"	1-15/16"	3"	4-1/2"	3/4"	10
65166	3/8"	2-7/8"	6-1/2"	8"	3/4"	10

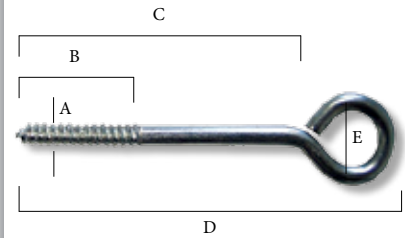

Shoulder Eyebolts

Forged steel. Galvanized finish. Supplied with nut. Sold individually.

PART#	A	B	C	D	E	W.L.L.
66100	1/4"	1-1/2"	2"	3"	1/2"	500 lb
66101	5/16"	1-1/2"	2-1/4"	3-1/2"	5/8"	800 lb
66102	3/8"	1-1/2"	2-1/2"	4"	3/4"	1,200 lb
66103	1/2"	1-1/2"	3-1/4"	5-1/4"	1"	2,200 lb
66104	5/8"	1-3/4"	4"	6-1/2"	1-1/4"	3,500 lb
66105	1/4"	2-1/2"	4"	5"	1/2"	500 lb
66106	5/16"	2-1/2"	4-1/4"	5-1/2"	5/8"	800 lb
66107	3/8"	2-1/2"	6"	7-1/2"	3/4"	1,200 lb
66108	1/2"	3"	6"	7-3/4"	1"	2,200 lb

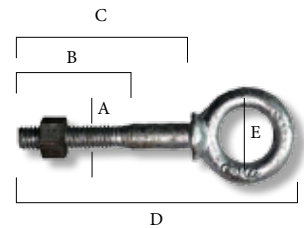

Eyebolts

Wire Formed. Supplied with Nut. Zinc plated finish.

PART#	A	B	C	D	E	PACKAGE QUANTITY
65102	3/16"	1"	1-3/8"	2"	3/8"	10
65104	3/16"	1-5/8"	1-3/4"	2-1/2"	3/8"	10
65106	1/4"	1"	1"	2"	9/16"	10
65107	1/4"	1-3/8"	1-1/2"	2-1/2"	9/16"	10
65108	1/4"	1-3/4"	2"	3"	9/16"	10
65109	1/4"	2-3/4"	3"	4"	9/16"	10
65110	1/4"	3"	4"	5"	9/16"	10
65111	1/4"	3"	5"	6"	9/16"	10
65112	5/16"	1-3/4"	2"	3-1/4"	3/4"	10
65113	5/16"	2-3/16"	2-1/2"	4"	3/4"	10
65114	5/16"	3"	3-1/2"	5"	3/4"	10
65115	5/16"	3"	4-1/2"	6"	3/4"	10
65117	3/8"	2"	2-1/4"	4"	1"	10
65118	3/8"	3"	3-1/4"	5"	1"	10
65119	3/8"	3"	4-1/4"	6"	1"	10
65120	3/8"	3"	6-1/4"	8"	1"	10
65123	1/2"	3"	3-3/4"	6"	1-1/4"	10
65124	1/2"	3"	5-3/4"	8"	1-1/4"	10

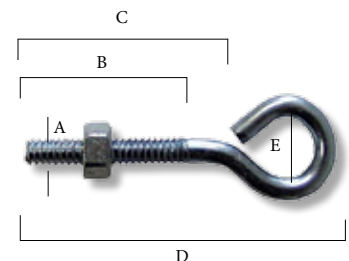

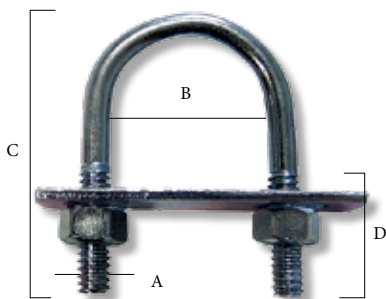

U-BOLTS

U-Bolts - Round

Supplied with 3/32" mounting plate & nuts. Clear zinc plated.
10 pieces per package. UNC threading (coarse).

PART#	A	B	C	D	THREADS/INCH	PIPE
65140	1/4"	1-1/8"	2"	1"	20	3/4"
65141	1/4"	1-3/8"	2-3/4"	1-1/4"	20	1"
65142	1/4"	2"	3-1/2"	1-3/4"	20	1-1/2"
65143	5/16"	1-3/8"	2-1/2"	1"	18	1"
65144	5/16"	1-3/8"	3-11/16"	2-3/8"	18	1"
65145	5/16"	1-3/4"	3"	1-1/2"	18	1-1/4"
65146	5/16"	1-3/4"	4-3/16"	2-3/4"	18	1-1/4"
65147	5/16"	2"	3"	1-1/2"	18	1-1/2"
65148	5/16"	2"	3-3/4"	2-1/8"	18	1-1/2"
65149	5/16"	2-1/2"	3-1/2"	1-1/2"	18	2"
65150	5/16"	2-1/2"	4-3/16"	2-3/8"	18	2"
65151	3/8"	2-1/2"	3-5/8"	1-3/4"	16	2"
65152	3/8"	3"	4-1/8"	1-3/4"	16	2-1/2"
65153	3/8"	3-1/2"	4-5/8"	2"	16	3"

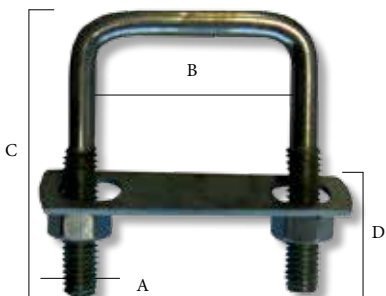

U-Bolts - Square

Supplied with 3/32" mounting plate & nuts. Clear zinc plated.
5 pieces per package.

PART#	A	B	C	D
65181	3/8"	2"	3"	1-1/2"
65182	3/8"	2"	5"	3"
65184	3/8"	4"	3"	1-1/2"
65185	3/8"	4"	5"	3"
65187	3/8"	6"	5"	3"
65188	3/8"	6"	7"	3-3/4"



RINGS

Mounting Rings

Supplied with 3/32" mounting plate & nuts. Clear zinc plated.
10 pieces per package.

PART#	DESCRIPTION	PIN DI-AMETER	THREAD LENGTH	RING I.D.	ADDITIONAL INFORMATION
65172	2-1/2" Eyebolt	3/8"	2-3/8"	2"	Mounting holes are 1/4" Diameter
65177	4-1/2" Lagscrew Eyebolt	5/16"	1-3/4"	2"	Mounting holes are 1/4" Diameter
65178	2" x 1-9/16" Mounting Plate			2"	Mounting holes are 1/4" Diameter

D-Rings

PART#	WIRE DIAMETER	A	B	PACKAGE QUANTITY
66173	1/8"	1"	7/8"	10
66174	1/8"	1-1/8"	7/8"	10
66175	5/32"	1-5/16"	1"	10
66176	5/32"	1-5/8"	1-1/8"	10

Heavy Duty D-Rings

PART#	WIRE DIAMETER	A	B	PACKAGE QUANTITY
66178	5/16"	2"	1-3/4"	10
66179	3/8"	2"	1-7/8"	10

Split Key Rings

PART#	WIRE DIAMETER	INSIDE DIAMETER	OUTSIDE DIAMETER	PACKAGE QUANTITY
66180	0.066"	5/8"	3/4"	10
66182	0.075"	27/32"	1"	10
66184	0.087"	1-5/64"	1-1/4"	10

Harness Ring

PART#	WIRE DIAMETER	INSIDE DIAMETER	OUTSIDE DIAMETER	PACKAGE QUANTITY
66390	3/16"	1-1/4"	1-5/8"	5

Welded Steel Ring

PART#	WIRE DIAMETER	INSIDE DIAMETER	OUTSIDE DIAMETER	W.L.L.	PACKAGE QUANTITY
66410	1/4"	1"	1-1/2"	325 lb	10
66411	5/16"	1-1/8"	1-3/4"	500 lb	10
66412	7/32"	1-9/16"	2"	600 lb	10

TURNBUCKLES (WIRE FORMED ENDS)

For light duty applications. Zinc die cast bodies.
Zinc plated steel wire formed ends. 10 pieces per package.

Hook & Eye

PART#	THREAD	OVERALL LENGTH CLOSED	OVERALL LENGTH OPEN	A	B	C	W.L.L.	U.L.L.
66206	7/32"	4-1/2"	6-1/2"	3/8"	5/16"	2"	120 lb	350. lb
66207	1/4"	5-3/8"	7-11/16"	7/16"	3/8"	2-3/8"	190 lb	570 lb
66208	5/16"	6-1/2"	9-5/16"	7/16"	9/16"	2-13/16"	290 lb	875 lb
66209	3/8"	7-1/2"	10-5/8"	5/8"	9/16"	3-1/8"	375 lb	1,125 lb

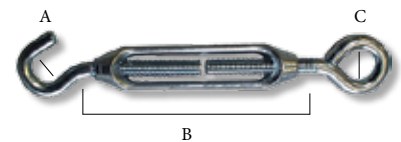
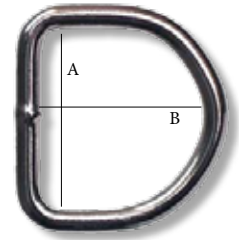

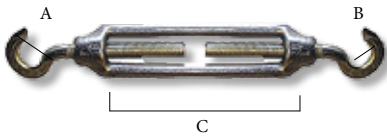

Hook & Hook

PART#	THREAD	OVERALL LENGTH CLOSED	OVERALL LENGTH OPEN	A, B	C	W.L.L.	U.L.L.
66216	7/32"	4-1/2"	6-1/2"	5/16"	2"	120 lb	350 lb
66217	1/4"	5-1/2"	7-9/16"	7/16"	2-3/8"	190 lb	570 lb
66218	5/16"	6-1/2"	6-1/4"	7/16"	2-13/16"	340 lb	1,020 lb
66219	3/8"	7"	10-5/8"	1/2"	3-1/8"	400 lb	1,200 lb

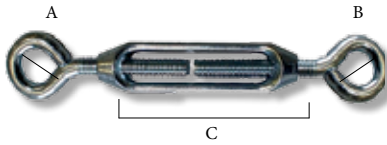

Eye & Eye

PART#	THREAD	OVERALL LENGTH CLOSED	OVERALL LENGTH OPEN	A, B	C	W.L.L.	U.L.L.
66226	3/16"	4-1/2"	6-1/2"	3/8"	2"	120 lb	350 lb
66227	1/4"	5-1/2"	7-9/16"	3/8"	2-3/8"	190 lb	570 lb
66228	5/16"	6-1/2"	9-1/4"	7/16"	2-3/4"	340 lb	1,020 lb
66229	3/8"	7"	10-5/8"	1/2"	3-1/8"	400 lb	1,200 lb

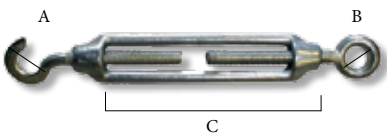

TURNBUCKLES (MALLEABLE IRON)

Malleable iron bodies and forged steel ends. Hot dipped galvanized finish.

Hook & Eye

PART#	THREAD	OVERALL LENGTH CLOSED	OVERALL LENGTH OPEN	A, B	C	W.L.L.	U.L.L.
66210	6mm	5-1/2"	8-1/4"	3/8"	2-3/4"	220 lb	660 lb
66211	8mm	6-7/8"	10-13/32"	7/16"	3-17/32"	440 lb	1,320 lb
66212	10mm	7-1/2"	11-7/16"	15/32"	3-15/16"	660 lb	1,980 lb
66213	12mm	10-1/4"	15-11/16"	19/32"	5-7/16"	1,210 lb	3,630 lb
66214	16mm	12-13/16"	20-3/32"	3/4"	7-9/32"	2,200 lb	6,600 lb
66215	20mm	15-3/4"	24"	1"	8-1/4"	3,300 lb	9,900 lb

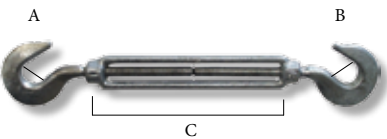

TURNBUCKLES (FORGED STEEL)

Forged steel bodies & ends. Hot dipped galvanized finish. Features a lock nut on each end. Meets Spec. FF-T791b, Type 1, Form 1, Class 5.

Hook & Hook

PART#	THREAD	OVERALL LENGTH CLOSED	OVERALL LENGTH OPEN	A, B	C	W.L.L.	U.L.L.
66800	1/4"	8"	12"	7/16"	4"	400 lb	2,000 lb
66801	5/16"	9-1/4"	13-3/4"	1/2"	4-1/2"	700 lb	3,500 lb
66802	3/8"	11-3/4"	17-3/4"	9/16"	6"	1,000 lb	5,000 lb
66803	1/2"	13-3/8"	20-3/8"	11/16"	6"	1,500 lb	7,500 lb
66804	1/2"	16-3/8"	26-3/8"	11/16"	9"	1,500 lb	7,500 lb
66805	1/2"	19-3/8"	32-3/8"	11/16"	12"	1,500 lb	7,500 lb
66806	5/8"	15-1/4"	22-1/2"	7/8"	6"	2,250 lb	11,250 lb
66807	5/8"	18-1/4"	28-1/2"	7/8"	9"	2,250 lb	11,250 lb
66808	5/8"	21-1/4"	34-1/2"	7/8"	12"	2,250 lb	11,250 lb
66809	3/4"	17-1/4"	24-3/4"	1"	6"	3,000 lb	15,000 lb
66810	3/4"	20-1/4"	30-3/4"	1"	9"	3,000 lb	15,000 lb
66811	3/4"	23-1/4"	36-3/4"	1"	12"	3,000 lb	15,000 lb

Hook & Eye

Meets Spec. FF-T791b, Type 1, Form 1, Class 6.

PART#	THREAD	OVERALL LENGTH CLOSED	OVERALL LENGTH OPEN	A	B	C	W.L.L.	U.L.L.
66820	1/4"	8"	12"	11/32"	7/16"	3-3/4"	400 lb	2,000 lb
66821	5/16"	9-1/2"	13-1/2"	7/16"	1/2"	4-1/2"	700 lb	3,500 lb
66822	3/8"	12"	18"	17/32"	9/16"	6"	1,000 lb	5,000 lb
66823	1/2"	13-5/8"	20-5/8"	23/32"	11/16"	6"	1,500 lb	7,500 lb
66824	1/2"	16-5/8"	26-5/8"	23/32"	11/16"	9"	1,500 lb	7,500 lb
66825	1/2"	19-5/8"	32-5/8"	23/32"	11/16"	12"	1,500 lb	7,500 lb
66826	5/8"	15-1/2"	22-3/4"	7/8"	29/32"	6"	2,250 lb	11,250 lb
66827	5/8"	18-1/2"	28-3/4"	7/8"	29/32"	9"	2,250 lb	11,250 lb
66828	5/8"	21-1/2"	34-3/4"	7/8"	29/32"	12"	2,250 lb	11,250 lb
66829	3/4"	17-1/2"	25"	1"		6"	3,000 lb	15,000 lb
66880	3/4"	20-1/2"	31"	1"		9"	3,000 lb	15,000 lb
66881	3/4"	23-1/2"	31"	1"		12"	3,000 lb	15,000 lb

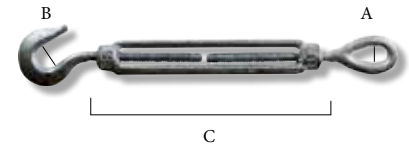

Eye & Eye

Meets Spec. FF-T791b, Type 1, Form 1, Class 4.

PART#	THREAD	OVERALL LENGTH CLOSED	OVERALL LENGTH OPEN	A,B	C	W.L.L.	U.L.L.
66830	1/4"	8-1/4"	12-1/4"	11/32"	4"	500 lb	2,500 lb
66831	5/16"	9-5/8"	14-1/8"	7/16"	4-1/2"	800 lb	4,000 lb
66832	3/8"	12-1/8"	18-1/8"	17/32"	6"	1,200 lb	6,000 lb
66833	1/2"	14"	21"	23/32"	6"	2,200 lb	11,000 lb

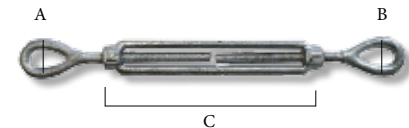

Jaw & Jaw

Meets Spec. FF-T791b, Type 1, Form 1, Class 6.

PART#	THREAD	OVERALL LENGTH CLOSED	OVERALL LENGTH OPEN	A,B	C	W.L.L.	U.L.L.
66840	1/4"	8"	12"	7/16"	4"	500 lb	2,500 lb
66841	5/16"	9-1/2"	14"	1/2"	4-1/2"	800 lb	4,000 lb
66842	3/8"	11-3/8"	17-3/8"	17/32"	6"	1,200 lb	6,000 lb
66843	1/2"	13"	20"	21/32"	6"	2,200 lb	11,000 lb
66844	1/2"	16"	26"	21/32"	9"	2,200 lb	11,000 lb
66845	1/2"	19"	32"	21/32"	12"	2,200 lb	11,000 lb
66846	5/8"	14-7/8"	22-1/8"	25/32"	6"	3,500 lb	17,500 lb
66847	5/8"	17-7/8"	28-1/8"	25/32"	9"	3,500 lb	17,500 lb
66848	5/8"	20-7/8"	34-1/8"	25/32"	12"	3,500 lb	17,500 lb
66849	3/4"	16-5/8"	24-1/8"	15/16"	6"	5,200 lb	26,000 lb
66850	3/4"	19-5/8"	30-1/8"	15/16"	9"	5,200 lb	26,000 lb
66851	3/4"	22-5/8"	36-1/8"	15/16"	12"	5,200 lb	26,000 lb

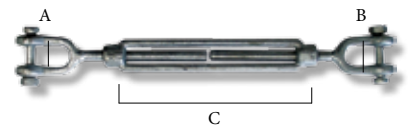

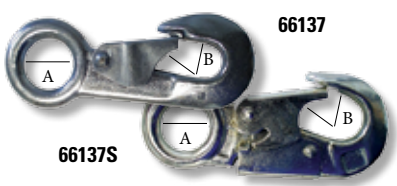

66137S



SNAPS

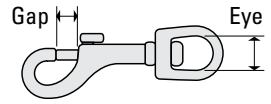

Stainless Steel Bolt Snaps

PART#	EYE INSIDE DIAMETER	GAP	OVERALL LENGTH	PACKAGE QUANTITY
64100	1/2"	9/32"	3-3/16"	5
64101	3/4"	11/32"	3-1/2"	5

Stainless Steel Security Snaps

PART#	EYE INSIDE DIAMETER	GAP	OVERALL LENGTH	W.L.L.	PACKAGE QUANTITY
64102	5/8"	3/8"	3-3/8"	100 lb	5
64103	3/4"	1/2"	3-7/8"	200 lb	5
64104	7/8"	1/2"	4-5/8"	300 lb	5

Stainless Steel Spring Snaps

PART#	EYE INSIDE DIAMETER	OVERALL LENGTH	PACKAGE QUANTITY
64105	1/4"	1-7/8"	5
64106	3/8"	2-5/8"	5
64107	1/2"	3-7/8"	5

Stainless Steel Boat Snaps

PART#	EYE INSIDE DIAMETER	GAP	OVERALL LENGTH	PACKAGE QUANTITY
64108	1/2"	1/4"	2"	5
64109	5/8"	7/16"	2-3/4"	5
64110	3/4"	9/16"	3-1/4"	5
64111	3/4"	5/8"	3-7/8"	5

Safety Lanyard Snaps

PART#	TYPE	A	B	W.L.L.	U.L.L.
66137	Single latch	1-1/16"	3/4"	1,000 lb	5,000 lb
66137S	Double latch	1-1/16"	1"	1,000 lb	5,000 lb

Bull Snap

Zinc die cast and nickel plated.

PART#	EYE INSIDE DIAMETER	GAP	OVERALL LENGTH	PACKAGE QUANTITY
66330	1"	5/8"	4-1/8"	5

Solid Snap Hook

Forged steel.

PART#	EYE INSIDE DIAMETER	GAP	OVERALL LENGTH	PACKAGE QUANTITY
66331	11/16"	5/8"	3-1/2"	5

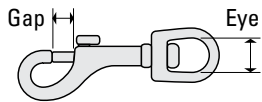

Cap Snap

Zinc plated.

PART#	EYE INSIDE DIAMETER	GAP	OVERALL LENGTH	PACKAGE QUANTITY
66332	1"	3/8"	3-5/8"	5



Swivel Eye Snaps

Zinc plated.

PART#	EYE INSIDE DIAMETER	GAP	OVERALL LENGTH	PACKAGE QUANTITY
66334	3/4"	7/16"	3-1/4"	5
66335	7/8"	7/16"	3-1/2"	5



Dog Lead Snap

Zinc plated.

PART#	EYE INSIDE DIAMETER	GAP	OVERALL LENGTH	PACKAGE QUANTITY
66336	3/8"	1/4"	2-1/2"	5



Panic Snap

Zinc plated.

PART#	EYE INSIDE DIAMETER	GAP	OVERALL LENGTH	PACKAGE QUANTITY
66338	1"	1/2"	4-1/16"	5



Trigger Snaps

Zinc plated.

PART#	EYE INSIDE DIAMETER	GAP	OVERALL LENGTH	PACKAGE QUANTITY
66339	5/8"	1/2"	2-1/2"	5
66344	3/4"	1/2"	2-3/4"	5
66348	3/4"	3/8"	2-1/2"	5
66349	3/4"	1"	3-1/2"	5
66350	3/4"	3/4"	3-7/8"	5



Bolt Snaps

Zinc plated.

PART#	EYE INSIDE DIAMETER	GAP	OVERALL LENGTH	PACKAGE QUANTITY
66340	1/2"	11/16"	3-3/8"	5
66343	1/2"	3/4"	3-1/2"	5
66354	1/4"	7/16"	2-1/8"	5
66342	3/8"	7/16"	3-1/2"	5



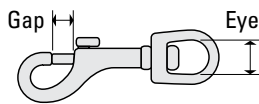

Bolt Snaps

Solid Brass.

PART#	EYE INSIDE DIAMETER	GAP	OVERALL LENGTH	PACKAGE QUANTITY
66360	1/2"	9/16"	3"	5

Bolt Snaps

Brass.

PART#	EYE INSIDE DIAMETER	GAP	OVERALL LENGTH	PACKAGE QUANTITY
66361	1"	1/2"	3-1/2"	5

Bolt Snaps

Nickel Plated.

PART#	EYE INSIDE DIAMETER	GAP	OVERALL LENGTH	PACKAGE QUANTITY
66366	9/16"	3/4"	3-1/4"	5

Open Eye Snaps

Zinc Plated.

PART#	EYE INSIDE DIAMETER	GAP	OVERALL LENGTH	PACKAGE QUANTITY
66341	13/16"	1/2"	3-9/16"	5

Loop Snaps

Zinc Plated.

PART#	EYE INSIDE DIAMETER	GAP	OVERALL LENGTH	PACKAGE QUANTITY
66346	3/4"	1/2"	3-1/8"	5
66347	1"	1/2"	2-15/16"	5

Swivel Loop Snaps

Nickel Plated.

PART#	EYE INSIDE DIAMETER	GAP	OVERALL LENGTH	PACKAGE QUANTITY
66352	3/4"	3/8"	3-1/4"	5
66353	1"	3/8"	3-1/4"	5

Open Decoy Snaps

Zinc Die Cast.

PART#	EYE INSIDE DIAMETER	GAP	OVERALL LENGTH	PACKAGE QUANTITY
66355	1/2"	1/4"	2-1/2"	5

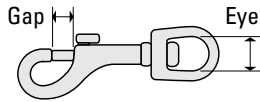

Spring Snap

Zinc Die Cast.

PART#	EYE INSIDE DIAMETER	GAP	OVERALL LENGTH	PACKAGE QUANTITY
66351	1"	7/16"	3-1/8"	5

Baby Square Eye Snaps

PART#	EYE INSIDE DIAMETER	GAP	OVERALL LENGTH	PACKAGE QUANTITY
66365	5/8"	1/4"	1-7/8"	5

Swivel Snaps

Zinc.

PART#	EYE INSIDE DIAMETER	SNAP EYE	OVERALL LENGTH	PACKAGE QUANTITY
66367	1/2"	--	2"	5
66368	5/8"	--	2-7/16"	5
66369	3/4"	--	2-5/8"	5
66370	1"	--	3"	5
66371	3/8"	--	1-3/4"	5
66372	3/8"	11/16"	2-3/8"	5

Lever Snaps

Nickel Plated.

PART#	EYE INSIDE DIAMETER	GAP	OVERALL LENGTH	PACKAGE QUANTITY
66374	5/8"	1/2"	3-1/4"	5
66375	3/4"	7/16"	3-1/2"	5
66376	1"	3/8"	3-1/2"	5
66377	1-1/8"	9/16"	4-7/16"	5

Security Snaps

PART#	EYE INSIDE DIAMETER	GAP	OVERALL LENGTH	PACKAGE QUANTITY
66380	7/8"	9/16"	3-7/8"	5
66381	1"	9/16"	5-1/16"	5

Swivel Security Snaps

PART#	EYE INSIDE DIAMETER	GAP	OVERALL LENGTH	PACKAGE QUANTITY
66394	1"	1"	4-1/8"	5

Eye Bull Snaps

Nickel Plated.

PART#	EYE INSIDE DIAMETER	GAP	OVERALL LENGTH	PACKAGE QUANTITY
66385	3/4"	9/16"	3-3/4"	5



66367



66371



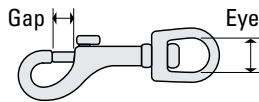

Flat Spring Snap - Simplex

PART#	EYE INSIDE DIAMETER	GAP	OVERALL LENGTH	PACKAGE QUANTITY
66356	11/16"	5/16"	4-3/8"	5
66387	1/2"	1/4"	2-3/4"	5



Bronze Animal Snap

PART#	EYE INSIDE DIAMETER	GAP	OVERALL LENGTH	PACKAGE QUANTITY
66392	1"	9/16"	4-1/2"	5



Steel Snap Links

Formed steel with clear zinc plated finish.

PART#	WIRE DIAMETER	GAP	LENGTH	W.L.L.	U.L.L.	PACKAGE QUANTITY
66419	3/16"	1/4"	2"	220 lb	550 lb	10
66420	1/4"	5/16"	2-3/8"	260 lb	650 lb	10
66421	5/16"	3/8"	3-1/8"	500 lb	1,250 lb	10
66422	3/8"	1/2"	4"	770 lb	1,925 lb	10
66425	7/16"	5/8"	4-3/4"	900 lb	2,250 lb	5
66426	1/2"	3/4"	5-3/8"	1,200 lb	3,000 lb	5



Aluminium Snap Links

For decorative and light applications. Multicoloured.

PART#	WIRE DIAMETER	GAP	LENGTH	PACKAGE QUANTITY
66427	3/16"	1/2"	1-5/16"	10
66428	1/4"	5/8"	2-7/16"	10
66429	5/16"	7/8"	3-1/8"	10



Stainless Steel Snap Links

304 Stainless steel material.

PART#	WIRE DIAMETER	GAP	LENGTH	W.L.L.	PACKAGE QUANTITY
64070	3/16"	1/4"	1-15/16"	100 lb	5
64071	1/4"	5/16"	2-3/8"	140 lb	5
64072	5/16"	3/8"	3-1/8"	250 lb	5
64073	3/8"	1/2"	4"	400 lb	5

WEATHER CAPS AND MUFFLER CLAMPS

Weather Caps

Clear zinc plated steel. Single bolt installation, silencer block, heat resistant rivets and bushings.

PART#	FITS PIPE DIAMETER	PART#	FITS PIPE DIAMETER
11200	1-1/2" – 1-11/16"	11206	3" – 3-3/16"
11201	1-3/4" – 1-15/16"	11207	3-1/2" – 3-11/16"
11202	2" – 2-3/16"	11208	4" – 4-3/16"
11203	2-1/4" – 2-7/16"	11209	4-1/2" – 4-11/16"
11204	2-1/2" – 2-11/16"	11210	5" – 5-1/4"
11205	2-3/4" – 2-15/16"		



Universal Tail Pipe Hanger

PART#	DESCRIPTION
11220	Open end design for use with assembled clamps.



Muffler Clamps

Clear zinc plated. 3/8" (8.3 mm) wire diameter.

PART#	SIZE	PART#	SIZE	PART#	SIZE
11225	1-1/2"	11231	2-1/4"	11236	4"
11226	1-5/8"	11232	2-1/2"	11237	4-1/2"
11227	1-3/4"	11233	2-3/4"	11238	5"
11228	1-7/8"	11234	3"	11239	5-1/2"
11229	2"	11235	3-1/2"	11240	6"
11230	2-1/8"				



STROKE CONTROL HARDWARE

For air & hydraulic cylinders. Cast aluminum alloy.

Stroke Control Segment Kits

PART#	FITS SHAFT DIAMETER	SPACER WIDTH (1 EACH)	PACKAGING
55000	1-1/8" to 1-1/4"	3/4", 1", 1-1/4" & 1-1/2"	Clamshell
55001	1-3/8" to 1-1/2"	3/4", 1", 1-1/4" & 1-1/2"	Clamshell
55002	2"	1", 1-1/2", 2", 4-1/4"	Polybag



Stroke Control Segments

PART#	FITS SHAFT DIAMETER	WIDTH	PART#	FITS SHAFT DIAMETER	WIDTH
55003	1-1/8" – 1-1/4"	3/4"	55009	1-3/8" – 1-1/2"	1-1/4"
55004	1-1/8" – 1-1/4"	1"	55010	1-3/8" – 1-1/2"	1-1/2"
55005	1-1/8" – 1-1/4"	1-1/4"	55011	2"	1"
55006	1-1/8" – 1-1/4"	1-1/2"	55012	2"	1-1/2"
55007	1-3/8" – 1-1/2"	3/4"	55013	2"	2"
55008	1-3/8" – 1-1/2"	1"	55014	2"	4-1/4"





Stroke Control Stopper Blocks

PART#	SIZE	FITS SHAFT DIAMETER
56006	1/2"	1" to 1-1/2"
56010	3/8"	1-1/2" to 2"



Cylinder Pins

For air & hydraulic cylinders. Supplied with clips.
10-35 stress proof steel with #66311 Hair Pin

PART#	PIN DIAMETER	USABLE LENGTH
55030	1"	2-3/4"
55031	1"	3"



Tractor Drawbar Hook

Forged steel. Black enamel painted body & zinc plated T-Pin.
Supplied with #66305 Hair Pin.

PART#	CHAIN	A	PIN DIAMETER	PIN LENGTH	OVERALL LENGTH	W.L.L.
66040	5/16"-1/2"	1-5/8"	3/4"	3"	7"	9,200 lb

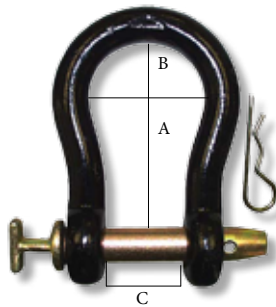

Straight Clevises

Forged steel. Black enamel painted body & zinc plated T-Pin.
Supplied with Hair Pin.

PART#	BODY DIAMETER	PIN DIAMETER	A	B	C	W.L.L.	U.L.L.
66029	5/8"	1/2"	3-1/4"	2"	7/8"	6,000 lb	18,000 lb
66030	3/4"	5/8"	3-3/4"	2-1/4"	1-5/16"	12,000 lb	36,000 lb
66031	7/8"	3/4"	4-1/4"	2-3/4"	1-5/16"	16,000 lb	48,000 lb
66032	15/16"	7/8"	4-5/8"	3-1/8"	1-7/16"	20,000 lb	60,000 lb
66033	1"	1"	5-5/16"	3-5/16"	2-1/8"	25,000 lb	75,000 lb



Steering Wheel Spinners

Vinyl coated aluminum knob with chrome plated base.
Ball bearing insert for long life.
Safe and easy for use with most off-road vehicles.
Not for highway use.

PART#	COLOR	QUANTITY
28327	Red	12 pieces per display box
28329	Black	12 pieces per display box

PINS

Industrial Safety Pins

Oil tempered steel. Clear zinc plated finish.

PART#	WIRE	A	B	PACKAGE QUANTITY
66470	1/8"	3-1/8"	1-1/16"	10
66472	3/16"	3-3/8"	1-1/2"	5
66474	1/4"	5-1/4"	1-3/4"	5
66489	3/32"	1-11/16"	5/8"	10
66490	1/8"	2-13/16"	13/16"	10
66491	3/16"	3"	1-1/2"	5
66492	5/32"	3-3/4"	1-1/8"	5
66493	15/64"	5"	1-5/8"	5
66494	15/64"	5"	2-1/4"	5

Wire Ring Quick Release Pins

Spring-loaded ball locks pin into place.
C-1144 zinc plated carbon steel pin (detent pin).

PART#	A	B	PACKAGE QUANTITY	PART#	A	B	PACKAGE QUANTITY
66499	1/4"	1"	5	66515	3/8"	1-1/2"	5
66500	1/4"	1-1/2"	5	66516	3/8"	2"	5
66501	1/4"	2"	5	66518	3/8"	2-1/2"	5
66503	1/4"	2-1/2"	5	66519	3/8"	3"	5
66505	1/4"	3"	5	66520	3/8"	3-1/2"	5
66507	5/16"	1"	5	66524	1/2"	1"	5
66508	5/16"	1-1/2"	5	66525	1/2"	1-1/2"	5
66509	5/16"	2"	5	66526	1/2"	2"	5
66510	5/16"	2-1/2"	5	66527	1/2"	2-1/2"	5
66511	5/16"	3"	5	66528	1/2"	3"	5
66514	3/8"	1"	5	66530	1/2"	3-1/2"	5

Quick Release Pins

Red vinyl coated, solid handle.

PART#	A	B	PART#	A	B
66760	1/2"	3"	66767	5/8"	5"
66762	5/8"	1-1/2"	66768	3/4"	1-1/2"
66763	5/8"	2"	66769	3/4"	2"
66764	5/8"	2-1/2"	66770	3/4"	2-1/2"
66765	5/8"	3"	66771	3/4"	3"
66766	5/8"	4"	66772	3/4"	4"
			66773	3/4"	5"

Hitch Pin - Round Ring Grip

C-1144 high strength stress-proof steel. Clear zinc plated finish.
Supplied with hair pin clip.

PART#	PIN DIAMETER (A)	USABLE LENGTH (B)	HAIR PIN CLIP
66250	3/8"	3"	66301

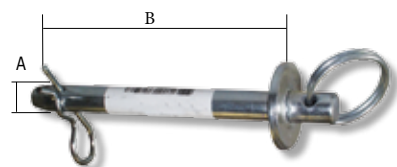
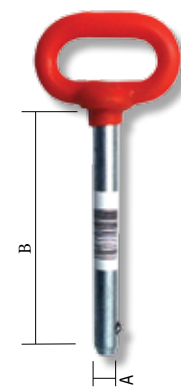
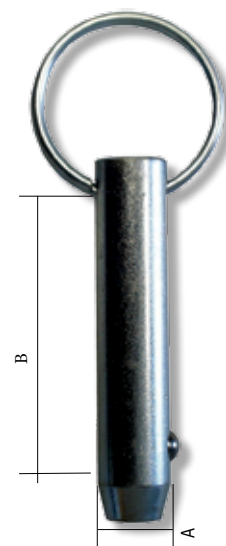
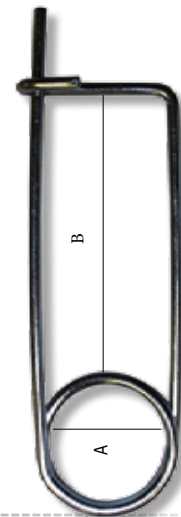

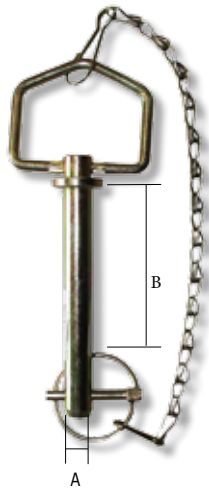

Fold Over Handle With Chain

C-1045 stress-proof steel. Heat-treated. Rockwell hardness 25-34 (HRC) Yellow zinc dichromate plated finish. Supplied with 66451 linch pin & tenso chain.

PART#	PIN DIAMETER (A)	USABLE LENGTH (B)	M.B.L. (MIN. BREAK LOAD)
66280	1/2"	4-1/4"	20,100 lb
66281	5/8"	4-1/4"	28,400 lb
66282	5/8"	6-1/4"	28,400 lb
66283	3/4"	4-1/4"	40,000 lb
66284	3/4"	6-1/4"	40,000 lb
66285	7/8"	6-1/4"	58,364 lb
66286	1"	6-1/4"	81,170 lb
66287	1-1/8"	6-1/4"	97,701 lb
66288	1-1/4"	6-1/4"	124,198 lb

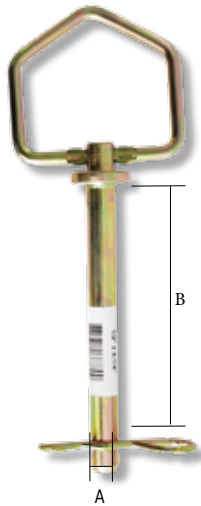

Fold Over Handle

C-1045 stress-proof steel. Heat-treated. Rockwell Hardness 25-34 (HRC) Yellow zinc dichromate plated finish. Supplied with hair pin.

PART#	PIN DIAMETER (A)	USABLE LENGTH (B)	M.B.L. (MIN. BREAK LOAD)	HAIR PIN CLIP #
66780	1/2"	4-1/4"	20,100 lb	66303
66781	5/8"	4-1/4"	28,400 lb	66305
66782	5/8"	6-1/4"	28,400 lb	66305
66783	3/4"	4-1/4"	40,000 lb	66302
66784	3/4"	6-1/4"	40,000 lb	66302
66785	7/8"	6-1/4"	58,364 lb	66302
66786	1"	6-1/4"	81,170 lb	66304
66787	1-1/8"	6-1/4"	97,701 lb	66304
66788	1-1/4"	6-1/4"	124,198 lb	66304



HITCH PINS

E-Grip

One piece solid hot forged alloy steel pin and handle. Wider ergonomic handle. Clip pin is included. Bright orange powder coat finish.

PART#	PIN DIAMETER (A)	USABLE LENGTH (B)	HAIR PIN CLIP #
66872	1/2"	3-1/2"	66303
66873	5/8"	3-3/4"	66305
66874	3/4"	4"	66302
66875	5/8"	6"	66305
66876	3/4"	6-1/4"	66302
66877	7/8"	6-1/2"	66304
66878	1"	6-3/4"	66304

High Strength Hitch Pins - Grade 5

C-1144 stress-proof steel. Double heat-treated Grade 5 specification. Rockwell Hardness 29-34 (HRC). Black powder-coated enamel pin. Red vinyl dipped handle. Supplied with hair pin clip.

PART#	PIN DIAMETER (A)	USABLE LENGTH (B)	MIN. BREAK LOAD	HAIR PIN CLIP #
66251	1/2"	3-5/8"	23,750 lb	66303
66252	5/8"	4"	41,700 lb	66305
66253	3/4"	4-1/2"	57,850 lb	66302
66254	7/8"	4-1/2"	64,680 lb	66304
66255	1"	4-1/2"	88,500 lb	66304
66256	5/8"	5-1/2"	32,940 lb	66305
66257	3/4"	6-1/2"	36,890 lb	66302
66258	7/8"	6-1/2"	71,350 lb	66302
66259	1"	7-1/2"	99,230 lb	66304
66260	1-1/8"	8-1/2"	119,440 lb	66304
66261	1-1/4"	8-1/2"	151,832 lb	66304
66263	1-1/2"	8-1/2"	191,405 lb	66304
66886	1"	12"		66304
66887	1-1/8"	12"		66304
66888	1-1/4"	12"		66304
66889	1-1/2"	13"		66304
66890	1-3/4"	13"		66455

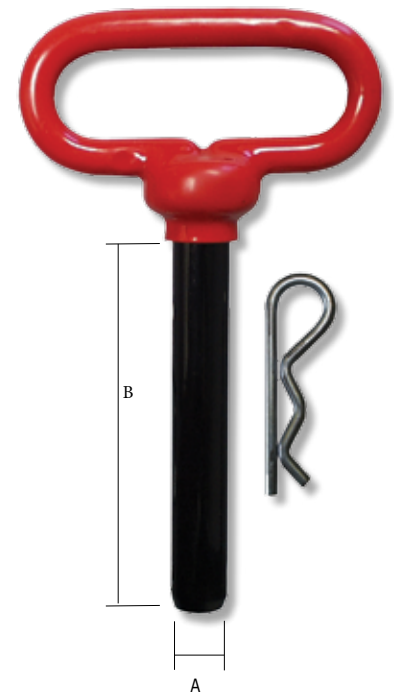

High Strength Hitch Pins - Grade 8

Grade 8 forged blue head hitch pins. Chromium and molybdenum alloy steel and heat treated to Grade 8 specification. Superior black powder coated finish on pin. Blue vinyl coating on head and handle. Hair pin clip is included.

PART#	PIN DIAMETER (A)	USABLE LENGTH (B)	HAIR PIN CLIP #
66860	1/2"	3-5/8"	66303
66861	5/8"	4"	66305
66862	5/8"	6"	66305
66863	3/4"	4"	66302
66864	3/4"	6-1/2"	66302
66865	7/8"	4-1/4"	66304
66866	7/8"	6-1/2"	66304
66867	1"	4-3/4"	66304
66868	1"	7"	66304
66869	1-1/8"	7"	66304
66870	1-1/4"	7"	66304
66871	1-1/2"	8-1/2"	66304

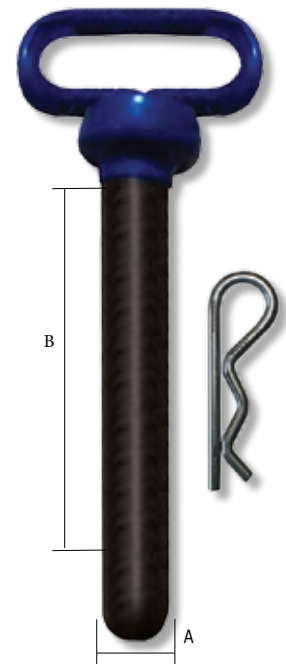

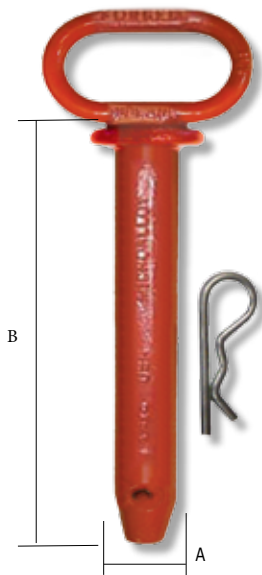

Forged Steel Hitch Pins

Hot forged, heat treated Grade 8, SAE-1541H steel. Solid handle. Bright orange powder coat finish. Supplied with clip.

PART#	PIN DIAMETER (A)	USABLE LENGTH (B)	HAIR PIN CLIP #
66882	1-1/8"	7"	66304
66883	1-1/4"	7"	66304
66884	1-3/8"	7"	66304
66885	1-1/2"	8"	66304
66886	1"	12"	66304
66887	1-1/8"	12"	66304
66888	1-1/4"	12"	66304
66889	1-1/2"	13"	66304
66890	1-3/4"	13"	66455

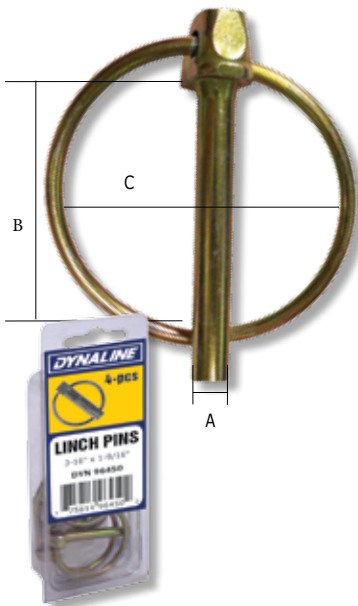

ASSORTED PINS

Linch Pins - 4 Per Pack

Forged C-1010 steel pin. Rockwell hardness RA 50-60. Yellow zinc dichromate plated finish.

PART#	PIN DIAMETER (A)	USABLE LENGTH (B)	RING DIAMETER (C)	PACKAGE QUANTITY	DYNAPAK
66450	3/16"	1-1/8"	1-3/8"	10	96450
66451	1/4"	1-1/2"	1-11/16"	10	96451
66452	5/16"	1-7/16"	1-3/4"	10	96452
66453	3/8"	1-7/16"	1-11/16"	10	96453
66454	7/16"	1-9/16"	1-5/8"	10	96454
66455	7/16"	1-7/8"	2-1/8"	10	96455

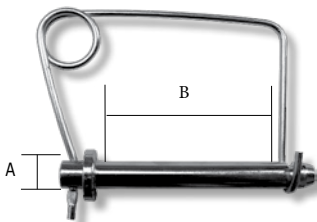

Spring Lock Pins

C-1144 stress-proof steel. Clear zinc plated finish.

PART#	PIN DIAMETER (A)	USABLE LENGTH (B)	PART#	PIN DIAMETER (A)	USABLE LENGTH (B)
66244	1/2"	4-1/4"	66247	3/4"	6-1/4"
66245	5/8"	4-1/4"	66248	7/8"	6-1/4"
66246	3/4"	4-1/4"	66249	1"	6-1/4"

QUICK PINS

C-10105 Grade 5 steel. Clear zinc plated finish.

Round Quick Pins

PART#	PIN DIAMETER (A)	USABLE LENGTH (B)	C	D	PACKAGE QUANTITY	DYNAPAK	PACKAGE QUANTITY
66460	1/4"	1-3/8"	1-5/8"	1-5/8"	5	96460	2
66461	1/4"	1-3/4"	1-5/8"	2"	5	96461	2
66463	5/16"	1-3/8"	1-5/8"	1-5/8"	5	96463	2
66464	5/16"	1-3/4"	1-5/8"	2"	5	96464	2
66466	3/8"	1-3/8"	1-5/8"	1-5/8"	5	96466	2
66469	5/8"	3-1/8"	2"	3-1/2"	5	96469	1



Square Quick Pins

PART#	PIN DIAMETER (A)	USABLE LENGTH (B)	C	D	PACKAGE QUANTITY	DYNAPAK	PACKAGE QUANTITY
66462	1/4"	2-1/2"	1-5/8"	2-3/4"	5	96462	2
66465	5/16"	2-1/2"	1-5/8"	2-3/4"	5	96465	2
66467	3/8"	2-1/4"	1-5/8"	2-1/2"	5	96467	2
66468	3/8"	2-1/2"	1-5/8"	2-3/4"	5	96468	2

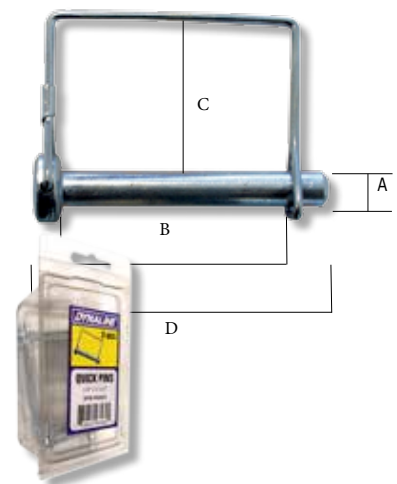

Round Tab Type Quick Pins

Easier to use than standard wire lock pins. C-1010 steel. Clear zinc plated finish.

PART#	PIN DIAMETER (A)	USABLE LENGTH (B)	C	D	PACKAGE QUANTITY
66531	1/4"	1-5/8"	1-5/8"	2-1/8"	5
66532	1/4"	2"	1-5/8"	2-3/16"	5
66533	1/4"	2-3/4"	1-5/8"	3-1/8"	5
66534	5/16"	1-5/8"	1-5/8"	2-1/8"	5
66535	5/16"	2"	1-5/8"	2-3/16"	5
66536	5/16"	2-3/4"	1-5/8"	3-1/8"	5
66537	3/8"	1-5/8"	1-5/8"	2-1/2"	5
66538	3/8"	2-1/2"	1-5/8"	2-11/16"	5
66539	3/8"	2-3/4"	1-5/8"	3-1/8"	5

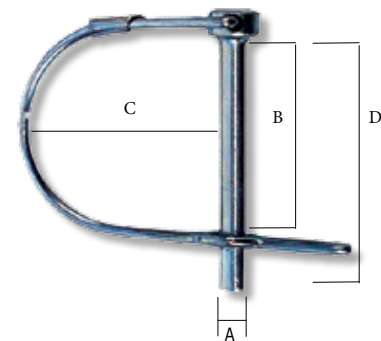

HAIR PIN CLIPS

Internal

Oil tempered MB spring wire. Clear zinc plated finish.

PART#	IND.#	WIRE DIAMETER	DRILL HOLE SIZE	MIN. SHAFT DIAMETER	MAX. SHAFT DIAMETER	OVERALL LENGTH	INSIDE EYE DIAMETER	PACKAGE QUANTITY	DYNAPAK	PACKAGE QUANTITY
66300	22	1/16"	5/64"	1/4"	1/2"	1-3/8"	1/4"	25	96300	10
66301	3	3/32"	7/64"	1/4"	1/2"	1-11/16"	7/16"	25	96301	10
66302	6	3/16"	3/16"	5/8"	1"	3-1/4"	7/8"	25	96302	4
66303	7	3/32"	7/64"	3/8"	5/8"	2-5/16"	5/8"	25	96303	10
66304	8	3/16"	3/16"	7/8"	1-1/4"	3-3/4"	7/8"	25	96304	5
66305	9	5/32"	5/32"	3/4"	1-1/8"	3-5/16"	3/4"	25	96305	5
66306	11	1/8"	9/64"	7/16"	3/4"	2-5/8"	9/16"	25	96306	5
66307	16	1/8"	9/64"	1/2"	3/4"	2"	1/2"	25	96307	10
66308	19	1/4"	17/64"	3/4"	1"	4-1/4"	3/4"	10	96308	3
66309	1	5/32"	5/32"	1/2"x5/8"	5/8"x1"	3"	1/2"	25	96300	10
66310	2	1/8"	9/64"	3/4"	1-1/8"	3-1/4"	1"	25	96301	10
66313	4	11/64"	3/16"	1/2"x3/4"	5/8"x1"	3"	5/8"	25	96302	4
66317	17	3/32"	3/32"	3/8"	1/2"	1-9/16"	5/16"	25	96303	10
66318	18	1/16"	5/64"	3/8"	1/2"	1-9/16"	5/16"	25	96304	5
66320	20	5/16"	21/64"	7/8"	1"	4"	7/8"	10	96305	5
66325	25	5/64"	5/64"	5/16"	3/8"	1-3/32"	9/64"	25	96306	5
66326	10	5/32"	5/32"	5/8"	1"	2-15/16"	3/4"	25	96307	10
66328	14	3/32"	7/64"	1/2"	3/4"	2-1/2"	5/8"	25	96308	3



External

Oil tempered MB spring wire. Clear zinc plated finish.

PART#	IND.#	WIRE DIAMETER	OVERALL LENGTH	INSIDE EYE DIAMETER	PACKAGE QUANTITY	DYNAPAK	PACKAGE QUANTITY
66311	7XX	7/64"	2-1/16"	7/16"	25	96311	5
66312	10X	11/64"	2-5/8"	3/4"	25	96312	4

BUSHINGS

Bronze Bushings

S.A.E. 841 Bronze material. Oil impregnated.

PART#	THICKNESS	INNER DIAM-ETER	OUTER DIAM-ETER	LENGTH	PART#	THICKNESS	INNER DIAM-ETER	OUTER DIAM-ETER	LENGTH
55300	1/32"	1/4"	5/16"	3/4"	55326	1/16"	7/8"	1"	1-1/4"
55301	1/16"	1/4"	3/8"	1"	55327	1/8"	7/8"	1-1/8"	1-1/4"
55302	3/32"	1/4"	7/16"	1"	55328	3/16"	7/8"	1-1/4"	1-1/4"
55303	1/8"	1/4"	1/2"	1"	55329	5/32"	15/16"	1-1/4"	1-1/4"
55304	1/32"	5/16"	3/8"	1"	55330	1/8"	1"	1-1/4"	1-1/2"
55305	1/16"	5/16"	7/16"	1"	55331	3/16"	1"	1-3/8"	1-1/2"
55306	1/16"	3/8"	1/2"	1"	55332	1/4"	1"	1-1/2"	1-1/2"
55307	1/8"	3/8"	5/8"	1"	55333	1/8"	1-1/16"	1-5/16"	1-1/2"
55308	3/16"	3/8"	3/4"	1"	55334	1/16"	1-1/8"	1-1/4"	1-1/2"
55309	1/16"	7/16"	9/16"	1"	55335	1/8"	1-1/8"	1-3/8"	1-1/2"
55310	3/32"	7/16"	5/8"	1"	55336	3/16"	1-1/8"	1-1/2"	1-1/2"
55311	1/16"	1/2"	5/8"	1"	55337	1/8"	1-3/16"	1-7/16"	1-1/2"
55312	3/32"	1/2"	11/16"	1"	55338	5/32"	1-3/16"	1-1/2"	1-1/2"
55313	1/8"	1/2"	3/4"	1"	55339	1/8"	1-1/4"	1-1/2"	1-1/2"
55314	5/32"	1/2"	13/16"	1"	55340	3/16"	1-1/4"	1-5/8"	1-1/2"
55315	3/16"	1/2"	7/8"	1"	55341	1/8"	1-3/8"	1-5/8"	1-1/2"
55316	3/32"	9/16"	3/4"	1"	55342	3/16"	1-3/8"	1-3/4"	1-1/2"
55317	1/8"	9/16"	13/16"	1"	55343	5/32"	1-7/16"	1-3/4"	1-1/2"
55318	1/16"	5/8"	3/4"	1-1/4"	55344	1/8"	1-1/2"	1-3/4"	1-1/2"
55319	3/32"	5/8"	13/16"	1-1/4"	55345	3/16"	1-1/2"	1-7/8"	1-1/2"
55320	1/8"	5/8"	7/8"	1-1/4"	55346	3/16"	1-5/8"	2"	1-1/2"
55321	3/16"	5/8"	1"	1-1/4"	55347	1/8"	1-3/4"	2"	1-1/2"
55322	1/16"	3/4"	7/8"	1-1/4"	55348	3/16"	1-3/4"	2-1/8"	1-1/2"
55323	3/32"	3/4"	15/16"	1-1/4"	55349	3/16"	2"	2-1/4"	1-1/2"
55324	1/8"	3/4"	1"	1-1/4"	55350	3/16"	2"	2-3/8"	1-1/2"
55325	3/32"	13/16"	1"	1-1/4"					





Lift Arm Bushings

Carbon steel. Yellow zinc dichromate plated finish.

PART#	REFERENCE#	CATEGORY	INSIDE DIAMETER	OUTSIDE DIAMETER	OVERALL LENGTH
66608	0351	1 to 2	7/8"	1-1/8"	1-3/4"
66610	3009	2 to 3	1-1/8"	1-7/16"	1-3/4"
66612	3010	2 to 3	1-1/8"	1-7/16"	2-1/2"

Top Link Bushings

Carbon steel. Yellow zinc dichromate plated finish.

PART#	REFERENCE#	CATEGORY	INSIDE DIAMETER	OUTSIDE DIAMETER	OVERALL LENGTH
66602	0353	1 to 2	3/4"	1"	2"
66604	3008	2 to 3	1"	1-1/4"	2"

ASSORTMENTS

Top Links

Carbon steel, forged & welded. With grease fitting, nut welded. Yellow zinc dichromate plated finish. UNC Coarse Thread.

PART#	REFERENCE#	CATEGORY	HOLE DIAMETER	THREAD DIAMETER	ADJUSTMENT
66619	480	0	5/8"	3/4"	11" – 16"
66620	331	1	3/4"	1-1/8"	20" – 29"
66621	338	1 & 2	3/4" & 1"	1-1/8"	21" – 33"
66622	337	2	1"	1-1/8"	25" – 35"
66623	339	1 & 2	3/4" & 1"	1-1/8"	24" – 35"
66624	336	2	1"	1-1/8"	21" – 31"
66619EM	--	0	5/8"	3/4"	11" – 11"

Top Link Repair Ends

Carbon steel, forged & welded. Yellow zinc dichromate plated finish. UNC Coarse Thread.

PART#	REFERENCE#	CATEGORY	HOLE DIAMETER	THREAD DIAMETER	THREAD LENGTH
66625	342	1	3/4"	1-1/8" LH	6"
66626	343	1	3/4"	1-1/8" RH	6"
66627	346	2	1"	1-1/8" LH	6-1/2"

Ratchet Jack

Heavy duty. Replace hydraulic cylinders or old screw jacks in those applications where infrequent adjustment is needed. Clip pins and handle included.

PART#	A	B	C	THREAD DIAMETER	LENGTH CLOSED	LENGTH EXTENDED
66642	1-1/2"	1"	2-3/4"	1-1/4"	20"	28"

Top Link Pins

Carbon steel, forged & welded. Yellow zinc dichromate plated finish. UNC Coarse Thread.

PART#	REFERENCE#	CATEGORY	PIN DIAMETER	USABLE LENGTH	OVERALL LENGTH
66560	73	1	3/4"	2-3/4"	4-1/2"
66561	74	1	3/4"	3-7/8"	5-1/2"
66562	76	2	1"	3-9/16"	5-1/4"
66563	7715	1	3/4"	4-3/4"	6-3/8"
66565	3011	2	1"	4-5/16"	6"
66566	7711	3	1/4"	4-5/8"	6-1/2"
66567	7706	0	5/8"	3"	4-7/16"



Lift Arm Pins

Carbon steel. Yellow zinc dichromate plated finish.

PART#	REFERENCE#	CATEGORY	PIN DIAMETER	THREAD DIAMETER	USABLE LENGTH	OVERALL LENGTH
66580	200	1	7/8"	7/8"	2-1/4"	5-1/2"
66581	3000	1	7/8"	7/8"	Adjustable	6-1/4"
66582	3004	1	7/8"	7/8"	2-1/4"	6-1/2"
66583	3001	1 to 2	1-1/8"	7/8"	Adjustable	5-3/16"
66584	7243	2 to 3	1-7/16"	1-1/8" NF*	1-7/8"	5-3/4"
66585	202	1 to 2	1-1/8"	7/8"	1-3/4"	5-1/4"
66586	7249	1 to 2	1-1/16"	1" NF*	1-1/8"	8"
66587	3022	2 to 1	7/8"	1-1/8"	1-3/4"	5-3/4"
66588	3006	2	1-1/8"	1-1/8"	1-3/4"	6-1/4"
66589	3002	2	1-1/8"	1-1/8"	Adjustable	6-1/4"
66590	211	1	7/8"	7/8"	Adjustable	5-5/16"
66591	7220	0	5/8"	5/8" NF*	Adjustable	3-7/8"
66592	7246	1 to 2	1-1/8"	7/8" NF*	2-1/4"	6-5/16"

*NF - National Fine



Manual Holders

Molded from high density polypropylene, weather and impact resistant. Protects documents from damage. Mounts onto machines for easy access. O-Ring sealed. Screw top lid.

PART#	DESCRIPTION
17720	2" diameter x 12-1/2" long
17730	3-1/4" diameter x 12-1/2" long
17731	Prevents lid loss on manual holders. Simply drill 5/16" hole in center of lid to attach one end of tether. The other end of tether snaps into place in center hole.





DYNALINE

Better products for all.

Bungee Products

Ratchet Straps

Cam Straps

Recovery Straps

Winches

Tarp Straps

Heavy Duty Recovery

Tow Straps

Heavy Duty Tow Ropes

Winch Bars

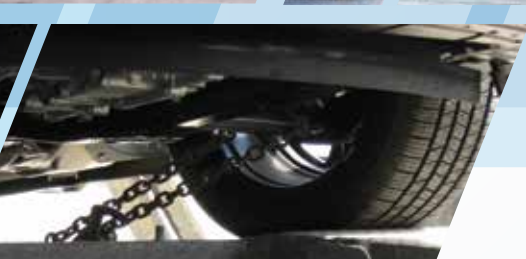

CARGO CONTROL

CARGO CONTROL

Bungee Cords

Industrial, Premium & Ultimate Bungee Cords.....	1
Bungee Packs.....	2-3
Bungee Reel	3
Bungee Balls, Hook & Cargo Nets	4

Tarp Straps & Tie Downs

Cold Weather Tarp Strap.....	4
EPDM Rubber Tarp Strap	5
Ratchet Rope Tie Downs.....	5
Cam Straps & Packs	6

Ratchet Straps

"J", "S", Flat, Ratchet Strap & Packs.....	7
"J", Flat, Ratchet Strap Bulk	8
Retractable & Soft Grip.....	8

Tow & Recovery Straps

Tow Strap w/Hooks	9
Yellow or White Recovery Strap.....	9
Heavy Duty Recovery Strap	9

Tow Ropes

Tow Ropes.....	10
Heavy Duty Tow Ropes	10

Winch Bars & Accessories

Winch Bars	11
Cargo Winch.....	11
Winch Straps	11
Corner Protector.....	11

Winch

Hand & Electric Winches.....	12-13
------------------------------	-------

Replacement Parts

Cable Keeper, Handles & Gears	14
-------------------------------------	----

Achor Points

Mounted, Recessed & Surface Anchors	14-15
--	-------

Load Tighteners

Ratchet Type Load Binders.....	16
Lever Type Load Binders.....	16
Load Tighteners	16
Load Binders Locks	16
Cable Type Load Binder Locks.....	16

BUNGEE CORDS

Used to Secure objects without tying knots and to absorb shock.

Industrial Bungee Cords

Triple the hook strength of other cords. Hardened zinc-plated wire hooks. Sturdy rubber core with a polyester sheath. Packed in poly bag with header card and UPC label.

PART#	DIAMETER	LENGTH	LOAD RATING	COLOUR	PKG. QTY.
12269	3/8"	32"	45 lb	Black	10
12270	3/8"	36"	45 lb	Black	10
12420	3/8"	13"	45 lb	Black	1
12421	3/8"	18"	45 lb	Black	1
12423	3/8"	30"	45 lb	Black	1



Premium Bungee Cords

Made from top quality, long lasting rubber. Covered with an abrasion and sunlight-resistant colored sheath. Hardened vinyl-coated wire hooks. Packed in poly bag with header card and UPC label.

PART#	DIAMETER	LENGTH	LOAD RATING	COLOUR	PKG. QTY.
12400	5/32" (Mini)	10"	7 lb	Black	4
12276	5/16"	36"	33.75 lb	Blue	10
12410	5/16"	13"	22.75 lb	Green	1
12411	5/16"	18"	22.75 lb	Blue	1
12412	5/16"	24"	22.75 lb	Red	1
12413	5/16"	30"	22.75 lb	Yellow	1
12414	5/16"	36"	33.75 lb	Orange	1



Ultimate Bungee Cords

Top quality bungee cord with colored polyester sheath and hardened rubber-coated wire hooks.

PART#	DIAMETER	LENGTH	LOAD RATING	COLOUR	PKG. QTY.
12430	3/8"	6" - 48"	33.75 lb	Silver	1
12431	3/8"	13"	33.75 lb	Green	1
12432	3/8"	18"	22.75 lb	Blue	1
12434	3/8"	30"	22.75 lb	Yellow	1
12435	3/8"	36"	22.75 lb	Orange	1





Premium Bungee Packs

The most popular sizes in an assortment pack. Premium quality bungee cords are made from long lasting rubber covered with an abrasion & sunlight-resistant sheath. Hardened vinyl-coated hooks.

Premium Bungee 8 Pack

PART#	DIAMETER	LENGTH	QTY.
12277	5/16"	13"	2
	5/16"	18"	2
	5/16"	24"	2
	5/16"	30"	2

Premium Bungee 10 Pack

PART#	DIAMETER	LENGTH	QTY.
12260	5/16"	13"	2
	5/16"	18"	2
	5/16"	24"	2
	5/16"	30"	2
	5/16"	32"	2

Premium Bungee 15 Pack

PART#	DIAMETER	LENGTH	QTY.
12261	5/16"	13"	5
	5/16"	18"	4
	5/16"	24"	4
	5/16"	36"	2



Premium Bungee Cord Assortments - 12 Pieces

A convenient selection of colored bungee cords in a transparent plastic tube with cap. Premium bungee cords are made from long lasting rubber covered with an abrasion and sunlight-resistant sheath made of colored polyester. Hardened vinyl-coated wire hooks.

PART#	DIAMETER	LENGTH	COLOUR	QTY.
12441	5/32"	10"	Red	4
	5/16"	18"	Blue	2
	5/32"	24"	Red	4
	5/16"	30"	Yellow	2



Premium Bungee Cord Assortments - 25 Pieces

A convenient selection of colored bungee cords in a transparent plastic tube with cap. Premium bungee cords are made from long lasting rubber covered with an abrasion and sunlight-resistant sheath made of colored polyester. Hardened vinyl-coated wire hooks.

PART#	DIAMETER	LENGTH	COLOUR	QTY.
12442	5/32"	10"	Purple	6
	5/16"	18"	Blue	2
	5/16"	24"	Red	2
	5/16"	30"	Yellow	2
	5/16"	36"	Orange	2
	5/16"	42"	Green	2
4 - 10" Ball, 5/32"				
4 - Adjustable Hooks				
1 - Spider Ring				

Premium Bungee Cord Assortments - 18 Pieces

A convenient selection of colored bungee cords in a clamshell package. Top quality bungee cords are made from long lasting rubber covered with an abrasion and sunlight-resistant sheath made of colored polyester. Hardened vinyl-coated wire hooks.

Dimensions: 9-3/4" L x 9-1/8" W x 3-1/8" D.

PART#	DIAMETER	LENGTH	COLOUR	QTY.
12443	5/32"	8"	Black	2
	5/32"	10"	Black	4
	5/16"	18"	Blue	2
	5/16"	24"	Red	4
	5/16"	30"	Yellow	4
	5/16"	36"	Orange	2



Ultimate Bungee Cord Assortments - 10 Pieces

A convenient selection of colored bungee cords in a clamshell package. Top quality bungee cords are made from long lasting rubber covered with an abrasion and sunlight-resistant sheath made of colored polyester. Hardened vinyl-coated wire hooks.

Dimensions: 12" L x 8-1/8" W x 3-1/2" D.

PART#	DIAMETER	LENGTH	COLOUR	QTY.
12444	5/16"	18"	Blue	2
	5/16"	24"	Red	2
	5/16"	30"	Yellow	1
	5/16"	36"	Orange	1
	5/16"	42"	Green	1
	2 - Adjustable Hooks			
1 - Spider Ring				



Bungee Cord Reels

Industrial quality, black polyester sheath with rubber core in a plastic reel.

PART#	DIAMETER	CORD LENGTH	LOAD RATED
11176	1/4"	216' (65.8 m)	55-66 lb
11177	5/16"	216' (65.8 m)	66-77 lb
11178	3/8"	200' (61 m)	77-88 lb





Bungee Balls

Great for securing hoses, cables, and tying down tarps.

PART#	DESCRIPTION
11179	6" elastic cord with plastic ball. 12 per pkg.

Bungee Cord Hooks

Fits 1/4", 5/16" and 3/8" Bungee Cords.

PART#	DESCRIPTION
11174	Fits 1/4", 5/16" and 3/8" Bungee Cords. Vinyl-coated wire hook. Wire diameter 4 mm. 10 per pkg.

Cargo Nets

Keeps smaller items stationary while driving. Elastic cords & plastic hooks.

PART#	SIZE	PKG. QTY.
12300	15" x 15"	1 ea.
12301	15" x 30"	1 ea.
12302	36" x 48"	1 ea.
12303	72" x 96" (Pick-Up)	1 ea.

NEW!



Cold Resistant Tarp Straps

These brand new Heavy Duty tarp straps are made from TPR material and supplied with two crimped zinc plated S-hooks. More Load Capacity.

PART#	LENGTH	CAPACITY	HOOKS	PKG. QTY.
11295	Heavy Duty 9"	90 lb	S Hooks	10/pkg.
11296	Heavy Duty 15"	90 lb	S Hooks	10/pkg.
11297	Heavy Duty 21"	90 lb	S Hooks	10/pkg.
11298	Heavy Duty 31"	90 lb	S Hooks	10/pkg.

Ratchet Rope Tie Downs

Pulls tight & won't slip. Easy-release thumb lever. High impact plastic housing & die cast hardware. Supplied with braided rope & hook set in a plastic packaging.

PART#	ROPE DIAMETER	ROPE LENGTH	W.LL	BOX QTY.
11284	1/4"	8'	150 lb	12
11286	3/8"	8'	250 lb	10



EPDM Rubber Tarp Straps

100% EPDM. (See chart below.) Recommended for commercial and industrial applications. Supplied with two zinc plated S-hooks assembled.

PART#	LENGTH	CAPACITY	QTY.
11191	9"	50 lb	10/pkg.
11192	15"	50 lb	10/pkg.
11193	21"	50 lb	10/pkg.
11194	31"	50 lb	10/pkg.
11299	31" adjustable	50 lb	10/pkg.



11192

EPDM (Ethylene Propylene, EPM)	Property	EPDM
<p>EPDM is a copolymer of ethylene and propylene. Ethylene-propylene-diene rubber (EPDM) is produced using a third monomer and is particularly useful when sealing phosphate-ester hydraulic fluids and in brake systems that use fluids having a glycol base.</p> <p>Heat Resistance:</p> <ul style="list-style-type: none"> ▶ Up to 300° F (149°C) (max. 400° F (204°C) in water and/or steam). <p>Cold Flexibility:</p> <ul style="list-style-type: none"> ▶ Down to approximately -70°F (-57°C). <p>Chemical Resistance:</p> <ul style="list-style-type: none"> ▶ Hot water and steam up to 300° F (149°C) with special compounds up to 400° F (204°C). ▶ Glycol based brake fluids up to 300° F (149°C). ▶ Many organic and inorganic acids. ▶ Cleaning agents, soda and potassium alkalis. ▶ Phosphate-ester based hydraulic fluids (HFD-R). ▶ Silicone oil and grease. ▶ Many polar solvents (alcohols, ketones, esters). ▶ Ozone, aging and weather resistant. <p>Not compatible with:</p> <ul style="list-style-type: none"> ▶ Mineral oil products (oils, greases and fuels). 	Abraision Resistance	GE
	Acid Resistance	G
	Chemical Resistance	E
	Cold Resistance	GE
	Dynamic Properties	GE
	Electrical Properties	G
	Flame Resistance	P
	Heat Resistance	E
	Impermeability	G
	Oil Resistance	P
	Ozone Resistance	E
	Set Resistance	GE
	Tear Resistance	GE
	Tensile Strength	GE
Water Resistance	E	
Weather Resistance	E	
<p>E - Excellent F - Fair G - Good P - Poor</p>		

NEW!



11299

Tarp Strap Replacement Hook

Industrial quality, black polyester sheath with rubber core in a plastic reel.

PART#	DESCRIPTION	QTY.
66241	3/16" clear zinc-plated S-Hook	10/pkg.
66241B	Bulk Pack	500/box





Cam Straps

Designed for quick and easy operation. High quality, weather-resistant webbing with secure stitching. Vinyl-coated, heat-treated steel hooks.

- Die cast cam buckle.
- One piece per clamshell package.

PART#	SIZE	W.L.L.	U.L.L.	COLOUR	WEBBING
11182	1" x 6'	400 lb	1,200 lb	Blue	Polyester
11185	1" x 10'	400 lb	1,200 lb	Blue	Polyester
12180	1" x 10'	100 lb	300 lb	Red	Polypropylene
12191	1" x 15'	250 lb	750 lb	Black	Polyester
12195	1" x 15'	250 lb	750 lb	Camo	Polyester

Cam Strap Twin Packs

Two Cam Straps in a clamshell package.

PART#	SIZE	W.L.L.	U.L.L.	COLOUR	WEBBING
12327	1" x 6'	250 lb	750 lb	Camo	Polyester

Cam Strap Four Packs

Four Cam Straps in a clamshell package.

PART#	SIZE	W.L.L.	U.L.L.	COLOUR	WEBBING
12331	1" x 6'	250 lb	750 lb	Red	Polyester
12332	1" x 6'	250 lb	750 lb	Black	Polyester
12333	1" x 6'	250 lb	750 lb	Camo	Polyester

Tie Down Combos

A convenient selection of multi-purpose Cam & Ratchet Straps. 4-pcs. per clamshell.

PART#	SIZE	W.L.L.	U.L.L.	COLOR	WEBBING	STRAP
12335	1" x 10'	250 lb	750 lb	Black	Polyester	Cam
	1" x 15'	400 lb	1,200 lb	Black	Polyester	Ratchet

RATCHET STRAPS

Designed for quick and easy operation. High quality, weather-resistant webbing with secure stitching and steel ratchet.

- High Carbon Steel Ratchet.
- One piece per retail package.

Ratchet Straps with S-Hooks (Vinyl-Coated)

PART#	SIZE	W.L.L.	U.L.L.	COLOUR	WEBBING
11183	1" x 15'	400 lb	1,200 lb	Blue	Polyester
12206	1" x 15'	166 lb	500 lb	Red	Polypropylene
12207	1" x 15'	166 lb	500 lb	Black	Polypropylene
12220	1" x 15'	400 lb	1200 lb	Red	Polyester
11184	1" x 20'	1,000 lb	3,000 lb	Yellow	Polyester



Ratchet Straps - Double "J" Hooks

PART#	SIZE	W.L.L.	U.L.L.	COLOUR	WEBBING
11189	1" x 15'	600 lb	1,800 lb	Blue	Polyester
12340	1" x 15'	1,000 lb	3,000 lb	Yellow	Polyester
11187	1" x 20'	1,000 lb	3,000 lb	Yellow	Polyester
12341	2" x 15'	1,300 lb	4,000 lb	Yellow	Polyester
12342	2" x 25'	1,300 lb	4,000 lb	Yellow	Polyester
12230	1-1/2" x 15'	2,200 lb	6,600 lb	Yellow	Polyester
11186	1-1/2" x 25'	2,200 lb	6,600 lb	Yellow	Polyester
11190	2" x 27'	3,300 lb	10,000 lb	Yellow	Polyester
12343	2" x 30'	3,300 lb	10,000 lb	Yellow	Polyester
12346	2" x 20'	3,300 lb	10,000 lb	Yellow	Polyester



Ratchet Straps with Flat Hooks

PART#	SIZE	W.L.L.	U.L.L.	COLOUR	WEBBING
12353	2" x 20'	3,300 lb	10,000 lb	Yellow	Polyester
12354	2" x 25'	3,300 lb	10,000 lb	Yellow	Polyester
12344	2" x 30'	3,300 lb	10,000 lb	Yellow	Polyester



Ratchet Straps with S-Hooks - Twin Packs

Two medium duty Ratchet Straps in a clamshell package. Vinyl-coated, heat-treated steel hooks.

PART#	SIZE	W.L.L.	U.L.L.	COLOUR	WEBBING
12226	1" x 6'	400 lb	1,200 lb	Black	Polyester
12228	1" x 6'	400 lb	1,200 lb	Camo	Polyester



Ratchet Straps with S-Hooks - Four Packs

Four medium duty Ratchet Straps in a clamshell package. Vinyl-coated, heat-treated steel hooks.

PART#	SIZE	W.L.L.	U.L.L.	COLOUR	WEBBING
12320	1" x 15'	400 lb	1,200 lb	Black	Polyester
12321	1" x 15'	400 lb	1,200 lb	Red	Polyester
12322	1" x 15'	400 lb	1,200 lb	Camo	Polyester



NEW!



Ratchet Straps - Bulk

High quality polyester webbing, secure stitching, steel ratchet, heat treated steel hooks, EZ Release ratchet buckle with caps.

- Comes with load rating on hardware and webbing.
- Individually shrink-wrapped.

PART#	SIZE	W.L.L.	U.L.L.	COLOR	HOOK TYPE
11183B	1" x 15'	400 lb	1,200 lb	Blue	"S", vinyl coated
11186B	1-1/2" x 15'	2,000 lb	6,000 lb	Yellow	Double "J"
11189B	1" x 15'	600 lb	1,800 lb	Blue	Double "J"
11190B	2" x 27'	3,300 lb	10,000 lb	Yellow	Double "J"
12343B	2" x 30'	3,300 lb	10,000 lb	Yellow	Double "J"
12344B	2" x 30'	3,300 lb	10,000 lb	Yellow	Flat Hook
12229B	1" x 6'	3,300 lb	10,000 lb	Yellow	Flat Hook
12353B	2" x 20'	3,300 lb	10,000 lb	Yellow	Flat Hook
12354B	2" x 25'	3,300 lb	10,000 lb	Yellow	Flat Hook



Retractable Tie Downs with Hooks

Rubber handle. Bulkpack polybags. Vinyl-coated, heat-treated steel hooks. No more loose ends!

PART#	SIZE	W.L.L.	U.L.L.	COLOR	HOOK TYPE
12370	1" x 15'	500 lb	1,500 lb	Red	"S", vinyl coated
12371	1" x 15'	500 lb	1,500 lb	Black	Double "J"

SOFT GRIP RATCHET STRAPS

Heavy duty, weather-resistant nylon webbing.

- "Soft Grip" steel ratchet.
- Steel hooks.



Soft Grip Ratchet Straps - S- Hooks

PART#	SIZE	W.L.L.	U.L.L.	COLOR
12361	1" x 15'	500 lb	1,500 lb	Red



Soft Grip Ratchet Straps - Double "J" Hooks

PART#	SIZE	W.L.L.	U.L.L.	COLOR
12363	1-1/2" x 15'	2,000 lb	6,000 lb	Yellow
12365	2" x 40'	3,500 lb	10,000 lb	Yellow

Tow Straps

Heavy duty yellow nylon webbing. Steel hook with safety latches.

PART#	SIZE	TOWING CAPACITY
11197	2" x 15'	5,000 lb
12297	2" x 15'	8,500 lb



Yellow Recovery Straps

Heavy duty yellow nylon webbing. Loop ends. Reinforced eye.

PART#	SIZE	MAX. VEHICLE WEIGHT	MAX. STRENGTH
12291	4" x 20'	17,500 lb (7,945 kg)	35,000 lb (15,890 kg)
12292	6" x 20'	27,500 lb (12,485 kg)	55,000 lb (24,970 kg)



White Recovery Straps

White polyester webbing. Reinforced loop ends.

PART#	SIZE	MAX. VEHICLE WEIGHT	MAX. STRENGTH
50915	1" x 15'	3,750 lb (1,703 kg)	7,500 lb (3,504 kg)
50920	2" x 20'	9,000 lb (4,086 kg)	18,000 lb (8,172 kg)
50921	3" x 20'	13,500 lb (6,129 kg)	27,000 lb (12,258 kg)
50922	4" x 20'	17,500 lb (7,945 kg)	35,000 lb (15,890 kg)
50930	4" x 30'	17,500 lb (7,945 kg)	35,000 lb (15,890 kg)
50932	2" x 30'	9,000 lb (4,086 kg)	18,000 lb (8,172 kg)



NEW!

Heavy Duty Recovery Straps

Heavy duty, 2 ply, weather resistant polyester, with reinforced loop ends.

- Load Capacity imprinted on webbing.

PART#	SIZE	MAX. VEHICLE WEIGHT	MAX. STRENGTH
50935	2" x 20'	18,000 lb (8,165 kg)	36,000 lb (16,329 kg)
50936	4" x 20'	27,000 lb (12,247 kg)	54,000 lb (24,493 kg)
50937	4" x 30'	27,000 lb (12,247 kg)	54,000 lb (24,493 kg)
50938	6" x 20'	40,000 lb (18,144 kg)	80,000 lb (36,287 kg)
50939	6" x 30'	40,000 lb (18,144 kg)	80,000 lb (36,287 kg)



NEW!

TOW ROPES

Tow Ropes

- **20 Feet** - White nylon with double end looped connection.
- Individually banded and shrink wrapped.



PART#	DIAMETER	MAX. VEHICLE WEIGHT	MAX. STRENGTH
12200	3/4"	7,100 lb	14,200 lb
12201	1"	12,500 lb	25,000 lb
12203	1-1/4"	18,750 lb	37,500 lb



Heavy Duty Tow Ropes

- **30 Feet** - Heavy duty tow ropes.
- Double ended loop connection.
- 8 white nylon braided strands.
- Individually packaged.

PART#	DIAMETER	MAX. VEHICLE WEIGHT	MAX. STRENGTH
12208	2-3/8"	56,000 lb	112,000 lb
12209	2-3/4"	75,000 lb	150,000 lb
12210	3-1/8"	97,500 lb	195,000 lb

DYNALINE CORNER PROTECTORS - PAGE 11



WINCH BARS

Winch Bar - Type A

PART#	DESCRIPTION
12245	Features knurled non-slip handle & carbon steel tip. 35" length.

Winch Bar - Type C

PART#	DESCRIPTION
12246	Features knurled handle for safe grip. Hardened, ribbed nose to add strength and prevent slippage. 37" length.

Cargo Winch - 3 Bar

Fits 4" winch straps.

PART#	DESCRIPTION	TYPE	W.L.L.
12284	Standard	Slide On	5,000 lb
12285	Low Profile	Weld-On	5,000 lb

Winch Truck Straps

Strong, weather-resistant nylon webbing with secure stitching and a variety of steel hooks. To be used with our Lashing and Cargo Winches.. Load Capacity imprinted on webbing.

PART#	SIZE	W.L.L.	MAX. LOAD	COLOR	HOOK TYPE
12240	2" x 30'	3,300 lb	10,000 lb	Yellow	Delta Ring
12242	4" x 30'	5,400 lb	16,200 lb	Yellow	Flat Hook
12243	4" x 30'	5,400 lb	16,200 lb	Yellow	D-Ring
12247	4" x 40'	5,400 lb	16,200 lb	Yellow	D-Ring
12248	4" x 40'	5,400 lb	16,200 lb	Yellow	Flat Hook
12249	4" x 40'	5,400 lb	16,200 lb	Yellow	J-Hook

Corner Protector

White plastic corner protector. Individually labeled and wrapped in sealed plastic bag. Accommodates up to 4" straps.

PART#	SIZE	COLOR	BOX QTY
12235	4"	White	90



NEW!



NEW!



NEW!



HAND WINCHES

Hand-cranked manual winches multiply your strength, allowing you to pull a relatively heavy load against gravity.

Larger models have a lower gear ratio to multiply your strength even more.

Winches also have a ratchet to hold the load at any point so it doesn't slide back, allowing a normal person to move a load, using a crank about a foot long and simple gearing.

*** Load Capacity is based on direct line pull on the first layer of line on the drum. Capacity decreases as line builds up on the drum.**

WARNING: WINCHES ARE NOT FOR THE MOVEMENT OF HUMANS OR FOR HOISTING LOADS OVER AREAS OCCUPIED BY HUMANS.



11344

Hand Winch - Dual Drive

Dual drive feature distributes the load evenly on the drum. To be used with steel cable. Winch drums are drilled for use with winch straps.

- Can be mounted vertically or horizontally.
- Solid carbon steel gears.
- Baked enamel painted finish.
- Supplied with grip handle & cable keeper.

PART#	LOAD CAPACITY*	GEAR RATIO
11344	3,200 lb	5.1:1 / 12:1
11345	3,700 lb	12.1:1



11300

Hand Winches - General Purpose

- Solid carbon steel gears.
- Embossed frame for added strength.
- Baked black enamel painted finish.
- Supplied with grip handle and cable keeper. Two-way Ratchet.

PART#	DESCRIPTION	LOAD CAPACITY*	GEAR RATIO	REPAIR KIT	HANDLE
11300	1-speed	600 lb	3:01	---	---
11301	1-speed	850 lb	3:01	11331	11321
11303	1-speed	1,200 lb	4:01	11333	11323
11304	1-speed	1,400 lb	4:01	11334	11324
11305	2-speed	2,000 lb	4:1 / 10:1	11335	11325
11306	2-speed & hand brake	2,500 lb	5:1 / 12:1	11336	11326



11308

Hand Winches - Auto Brake

Keeps loads automatically locked in position when handle is released. (Note: Minimum load required to activate brake mechanism).

- Baked black enamel painted finish.
- Supplied with grip handle & cable keeper.

PART#	LOAD CAPACITY*	GEAR RATIO	REPAIR KIT	HANDLE
11308	1,400 lb	4:01	11338	11328
11309	2,000 lb	12:1	---	---
11310	2,500 lb	12:1	---	---

Hand Winches - Worm Gear

Self-braking mechanism prevents loads from accidentally running free. The load remains fixed in position when handle is released.

- Baked enamel painted finish.
- Color box packaging.
- Supplied with cable keeper.

PART#	LOAD CAPACITY*	GEAR RATIO
11312	2,000 lb	41:1



Portable 12V Electric Winch

With 2000 lbs pulling capacity and 16' power cord. 6 Feet per minute loaded line speed. 1/4" Safety slip hook with latch. 8.9" x 4.4" x 1.25"

- Mounting plate.
- Manual hand crank.
- Wireless remote control.

PART#	CABLE DIAMETER	LENGTH	HOOK	MOUNTING PLATE
11350	3/16"	30"	1/4" Safety Slip Hook w/Latch	8.9" x 4.4" x 1.25"

ROLLING CAPACITY	BOAT CAPACITY	PULLING CAPACITY	LOADED LINE SPEED
6,000 lb	5,000 lb	2,000 lb	6'/Minute



NEW!

Approximate cable lengths based on popular cable sizes.

PART#	DESCRIPTION	1/8"	3/16"	1/4"	5/16"	3/8"
11300	Hand Winch, 600 lb	—	10M/32'	—	—	—
11301	Hand Winch, 800 lb	20M/65'	10M/32'	15M/49'	—	—
11303	Hand Winch, 1200 lb	25M/82'	20M/65'	20M/65'	—	—
11304	Hand Winch, 1400 lb	25M/82'	20M/65'	20M/65'	—	—
11305	Hand Winch, 2000 lb	—	20M/65'	20M/65'	15M/49'	10M/32'
11306	Hand Winch, 2500 lb	—	45M/150'	30M/98'	20M/65'	15M/49'
11308	Auto Brake Winch, 1400 lb	25M/82'	20M/65'	20M/65'	—	—
11309	Auto Brake Winch, 2000 lb	—	45M/150'	30M/98'	20M/65'	15M/49'
11310	Auto Brake Winch, 2500 lb	—	45M/150'	30M/98'	20M/65'	15M/49'
11312	Worm Gear Winch, 2000 lb	—	—	25M/65'	—	—
11344	Hand Winch Dual Drive, 3200 lb	—	45M/150'	30M/98'	20M/65'	15M/49'
11345	Hand Winch Dual Drive, 3200 lb	—	45M/150'	30M/98'	20M/65'	15M/49'



Replacement Cable Keeper

PART#	DESCRIPTION
11311	Holds steel cable onto winch drum.



11321

General Purpose Handles

PART#	DESCRIPTION	LOAD CAPACITY*	GEAR RATIO	FOR PART#
11321	1-speed	800 lb	3:01	11301
11323	1-speed	1,200 lb	4:01	11303
11324	1-speed	1,400 lb	4:01	11304
11325	2-speed	2,000 lb	4:1 / 10:1	11305
11326	2-speed	2,500 lb	5:1 / 12:1	11306
11328	Auto-Brake	1,400 lb	4:01	11308



General Purpose Repair Kits

PART#	DESCRIPTION	LOAD CAPACITY*	GEAR RATIO	FOR PART#
11331	1-speed	800 lb	3:01	11301
11333	1-speed	1,200 lb	4:01	11303
11334	1-speed	1,400 lb	4:01	11304
11335	2-speed	2,000 lb	4:1 / 10:1	11305
11336	2-speed	2,500 lb	5:1 / 12:1	11306

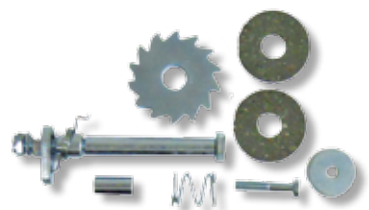

Auto Brake Repair Kit

PART#	DESCRIPTION
11338	Repair kit for Part# 11308



Anchor Points

Fits most full-size and compact light trucks with or without a bed liner.
 Chrome plated finish.

PART#	DESCRIPTION
11166	Fits most full-size and compact light trucks with or without a bed liner.

Anchor Rings

Zinc plated finish.

PART#	LENGTH	WIDTH	CAPACITY	PKG. QTY.
12250	1-1/2"	1"	900 lb	2
12253	2-3/8"	2-3/8"	11,000 lb	1

Recessed Anchor Rings

Surface mount. Zinc plated finish.

PART#	WIDTH	CAPACITY
12251	3-1/2"	1,200 lb

Heavy Duty Recessed Anchor Rings

Surface mount. Zinc plated finish.

PART#	WIDTH	CAPACITY
12252	4-7/16"	5,000 lb

Standard Recessed Anchor

Surface mount. Zinc plated finish.

PART#	WIDTH	CAPACITY
12254	2-3/4"	770 lb

Rotating Recessed D-Ring Anchor

Surface mount. Zinc plated finish.

PART#	WIDTH	CAPACITY
12256	6-1/4"	5,000 lb

Surface Mount Anchor

Surface mount. Zinc plated finish.

PART#	WIDTH	CAPACITY
12257	4-1/4"	1,200 lb

Pop-Up Anchor Point

Surface mount. Zinc plated finish.

PART#	DIAMETER	CAPACITY
12258	4-1/4"	1,200 lb

Standard Recessed Anchor

Surface mount. Chrome plated finish.

PART#	WIDTH	CAPACITY
12259	3-3/8" x 2-1/4"	5,000 lb





LOAD TIGHTENERS AND BINDERS

Ratchet Type Load Binders

Forged steel. Painted finish.

PART#	CHAIN	TAKE UP	W.L.L.	U.L.L.
66196	1/4" – 5/16"	5"	2,600 lb	7,800 lb
66197	5/16" – 3/8"	8"	5,400 lb	19,000 lb
66198	3/8" – 1/2"	8"	9,200 lb	33,000 lb
66199	1/2" – 5/8"	9"	13,000 lb	46,000 lb



Lever Type Load Binders

Forged steel. Painted finish.

PART#	CHAIN	TAKE UP	W.L.L.	U.L.L.
66203	1/4" – 5/16"	3.62	2,600 lb	7,800 lb
66204	5/16" – 3/8"	4.25	5,400 lb	19,000 lb
66202	3/8" – 1/2"	4.25	9,200 lb	33,000 lb



Load Tighteners

Painted finish.

PART#	CHAIN	TAKE UP	HANDLE	W.L.L.	U.L.L.
66200	3/16" – 1/4"	3-3/8"	Dixie Style	375 lb	1,500 lb
66201	3/16" – 1/4"	3-3/8"	Dominion Style	250 lb	1,000 lb



LOAD TIGHTENERS AND BINDERS

Load Binder Locks

PART#	DESCRIPTION
66205	Eliminates load binder release. Two width adjustments. Orange comes with tabquick pin.
66205-24	Display box. 24 pieces/pkg.
66461	Replacement Pin, 1/4" x 1-3/4".

Cable Type Load Binder Locks

Small diameter galvanized cable with aluminum stops and bracket. Lockable with padlock.

PART#	CABLE DIAMETER	LENGTH	PACKAGE QUANTITY
61205	1/8"	10"	400 pieces/carton
62205	3/16"	11"	300 pieces/carton

WARNING!

NEVER EXCEED WORKING LOAD LIMITS!

Always inspect load binders prior to use and replace when signs of wear occur.

- Do Not use handle extensions (cheater bars) for tightening.
- Load Binder must not bear against an object while under tension.
- Do Not operate load binders while you or anyone else is standing on the load.
- Always tighten handle in a downward manner, making sure to keep your body clear of moving handle, as it may whip.
- Always secure position of binder by wrapping the loose end of chain around handle.
- Do Not close your hand around handle.

FAILURE TO FOLLOW INSTRUCTIONS CAN RESULT IN SERIOUS INJURY!





DYNALINE

Better products for all.

Assortments

Casters

Dynakits

Dynatrays

Fasteners

Hose Reels

Keystock

Machinery Bushings

Material Handling

O-Ring Kits

Replacement Wheels



SHOP SUPPLIES

SHOP SUPPLIES

Dynatrays

Assortment Kits 1-8

Dynakits

Retail Assortment..... 9

Dynapaks 9

O-Rings Kits

SAE, Metric, Repair Kit 10-13

Key Stock

Keystock 13

Clevis Pins

Clevis Pins & Adjustable Clevis Pins..... 14

Machinery Bushings

10, 14, 18 Gauge 15

Springs

Bulk Springs 16-19

Extension, Draw Bar & Compression..... 20-22

Retainer Rings

External "E" Retainer 23

Internal Retainer 24

External Retainer..... 25

Hose Reels

Air, Industrial & Retractable 26

Jack Stands

Three Size of Jack Stands 26

Material Handling

Pulley Blocks Standard, Single, & Double .. 27

Snatch Block Heavy Duty with Hook
or Shackle 28

Beam Trolleys & Clams..... 28

Cable Pullers..... 28

Lever Hoists..... 29

Chain Hoists 29

Wheels

Pneumatic, Flat Free, Plastic & Bearings ... 30

Caster Wheels with Rigid, Swivel &
Swivel Brake 31

Pneumatic and Flat Free Caster Wheels 32

DYNATRAYS

Metric Grease Fittings - 110 Pieces

Part# 00108

9 popular sizes in a sturdy plastic case.
Dimensions: 8-1/2" L x 4-1/4" W x 1-1/4" D.
Contents:

PART#	DESCRIPTION	QTY.	PART#	DESCRIPTION	QTY.
11114	Straight, M6	60	11119	90°, M8	5
11115	45°, M6	5	11120	Straight, M10	10
11116	90°, M6	5	11126	45°, M10	5
11117	Straight, M8	10	11127	90°, M10	5
11118	45°, M8	5			



Grease Fittings Assortments - 70 Pieces

Part# 10109

9 popular sizes of S.A.E. and Metric grease fittings: 1/8" NPT, 1/4"-28, M6, M8 and M10, both in straight, 45° and 90° types.
Dimensions: 8-1/2" L x 4-1/4" W x 1-1/4" D
Contents:

PART#	DESCRIPTION	QTY.	PART#	DESCRIPTION	QTY.
11100	Straight, 1/8" NPT	10	11109	90°, 1/4"-28	5
11102	45°, 1/8" NPT	5	11114	Straight, M6	10
11104	90°, 1/8" NPT	5	11117	Straight, M8	5
11105	Straight, 1/4"-28	20	11120	Straight, M10	5
11107	45°, 1/4"-28	5			



S.A.E. Grease Fittings Assortments - 100 Pieces

Part# 00112

7 popular sizes in a sturdy plastic case.
Dimensions: 8-1/2" L x 4-1/4" W x 1-1/4" D.
Contents:

PART#	DESCRIPTION	QTY.	PART#	DESCRIPTION	QTY.
11100	Straight, 1/8" NPT	25	11107	45°, 1/4"-28	5
11102	45°, 1/8" NPT	5	11109	90°, 1/4"-28	5
11104	90°, 1/8" NPT	5			
11105	Straight, 1/4"-28	50			



*NPT - National Pipe Thread Taper

Sizes are approximate, specifications subject to change without notice.



Hair Pin Assortments - 83 Pieces

Part# 00113

6 popular sizes in a sturdy plastic case.
 Dimensions: 10-1/2" L x 4-3/4" W x 1-3/4" D.
 Contents:

PART#	DESCRIPTION	QTY.	PART#	DESCRIPTION	QTY.
66301	3/32" x 1-11/16"	25	66305	5/32" x 3-5/16"	15
66302	3/16" x 3-1/4"	10	66306	1/8" x 2-5/8"	20
66304	3/16" x 3-1/4" Long	8	66308	1/4" x 4-1/4"	5



Mini Plug-In Fuses Assortments - 101 Pieces

Part# 00119

The most popular sizes in a sturdy plastic case. Includes a fuse puller.
 Dimensions: 6" L x 3-1/2" W x 1-1/4" D.
 Contents:

DESCRIPTION	QTY.
2A, 3A, 5A, 7.5A	5 ea.
10A, 20A, 25A, 30A	15 ea.
15A	20
Fuse Puller	1



Standard Plug-In Fuses Assortments - 101 Pieces

Part# 00121

The most popular sizes in a sturdy plastic case. Includes a Fuse Puller.
 Dimensions: 6" L x 3-1/2" W x 1-1/4" H.
 Contents:

DESCRIPTION	QTY.
3A, 5A, 7.5A, 25A	10 ea.
10A, 15A, 20A, 30A	15 ea.
Fuse Puller	1
Fuse Puller	1



Socket Set Screws Assortments - 200 Pieces

Part# 10119

12 most popular sizes of socket set screws ranging in size from 5/32" to 1/4".
 Dimensions: 8-1/2" L x 4-1/4" W x 1-1/4" D.
 Contents:

DESCRIPTION	THREAD	QTY.	DESCRIPTION	THREAD	QTY.	DESCRIPTION	THREAD	QTY.
5/32" x 3/16"	32	10	1/4" x 1/4"	20	30	3/16" x 1/4"	24	10
5/16" x 3/8"	18	30	3/8" x 1/2"	16	10	1/4" x 1/4"	28 (Fine)	20
3/8" x 3/8"	16	10	3/8" x 3/8"	24 (Fine)	10	1/4" x 3/8"	20	20
1/8" x 3/16"	40	10	5/16" x 3/8"	24 (Fine)	20			
			5/16" x 1/2"	18	20			

Sizes are approximate, specifications subject to change without notice.

Automotive Electric Repair Kit- 285 Pieces

Part# 00133

All the products needed for automotive electrical repairs, conveniently packed in a high impact plastic carry case. Dimensions: 10-1/4" L x 6-3/4" W x 3" H. Contents:

DESCRIPTION	SPECIFICATIONS	QTY.
Crimping Tool	8-3/4" length	1
Voltage Tester	6V - 12V - 24V, DC	1
Electrical Tape Roll	10m, UL/CSA approved	1
Primary Wire Roll	1.5m	1
Screwdrivers	Philips, Flat	2
Rubber Grommets	—	6
Cable Ties	30 of 4", 10 of 6", 10 of 7-1/2"	50
Test Leads	32"	2
Blade Fuses	1 each of 10A, 15A, 20A, 25A, 30A	5
Glass Fuses	1 each of 5A, 15A, 20A; 2 of 10A	5
Cable Clamps	10 of 1/8", 3 of 1/4"	13
Heat Shrink Tubes	6 of 3/16" x 1-1/2", 4 of 1/8" x 1/2"	10
Insulated Terminals	64 Round Rings, 40 Spades, 40 Butts, 27 Wire Connectors, 16 Lugs (M & F)	187
Carrying Case	High impact plastic, translucent lids	1



Spring Assortments - 200 Pieces

Part# 10100

20 popular sizes of Compression and Expansion Springs. Dimensions: 8-1/2" L x 4-1/4" W x 1-1/4" D. Contents:

DESCRIPTION	QTY.	DESCRIPTION	QTY.
Compression, 5/32" x 1/2"	10	Expansion, 3/16" x 1-3/4"	10
Compression, 5/32" x 3/4"	10	Expansion, 5/32" x 1-1/2"	10
Compression, 3/16" x 3/4"	10	Expansion, 5/32" x 2"	10
Compression, 7/32" x 11/16"	10	Expansion, 5/32" x 3-1/2"	10
Compression, 7/32" x 1-1/2"	10	Expansion, 13/64" x 13/16"	10
Compression, 1/4" x 13/32"	10	Expansion, 1/4" x 7/8"	10
Compression, 5/16" x 1-3/4"	10	Expansion, 5/16" x 1-1/8"	10
Compression, 23/64" x 1-3/8"	10	Expansion, 7/32" x 1"	10
Compression, 3/8" x 5/8"	10	Expansion, 11/32" x 1-27/32"	10
Expansion, 3/16" x 1-1/4"	10	Expansion, 11/32" x 1-7/16"	10



Sizes are approximate, specifications subject to change without notice.



O-Ring Assortments - 270 Pieces

Part# 10101

18 popular sizes of green HNBR O-Rings for air conditioning applications.
 Dimensions: 8-1/2" L x 4-1/4" W x 1-1/4" D.
 Contents:

DESCRIPTION	IND#	QTY.	DESCRIPTION	IND#	QTY.
7/32" I.D. x 1/16" Thick	9	20	9/16" I.D. x 3/32" Thick	113	10
1/4" I.D. x 1/16" Thick	10	20	11/16" I.D. x 1/16" Thick	17	10
9/32" I.D. x 5/64" Thick	--	20	11/16" I.D. x 1/8" Thick	--	10
5/16" I.D. x 1/16" Thick	11	20	8 mm I.D. x 2 mm Thick	54504	20
5/16" I.D. x 5/64" Thick	--	20	10 mm I.D. x 2 mm Thick	54505	10
11/32" I.D. x 5/64" Thick	--	20	11 mm I.D. x 2 mm Thick	--	15
7/16" I.D. x 1/16" Thick	13	15	12 mm I.D. x 2 mm Thick	--	15
7/16" I.D. x 3/32" Thick	111	15	15 mm I.D. x 2 mm Thick	--	10
9/16" I.D. x 1/16" Thick	15	10	17 mm I.D. x 2 mm Thick	--	10

***HNBR - Hydrogenated Nitrile Butadiene Rubber**



Cotter Pin Assortments - 560 Pieces

Part# 10102

The 6 most popular sizes of Cotter Pins, from 1/16" to 5/32" in diameter.
 Dimensions: 8-1/2" L x 4-1/4" W x 1-1/4" D.
 Contents:

DESCRIPTION	QTY.	DESCRIPTION	QTY.
1/16" x 1" long	150	1/8" x 1-1/4" long	80
3/32" x 1" long	150	1/8" x 2" long	50
3/32" x 1-1/2" long	100	5/32" x 2-1/2" long	30



Cotter Pin (Large) Assortments - 150 Pieces

Part# 10103

The 6 most popular sizes of Large Cotter Pins, from 1/8" to 5/16" in diameter.
 Dimensions: 8-1/2" L x 4-1/4" W x 1-1/4" D.
 Contents:

DESCRIPTION	QTY.	DESCRIPTION	QTY.
1/8" x 2" long	50	1/4" x 2" long	20
5/32" x 2-1/2" long	30	1/4" x 3" long	20
3/16" x 3" long	20	5/16" x 2-1/2" long	10

Sizes are approximate, specifications subject to change without notice.

Hair Pin Assortments - 150 Pieces

Part# 10105

The 6 most popular sizes of Hair Pins, from 3/32" to 5/32" in diameter.
 Dimensions: 8-1/2" L x 4-1/4" W x 1-1/4" D.
 Contents:

DESCRIPTION	QTY.	DESCRIPTION	QTY.
3/32" x 1-3/16"	42	7/64" x 1-5/8"	25
5/64" x 1-5/16"	30	9/64" x 1-3/4"	20
5/64" x 1-9/16"	25	5/32" x 2-15/16"	8



Snap Ring Assortments - 300 Pieces

Part# 10106

18 popular sizes of Snap Rings, from 1/8" to 1-1/4" in diameter.
 Dimensions: 8-1/2" L x 4-1/4" W x 1-1/4" D.
 Contents:

DESCRIPTION	QTY.	DESCRIPTION	QTY.
5/32"	10	9/16"	15
3/16"	15	5/8"	20
1/8"	20	3/4"	25
5/16"	15	13/16"	15
1/4"	25	7/8"	20
3/8"	20	1"	15
7/16"	15	1-1/16"	15
15/32"	15	1-1/8"	10
1/2"	25	1-1/4"	5



Wire Terminals Assortments - 160 Pieces

Part# 10107

The 8 most popular types of wire terminals: Ring, Male, Female, Splice, Spade, Butt, Bullet Male and Bullet Female.
 Dimensions: 8-1/2" L x 4-1/4" W x 1-1/4" D.
 Contents:

DESCRIPTION	QTY.
Ring Terminals	50
Male Connectors	5
Female Disconnectors	5
Quick Splices	8
Spade Terminals	10
Butt Connectors	42
Bullet Male Connector	20
Bullet Female Disconnectors	20



Sizes are approximate, specifications subject to change without notice.



Grommet Assortments - 125 Pieces

Part# 10108

18 popular sizes of solid & hollow grommets, from 1/8" to 1" in diameter.
Dimensions: 8-1/2" L x 4-1/4" W x 1-1/4" D.
Contents:

DESCRIPTION	QTY.	DESCRIPTION	QTY.
1/8" x 9/32"	15	1/2" x 21/32"	4
3/16" x 5/16"	10	5/8" x 1"	3
1/4" x 1/2"	7	3/4" x 15/16"	2
5/16" x 17/32"	3	Solid, 5/16"	20
3/8" x 1/2"	6	Solid, 3/8"	20
3/8" x 9/16"	5	Solid, 1/2"	10
3/8" x 3/4"	3	Solid, 5/8"	5
7/16" x 3/4"	3	Solid, 3/4"	4
7/8"	3	Solid, 1"	2



Auto Fuses Assortment s- 80 Pieces

Part# 10110

Standard and Mini Fuses, from 5 to 30A.
Dimensions 8-1/2" L x 4-1/4" W x 1-1/4" D.
Contents:

DESCRIPTION	QTY.	DESCRIPTION	QTY.
Standard, 5A, Pink	5	Mini, 5A, Pink	5
Standard, 10A, Red	10	Mini, 10A, Red	5
Standard, 15A, Blue	5	Mini, 15A, Blue	5
Standard, 20A, Yellow	10	Mini, 20A, Yellow	10
Standard, 25A, Clear	5	Mini, 25A, Clear	5
Standard, 30A, Green	10	Mini, 30A, Green	5



Wire Connector Assortments - 158 Pieces

Part# 10111

5 popular sizes of Wire Connectors from 22 to 10 Gauge.
Dimensions: 8-1/2" L x 4-1/4" W x 1-1/4" D.
Contents:

DESCRIPTION	QTY.
22 Gauge, Grey	40
22 Gauge, Blue	40
16 Gauge, Orange	50
14 Gauge, Yellow	18
10 Gauge, Red	10

Sizes are approximate, specifications subject to change without notice.

Allen Cap Screw Assortments - 106 Pieces

Part# 10112

9 popular sizes of Allen Cap Screws.
Dimensions: 8-1/2" L x 4-1/4" W x 1-1/4" D.
Contents:

DESCRIPTION	QTY.	DESCRIPTION	QTY.
#8 - 32 x 1/12"	25	5/16" - 18 x 1"	5
#10 - 24 x 1/2"	25	5/16" - 18 x 1-1/2"	5
#10 - 24 x 1"	20	3/8" - 16 x 1"	3
1/4" - 20 x 1/2"	10	3/8" - 16 x 1-1/2"	3
1/4" - 20 x 1"	10		



Woodruff Key Assortments - 80 Pieces

Part# 10113

The 8 most popular sizes of Woodruff Keys.
Dimensions: 8-1/2" L x 4-1/4" W x 1-1/4" D.
Contents:

DESCRIPTION	QTY.	DESCRIPTION	QTY.
5/32" x 9/32" x 3/4"	10	1/8" x 1/4" x 5/8"	10
3/16" x 9/32" x 3/4"	10	5/32" x 1/4" x 5/8"	10
1/8" x 3/16" x 1/2"	10	3/16" x 11/32" x 7/8"	10
5/32" x 3/16" x 1/2"	10	1/4" x 11/32" x 7/8"	10



Copper Washer Assortments - 110 Pieces

Part# 10114

6 popular sizes of Copper Washers, from 1/4" to 5/8" in diameter.
Dimensions: 8-1/2" L x 4-1/4" W x 1-1/4" D.
Contents:

DESCRIPTION	QTY.	DESCRIPTION	QTY.
1/4"	30	7/16"	15
5/16"	25	1/2"	10
3/8"	20	5/8"	10



"E" Retainer Ring Assortments - 300 Pieces

Part# 10104

9 popular sizes of External "E" Retainer Rings from 1/16" to 7/8" in diameter.
Dimensions: 8-1/2" L x 4-1/4" W x 1-1/4" D.
Contents:

DESCRIPTION	QTY.	DESCRIPTION	QTY.
1/16"	30	1/4"	50
1/8"	30	3/8"	50
3/16"	40		



Sizes are approximate, specifications subject to change without notice.



Rubber Sealing Washer Assortments - 141 Pieces

Part# 10115

18 popular sizes of Rubber Sealing Washers.
 Dimensions: 8-1/2" L x 4-1/4" W x 1-1/4" D.
 Contents:

DESCRIPTION	QTY.	DESCRIPTION	QTY.	DESCRIPTION	QTY.
Rubber		Fiber		Kingerit	
1/2" x 16	10	21 x 17	10	1-1/2"-27 x 38	3
3/4" x 15 x 24	10	1/2"	10	1/2"-12 x 18	10
1/2" x 10	5	3/8" x 8	10	1-1/4"-30 x 39	3
3/8" x 8	5	1"	5	3/4"-16 x 24	10
3/4"-11 x 24 x 2	10	3/4"	10		
3/8" x 10	5	3/8"	10		
1/2" x 17	10				
1/2"-9 x 19	5				



Rivet Assortments - 500 Pieces

Part# 10117

125 pieces each of 1/8" Rivets in 4 popular lengths from 1/4" to 5/8".
 Dimensions: 8-1/2" L x 4-1/4" W x 1-1/4" D.
 Contents:

DESCRIPTION	QTY.	DESCRIPTION	QTY.
1/8" x 1/4"	125	1/8" x 3/8"	125
1/8" x 5/16"	125	1/8" x 5/8"	125



Fuse Assortments - 92 Pieces

Part# 10118

15 Standard Fuses in 6 amperages each, plus a fuse puller and a 6-24V tester. Dimensions: 8-1/2" L x 4-1/4" W x 1-1/4" D.
 Contents:

DESCRIPTION	QTY.	DESCRIPTION	QTY.
Standard, 5A, Pink	15	Standard, 25A, Clear	15
Standard, 10A, Red	15	Standard, 30A, Green	15
Standard, 15A, Blue	15	Fuse Puller	1
Standard, 20A, Yellow	15	6-24V Tester	1

Sizes are approximate, specifications subject to change without notice.

DYNAKITS

Retail assortments of our most popular items with hanging tab and positive locking closures. Made of durable, transparent polypropylene. Dimensions 4-1/4" L x 2-7/8" W x 1-7/16" D.

PART#	CONTENTS	QTY.
00140	Standard Plug-In Fuses	50 pcs. / 5 sizes
00141	Mini Plug-In Fuses	50 pcs. / 5 sizes
00160	Cotter Pins (Small)	215 pcs. / 8 sizes
00161	Cotter Pins (Large)	40 pcs. / 12 sizes
00163	S.A.E. Grease Fittings	40 pcs. / 6 sizes
00164	Hair Pins	28 pcs. / 8 sizes
00173	Spring Pins	62 pcs. / 13 sizes
00174	Woodruff Keys	40 pcs. / 12 sizes
00175	"E" Retainer Rings	70 pcs. / 7 sizes
00176	Internal Retainer Rings	55 pcs. / 11 sizes
00177	External Retainer Rings	70 pcs. / 14 sizes
00178	Clevis Pins	23 pcs. / 14 sizes
00179	S.A.E. O-Rings	95 pcs. / 15 sizes
00180	Keystock	30 pcs. / 5 sizes
00181	Metric Grease Fittings	50 pcs. / 7 sizes
00182	Drive-In Grease Fittings	50 pcs. / 4 sizes
00189	Universal Clevis Pins	11 pcs. / 9 sizes



DYNAPAKS

Grease Fitting Dynapak Assortments
The most popular sizes and types, in a convenient retail package.
Dimensions: 3-3/8" L x 1-3/4" W x 7/8" D.

PART#	CONTENTS	QTY.
11135A	S.A.E. Grease Fittings	10 pcs. / 5 sizes
11136A	Metric Grease Fittings	10 pcs. / 6 sizes



Sizes are approximate, specifications subject to change without notice.

O-RING KITS

N70 S.A.E. O-Ring Kit - 407 Pieces



Part# 00150

32 sizes of **Buna-N 70** durometer O-Rings in a plastic box with thickness gauge.
Dimensions: 9-3/4" L x 6-1/2" W x 1-3/4" H.
Contents:

PART#	IND#	QTY.	LOC.	PART#	IND#	QTY.	LOC.
54006	6	20	R-01	54116	116	13	R-13
54008	8	20	R-02	54117	117	13	R-14
54010	10	20	R-03	54118	118	13	R-15
54011	11	20	R-04	54210	210	10	R-16
54012	12	20	R-05	54211	211	10	R-17
				54212	212	10	R-18
				54213	213	10	R-19
				54214	214	10	R-20
				54215	215	10	R-21
				54216	216	10	R-22
				54217	217	10	R-23
				54218	218	10	R-24
				54219	219	10	R-25
				54220	220	10	R-26
				54221	221	10	R-27
				54222	222	10	R-28
				54223	223	10	R-29
				54224	224	10	R-30
				54225	225	10	R-31
				54226	226	10	R-32

N70 Metric O-Ring Kit - 419 Pieces



Part# 00151

32 sizes of **Buna-N 70** durometer Metric O-Rings in a lockable plastic box.
Dimensions: 9-3/4" L x 6-1/2" W x 1-3/4" H".
Contents:

PART#	I.D. (MM)	QTY.	LOC.	PART#	I.D. (MM)	QTY.	LOC.	PART#	I.D. (MM)	QTY.	LOC.
54501	3	20	R-01	54506	13	23	R-06	54515	22	13	R-15
54502	4.4	20	R-02	54507	10	14	R-07	54516	18	10	R-16
54503	5	18	R-03	54508	11	13	R-08	54517	20	10	R-17
54504	7	23	R-04	54509	13	14	R-09	54518	22	10	R-18
54505	10	23	R-05	54510	14	13	R-10	54519	23.5	10	R-19
				54511	16	14	R-11	54520	25	10	R-20
				54512	18	14	R-12	54521	26.5	10	R-21
				54513	19	13	R-13	54522	28	10	R-22
				54514	21	14	R-14	54523	30	10	R-23
								54524	31	10	R-24
								54525	33	10	R-25
								54526	34.5	10	R-26
								54527	36	10	R-27
								54528	38	10	R-28
								54529	41	10	R-29
								54530	44	10	R-30
								54531	47	10	R-31
								54532	50	10	R-32

High Pressure O-Ring Kit - 212 Pieces



Part# 00152

20 sizes of **Buna-N 90** durometer O-Rings (Nitrile Durometer A) in a plastic box. Dimensions: 9" L x 6-1/2" W x 1-3/4" H".
Contents:

PART#	I.D. (MM)	QTY.	LOC.	PART#	I.D. (MM)	QTY.	LOC.	PART#	I.D. (MM)	QTY.	LOC.
54901	0.185	10	901	54903	0.301	10	903	54910	0.755	12	910
54902	0.239	10	902	54904	0.351	10	904	54911	0.863	10	911
				54905	0.414	12	905	54912	0.924	10	912
				54906	0.468	12	906	54913	0.986	10	913
				54907	0.530	12	907	54914	1.047	10	914
				54908	0.644	12	908	54916	1.171	10	916
				54909	0.706	12	909	54918	1.355	10	918
								54920	1.475	10	920
								54924	1.720	10	924
								54928	2.090	10	928
								54932	2.337	10	932

LOC. = LOCATION

High Temp V75 O-Ring Kit - 382 Pieces

Part# 00153

30 sizes of Viton 75 O-Rings, High Temp: -25°C to 200°C. In a plastic box with thickness gauge. Dimensions: 9-3/4" L x 6-1/2" W x 1-3/4" H.

Contents:

O.D.	I.D.	QTY.	LOCATION	O.D.	I.D.	QTY.	LOCATION
1/4"	1/8"	20	6	1-1/8"	7/8"	10	212
9/32"	5/32"	20	7	1-3/16"	15/16"	10	213
5/16"	3/16"	20	8	1-1/4"	1"	10	214
11/32"	7/32"	20	9	15/16"	11/16"	10	215
3/8"	1/4"	20	10	3/4"	9/16"	13	113
7/16"	5/16"	20	11	3/16"	5/8"	13	114
1/2"	3/8"	20	12	7/8"	11/16"	13	115
9/16"	3/8"	13	110	15/16"	3/4"	13	116
5/8"	7/16"	13	111	1"	3/4"	10	210
11/16"	1/2"	13	112	1-1/16"	13/16"	10	211
3/4"	9/16"	13	113	1-1/8"	7/8"	10	212
3/16"	5/8"	13	114	1-3/16"	15/16"	10	213
7/8"	11/16"	13	115	1-1/4"	1"	10	214
15/16"	3/4"	13	116	15/16"	11/16"	10	215
1"	3/4"	10	210	1-3/8"	1-1/8"	10	216
1-1/16"	13/16"	10	211	1-9/16"	1-3/16"	10	217



O.D.	I.D.	QTY.	LOCATION
1-1/2"	1-1/4"	10	218
1-3/16"	15/16"	10	219
1-5/8"	1-3/8"	10	220
1-1/2"	1-1/16"	10	221
1-3/4"	1-1/2"	10	222
1-7/8"	1-1/2"	7	325
2"	1-5/8"	7	326
2-1/8"	1-3/4"	7	327

N90 S.A.E. O-Ring Kit - 382 Pieces

Part# 00154

30 sizes of Buna-N 90 durometer O-Rings in a plastic box with thickness gauge. Dimensions: 9-3/4" L x 6-1/2" W x 1-3/4" H.

Contents:

O.D.	I.D.	QTY.	LOCATION	O.D.	I.D.	QTY.	LOCATION
1/4"	1/8"	20	6	1-1/16"	13/16"	10	211
9/32"	5/32"	20	7	1-1/8"	7/8"	10	212
5/16"	3/16"	20	8	1-3/16"	15/16"	10	213
11/32"	7/32"	20	9	1-1/4"	1"	10	214
3/8"	1/4"	20	10	15/16"	11/16"	10	215
7/16"	5/16"	20	11	1-3/8"	1-1/8"	10	216
1/2"	3/8"	20	12	1-9/16"	1-3/16"	10	217
9/16"	3/8"	13	110	1-1/2"	1-1/4"	10	218
5/8"	7/16"	13	111	1-3/16"	15/16"	10	219
11/16"	1/2"	13	112	1-5/8"	1-3/8"	10	220
3/4"	9/16"	13	113	1-1/2"	1-1/16"	10	221
3/16"	5/8"	13	114	1-3/4"	1-1/2"	10	222
7/8"	11/16"	13	115	1-7/8"	1-1/2"	7	325
15/16"	3/4"	13	116	2"	1-5/8"	7	326
1"	3/4"	10	210	2-1/8"	1-3/4"	7	327



Buna-N Rubber is also referred to as Nitrile Rubber. Nitrile rubber is a copolymer of butadiene and acrylonitrile. In addition to its excellent elastomeric properties, it is resistant to oil, caustics, and aliphatic hydrocarbons. Nitrile is not suitable for solvents and chlorinated hydrocarbons. Its maximum temperature limit is 212° F.

Viton is a brand of synthetic rubber and fluoropolymer elastomer commonly used in O-rings and other molded or extruded goods. Viton fluoroelastomers are categorized under the ASTM D1418 and ISO 1629 designation of FKM. This class of elastomers is a family comprising copolymers of hexafluoropropylene (HFP) and vinylidene fluoride (VDF or VF2), terpolymers of tetrafluoroethylene (TFE), vinylidene fluoride (VDF) and hexafluoropropylene (HFP) as well as perfluoromethylvinylether (PMVE) containing specialties. The fluorine content of the most common Viton grades varies between 66 and 70%.



N70 O-Ring Splicing Kit - 5 Pieces

Part# 00155

5 sizes of Buna-N 70 durometer O-Rings. Cords and all the tools required to produce a perfect O-Ring, in a lockable plastic box.

Dimensions: 10-1/2" L x 4-3/4" W x 1-3/4" H.

Contents:

DESCRIPTION	LENGTH	DESCRIPTION	QTY.
1/16" O-Ring Cord	3 ft.	Splicing/ Cutting Tool	1
3/32" O-Ring Cord	3 ft.	Cyanocrylate Super Glue, 2g	1
1/8" O-Ring Cord	3 ft.	Razor blade	1
7/32" O-Ring Cord	3 ft.		
9/32" O-Ring Cord	3 ft.		



Japanese Metric O-Ring Kit - 380 Pieces

Part# 00156

36 sizes of Buna-N 70 durometer JIS-2401* Metric O-Rings in a plastic box.

Dimensions: 7-3/4" L x 5-1/2" W x 1-3/4" H.

Contents:

IND#	SIZE	QTY.	IND#	SIZE	QTY.	IND#	SIZE	QTY.
P3	2.8x1.9	25	P12.5	12.3x2.4	12	P24	23.7x3.5	7
P4	3.8x1.9	20	P14	13.8x2.4	12	V24	23.5x4	6
P5	4.8x1.9	20	P15	14.8x2.4	12	P25	24.7x3.5	7
P6	5.8x1.9	20	P16	15.8x2.4	12	P25.5	25.2x3.5	7
P7	6.8x1.9	15	V15	14.5x4	4	P26	25.7x3.5	7
P8	7.8x1.9	15	P18	17.8x2.4	8	P28	27.7x3.5	7
P9	8.8x1.9	15	P20	19.8x2.4	8	G30	29.4x3.1	7
P10	9.8x1.9	15	P21	20.8x2.4	8	P29	28.7x3.5	6
P10A	9.8x2.4	15	P22	21.8x2.4	8	P29.5	29.2x3.5	6
P11	10.8x2.4	15	P22A	21.7x3.5	5	P30	29.7x3.5	6
P11.2	11x2.4	15	P22.4	22.1x3.5	5	P31	30.7x3.5	6
P12	11.8x2.4	12	G25	24.4x3.1	6	P31.5	31.2x3.5	6

* Japanese Industrial Standard (JIS) 2401 "O-rings." The classification system recommended by this standard is twofold, by material and by size and use.



O-Ring Flange Kit - 150 Pieces

Part# 00157

8 sizes of Buna-N 90 durometer O-Ring Seals in a transparent plastic box with dividers and hanging tab. Dimensions: 9" L x 4-3/4" W x 1" H.

Contents:

IND#	QTY.	IND#	QTY.	IND#	QTY.	IND#	QTY.
011	25	014	25	018	20	025	10
012	25	016	20	021	15	029	10

Sizes are approximate, specifications subject to change without notice.

N70 Metric O-Ring Kit - 425 Pieces

Part# 00158

30 sizes of Buna-N 70 durometer Metric O-Rings in a plastic box with dividers and transparent lid. Dimensions: 11-1/4" L x 8-3/4" W x 1-3/4" H. Contents:

SIZE	QTY.	SIZE	QTY.	SIZE	QTY.	SIZE	QTY.
3.0 x 1.5	20	12.0 x 2.0	20	7.0 x 2.5	15	18.0 x 3.0	10
5.0 x 1.5	20	14.0 x 2.0	20	10.0 x 2.5	15	20.2 x 3.0	5
7.0 x 1.5	20	6.3 x 2.4	15	12.0 x 2.5	15	22.2 x 3.0	5
9.0 x 1.5	20	8.3 x 2.4	15	15.0 x 2.5	15	24.2 x 3.0	5
11.0 x 1.5	20	11.3 x 2.4	15	10.0 x 3.0	10	26.2 x 3.0	5
6.0 x 2.0	20	13.3 x 2.4	15	12.0 x 3.0	10	30.2 x 3.0	5
8.0 x 2.0	20	17.7 x 2.4	15	14.0 x 3.0	10		
10.0 x 2.0	20	5.0 x 2.5	15	16.0 x 3.0	10		



KEYSTOCK

Supplied in 12" lengths only. Cold-drawn C-1018 steel. Zinc plated finish. Rockwell "C" hardness: 60.

Square Keystock

Thickness tolerance ± 0.1 mm; length tolerance ± 0.3 mm.

PART#	WIDTH	HEIGHT	QTY.	PART#	WIDTH	HEIGHT	QTY.
22750	1/8"	1/8"	Pkg. of 5	22756	1/2"	1/2"	Pkg. of 5
22751	3/16"	3/16"	Pkg. of 5	22758	5/8"	5/8"	Pkg. of 2
22752	1/4"	1/4"	Pkg. of 5	22760	3/4"	3/4"	Pkg. of 2
22753	5/16"	5/16"	Pkg. of 5	22761	7/8"	7/8"	Pkg. of 1
22754	3/8"	3/8"	Pkg. of 5	22763	1"	1"	Pkg. of 1
22755	7/16"	7/16"	Pkg. of 5				



Rectangular Keystock

Thickness tolerance ± 0.1 mm; length tolerance ± 0.1 mm.

PART#	WIDTH	HEIGHT	QTY.	PART#	WIDTH	HEIGHT	QTY.
22782	1/8"	1/8"	Pkg. of 5	22791	3/8"	7/16"	Pkg. of 5
22785	3/16"	3/16"	Pkg. of 5	22792	3/8"	1/2"	Pkg. of 5
22786	1/4"	1/4"	Pkg. of 5	22795	7/16"	1/2"	Pkg. of 5
22789	5/16"	5/16"	Pkg. of 5	22796	1/2"	5/8"	Pkg. of 2



Step Keystock

Thickness tolerance ± 0.1 mm; length tolerance ± 0.1 mm.

PART#	A	B	C	D	QTY.	PART#	A	B	C	D	QTY.
22821	3/16"	3/32"	1/4"	3/32"	Pkg. of 2	22825	3/8"	3/16"	7/16"	5/32"	Pkg. of 2
22822	1/4"	1/8"	5/16"	1/8"	Pkg. of 2	22826	3/8"	3/16"	1/2"	3/16"	Pkg. of 2
22823	1/4"	1/8"	3/8"	3/16"	Pkg. of 2	22827	7/16"	5/32"	1/2"	1/4"	Pkg. of 2
22824	5/16"	5/32"	3/8"	3/16"	Pkg. of 2	22828	1/2"	1/4"	5/8"	1/4"	Pkg. of 2

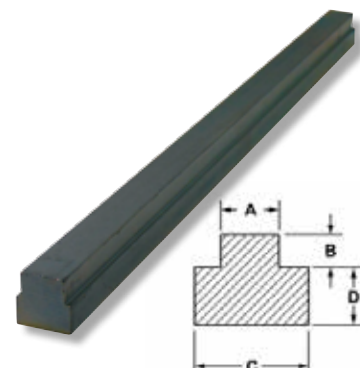



CLEVIS PINS

Yellow zinc dichromate finish. Hole is 1/4" from end of pin.
Package quantity 10 pcs. Made of C1020 steel*.

PART#	PIN DIAMETER	A	B	PART#	PIN DIAMETER	A	B
22500	1/4"	1"	1-1/4"	22521	3/8"	1-3/4"	2"
22501	1/4"	1-1/4"	1-1/2"	22522	3/8"	2"	2-1/4"
22502	1/4"	1-1/2"	1-3/4"	22523	3/8"	2-1/4"	2-1/2"
22503	1/4"	1-3/4"	2"	22528	7/16"	1-1/4"	1-1/2"
22504	1/4"	2"	2-1/4"	22529	7/16"	1-1/2"	1-3/4"
22505	1/4"	2-1/4"	2-1/2"	22530	7/16"	1-3/4"	2"
22509	5/16"	1"	1-1/4"	22531	7/16"	2"	2-1/4"
22510	5/16"	1-1/4"	1-1/2"	22532	7/16"	2-1/4"	2-1/2"
22511	5/16"	1-1/2"	1-3/4"	22536	1/2"	1"	1-1/4"
22512	5/16"	1-3/4"	2"	22537	1/2"	1-1/4"	1-1/2"
22513	5/16"	2"	2-1/4"	22538	1/2"	1-1/2"	1-3/4"
22514	5/16"	2-1/4"	2-1/2"	22539	1/2"	1-3/4"	2"
22518	3/8"	1"	1-1/4"	22540	1/2"	2"	2-1/4"
22519	3/8"	1-1/4"	1-1/2"	22541	1/2"	2-1/4"	2-1/2"
22520	3/8"	1-1/2"	1-3/4"	22542	1-1/2"	6"	7" (hole is 1/2")



CLEVIS PIN DYNAPAKS

PART#	CONTENTS	QTY.	PART#	CONTENTS	QTY.
92500	22500	Pkg. of 5	92518	22518	Pkg. of 3
92502	22502	Pkg. of 5	92520	22520	Pkg. of 3
92504	22504	Pkg. of 5	92522	22522	Pkg. of 3
92509	22509	Pkg. of 5	92529	22529	Pkg. of 2
92511	22511	Pkg. of 5	92538	22538	Pkg. of 2
92513	22513	Pkg. of 5	92540	22540	Pkg. of 2



ADJUSTABLE CLEVIS PINS

A quick replacement pin, the universal clevis pin features a series of holes making it adaptable to varying lengths. Use the diameter that fits your application and cut off the excess length. Easily replaces bolts, cotter pins or rivets on all types of equipment. Yellow zinc dichromate finish. First pin hole is 1/4" from the end of the pin.

PART#	PIN DIAMETER	OVERALL LENGTH	QTY.	PART#	PIN DIAMETER	OVERALL LENGTH	QTY.
22545	1/4"	2"	Pkg. of 5	22551	1/2"	2-1/2"	Pkg. of 5
22546	5/16"	2"	Pkg. of 5	22552	7/16"	3"	Pkg. of 5
22547	3/8"	2"	Pkg. of 5	22553	1/2"	3"	Pkg. of 5
22548	7/16"	2"	Pkg. of 5	22554	5/8"	3"	Pkg. of 5
22549	1/2"	2"	Pkg. of 5	22555	3/4"	3"	Pkg. of 5
22550	7/16"	2-1/2"	Pkg. of 5				

* 1020 is a general purpose low tensile low hardenability carbon steel generally supplied in the cold drawn or turned and polished condition, with a typical tensile strength range 410 - 790 Mpa, and Brinell hardness range 119 - 235.

Characterised by excellent weldability, very good machinability with reasonable strength and very good ductility.

Sizes are approximate, specifications subject to change without notice.

MACHINERY BUSHINGS

Machinery bushings reduce wear between moving parts, prevent marring of fine finishes and can be used as spacers for sprockets, pulleys and gears on new or old equipment. Made of low carbon, mild steel with plain finish.

18 Gauge (l = light) = 0.042/0.054, 3/64"

14 Gauge (m = medium) = 0.068/0.082, 5/64"

10 Gauge (h = heavy) = 0.126/0.142, 1/8"

Tolerances - O.D. +0.010/-0.010 I.D. +0.010 / +0.025



PART#	IND#	INSIDE DIAMETER	OUTSIDE DIAMETER	GAUGE	QTY.	PART#	IND#	INSIDE DIAMETER	OUTSIDE DIAMETER	GAUGE	QTY.
22700	M-16L	9/16"	1"	18	Pkg. of 10	22722	M-36H	1-1/2"	2-1/4"	10	Pkg. of 10
22701	M-18L	5/8"	1-1/8"	18	Pkg. of 10	22723	M-38M	1-5/8"	2-3/8"	14	Pkg. of 10
22702	M-18M	5/8"	1-1/8"	14	Pkg. of 10	22724	M-38H	1-5/8"	2-3/8"	10	Pkg. of 10
22703	M-20L	3/4"	1-1/4"	18	Pkg. of 10	22725	M-40M	1-3/4"	2-1/2"	14	Pkg. of 10
22704	M-20M	3/4"	1-1/4"	14	Pkg. of 10	22726	M-40H	1-3/4"	2-1/2"	10	Pkg. of 10
22705	M-20H	3/4"	1-1/4"	10	Pkg. of 10	22727	M-46M	1-7/8"	2-7/8"	14	Pkg. of 10
22706	M-22L	7/8"	1-3/8"	18	Pkg. of 10	22728	M-46H	1-7/8"	2-7/8"	10	Pkg. of 10
22707	M-22M	7/8"	1-3/8"	14	Pkg. of 10	22729	M-48M	2"	3"	14	Pkg. of 10
22708	M-24L	1"	1-1/2"	18	Pkg. of 10	22730	M-48H	2"	3"	10	Pkg. of 10
22709	M-24M	1"	1-1/2"	14	Pkg. of 10	22731	M-50M	2-1/8"	3-1/8"	14	Pkg. of 10
22710	M-24H	1"	1-1/2"	10	Pkg. of 10	22732	M-50H	2-1/8"	3-1/8"	10	Pkg. of 10
22711	M-28L	1-1/8"	1-3/4"	18	Pkg. of 10	22733	M-52M	2-1/4"	3-1/4"	14	Pkg. of 10
22712	M-28M	1-1/8"	1-3/4"	14	Pkg. of 10	22734	M-52H	2-1/4"	3-1/4"	10	Pkg. of 10
22713	M-28H	1-1/8"	1-3/4"	10	Pkg. of 10	22735	M-54M	2-3/8"	3-3/8"	14	Pkg. of 10
22714	M-30L	1-1/4"	1-7/8"	18	Pkg. of 10	22736	M-54H	2-3/8"	3-3/8"	10	Pkg. of 10
22715	M-30M	1-1/4"	1-7/8"	14	Pkg. of 10	22737	M-56M	2-1/2"	3-1/2"	14	Pkg. of 10
22716	M-30H	1-1/4"	1-7/8"	10	Pkg. of 10	22738	M-56H	2-1/2"	3-1/2"	10	Pkg. of 10
22717	M-34L	1-3/8"	2-1/8"	18	Pkg. of 10						
22718	M-34M	1-3/8"	2-1/8"	14	Pkg. of 10						
22719	M-34H	1-3/8"	2-1/8"	10	Pkg. of 10						
22720	M-36L	1-1/2"	2-1/4"	18	Pkg. of 10						
22721	M-36M	1-1/2"	2-1/4"	14	Pkg. of 10						

Reference Charts

See the reference charts on pages 36 - 37, for sizing.

Sizes are approximate, specifications subject to change without notice.

SPRINGS MERCHANDISER - BULK



PART#

CONTENTS

- 00243** Bulk Springs Display 24" x 24" Photo Board (features actual size photos)
- 00243K** Bulk Springs Assortment Merchandiser - A complete (900 pieces). Also includes cabinet, 4 drawers and 00243 Photo Display Board, 24" x 24".
- 00243C** *Cabinet Only* - Cabinet size is 20" wide x 14-1/2" high x 15-3/4" deep.



00243C

- Drawers with lids easily pull open
- Bulk springs Merchandisers takes up less space than packaged springs
- Cabinet holds 100 types of springs.

Illustrations or photos may not be exactly as shown.

BULK SPRINGS

PART#	REF#	TYPE	MEASUREMENTS	WIRE DIA.	ASSORT. QTY.	REFILL QTY.	PART#	REF#	TYPE	MEASUREMENTS	WIRE DIA.	ASSORT. QTY.	REFILL QTY.
26001	1	Ext.	5/32" x 1-7/8"	0.02"	11	12	26027	27	Ext.	1/2" x 3-5/8"	0.062"	8	12
26002	2	Ext.	1/4" x 2-1/2"	0.035"	11	12	26028	28	Ext.	3/4" x 2-5/16"	0.105"	8	12
26003	3	Ext.	1/4" x 2-1/4"	0.032"	11	12	26029	29	Ext.	7/16" x 3-11/16"	0.047"	8	12
26004	4	Ext.	5/16" x 2-11/16"	0.041"	11	12	26030	30	Ext.	1/2" x 3-13/16"	0.041"	11	12
26005	5	Ext.	1/2" x 2-5/16"	0.062"	8	12	26031	31	Ext.	3/4" x 1-15/16"	0.105"	11	12
26006	6	Ext.	3/8" x 2"	0.035"	11	12	26032	32	Comp.	7/16" x 3-1/4"	0.062"	23	12
26007	7	Cone C	13/32"x11/16"x1"	0.041"	11	12	26033	33	Comp.	21/64" x 3-5/16"	0.047"	8	12
26008	8	Ext.	15/32" x 2-7/16"	0.054"	5	12	26034	34	Ext.	3/4" x 1-3/4"	0.105"	11	12
26009	9	Ext.	7/16" x 2-15/16"	0.062"	5	12.	26035	35	Comp.	15/32" x 2-3/8"	0.08"	8	12
26010	10	Ext.	13/32" x 2-3/4"	0.041"	5	12	26036	36	Ext.	5/16" x 3-7/16"	0.041"	8	12
26011	11	Ext.	3/8" x 2-11/16"	0.047"	5	12	26037	37	Comp.	15/32" x 1-1/8"	0.047"	11	12
26012	12	Brl C	7/16" x 11/16" x 2"	0.047"	8	12	26038	38	Ext.	9/32" x 6-1/2"	0.041"	8	12
26013	13	Comp.	1/2" x 1-3/4"	0.054"	8	12	26039	39	Comp.	11/16" x 1-1/8"	0.08"	11	12
26014	14	Comp.	5/8" x 1-3/4"	0.091"	5	12	26040	40	Ext.	5/8" x 5-3/8"	0.062"	3	6
26015	15	Torsion	1/16" x 1/2"	0.072"	8	12	26041	41	Comp.	1/2" x 2-13/16"	0.062"	8	6
26016	16	Comp.	5/8" x 2"	0.072"	8	12	26042	42	Ext.	1/2" x 6"	0.08"	3	6
26017	17	Comp.	5/16" x 1-3/8"	0.041"	11	12	26043	43	Comp.	11/16" x 3"	0.062"	5	6
26018	18	Comp.	5/16" x 1-1/2"	0.02"	11	12	26044	44	Ext.	5/8" x 5-7/8"	0.08"	3	6
26019	19	Comp.	13/64" x 2-1/4"	0.032"	23	12	26045	45	Comp.	3/4" x 3-3/8"	0.047"	8	6
26020	20	Comp.	7/32" x 1-5/8"	0.015"	23	12	26046	46	Ext.	21/32" x 4-7/8"	0.041"	3	6
26021	21	Comp.	3/16" x 1-5/16"	0.022"	17	12	26047	47	Comp.	7/8" x 3-7/16"	0.08"	3	6
26022	22	Comp.	7/32" x 1-1/4"	0.032"	23	12	26048	48	Comp.	7/16" x 5"	0.08"	3	6
26023	23	Comp.	5/16" x 1-7/8"	0.026"	23	12	26049	49	Comp.	31/32" x 3-3/4"	0.105"	3	6
26024	24	Comp.	5/16" x 1-7/8"	0.041"	11	12	26050	50	Ext.	15/32" x 6-3/4"	0.047"	3	6
26025	25	Comp.	1/4" x 2"	0.023"	29	12	26051	51	Ext.	11/32" x 5"	0.035"	3	6
26026	26	Comp.	7/16" x 3"	0.047"	8	12	26052	52	Ext.	7/16" x 5"	0.047"	3	6

BULK SPRINGS

PART#	REF#	TYPE	MEASUREMENTS	WIRE DIA.	ASSORT. QTY.	REFILL QTY.	PART#	REF#	TYPE	MEASUREMENTS	WIRE DIA.	ASSORT. QTY.	REFILL QTY.
26053	53	Ext.	9/16" x 3-15/16"	0.072"	5	6	26077	77X	Comp.	3/8" x 1-7/16"	0.035"	11	12
26054	54	Comp.	15/32" x 5-1/4"	0.041"	8	6	26078	78X	Ext.	5/16" x 1-11/16"	0.041"	11	12
26055	55	Comp.	13/16" x 3-1/4"	0.062"	5	6	26079	79X	Comp.	3/8" x 1-15/16"	0.041"	11	12
26056	56	Comp.	1-1/32" x 5-3/8"	0.120"	2	6	26080	80X	Comp.	1/2" x 1-7/16"	0.062"	11	12
26057	57	Comp.	3/4X3"	0.105"	5	6	26081	81X	Ext.	3/16" x 1-11/16"	0.028"	8	12
26058	58	Comp.	1-1/4" x 4-5/8"	0.120"	2	6	26082	82X	Comp.	1/12" x 1-3/4"	0.047"	8	12
26059	59	Comp.	1" x 3-3/4"	0.135"	2	6	26083	83X	Ext.	7/32" x 2"	0.032"	8	12
26060	60	Comp.	11/16" x 9-1/2"	0.072"	2	6	26084	84X	Comp.	7/16" x 1-7/16"	0.041"	11	12
26061	61	Comp.	15/16" x 9-7/8"	0.120"	2	6	26085	85X	Comp.	5/8" x 1-9/16"	0.054"	11	12
26062	62	Ext.	1/2" x 9-3/4"	0.062"	2	6	26086	86X	Ext.	3/16" x 2"	0.035"	8	12
26063	63	Ext.	3/4"x10-1/4"	.091"	2	6	26087	87X	Comp.	15/64"x1-3/4"	.032"	11	12
26064	64	Ext.	3/4"x8"	.105"	2	6	26088	88X	Ext.	3/8"x2"	.041"	8	12
26065	65	Ext.	5/8"x2-11/16"	.041"	11	12	26089	89X	Comp.	5/8"x2"	.062"	11	12
26066	66X	Ext.	3/8"x2-3/16"	.062"	8	12	26090	90X	Comp.	5/16"x1-1/2"	.035"	11	12
26067	67X	Comp.	21/64" x 1-1/8"	0.028"	14	12	26091	91X	Ext.	9/32"x2-7/16"	.035"	8	12
26068	68X	Ext.	5/16"x2-3/16"	.041"	8	12	26092	92X	Comp.	5/16"x1-11/16"	.032"	11	12
26069	69X	Comp.	1/4"x2"	.020"	11	12	26093	93X	Ext.	1/4"x2-5/16"	.020"	8	12
26070	70X	Ext.	5/16"x2-1/8"	.032"	11	12	26094	94X	Comp.	1/4" x 2"	0.025"	11	12
26071	71X	Comp.	3/16"x1-1/2"	.020"	11	12	26095	95X	Comp.	5/16" x 1-1/2"	0.047"	14	12
26072	72X	Comp.	1/4"x1-7/8"	.022"	11	12	26096	96X	Comp.	3/8" x 1-1/2"	0.047"	11	12
26073	73X	Ext.	7/16" x 1-15/16"	0.054"	8	12	26097	97X	Ext.	3/8" x 2-3/16"	0.047"	8	12
26074	74X	Comp.	5/16" x 1-7/16"	0.025"	11	12	26098	98X	Comp.	1/4" x 1-7/16"	0.032"	11	12
26075	75X	Ext.	15/64"x1-1/2"	.028"	11	12	26099	99X	Comp.	3/8" x 1-7/8"	0.025"	11	12
26076	76X	Comp.	5/16"x2"	.041"	11	12	26100	100X	Ext.	15/32" x 2-1/4"	0.041"	8	12



Packaged Extension Springs

S.A.E. 1060-1090 spring steel. Phosphate and oil finish.
Retail package with UPC barcode label.

PART#	REF#	WIRE DIAMETER	OUTSIDE DIAMETER	OVERALL LENGTH	BODY LENGTH	MAX- IMUM STRETCH	LOAD RATE (LB/IN)	MAXIMUM LOAD (LB)	PKG. QTY.
24001	C-1	0.015"	0.125"	1.5"	0.125"	2"	0.65	1.4	2
24005	C-5	0.02"	0.156"	1.5"	1.188"	1.7"	1.50	2.7	2
24013	C-13	0.023"	0.218"	1.5"	1.064"	2.4"	1.10	2.9	2
24019	C-19	0.035"	0.25"	1.5"	1"	1.1"	6.40	8.4	2
24023	C-23	0.025"	0.281"	1.5"	0.938"	3.4"	0.74	2.8	2
24025	C-25	0.02"	0.312"	1.5"	0.876"	7.7"	0.17	1.4	2
24029	C-29	0.028"	0.343"	1.5"	0.814"	3.2"	0.81	3.6	2
24031	C-31	0.028"	0.437"	1.5"	0.626"	4.4"	0.54	2.5	2
24033	C-33	0.047"	0.437"	1.5"	0.626"	1.6"	6.20	11	2
24051	C-51	0.014"	0.125"	1.875"	1.625"	3.3"	0.35	1.3	2
24055	C-55	0.02"	0.156"	1.875"	1.563"	2.7"	1.10	2.2	2
24063	C-63	0.023"	0.218"	1.875"	1.439"	3.4"	0.79	2.9	2
24067	C-67	0.02"	0.25"	1.875"	1.375"	6.4"	0.25	1.7	2
24069	C-69	0.035"	0.25"	1.875"	1.375"	1.5"	4.70	8.4	2
24073	C-73	0.025"	0.281"	1.875"	1.313"	2.8"	0.54	4.7	2
24077	C-77	0.025"	0.313"	1.875"	1.189"	6.8"	0.31	2.3	2
24081	C-81	0.028"	0.437"	1.875"	1"	7.8"	0.30	2.5	2
24083	C-83	0.047"	0.437"	1.875"	1"	2.3"	4.30	11	2
24103	C-103	0.018"	0.125"	2.5"	2.25"	2.2"	0.96	2.5	2
24105	C-105	0.02"	0.156"	2.5"	2.188"	3"	0.81	2.7	2
24111	C-111	0.025"	0.187"	2.5"	2.126"	2.5"	1.50	4.2	2
24115	C-115	0.016"	0.25"	2.5"	2"	15"	0.50	0.87	2
24117	C-117	0.02"	0.25"	2.5"	2"	9"	0.17	1.7	2
24119	C-119	0.035"	0.25"	2.5"	2"	2.1"	3.50	8.4	2
24131	C-131	0.028"	0.437"	2.5"	1.626"	13"	0.18	2.5	2
24133	C-133	0.047"	0.437"	2.5"	1.665"	3.4"	3.00	11	2
24135	C-135	0.062"	0.437"	2"	1.126"	0.87"	17.00	19	2
24139	C-139	0.054"	0.437"	3.5"	2.626"	2.5"	4.00	12	2
24141	C-141	0.072"	0.625"	2.5"	1.375"	1.5"	10.00	19	2
24143	C-143	0.054"	0.562"	3"	1.875"	3.4"	2.30	9.2	2

Packaged Extension Springs

S.A.E. 1060-1090 spring steel. Phosphate and oil finish.
Retail package with UPC barcode label.

PART#	REF#	WIRE DIAMETER	OUTSIDE DIAMETER	OVERALL LENGTH	BODY LENGTH	MAXIMUM STRETCH	LOAD RATE (LB/IN)	MAXIMUM LOAD (LB)	PKG. QTY.
24155	C-155	0.028"	0.312"	3"	2.375"	7.8"	0.41	3.5	2
24157	C-157	0.025"	0.25"	3.25"	2.75"	6.4"	0.44	3.1	2
24161	C-161	0.035"	0.437"	2.75"	1.875"	5.9"	5.00	3.3	2
24163	C-163	0.047"	0.437"	3.5"	2.626"	3.6"	2.00	8.4	2
24165	C-165	0.08"	0.5"	1.625"	0.625"	2"	66.00	35	2
24171	C-171	0.105"	0.75"	2"	0.5"	2.59"	92.00	60	2
24173	C-173	0.105"	0.75"	2.25"	0.75"	3"	68.00	60	2
24175	C-175	0.105"	0.75"	2.437"	0.9375"	3.3"	47.00	50	2
24177	C-177	0.105"	0.75"	2.625"	1.125"	3.625"	38.00	50	2
24179	C-179	0.072"	0.562"	2.875"	1.75"	4.475"	11.00	22	2
24181	C-181	0.072"	0.625"	3.25"	2"	5.6"	6.40	19	2
24183	C-183	0.047"	0.562"	4"	2.91"	11.6"	0.76	6.5	2
24185	C-185	0.062"	0.75"	3.5"	2"	9"	1.70	11	2
24187	C-187	0.105"	0.75"	2.875"	1.375"	N/A	39.00	60	2
24189	C-189	0.105"	0.75"	3.125"	1.625"	4.3"	33.00	50	2
24191	C-191	0.105"	0.75"	3.75"	2.25"	6"	26.00	50	2
24193	C-193	0.035"	0.375"	4"	3.25"	11.3"	0.47	3.9	2
24205	C-205	0.035"	0.25"	5"	4.5"	8.5"	1.40	6	2
24209	C-209	0.028"	0.375"	4.5"	3.75"	18"	0.15	2.9	2
24215	C-215	0.041"	0.375"	3.75"	3"	7.5"	1.40	6.5	2
24219	C-219	0.041"	0.468"	4.5"	3.564"	13"	0.54	5.2	2
24221	C-221	0.062"	0.5"	4.5"	3.5"	7.7"	4.10	16	2
24223	C-223	0.072"	0.5"	5"	4"	7.3"	8.20	25	2
24227	C-227	0.091"	0.687"	4.75"	3.875"	7.25"	11.00	35	2
24231	C-231	0.072"	0.562"	6"	4.876"	9.8"	4.60	22	2
24233	C-233	0.035"	0.25"	6"	5.5"	10.3"	1.10	6	2
24235	C-235	0.028"	0.312"	6"	5.375"	21"	0.23	3.9	2
24239	C-239	0.047"	0.375"	6.5"	5.75"	11.5"	1.60	10	2
24243	C-243	0.054"	0.625"	6.5"	5.25"	17.5"	0.65	8.3	2
24251	C-251	0.105"	1.125"	16"	13.75"	38"	1.20	31	1
24253	C-253	0.054"	0.562"	16.5"	15.375"	41.5"	0.32	9.2	1

continued on next page





Packaged Extension Springs

PART#	REF#	WIRE DIAMETER	OUTSIDE DIAMETER	OVERALL LENGTH	BODY LENGTH	MAX- IMUM STRETCH	LOAD RATE (LB/IN)	MAXIMUM LOAD(LB)	PKG. QTY.
24257	C-257	0.091"	0.812"	4.5"	3.375"	7.8"	7.10	29	2
24259	C-259	0.12"	0.812"	4"	2.375"	1.3"	39.00	66	2
24261	C-261	0.12"	1.062"	5.5"	3.375"	9.7"	9.50	49	1
24263	C-263	0.091"	0.785"	6"	4.875"	11.6"	3.90	26	1
24265	C-265	0.105"	1.062"	7"	4.875"	14.5"	3.70	33	1
24267	C-267	0.162"	1.25"	6.5"	4"	9.5"	26.00	100	1
24269	C-269	0.135"	1"	7"	5"	10"	18.00	75	1
24271	C-271	0.08"	1.062"	8.5"	6.375"	27.5"	0.69	15	1
24273	C-273	0.148"	1.125"	8.5"	6.25"	12.9"	15.00	87	1
24275	C-275	0.091"	1.125"	7.5"	6.312"	20.5"	1.30	20	1
24277	C-277	0.091"	0.65"	6.5"	5.5"	10.5"	5.90	31	1
24281	C-281	0.062"	0.375"	5.5"	5"	7.4"	8.90	23	2
24285	C-285	0.035"	0.375"	5"	4.25"	16"	0.43	5.4	2
24287	C-287	0.032"	0.312"	5"	4.375"	14.8"	0.48	5.2	2
24289	C-289	0.035"	0.312"	5"	4.375"	12.4"	0.79	6.6	2
24293	C-293	0.062"	0.375"	6.75"	6"	2.5"	6.80	23	1
24301	C-301	0.135"	1.5"	11.5"	8.5"	26.5"	2.70	47	1
24303	C-303	0.105"	1"	12"	10"	24"	2.40	35	1
24307	C-307	0.135"	1.062"	12"	9.875"	19"	7.70	69	1
24311	C-311	0.041"	0.437"	10.25"	9.375"	27"	0.28	5.5	1
24313	C-313	0.047"	0.5"	8.5"	7.5"	22.5"	0.46	7.2	1
24315	C-315	0.047"	0.437"	8.5"	7.626"	18"	0.73	8.4	1
24317	C-317	0.091"	0.625"	8.5"	7.25"	12.3"	7.70	39	1
24319	C-319	0.054"	0.562"	8.5"	7.376"	20"	0.64	9.2	1
24321	C-321	0.062"	0.625"	8.5"	7.75"	19.5"	0.95	13	1
24323	C-323	0.08"	0.625"	8.5"	7.25"	14"	3.90	27	1
24325	C-325	0.062"	0.875"	8.5"	6.75"	32"	0.33	8.8	1
24329	C-329	0.105"	0.875"	8.5"	6.75"	14"	5.40	41	1
24333	C-333	0.135"	0.875"	9"	7.25"	12"	20.00	87	1
24337	C-337	0.12"	1"	8.5"	6.5"	13"	7.70	52	1
24339	C-339	0.148"	1.25"	10"	7.5"	16.5"	9.20	77	1

Drawbar Spring

S.A.E. 1060-1090 Spring steel. Phosphate & oil finish, UPC barcode label.

PART#	REF#	WIRE DIAMETER	OUTSIDE DIAMETER	OVERALL LENGTH	LOAD RATE (LB/IN)	MAXIMUM LOAD (LB)
24900	4001	0.227"	1-9/16"	7-1/4"	152.78	330.31

Packaged Compression Springs

S.A.E. 1060-1090 spring steel. Phosphate and oil finish.
Retail package with UPC barcode label.

PART#	REF#	WIRE DIAMETER	OUTSIDE DIAMETER	OVERALL LENGTH	SOLID HEIGHT	TOTAL COILS	LOADRATE (LB/IN)	MAXIMUM LOAD (LB)	PKG. QTY.
24500	C-500	0.023"	0.156"	0.562"	0.28	11	19.00	4.5	6
24510	C-510	0.035"	0.25"	0.5"	0.26	7	42.00	6.2	6
24516	C-516	0.011"	0.156"	1"	0.14	12	0.73	0.57	6
24520	C-520	0.016"	0.187"	0.875"	0.27	16	1.30	0.81	6
24526	C-526	0.028"	0.187"	1"	0.48	17	15.00	6.3	6
24530	C-530	0.02"	0.218"	1"	0.24	11	3.30	2.2	6
24532	C-532	0.013"	0.187"	1"	0.14	10	0.99	0.78	6
24550	C-550	0.016"	0.187"	1"	0.2	12	2.00	1.3	6
24554	C-554	0.02"	0.25"	1"	0.2	9	2.80	1.9	6
24556	C-556	0.026"	0.312"	0.625"	0.18	7	7.00	3.1	6
24562	C-562	0.035"	0.25"	1"	0.46	12	21.00	8.9	6
24566	C-566	0.032"	0.375"	0.75"	0.22	6	7.70	3.2	6
24570	C-570	0.014"	0.125"	1.375"	0.34	27	1.60	1.4	6
24576	C-576	0.016"	0.156"	1.375"	0.35	21	1.80	1.6	6
24578	C-578	0.013"	0.187"	1.375"	0.18	12	0.71	0.78	6
24580	C-580	0.028"	0.187"	1.375"	0.65	23	11.00	6.3	6
24582	C-582	0.016"	0.187"	1.375"	0.26	15	1.40	1.3	6
24600	C-600	0.02"	0.218"	1.375"	0.31	15	2.40	2.2	4
24604	C-604	0.023"	0.218"	1.375"	0.39	16	3.90	3.3	4
24608	C-608	0.02"	0.25"	1.375"	0.25	12	2.00	1.9	4
24612	C-612	0.028"	0.281"	1.375"	0.43	15	4.40	4.1	4
24614	C-614	0.041"	0.312"	1.25"	0.62	15	17.00	8.3	4
24624	C-624	0.041"	0.375"	1.125"	0.46	10	13.00	7	4
24632	C-632	0.041"	0.437"	1.062"	0.36	8	11.00	6.1	4
24650	C-650	0.013"	0.218"	1.75"	0.247	18	0.29	0.44	4
24652	C-652	0.028"	0.218"	1.375"	0.53	18	8.10	5.5	4
24660	C-660	0.016"	0.312"	1.75"	0.2	12	0.39	0.61	4
24664	C-664	0.047"	0.343"	1.5"	0.71	15	23.00	11	4
24668	C-668	0.026"	0.375"	1.5"	0.26	10	1.70	2.2	4
24672	C-672	0.035"	0.375"	1.75"	0.54	16	3.70	4.2	4
24676	C-676	0.032"	0.437"	2.125"	0.39	12	2.00	2.8	4
24680	C-680	0.047"	0.312"	2"	1.14	24	18.00	12	4
24690	C-690	0.041"	0.437"	2.25"	0.67	16	4.90	6.1	2
24692	C-692	0.041"	0.625"	1.5"	0.37	9	3.40	3.8	2

continued on next page



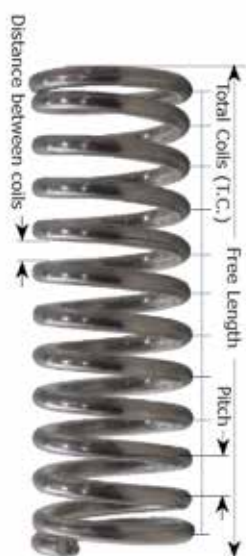

Packaged Compression Springs

PART#	REF#	WIRE DIAMETER	OUTSIDE DIAMETER	OVERALL LENGTH	SOLID HEIGHT	TOTAL COILS	LOADRATE (LB/IN)	MAXIMUM LOAD (LB)	PKG. QTY.
24700	C-700	0.062"	0.5"	1"	0.54	8	45.00	17	2
24702	C-702	0.054"	0.562	1"	0.38	7	16	9.5	2
24704	C-704	0.041"	0.5"	1.5"	0.45	10	5.30	5.4	2
24706	C-706	0.072"	0.562"	1.375"	0.74	10	45	22	2
24712	C-712	0.091"	0.687"	1.25"	0.75	8	89	35	2
24714	C-714	0.062"	0.375"	2.25"	1.46	22	34	22	2
24720	C-720	0.062"	0.5"	1.75"	0.85	14	24	17	2
24722	C-722	0.047"	0.5"	2"	0.635	13	7.19	N/A	2
24724	C-724	0.054"	0.437"	2"	0.89	16	16	13	2
24730	C-730	0.047"	0.406"	2.75"	1.12	23	7.30	9.7	2
24736	C-736	0.072"	0.5"	2.75"	1.48	19	28	25	2
24740	C-740	0.08"	0.625"	2.5"	1.14	14	32	27	2
24742	C-742	0.054"	0.625"	2.75"	0.77	14	5.80	9.1	2
24750	C-750	0.08"	0.75"	2"	0.78	10	25	23	2
24752	C-752	0.08"	0.937"	2"	0.67	8	17	19	2
24756	C-756	0.041"	0.718"	3.5"	0.47	11	1.50	3.8	2
24766	C-766	0.054"	0.562"	3"	0.96	17	6.30	10	2
24768	C-768	0.105"	0.812"	2.25"	1.26	11	54.94	N/A	2
24782	C-782	0.08"	0.625"	3"	1.34	16	26	27	2
24792	C-792	0.105"	0.875"	3"	1.39	14	34	43	2
24802	C-802	0.148"	1.375"	4.375"	1.83	13	36	72	1
24806	C-806	0.148"	1.5"	3.25"	1.26	9	43	67	1
24814	C-814	0.135"	1.375"	2.5"	0.98	8	48	55	2
24818	C-818	0.12"	1.125"	4"	1.72	13	26	48	1
24822	C-822	0.148"	0.937"	4"	2.63	12	89	103	2
24826	C-826	0.12"	1"	3.5"	1.71	15	36	54	2
24830	C-830	0.12"	1.125"	3"	1	10	22	34	2
24832	C-832	0.12"	1"	3"	1.41	12	45	54	2
24834	C-834	0.12"	1.187"	2.75"	1.2	9	35	46	2
24836	C-836	0.08"	0.875"	4"	1.28	15	9	20	2
24838	C-838	0.08"	0.75"	3.5"	1.38	16	14	23	2
24850	C-850	0.091"	0.625"	5"	2.64	29	29	38	2
24856	C-856	0.091"	0.75"	6"	2.78	30	13	32	2
24858	C-858	0.072"	0.687"	6"	2.16	29	6.20	18	2
24864	C-864	0.091"	0.875"	6"	2.18	23	9.30	28	1
24874	C-874	0.12"	1.375"	6"	1.08	14	13	40	1
24878	C-878	0.08"	0.625"	9"	3.72	45	8.40	27	1
24892	C-892	0.162"	1.125"	7"	4	24	49	111	1

RETAINER RINGS

Retaining Rings are precision engineered components that are designed to be applied on shafts or in bores and provide a shoulder that accurately positions, locates and retains other parts of an assembly.

Many different types of retaining rings have been developed over the years, each a solution to a specific problem. Different types of rings are available to solve issues such as: tolerance take-up, clearance diameter, thrust load capacity, flexible installation, rpm capacity, impact loading, non-removable lock-rings, groove-less push-on fastening and radial installation.

As an engineering concept, the retaining ring is still relatively young and has certainly not yet reached its peak of utilization as a retaining device.

How are retaining rings used?

Retaining Rings work by creating a shoulder that can hold components in place. The retaining shoulder is created when the ring attaches itself to the bore or shaft, typically by snapping into a groove. Ordinarily (however not always) a groove is dug into the shaft or bore, and this groove becomes the seat for the retaining ring.

Retaining rings are designed such that their contact diameter has some interference fit with the groove in which they fit. This creates a "snug" fit between the ring and groove. The term used to describe the amount of interference fit is "cling".

Cling causes the retaining ring to fit tightly and securely against its groove bottom. Without cling a ring would have a loose fit and would "rattle" in its groove. This lack of cling would decrease the retention capacity of the ring because a "cling-less" ring is free to move radially, creating weak retention points that will ultimately cause the assembly to fail.

Another key factor is the width of the groove. The groove width is slightly larger than the rings thickness, thus creating a snug axial fit. The tight axial fit along with the cling to the groove bottom create a rigid shoulder which can retain thrust loads.

E Retainer Rings

The universally used radially assembled circlip for shafts. The groove is gripped by 3 tabs. Applications in vehicle construction, optical and electronic industry, and light mechanical industry. Cross reference to 1000, 1500, 5133,ms-16633 series. S.A.E. 1060-1090 Spring steel. Phosphate & oil finish. 10 pieces per pkg.

PART#	IND#	SHAFT DECIMAL	SHAFT FRACTION	RING OUTSIDE DIAMETER	RING THICK- NESS	GROOVE DIAME- TER	GROOVE DEPTH	GROOVE WIDTH	WEIGHT (LB) /100 PIECES
22860	12	0.125	1/8"	0.23	0.015	0.10	0.02	0.02	0.0087
22861	18	0.188	3/16"	0.335	0.025	0.15	0.02	0.029	0.029
22862	25	0.25	1/4"	0.527	0.025	0.21	0.02	0.029	0.076
22863	31	0.312	5/16"	0.5	0.025	0.25	0.03	0.029	0.057
22864	37	0.375	3/8"	0.66	0.035	0.30	0.04	0.039	0.15
22865	43	0.438	7/16"	0.687	0.035	0.34	0.05	0.039	0.15
22866	50	0.5	1/2"	0.8	0.042	0.40	0.05	0.046	0.25
22867	62	0.625	5/8"	0.94	0.042	0.49	0.07	0.046	0.32
22868	75	0.75	3/4"	1.12	0.05	0.58	0.09	0.056	0.58
22869	87	0.875	7/8"	1.3	0.05	0.68	0.10	0.056	0.76
22870	98	0.984	1"	1.5	0.05	0.84	0.08	0.056	0.92
22871	118	1.188	1-3/16"	1.626	0.062	1.08	0.05	0.068	1.13
22872	137	1.375	1-3/8"	1.875	0.062	1.23	0.07	0.068	1.54

Reference Charts

See the reference charts on page 38, for sizing.



Internal Retainer Rings

The universally applicable rings for shafts and bores. Applications in all branches of industry and machine, instrument and vehicle construction. Cross reference to 1300, 3000, 5000, HO, MS-16625 series. S.A.E. 1060-1090 Spring steel. Phosphate and oil finish.

Reference Charts

See the reference charts on page 38 - 41, for sizing.



PART#	IND#	BORE DECIMAL	BORE FRACTION	RING OUTSIDE DIAMETER	RING THICKNESS	GROOVE DIAMETER	GROOVE DEPTH	GROOVE WIDTH	PKG. QTY.
22873	25	0.25	1/4"	0.28	0.015	0.27	0.01	0.02	10
22874	31	0.312	5/16"	0.346	0.015	0.33	0.01	0.02	10
22875	37	0.375	3/8"	0.415	0.025	0.40	0.01	0.029	10
22876	43	0.438	7/16"	0.482	0.025	0.46	0.01	0.029	10
22878	50	0.5	1/2"	0.548	0.035	0.53	0.02	0.039	10
22879	56	0.562	9/16"	0.62	0.035	0.60	0.02	0.039	10
22880	62	0.625	5/8"	0.694	0.035	0.67	0.02	0.039	10
22881	68	0.688	11/16"	0.763	0.035	0.73	0.02	0.039	10
22882	75	0.75	3/4"	0.831	0.035	0.80	0.02	0.039	10
22884	87	0.875	7/8"	0.971	0.042	0.93	0.03	0.046	10
22885	93	0.938	15/16"	1.041	0.042	1.00	0.03	0.046	10
22886	100	1	1"	1.111	0.042	1.07	0.03	0.046	10
22888	106	1.062	1-1/16"	1.18	0.05	1.13	0.03	0.056	10
22889	112	1.125	1-1/8"	1.249	0.05	1.20	0.04	0.056	10
22890	118	1.188	1-3/16"	1.319	0.05	1.26	0.04	0.056	10
22891	125	1.25	1-1/4"	1.388	0.05	1.33	0.04	0.056	10
22892	131	1.312	1-5/16"	1.456	0.05	1.40	0.04	0.056	10
22893	137	1.375	1-3/8"	1.526	0.05	1.46	0.04	0.056	10
22894	143	1.438	1-7/16"	1.596	0.05	1.53	0.05	0.056	10
22895	150	1.5	1-1/2"	1.66	0.05	1.59	0.05	0.056	10
22896	156	1.562	1-9/16"	1.734	0.062	1.66	0.05	0.068	10
22897	162	1.625	1-5/8"	1.804	0.062	1.73	0.05	0.068	10
22900	175	1.75	1-3/4"	1.942	0.062	1.86	0.05	0.068	10
22901	181	1.812	1-13/16"	2.012	0.062	1.92	0.06	0.068	10
22902	187	1.875	1-7/8"	2.072	0.062	1.99	0.06	0.068	10
22903	193	1.938	1-15/16"	2.141	0.062	2.06	0.06	0.068	10
22904	200	2	2"	2.21	0.062	2.12	0.06	0.068	10
22905	206	2.062	2-1/16"	2.28	0.078	2.19	0.06	0.086	5
22906	212	2.125	2-1/8"	2.35	0.078	2.25	0.06	0.086	5
22907	225	2.25	2-1/4"	2.49	0.078	2.38	0.07	0.086	5
22908	237	2.375	2-3/8"	2.63	0.078	2.52	0.07	0.086	5
22909	244	2.44	2-7/16"	2.702	0.078	2.58	0.07	0.086	5
22910	250	2.5	2-1/2"	2.775	0.078	2.65	0.07	0.086	5
22911	262	2.625	2-5/8"	2.91	0.093	2.78	0.08	0.103	5
22912	268	2.688	2-11/16"	2.98	0.093	2.85	0.08	0.103	5
22913	275	2.75	2-3/4"	3.05	0.093	2.91	0.08	0.103	5
22914	281	2.812	2-13/16"	3.121	0.093	2.98	0.08	0.103	5
22915	287	2.875	2-7/8"	3.191	0.093	3.05	0.09	0.103	2
22916	300	3	3"	3.325	0.093	3.18	0.09	0.103	2
22917	325	3.25	3-1/4"	3.623	0.109	3.45	0.10	0.12	2
22918	350	3.5	3-1/2"	3.89	0.109	3.71	0.11	0.12	2
22919	400	4	4"	4.424	0.109	4.24	0.12	0.12	2
22920	450	4.5	4-1/2"	4.94	0.109	4.74	0.12	0.12	2
22921	500	5	5"	5.485	0.109	5.26	0.13	0.12	2
22922	550	5.5	5-1/2"	6.066	0.125	5.77	0.14	0.139	2
22923	600	6	6"	6.62	0.125	6.27	0.14	0.139	2

PART#	IND#	SHAFT DECIMAL	SHAFT FRACTION	RING OUTSIDE DIAMETER	RING THICK- NESS	GROOVE DIAMETER	GROOVE DEPTH	GROOVE WIDTH	PKG. QTY.
22924	18	0.188	3/16"	0.168	0.015	0.18	0.01	0.018	10
22925	25	0.25	1/4"	0.225	0.025	0.23	0.01	0.029	10
22926	31	0.312	5/16"	0.281	0.025	0.29	0.01	0.029	10
22928	37	0.375	3/8"	0.338	0.025	0.35	0.01	0.029	10
22929	43	0.438	7/16"	0.395	0.025	0.41	0.01	0.029	10
22931	50	0.5	1/2"	0.461	0.035	0.47	0.02	0.039	10
22932	56	0.562	9/16"	0.521	0.035	0.53	0.02	0.039	10
22933	59	0.594	19/32"	0.55	0.035	0.56	0.02	0.039	10
22934	62	0.625	5/8"	0.579	0.035	0.59	0.02	0.039	10
22935	66	0.672	43/64"	0.621	0.035	0.63	0.02	0.039	10
22936	68	0.688	11/16"	0.635	0.042	0.65	0.02	0.046	10
22937	75	0.75	3/4"	0.693	0.042	0.70	0.02	0.046	10
22938	81	0.812	13/16"	0.751	0.042	0.76	0.03	0.046	10
22939	87	0.875	7/8"	0.81	0.042	0.82	0.03	0.046	10
22940	93	0.938	15/16"	0.867	0.042	0.88	0.03	0.046	10
22942	100	1	1"	0.925	0.042	0.94	0.03	0.046	10
22944	106	1.062	1-1/16"	0.982	0.05	1.00	0.03	0.056	10
22945	112	1.125	1-1/8"	1.041	0.05	1.06	0.03	0.056	10
22946	118	1.188	1-3/16"	1.098	0.05	1.12	0.04	0.056	10
22947	125	1.25	1-1/4"	1.156	0.05	1.18	0.04	0.056	10
22948	131	1.312	1-5/16"	1.214	0.05	1.23	0.04	0.056	10
22949	137	1.375	1-3/8"	1.272	0.05	1.29	0.04	0.056	10
22950	143	1.438	1-7/16"	1.333	0.05	1.35	0.04	0.056	10
22951	150	1.5	1-1/2"	1.387	0.05	1.41	0.05	0.056	10
22952	156	1.562	1-9/16"	1.446	0.062	1.47	0.05	0.068	10
22953	162	1.625	1-5/8"	1.503	0.062	1.53	0.05	0.068	10
22954	168	1.688	1-11/16"	1.56	0.062	1.59	0.05	0.068	10
22955	175	1.75	1-3/4"	1.618	0.062	1.65	0.05	0.068	10
22956	187	1.875	1-7/8"	1.735	0.062	1.77	0.05	0.06	10
22957	196	1.969	1-31/32"	1.819	0.062	1.86	0.06	0.068	10
22958	200	2	2"	1.85	0.062	1.89	0.06	0.068	10
22960	212	2.125	2-1/8"	1.964	0.078	2.00	0.06	0.086	5
22962	225	2.25	2-1/4"	2.081	0.078	2.12	0.07	0.086	5
22963	237	2.375	2-3/8"	2.197	0.078	2.24	0.07	0.086	5
22964	243	2.438	2-7/16"	2.255	0.078	2.30	0.07	0.086	5
22965	250	2.5	2-1/2"	2.313	0.078	2.36	0.07	0.086	5
22966	262	2.625	2-5/8"	2.428	0.078	2.48	0.07	0.086	5
22967	275	2.75	2-3/4"	2.543	0.093	2.60	0.07	0.103	2
22968	287	2.875	2-7/8"	2.659	0.093	2.72	0.08	0.1	2
22970	300	3	3"	2.775	0.093	2.84	0.08	0.1	2
22971	350	3.5	3-1/2"	3.237	0.109	3.32	0.09	0.12	2
22972	400	4	4"	3.7	0.109	3.79	0.10	0.12	2
22973	450	4.5	4-1/2"	4.223	0.109	4.31	0.10	0.12	2
22974	500	5	5"	4.692	0.109	4.79	0.11	0.12	2
22975	600	6	6"	5.631	0.125	5.75	0.13	0.139	2

External Retainer Rings (Basic)

The universally applicable rings for shafts and bores. Applications in all branches of industry and machine, instrument and vehicle construction. Cross reference to 1300, 3000, 5000, H0, MS-16625 series.

S.A.E. 1060-1090 spring steel.
Phosphate and oil finish.

Reference Charts

See the reference charts on **page 42 - 44**, for sizing.





11363



11359

NEW!

HOSE REELS

Air Hose Reels - Heavy Duty Steel Frame

Corrosion resistant powder coat finish. Features spring tension brake and solid brass swivel. Mounts on floor, wall or workbench.

PART#	REEL CAPACITY	HOSE DIAMETER	INLET DIAMETER	HOSE OUTLET	MAXIMUM PRESSURE
11362	100 ft.	3/8"	3/8" NPT	3/8" NPT	300 PSI
11363	50 ft.	3/8"	3/8" NPT	3/8" NPT	300 PSI

Industrial Hose Reel

Heavy duty steel assembly. Corrosion resistant powder coat finish. Ratchet gear locks reel at desired hose length. 3/8" heavyduty industrial grade rubber hose. Use for air and water, 3/8" NPT brass fitting.

PART#	HOSE LENGTH	HOSE DIAMETER	MAXIMUM PRESSURE	COLOUR
11369	50 ft.	3/8"	300 PSI	Red
NEW! 11370	100 ft.	3/8"	300 PSI	Black & Yellow

Retractable Hose Reel - Silver Series

Auto rewind, heavy duty steel assembly. Powder coated finish. Self locking mechanism, heavy duty springs. Robust for commercial use. Industrial grade hose for water, oil and air.

PART#	HOSE LENGTH	HOSE DIAMETER	MAXIMUM PRESSURE
11359	35 ft.	1/4"	300 PSI
11360	50 ft.	3/8"	300 PSI
11361	50 ft.	1/2"	300 PSI

Jack Stands

Made of A3 steel. Meets ANSI 2009 Specs. Powder coated finish. Ratchet locking gear. Ideal for auto, home, and shop. 2 per box.

PART#	CAPACITY	ADJUSTABLE HEIGHTS	BASE DIMENSIONS
11548	6,000 lb/ea. stand	11-7/32" to 16-7/8"	7-5/8" x 6-7/8"
11549	13,200 lb/ea. stand	15-1/2" to 23-3/4"	10-13/16" x 9-5/8"
11550	26,400 lb/ea. stand	19-3/8" to 28-1/8"	11-1/2" x 12-5/8"

PULLEY BLOCKS

Standard Single Pulley Block

PART#	SIZE	W.L.L.	ROPE DIAMETER	OVERALL LENGTH	DESCRIPTION
80330	3"	1/2 Ton	8 mm (5/16")	10-3/4"	Loop
80335	3"	1/2 Ton	8 mm (5/16")	11"	Loop, Safety Latch, Access Latch & Grease Fitting



80335

Single Pulley Block

PART#	SIZE	W.L.L.	ROPE DIAMETER	OVERALL LENGTH	DESCRIPTION
80345	4"	1 Ton	10 mm (3/8")	12-1/4"	Access Latch & Grease Fitting
80335	3"	1/2 Ton	8 mm (5/16")	11"	Loop, Safety Latch, Access Latch & Grease Fitting



80345

Standard Double Pulley Block

PART#	SIZE	W.L.L.	ROPE DIAMETER	OVERALL LENGTH	DESCRIPTION
80350	3"	1/2 Ton	8 mm (5/16")	11"	Loop
80355	4"	1 Ton	10 mm (3/8")	13"	Loop



80350

Single Pulley Block With Eye

PART#	SIZE	W.L.L.	ROPE DIAMETER	OVERALL LENGTH	DESCRIPTION
80360	3"	1/2 Ton	8 mm (5/16")	11"	Eye, Access Latch, Safety Latch & Grease Fitting
80365	4"	1 Ton	10 mm (3/8")	13"	Eye, Access Latch, Safety Latch & Grease Fitting



80360



Access Latch



Grease Fitting



SNATCH BLOCKS

Heavy Duty Snatch Block With Hook

PART#	PULLEY DIAMETER	ROPE DIAMETER	W.L.L.	TON
80270	3"	3/8"	4,000 lb	2
80271	4-1/2"	1/2"	8,000 lb	4
80272	6"	3/4"	16,000 lb	8
80273	8"	3/4"	16,000 lb	8

Heavy Duty Snatch Block With Shackle

PART#	PULLEY DIAMETER	ROPE DIAMETER	W.L.L.	TON
80280	3"	3/8"	4,000 lb	2
80281	4-1/2"	1/2"	8,000 lb	4
80282	6"	3/4"	16,000 lb	8
80283	8"	3/4"	16,000 lb	8

Heavy Duty Tailboards

PART#	PULLEY DIAMETER	ROPE DIAMETER	W.L.L.	TON
80290	3"	3/8"	4,000 lb	2
80291	4-1/2"	1/2"	8,000 lb	4
80292	6"	3/4"	16,000 lb	8
80293	8"	3/4"	16,000 lb	8

TROLLEYS

Rugged steel construction. Lifetime lubricated & sealed bearings. Proof tested and certified. Built-in bumper guards. Use on straight or curved tracks. Adjustable to various beams.

PART#	CAPACITY	BEAM WIDTH
80301	1 Ton	2-15/16 - 4-15/16"
80302	2 Ton	3-15/16 - 5-15/16"
80303	3 Ton	3-15/16 - 5-15/16"
80305	5 Ton	4-15/16 - 6-7/8"

BEAM CLAMPS

Rugged steel construction. Proof tested & certified. Use on straight or curved tracks. Adjustable to various beams.

PART#	CAPACITY	BEAM WIDTH
80320	1 Ton	2-15/16 - 8-11/16"
80321	2 Ton	3-1/8 - 12-5/8"
80322	3 Ton	3-1/8 - 12-5/8"
80323	5 Ton	3-9/16 - 12-5/8"

CABLE PULLERS

Designed to lift, stretch, lower or pull heavy loads. Features double ratchet wheel brake system, and hooks with safety latches. Snatch block included.

PART#	CAPACITY	CABLE DIAMETER	CABLE LENGTH	WEIGHT
11351	1 Ton	5/32"	6.0 ft.	1.9 kg
11352	2 Ton	5/32"	7.21 ft.	4.3 kg
11354	4 Ton	3/16"	8.53 ft.	5.2 kg

HOISTS

Lever Hoists

Lightweight, compact and portable. Impact-resistant, rugged steel body construction. Features short, low effort, 360°rotating handle. Equipped with Easy Free chain, Latch-type swivel hooks, and high-tensile alloy chain.

PART#	RATED CAPACITY (TONS)	CHAIN DIAMETER	LIFT	MINIMUM CLEARANCE	LENGTH	TEST LOAD (TONS)	REPLACEMENT HOOKS TOP	REPLACEMENT HOOKS BOTTOM
80259	1/4	3/16"	59"	10-5/8"	10-13/32"	1-5/8	80259-1	80259-2
80260	1/2	3/16"	59"	10-5/8"	10-13/32"	1-5/8	80260-1	80260-2
80261	3/4	7/32"	59"	11-13/32"	10-7/16"	1-1/8	80261-1	80261-2
80262	1	1/4"	59"	12-13/16"	10-7/16"	1-1/2	80262-1	80262-2
80263	1-1/2	9/32"	59"	14-3/16"	16-1/8"	2-1/4	80263-1	80263-2
80264	3	11/32"	59"	18-1/2"	16-1/8"	4-1/2	80264-1	80264-2

Chain Hoists

Lightweight, compact and portable. Impact-resistant, rugged steel body construction. Features short, low effort, 360°rotating handle. Equipped with Easy Free chain, Latch-type swivel hooks, and high-tensile alloy chain.

- Steel Formed Case to protect both gear and hand chain wheel slides against external shock.
- Double Cover Protection to stop moisture and dirt from entering into the hand chain wheel case and the brake cover.
- Break Mechanism will activate instantly when operation is stopped, whether the load is light or heavy.
- Double Ratchet Pawls for extra safety. Should one pawl fail, the other restrains the load.
- Powder Metal Bushing to increase mechanical efficiency and reduce the hand chain pull strength.
- Load Chain Guide & Stripper to assure proper fit of load chain to load sheave. Also protects against dirt and moisture gathering in the load sheave.
- Slack End Anchorage that serves as a limit stopper to prevent any accidents caused by over-lowering heavy loads.
- Grade 80 Alloy Load Chain specially calibrated for hand chain block usage. All of the load chain meets or exceeds ISO and DIN standards.
- Hot forged, heat treated, swivel hooks with safety latches to ensure proper hooking to the load or sling.

PART#	STANDARD RATED W.L.L.	LIFT	HEADROOM	HANDLE EFFORT	TEST LOAD (TONS)	REPLACEMENT HOOKS TOP	REPLACEMENT HOOKS BOTTOM
80250	1/2 Ton	8.2'	10-3/4"	48 lb	3/4	80260-1	80260-2
80251	1 Ton	8.2'	11-3/4"	57 lb	1-1/2	80262-1	80262-2
80252	1-1/2 Ton	9.8'	14-3/4"	66 lb	2-1/4	80263-1	80263-2
80253	2 Ton	9.8'	14-3/4"	77 lb	3	80264-1	80264-2
80254	3 Ton	9.8'	20-3/4"	77 lb	4-1/2	---	---





REPLACEMENT WHEELS

Pneumatic Wheel

Rugged steel construction. Proof tested & certified. Use on straight or curved tracks. Adjustable to various beams. Axle bore is 5/8" (except **Part# 80117** which has an axle bore of 3/4").

PART#	TIRE SIZE	HUB WIDTH	WHEEL DIAMETER	TIRE WIDTH	RIM DIAMETER	HUB TYPE	TREAD PATTERN	LOAD RATING
80101	2.50-4	1.75"	8.5"	2.275"	4.8"	Offset	Lug	180 lb
80105	4.10/3.50-4	2.28"	10"	3.25"	4.9"	Offset	Saw-tooth	280 lb
80109	3.00-4	1.53"	10"	3"	4.8"	Offset	Diamond	260 lb
80113	5.00-6	3.15"	13"	4.45"	6.79"	Offset	Jag	390 lb
80116	4.80/4.00-8	6"	15.08"	3.66"	8.8"	Center	Smooth	390 lb
80117	4.80/4.00-8	6"	15.08"	3.66"	8.8"	Center	Smooth	390 lb

Flat Free Wheels

Axle bore size is 5/8". Steel rims. Tubeless. Comes with bearings and grease zerks.

PART#	TIRE SIZE	HUB WIDTH	WHEEL DIAMETER	TIRE WIDTH	RIM DIAMETER	HUB TYPE	TREAD PATTERN	LOAD RATING
80102	2.50-4	1.75"	8.5"	2.275"	4.8"	Offset	Lug	160 lb
80107	4.10/3.50-4	2.28"	10"	3.25"	4.9"	Offset	Jag	260 lb
80111	3.00-4	1.53"	10"	3"	4.8"	Offset	Diamond	240 lb
80112	3.00-4	2.59"	10"	3"	4.8"	Center	Diamond	240 lb
80115	5.00-6	3.15"	13"	4.45"	6.79"	Offset	Jag	370 lb
80118	4.80/4.00-8	6"	15"	3.66"	8.8"	Center	Smooth	370 lb

Semi-Pneumatic Wheel

Semi-pneumatic wheel with a durable plastic lightweight rim and hub. Axle bore size is 1/2".

PART#	TIRE SIZE	HUB WIDTH	WHEEL DIAMETER	TIRE WIDTH	RIM DIAMETER	HUB TYPE	TREAD PATTERN	LOAD RATING
80229	4.10/3.50-4	2.28"	10"	3.25"	4.67"	Offset	Jag	260 lb

Replacement Bearings For Wheels

PART#	AXLE BORE DIAMETER	OUTSIDE DIAMETER
80121	5/8"	1-15/32"
80122	1/2"	1-15/32"
80123	3/4"	1-15/32"

INDUSTRIAL CASTER WHEELS

For general use in hardware, factory and warehouse. Strong, durable, economical. Corrosion resistant zinc finish. Hard rubber wheels, black.

Caster Wheels With Rigid Top Plate

PART#	WHEEL DIAMETER	WHEEL WIDTH	OVERALL HEIGHT	AXLE SIZE	MOUNTING HOLE DIAMETER	LOAD RATING (LB)	PLATE SIZE (IN.)
31015	1-1/2"	7/8"	2"	1/4"	1/4"	77 lb	2-3/8" x 1-1/2"
31020	2"	1"	2-1/2"	1/4"	1/4"	110 lb	1-6/8" x 2-5/8"
31025	2-1/2"	1-1/8"	3-3/16"	5/16"	5/16"	165 lb	2-1/8" x 3-6/8"
31030	3"	1-1/4"	3-13/16"	3/8"	5/16"	210 lb	2-1/2" x 4"
31040	4"	1-5/16"	5"	7/16"	3/8"	240 lb	2-1/4" x 5"
31050	5"	1-1/4"	6-3/16"	3/8"	5/16"	220 lb	3-5/8" x 2-1/2"
31060	6"	2"	7-1/2"	15/32"	7/16"	660 lb	4-1/2" x 4"
31080	8"	2"	9-1/2"	15/32"	7/16"	700 lb	4-1/2" x 4"



Caster Swivel Wheels

PART#	WHEEL DIAMETER	WHEEL WIDTH	OVERALL HEIGHT	AXLE SIZE	MOUNTING HOLE DIAMETER	LOAD RATING (LB)	PLATE SIZE (IN.)
32015	1-1/2"	7/8"	2"	1/4"	1/4"	77 lb	2-3/8" x 1-3/4"
32020	2"	1"	2-1/2"	1/4"	1/4"	110 lb	1-7/8" x 2-9/16"
32025	2-1/2"	1-1/8"	3-3/16"	5/16"	5/16"	165 lb	2-3/4" x 3-13/16"
32030	3"	1-1/4"	3-13/16"	3/8"	5/16"	210 lb	3-1/8" x 4-1/8"
32040	4"	1-5/16"	5"	7/16"	3/8"	240 lb	4" x 5-1/8"
32050	5"	1-1/4"	6-3/16"	3/8"	5/16"	220 lb	3-5/8" x 2-1/2"
32060	6"	2"	7-1/2"	15/32"	7/16"	660 lb	4-1/2" x 4"
32080	8"	2"	9-1/2"	15/32"	7/16"	700 lb	4-1/2" x 4"



Caster Wheel With Side Locking Brake

PART#	WHEEL DIAMETER	WHEEL WIDTH	OVERALL HEIGHT	AXLE SIZE	MOUNTING HOLE DIAMETER	LOAD RATING (LB)	PLATE SIZE (IN.)
33015	1-1/2"	7/8"	2"	1/4"	1/4"	77 lb	2-3/8 x 1-3/4"
33020	2"	1"	2-1/2"	1/4"	1/4"	110 lb	1-7/8 x 2-9/16"
33025	2-1/2"	1-1/8"	3-3/16"	5/16"	5/16"	165 lb	2-3/4 x 3-13/16"
33030	3"	1-1/4"	3-13/16"	3/8"	5/16"	210 lb	3-1/8 x 4-1/8"
33040	4"	1-5/16"	5"	7/16"	3/8"	240 lb	4 x 5-1/8"
33050	5"	1-1/4"	6-3/16"	3/8"	5/16"	220 lb	3-5/8" x 2-1/2"
33060	6"	2"	7-1/2"	15/32"	7/16"	660 lb	4-1/2" x 4"
33080	8"	2"	9-1/2"	15/32"	7/16"	700 lb	4-1/2" x 4"





PNEUMATIC CASTER WHEELS

Caster Wheel With Rigid Top Plate

Rigid caster wheel with 4.10/3.50-4 pneumatic tube tire. 50 PSI, 4-ply sawtooth tread. 3-piece split 1.8mm rim with curled edges. 4" centered hub with valve stem and grease fitting on same side of rim. 1/2" precision ball bearing. Frame thickness is 5.5 mm.

PART#	WHEEL DIAMETER	WHEEL WIDTH	OVERALL HEIGHT	AXLE SIZE	MOUNTING HOLE DIAMETER	LOAD RATING (LB)	PLATE SIZE (IN.)
31100	10"	3-3/8"	12"	5/8"	7/16"	500 lb	4" x 4-1/2"



Caster Swivel Wheel

Swivel caster wheel with 4.10/3.50-4 pneumatic tube tire. Premium 50 PSI, 4-ply sawtooth tread. 3-piece split 1.8mm rim with curled edges. 4" centered hub with valve stem and grease fitting on same side of rim. 1/2" precision ball bearing. Frame thickness is 5.5 mm.

PART#	WHEEL DIAMETER	WHEEL WIDTH	OVERALL HEIGHT	AXLE SIZE	MOUNTING HOLE DIAMETER	LOAD RATING (LB)	PLATE SIZE (IN.)
31101	10"	3-3/8"	12"	5/8"	7/16"	500 lb	4" x 4-1/2"



FLAT FREE CASTER WHEELS

Caster Wheel With Rigid Top Plate

Rigid caster wheel with flat free tire. 1.8 mm rim, 1/2" ball bearing.

PART#	WHEEL DIAMETER	WHEEL WIDTH	OVERALL HEIGHT	AXLE SIZE	MOUNTING HOLE DIAMETER	LOAD RATING (LB)	PLATE SIZE (IN.)
31102	10"	3-3/8"	12"	5/8"	7/16"	360 lb	4" x 4-1/2"



Caster Swivel Wheel

Swivel caster wheel with flat free tire. 1.8 mm rim, 1/2" ball bearing.

PART#	WHEEL DIAMETER	WHEEL WIDTH	OVERALL HEIGHT	AXLE SIZE	MOUNTING HOLE DIAMETER	LOAD RATING (LB)	PLATE SIZE (IN.)
31103	10"	3-3/8"	12"	5/8"	7/16"	360 lb	4" x 4-1/2"

SMALL WHEEL RACK MERCHANDISER

PART#

CONTENTS

80103 1 Small Freestanding Wheel Rack, 21" wide x 72" high x 21" deep.

80103K

An assortment of pneumatic and flat free wheels on this space saving wheel rack. Rack is individually boxed, complete with hardware. All metal construction with black enamel painted finish. Includes: 10" x 3" Dynaline "Replacement Wheels" decal.



PART#

DESCRIPTION

QTY.

80101	Pneumatic Wheel - 8.5"-2.50 R4	2 ea.
80102	Flat Free Wheel - 8.5"-2.50 R4	2 ea.
80105	Pneumatic Hand Truck Wheel, 10.18"	2 ea.
80107	Flat Free Hand Truck Wheel, 10.18"	2 ea.
80109	Pneumatic Outdoor Hand Truck Wheel, 10.08"	2 ea.
80111	Flat Free Outdoor Hand Truck Wheel, 10.23"	2 ea.
80113	Pneumatic H.D. Hand Truck Wheel, 12.25"	2 ea.
80115	Flat Free H.D. Hand Truck Wheel, 13"	2 ea.
80116	Pneumatic Wheel Barrow Wheel, 15.08"	2 ea.
80118	Flat Free Wheel Barrow Wheel, 15.3"	2 ea.

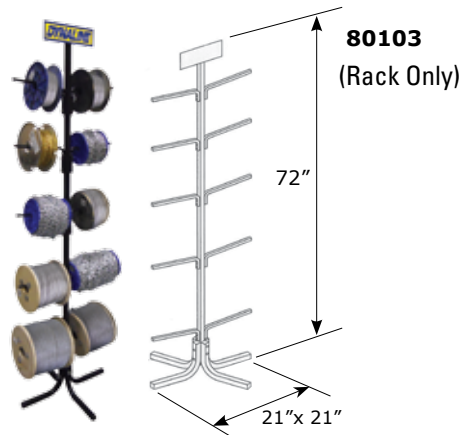

MACHINERY BUSHINGS - REFERENCE CHART

L

18 ga. 1.024 mm

M

14 ga. 1.628 mm

H

10 ga. 2.588 mm

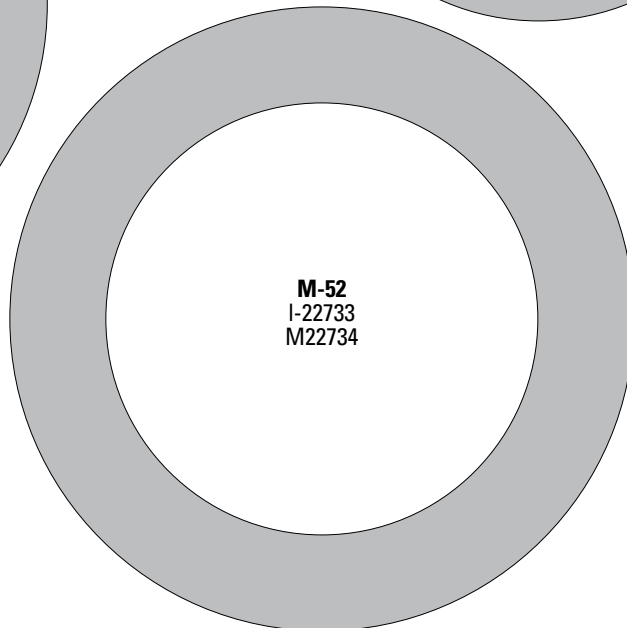
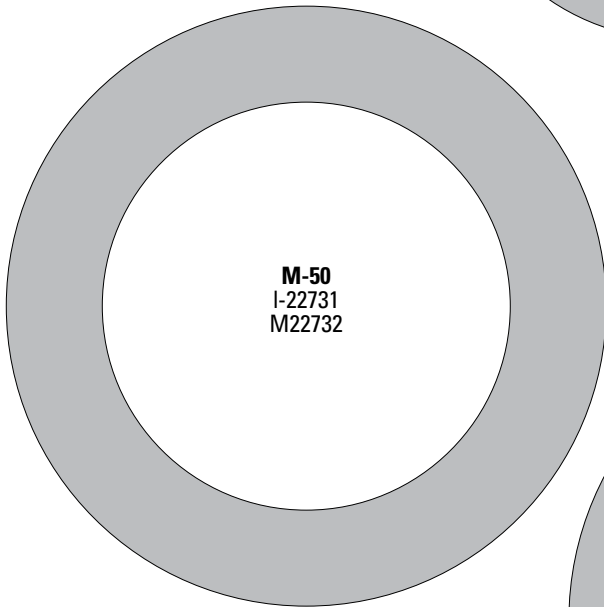
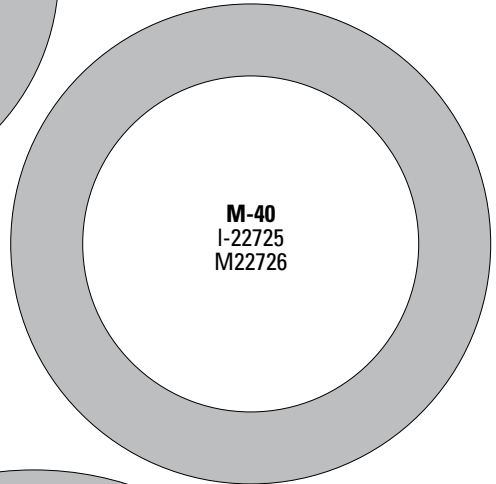
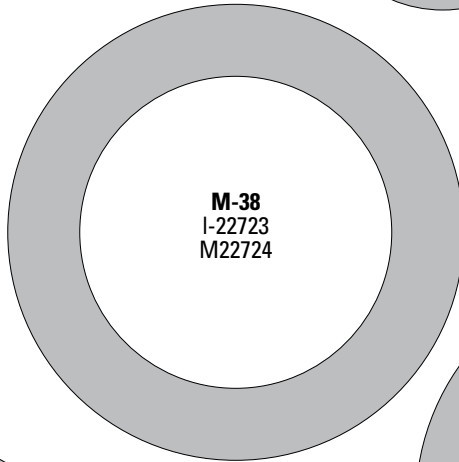
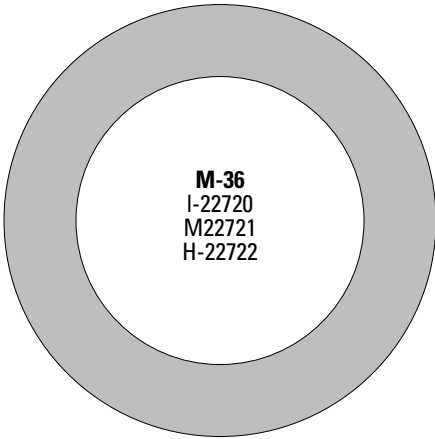
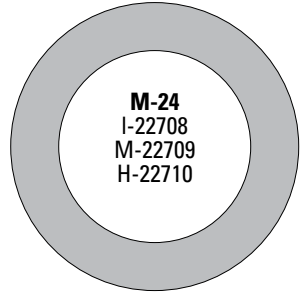
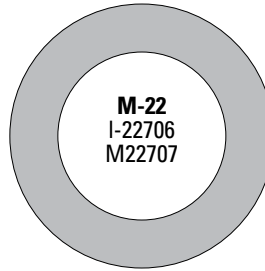
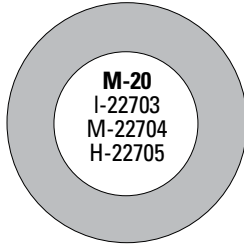
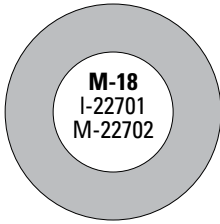
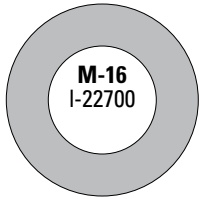

MACHINERY BUSHINGS - REFERENCE CHART

L

18 ga. 1.024 mm

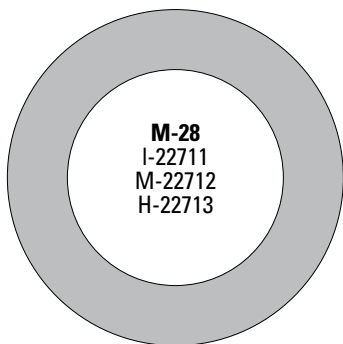

M

14 ga. 1.628 mm

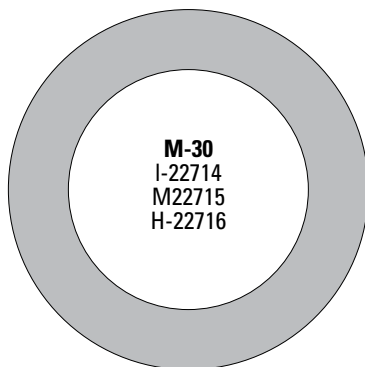

H

10 ga. 2.588 mm

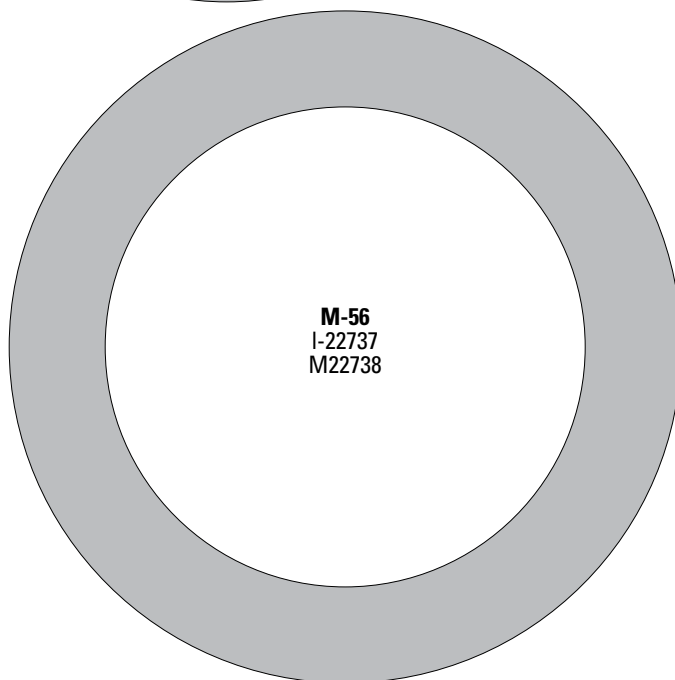
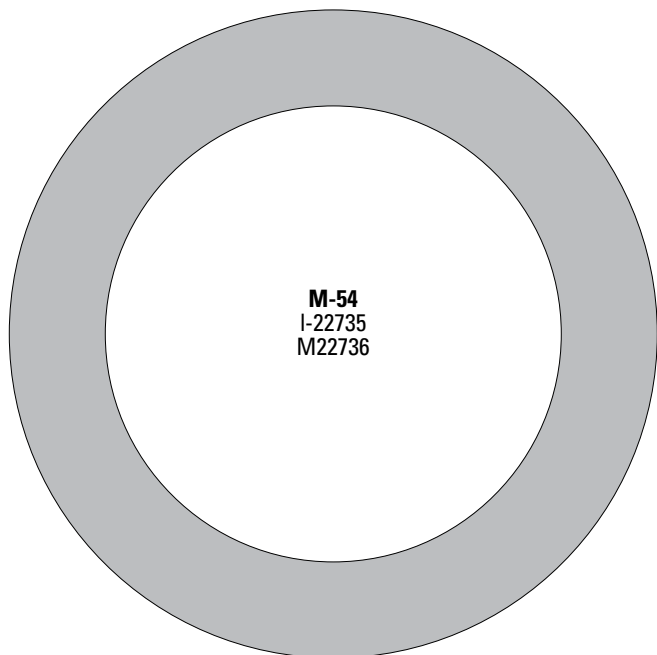
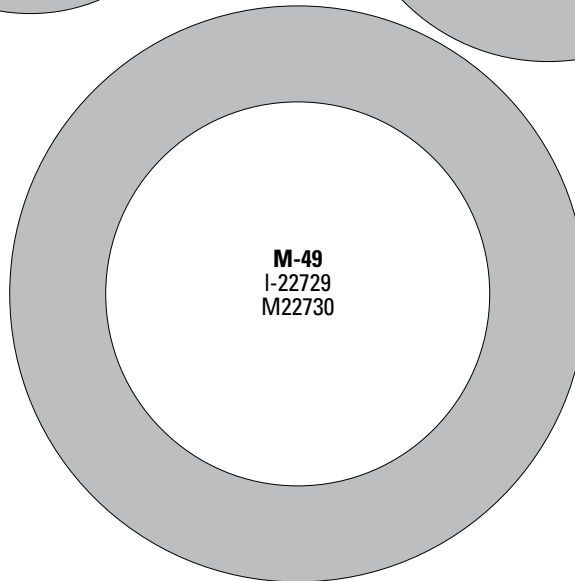
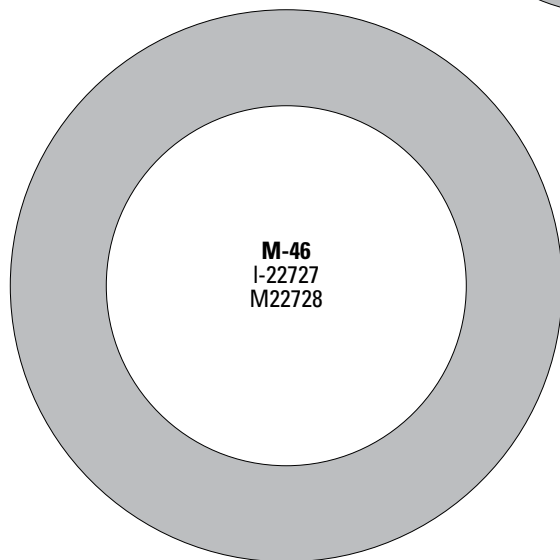
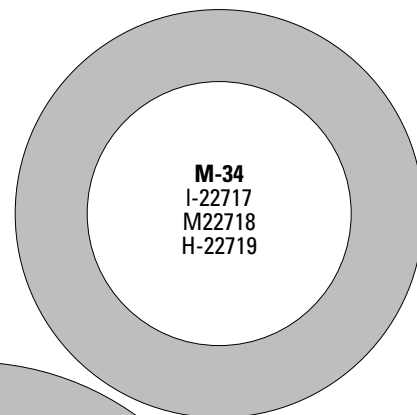

E RETAINER RINGS - REFERENCE CHART

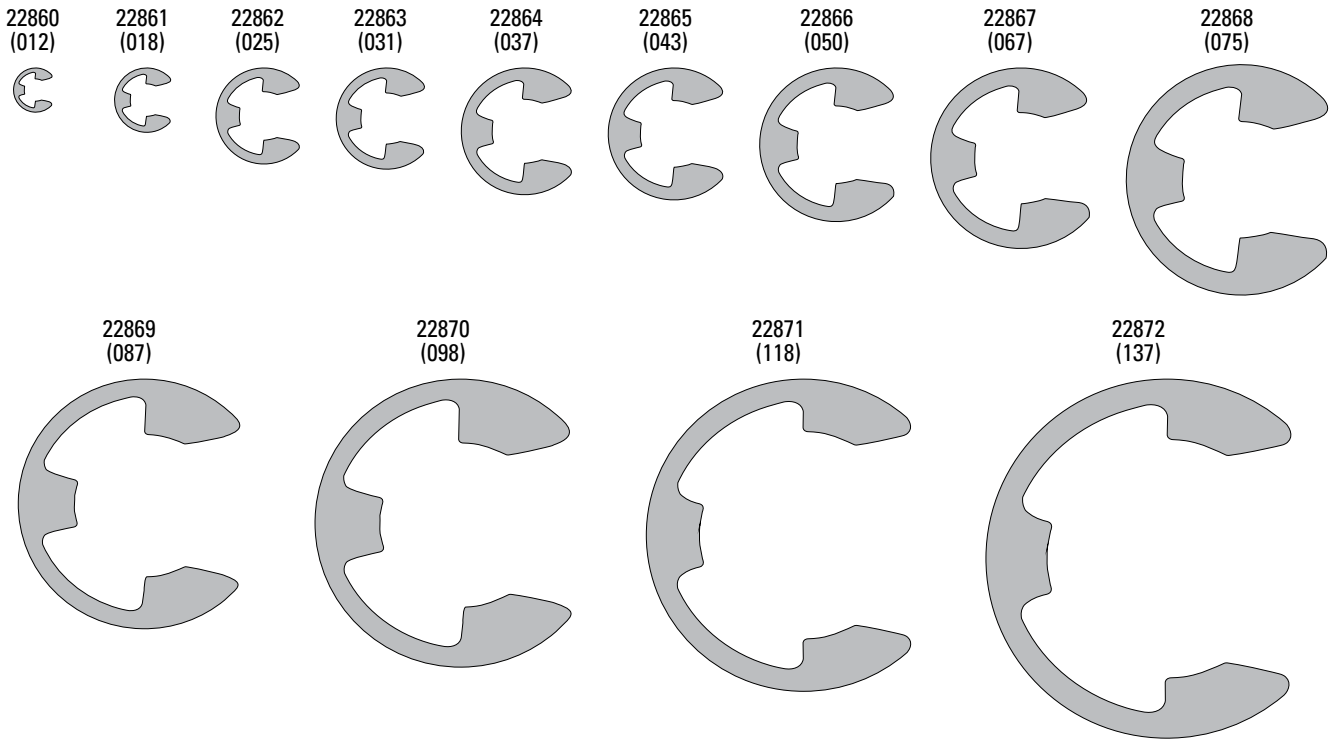

INTERNAL RETAINER RINGS - REFERENCE CHART

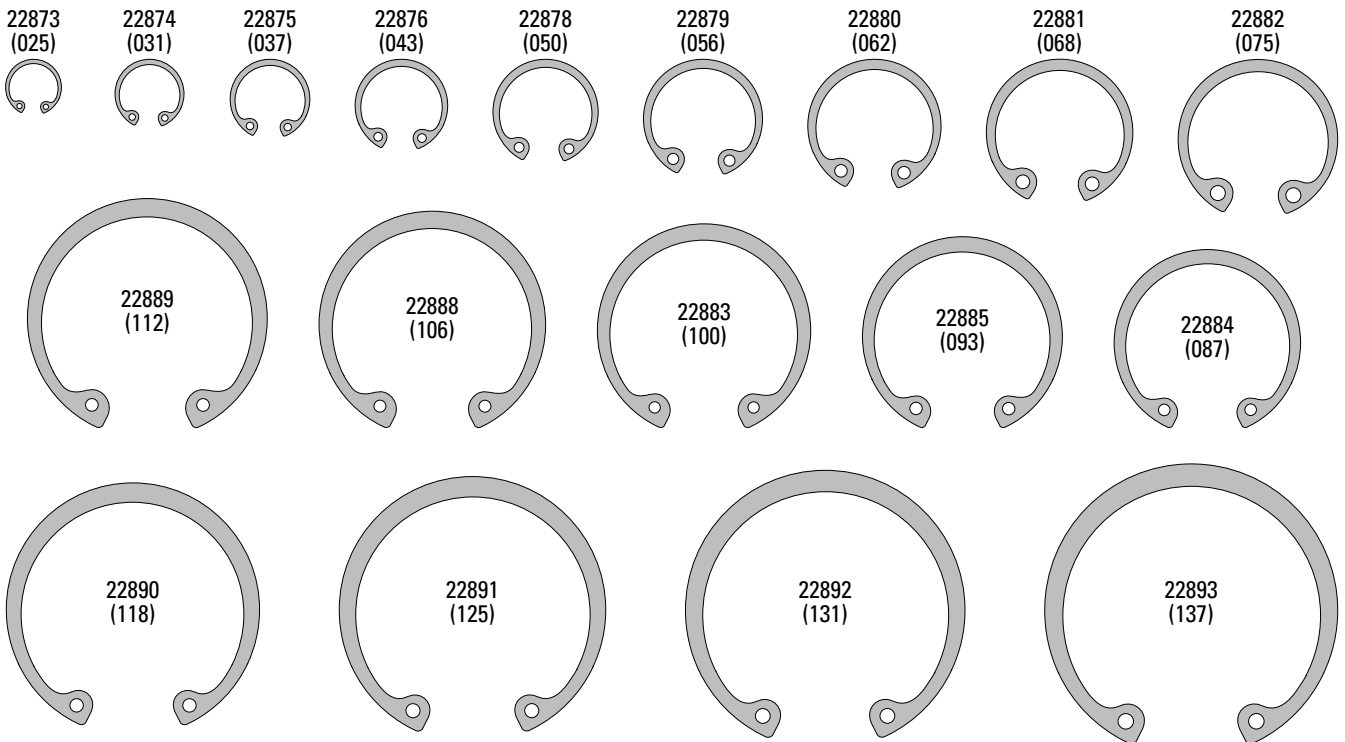

INTERNAL RETAINER RINGS - REFERENCE CHART

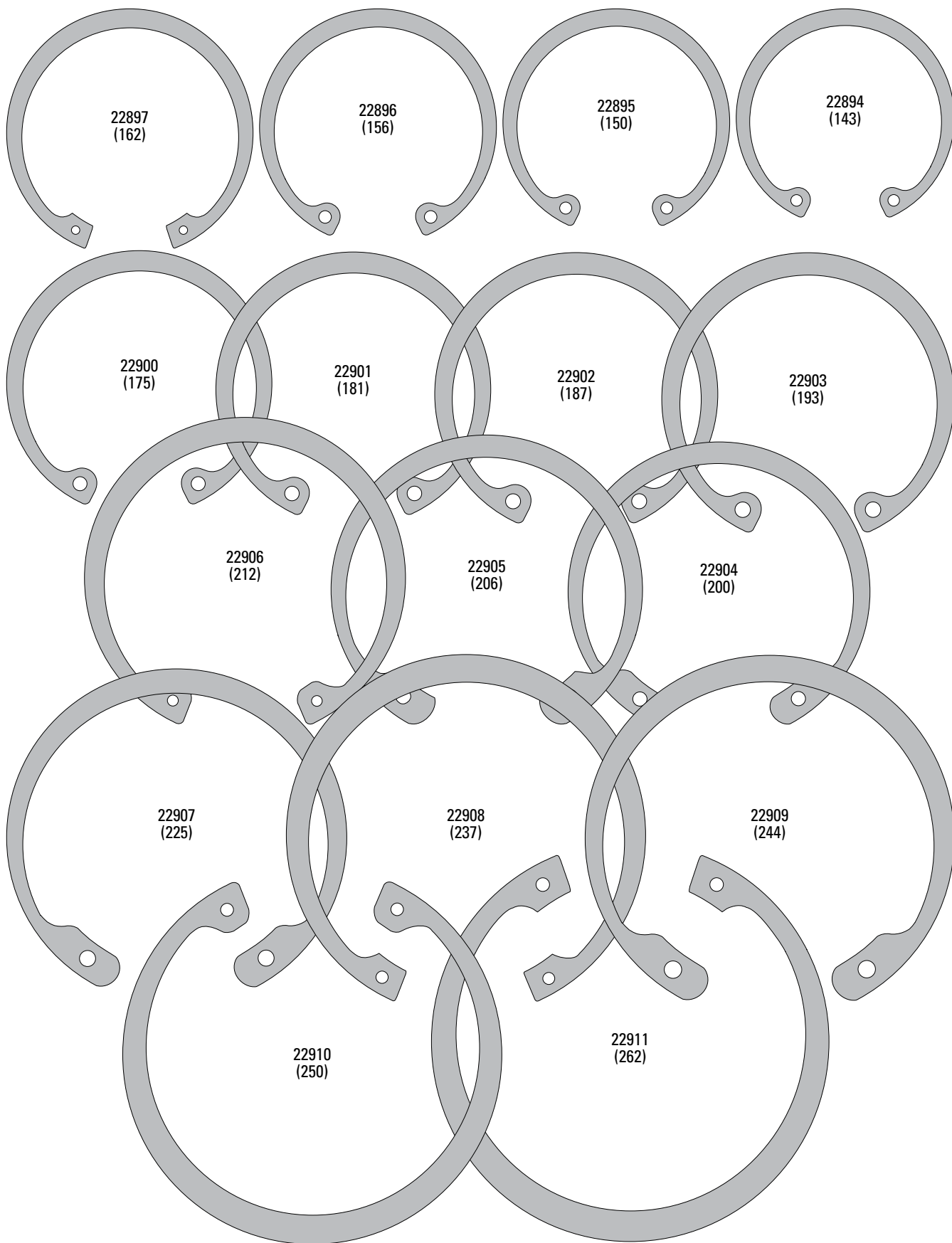

INTERNAL RETAINER RINGS - REFERENCE CHART

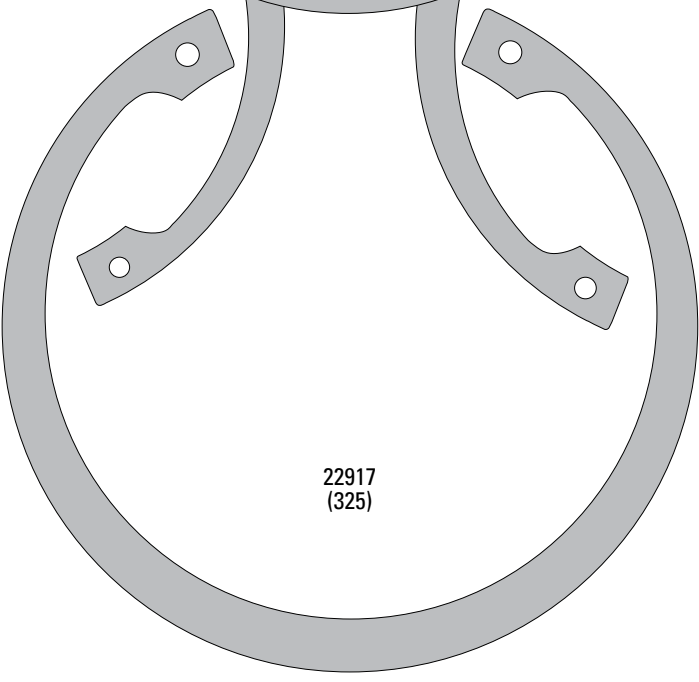
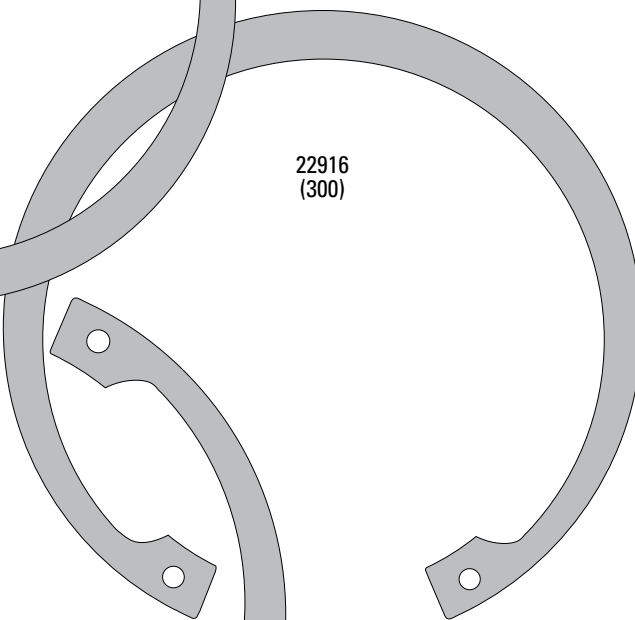
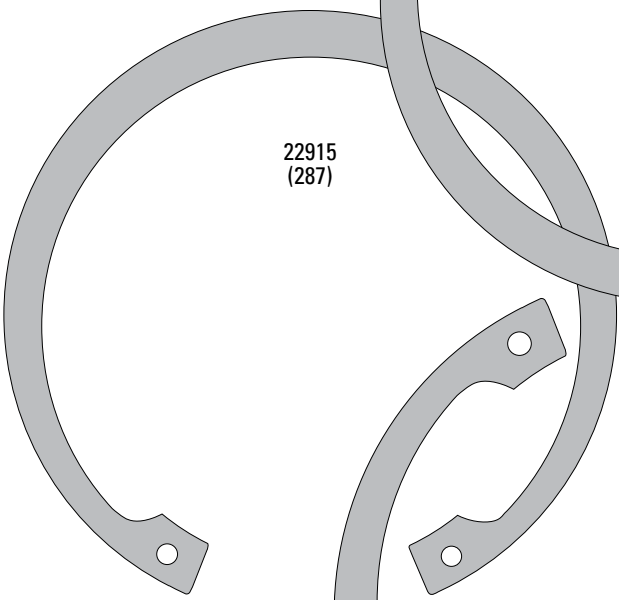
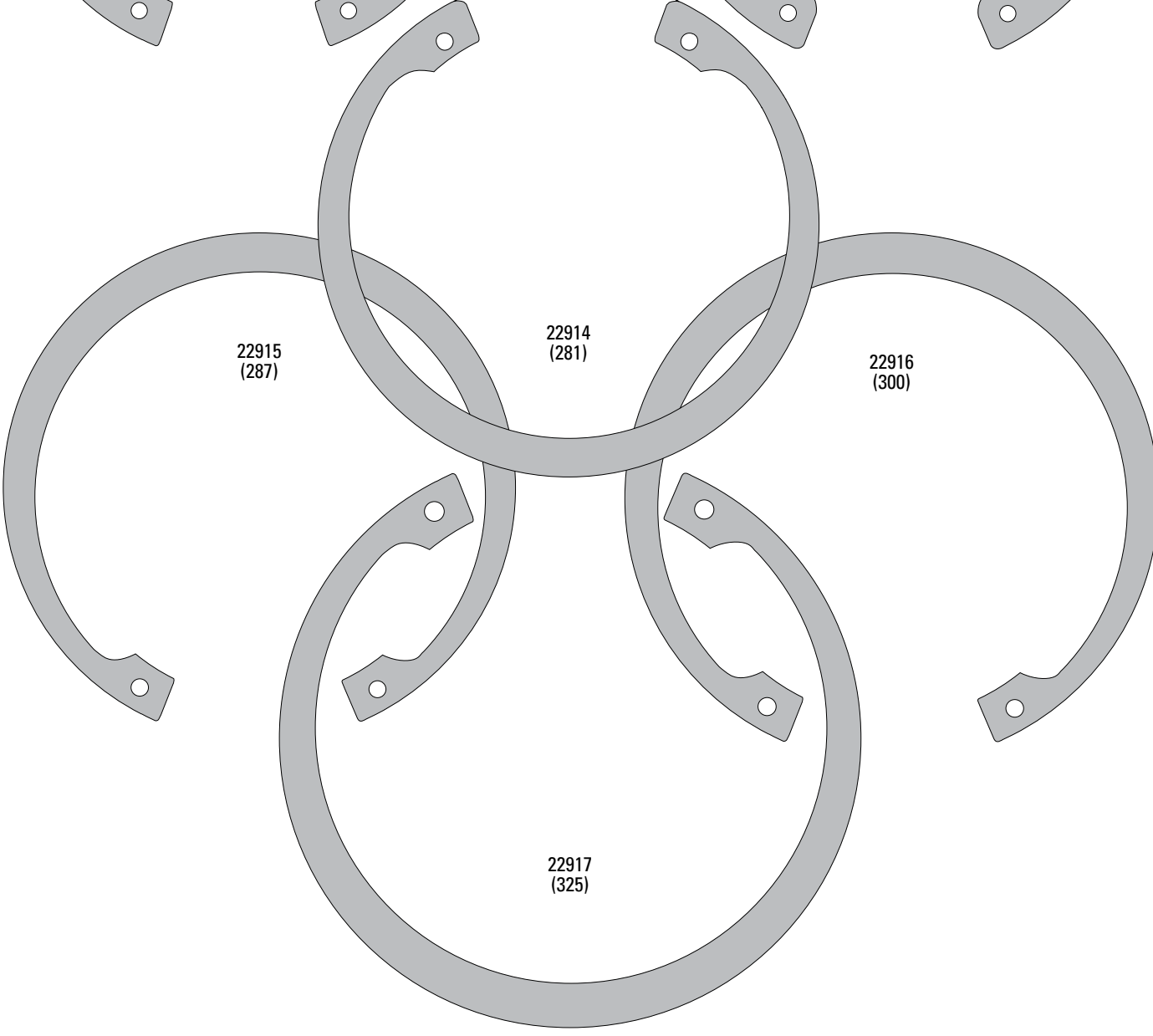
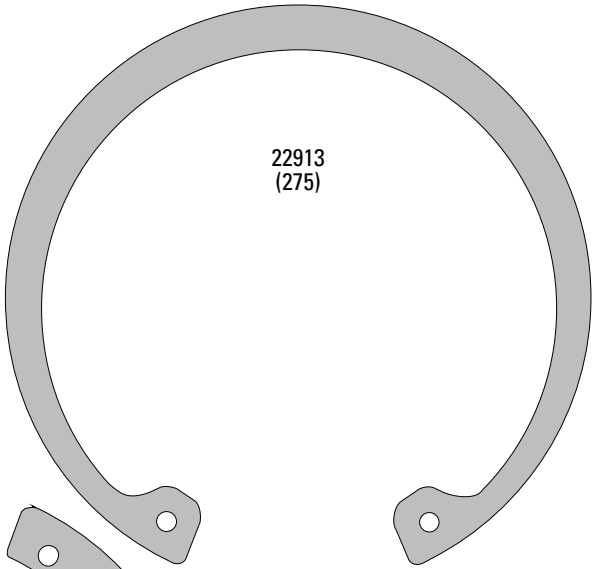
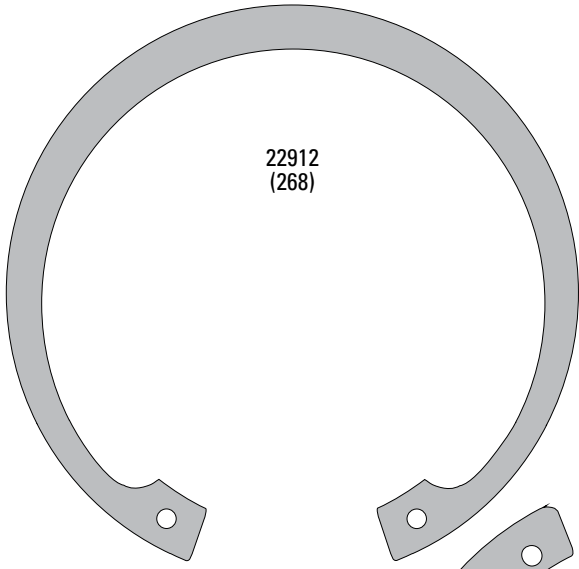

INTERNAL RETAINER RINGS - REFERENCE CHART

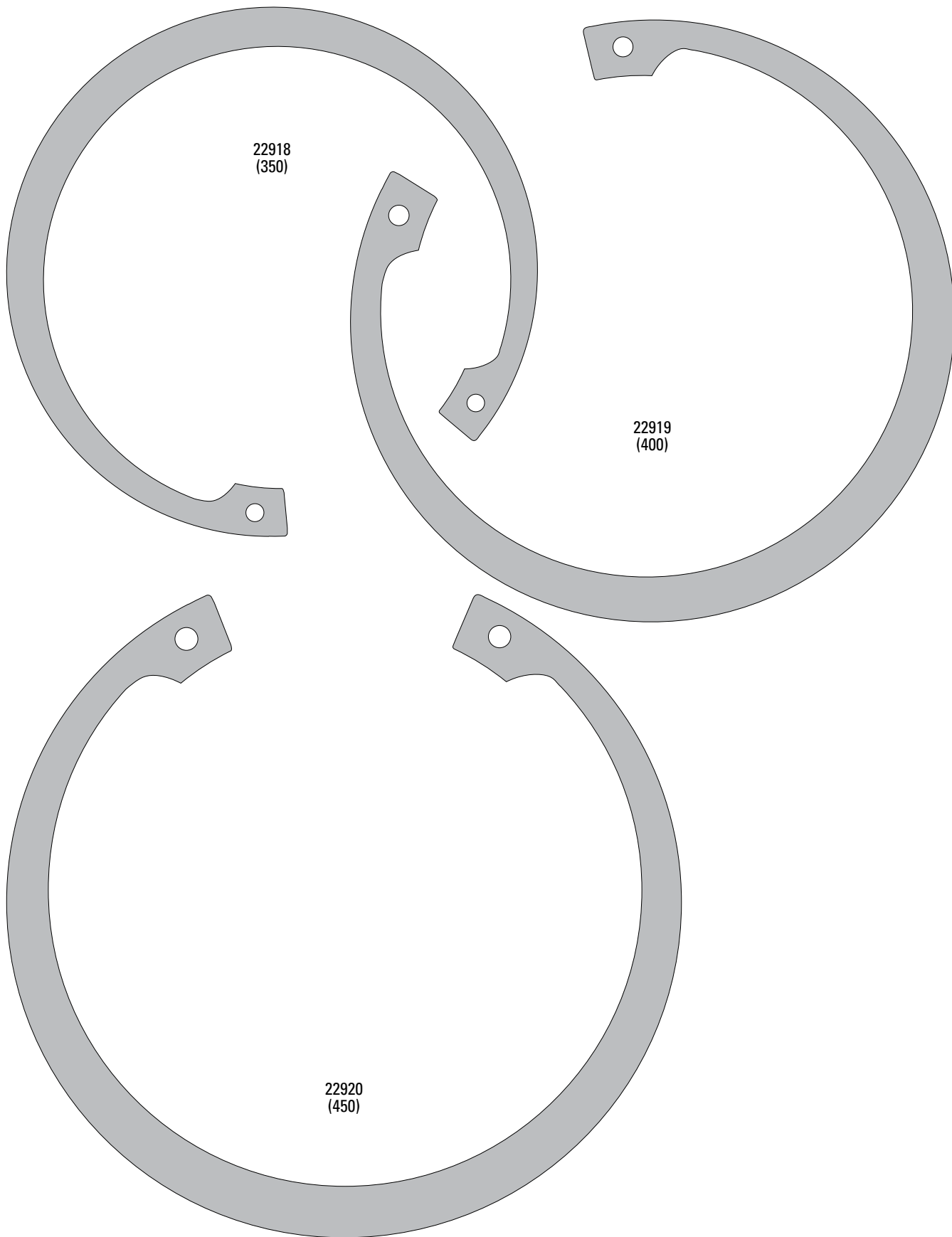

EXTERNAL RETAINER RINGS - REFERENCE CHART

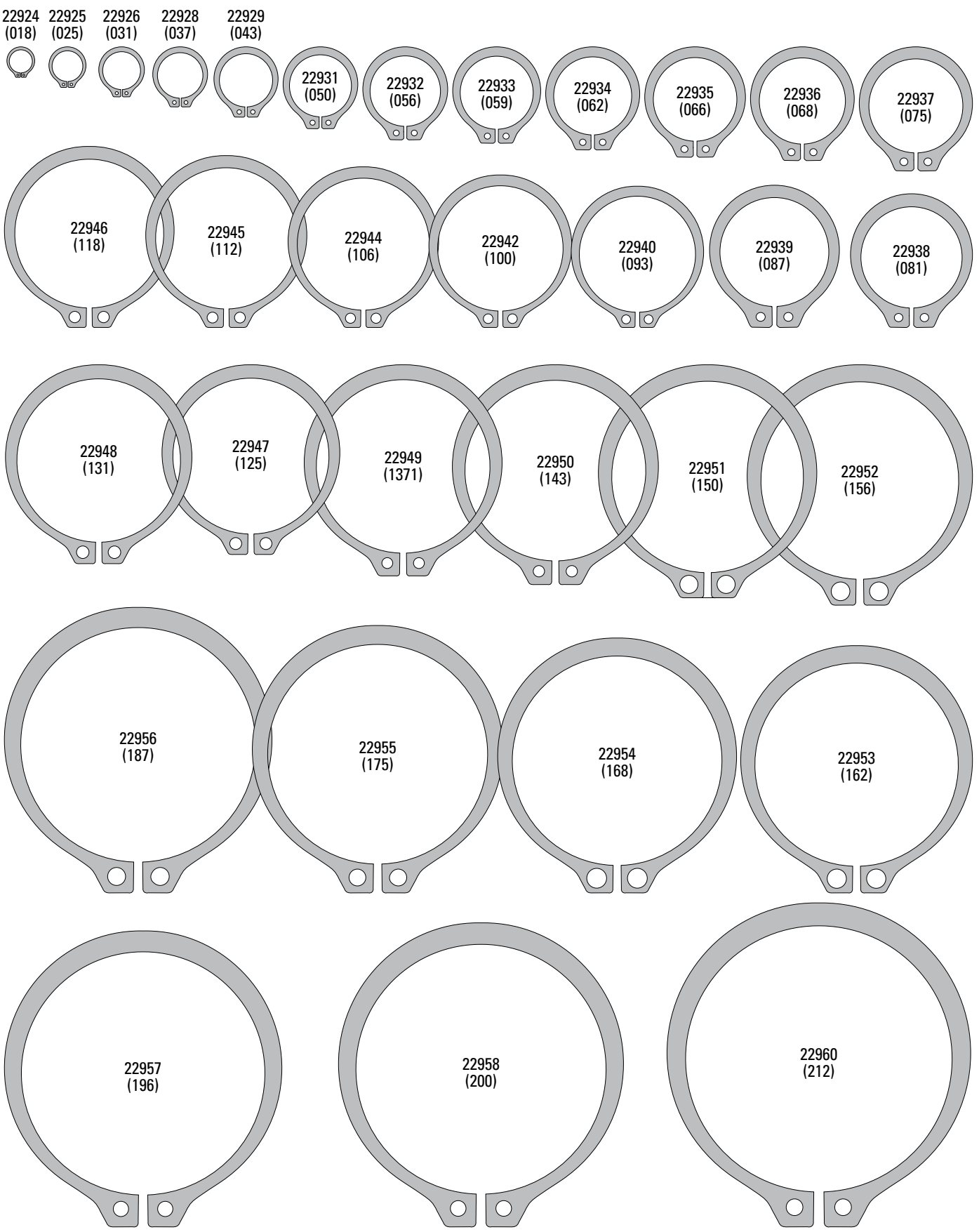

EXTERNAL RETAINER RINGS - REFERENCE CHART

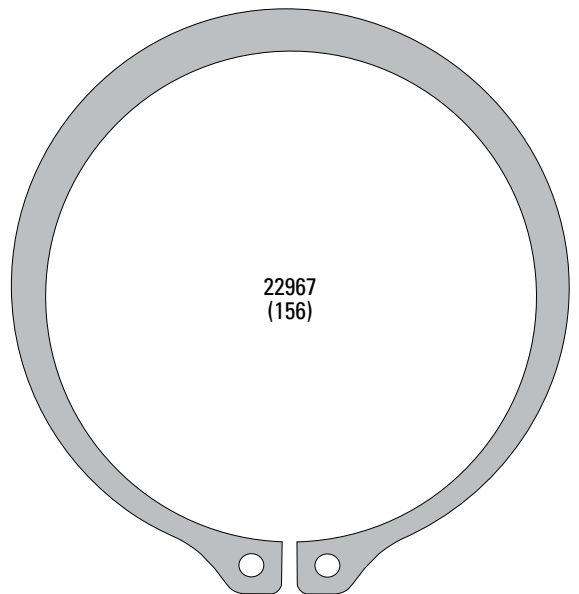
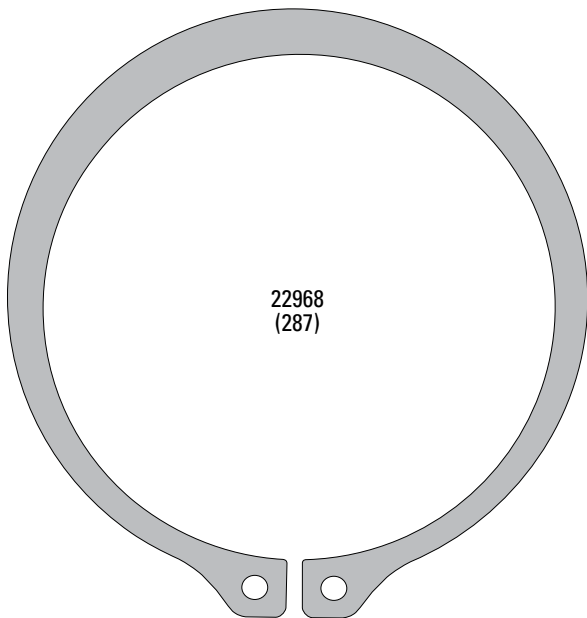
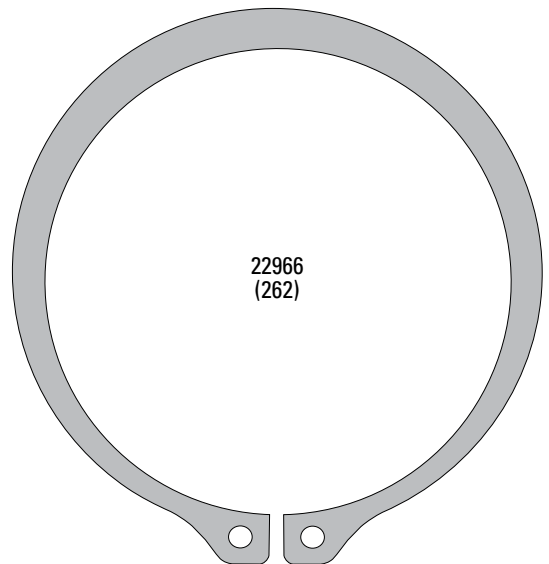
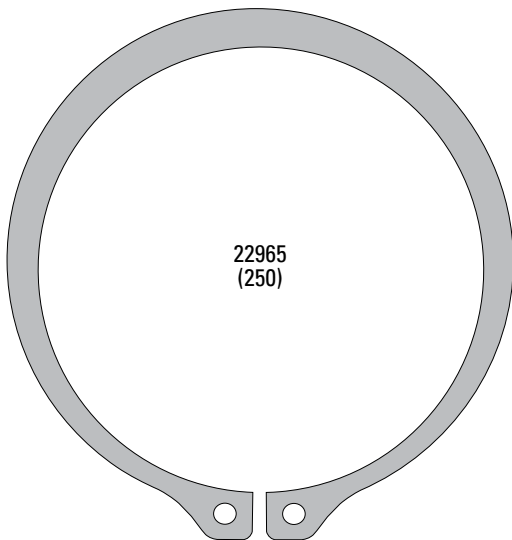
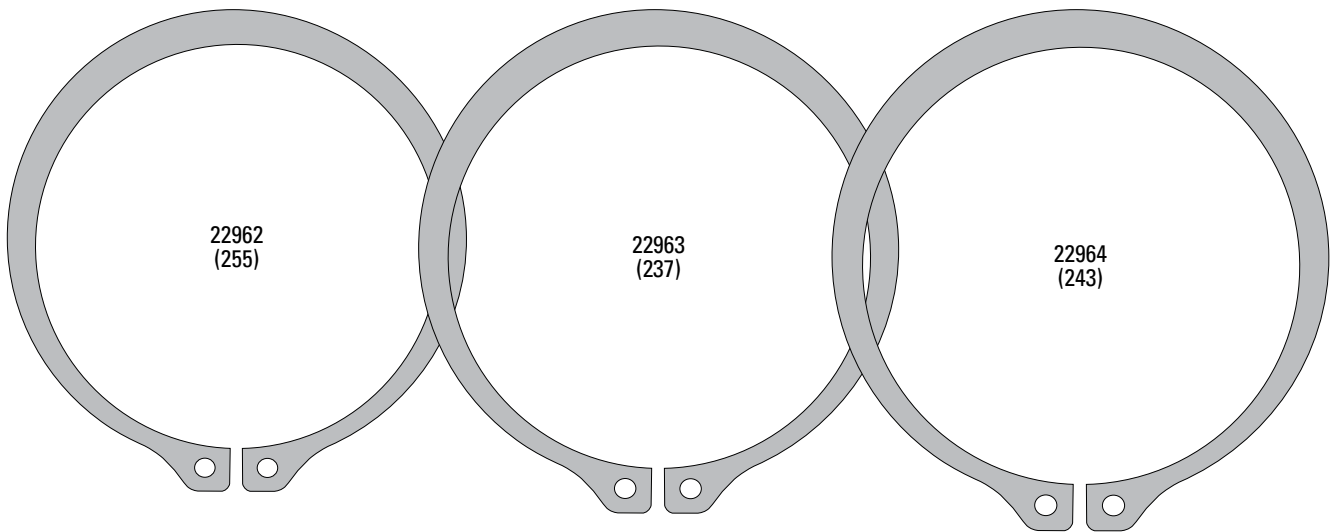

EXTERNAL RETAINER RINGS - REFERENCE CHART

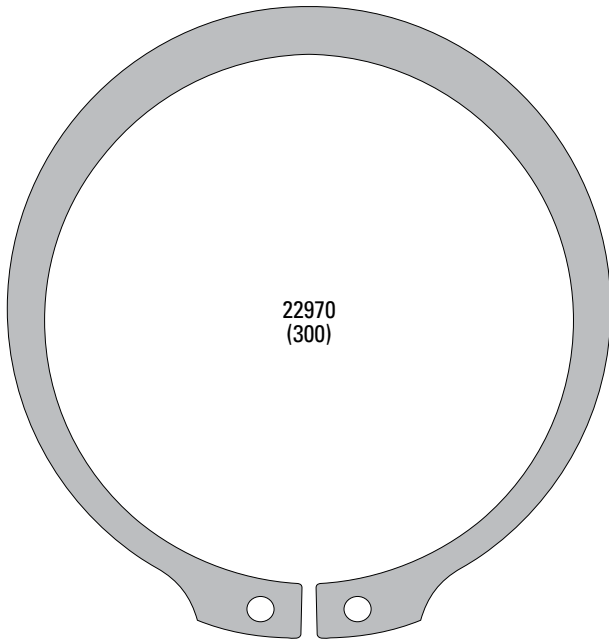

22970
(300)

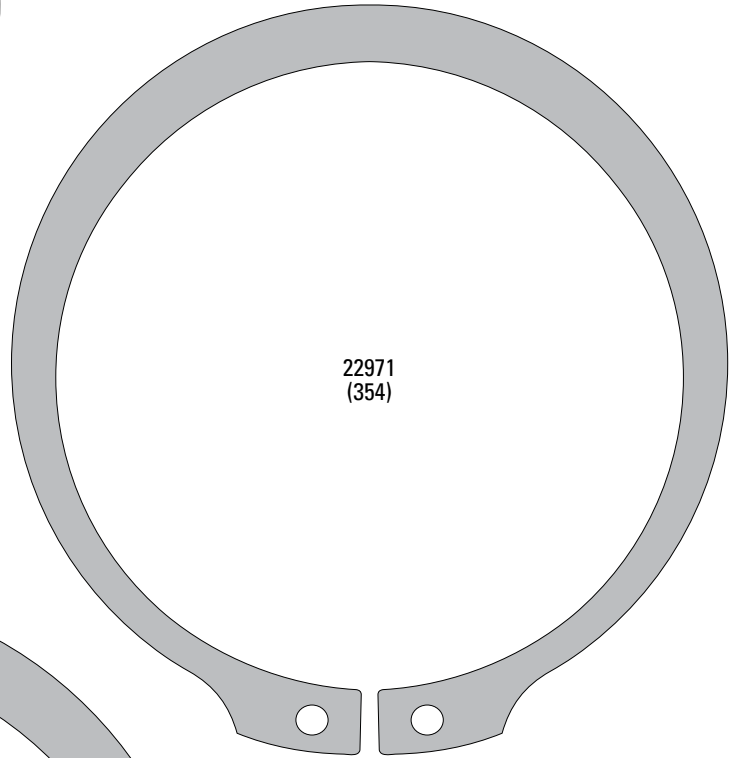

22971
(354)

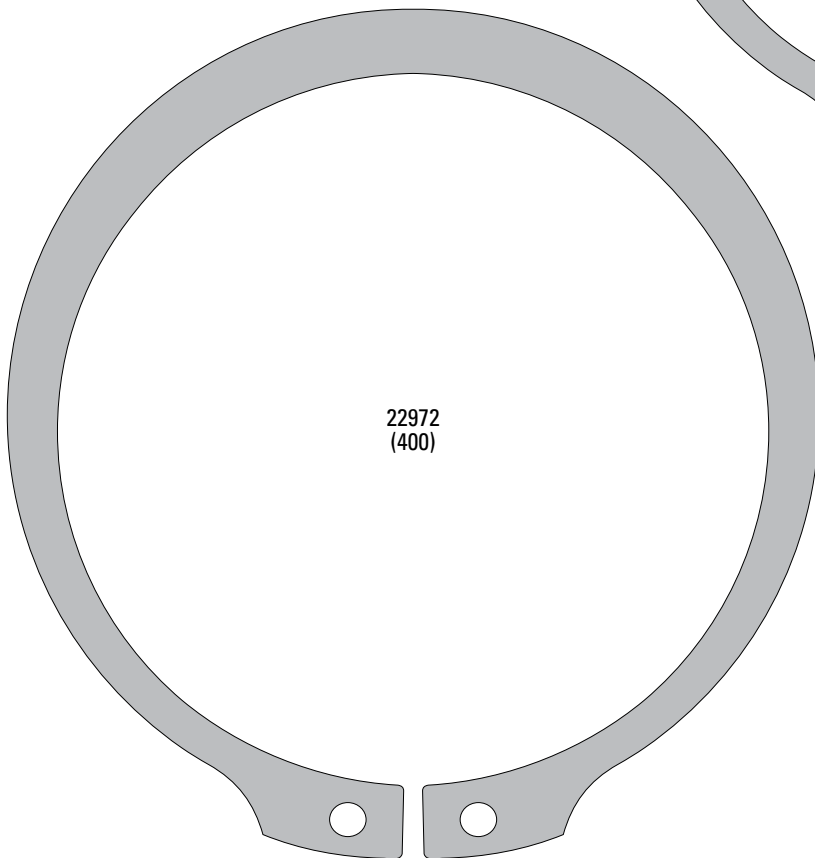

22972
(400)



Bits

Carpenter Pencils

Cobalt Drill Bits

Cutters

Driver Bits

LED Flashlights

Magnifiers

Padlocks

Saw Blades

Sets

Specialty Items

Tape Measures



TOOLS & ACCESSORIES



Trades professionals everywhere understand the value of owning BOSS tools.

Whether your trade of choice is in the agricultural, industrial or automotive after markets, BOSS has the quality and range of products to meet your most demanding needs.

Each tool is carefully designed and manufactured using superior materials and workmanship in order to ensure the highest performance and productivity standards as well as long service life.

When your livelihood depends on the tools that you use, BOSS is the brand of choice.

Table of Contents

Robertson Bits	1	Economy Cutters	12
Power Bits	2	Professional Cutters	14
Torx Bits.....	3	Blades	15
Hex/ Pozi/ Drywall Bits	4	LED Flashlights	16
Tamper Proof Bits	5	Padlocks.....	17
Nut Drives/ Socket Holders	6	Tape Measures	18
Adapters & Bit Holders	7	Drywall Saws	18
Driver Bit Sets	8	Magnifiers	19
Specialty Items	10	Carpenter Pencils.....	21
Cobalt Drill Bits.....	11	Saw Blades.....	21

ROBERTSON BITS - 5/PACK

Robertson bit features:

- 2 piece Robertson bits made of modified SL Japanese steel designed for 1/4" impact drivers
- Only genuine Robertson® colour coded 1/4" hex driver bits have "Cling Fit". Made with our genuine Robertson® Tip

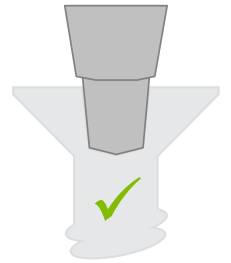
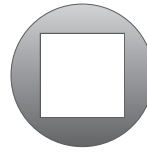

ROBERTSON® "CLING FIT"



Plain Finish - 2 Piece

Part#	Size	L	D
78100	#0	1"	1/4"
78101	#1	1"	1/4"
78102	#2	1"	1/4"
78103	#3	1"	1/4"
78120	#0	2"	1/4"
78121	#1	2"	1/4"
78122	#2	2"	1/4"
78123	#3	2"	1/4"
78A22*	#2	2"	1/4"
78130	#0	3"	1/4"
78131	#1	3"	1/4"
78132	#2	3"	1/4"
78133	#3	3"	1/4"
78134	#4	3"	1/4"
78141	#1	4"	1/4"
78142	#2	4"	1/4"
78143	#3	4"	1/4"
78151	#1	6"	1/4"
78152	#2	6"	1/4"
78153	#3	6"	1/4"
78181	#1	12"	1/4"
78182	#2	12"	1/4"
78183	#3	12"	1/4"

Colour Coded - 2 Piece

Part#	Colour	Size	L	D
72100	Yellow	#0	1"	1/4"
72101	Green	#1	1"	1/4"
72102	Red	#2	1"	1/4"
72103	Black	#3	1"	1/4"
72130	Yellow	#0	3"	1/4"
72131	Green	#1	3"	1/4"
72132	Red	#2	3"	1/4"
72133	Black	#3	3"	1/4"
72141	Yellow	#0	4"	1/4"
72142	Green	#1	4"	1/4"
72143	Red	#2	4"	1/4"
72151	Yellow	#0	6"	1/4"
72152	Green	#1	6"	1/4"
72153	Red	#2	6"	1/4"
72181	Yellow	#0	12"	1/4"
72182	Green	#1	12"	1/4"
72183	Red	#2	12"	1/4"



Magnetic Impact Bits - 1 Piece - Colour Sleeve

Part#	Colour	Size	L	D
75121	Green	#1	2"	1/4"
75122	Red	#2	2"	1/4"
75123	Black	#3	2"	1/4"
75131	Green	#1	3"	1/4"
75132	Red	#2	3"	1/4"
75133	Black	#3	3"	1/4"
75141	Green	#1	4"	1/4"
75142	Red	#2	4"	1/4"
75143	Black	#3	4"	1/4"
75151	Green	#1	6"	1/4"
75152	Red	#2	6"	1/4"
75153	Black	#3	6"	1/4"

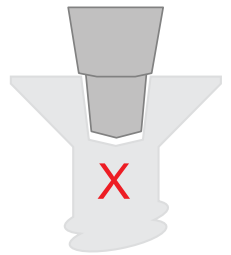

RECESS TOO LARGE

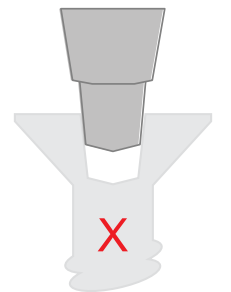

RECESS TOO NARROW

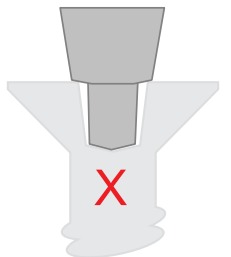

INCORRECT RECESS ANGLE



Robertson - Impact Branded

Part#	Colour	Size	L	D
74121	Green Band	#1	2"	1/4"
74122	Red Band	#2	2"	1/4"
74123	Black Band	#3	2"	1/4"

L= Length
D= Diameter

TOOLS & ACCESSORIES

POWER BITS

Power bit features:

- Quality controlled engineering for maximum torque
- 1/4" hex shaft fits ball retainer and regular style chucks
- 5 pieces per package

Phillips - Colour Coded

Part#	Colour	Size	L	D
72200	Yellow	#0	1"	1/4"
72201	Green	#1	1"	1/4"
72202	Red	#2	1"	1/4"
72203	Black	#3	1"	1/4"
72220	Yellow	#0	2"	1/4"
72221	Green	#1	2"	1/4"
72222	Red	#2	2"	1/4"
72223	Red	#2	4"	1/4"
72230	Yellow	#0	3"	1/4"
72231	Green	#1	3"	1/4"
72232	Red	#2	3"	1/4"
72233	Black	#3	3"	1/4"
72241	Green	#1	4"	1/4"
72242	Red	#2	4"	1/4"
72243	Black	#3	4"	1/4"
72251	Green	#1	6"	1/4"
72252	Red	#2	6"	1/4"
72253	Black	#3	6"	1/4"
72282	Red	#2	12"	1/4"



Slotted - Plain Finish

Part#	Size	L	D
78300	5/32"	1"	1/4"
78301	3/16"	1"	1/4"
78302	1/4"	1"	1/4"
78303	9/32"	1"	1/4"
78320	5/32"	2"	1/4"
78321	3/16"	2"	1/4"
78322	1/4"	2"	1/4"
78323	9/32"	2"	1/4"
78331	3/16"	3"	1/4"
78332	1/4"	3"	1/4"
78341	3/16"	4"	1/4"
78342	1/4"	4"	1/4"
78351	3/16"	6"	1/4"
78352	1/4"	6"	1/4"



Phillips - Plain Finish

Part#	Size	L	D
78200	#0	1"	1/4"
78201	#1	1"	1/4"
78202	#2	1"	1/4"
78203	#3	1"	1/4"
78210	#0	1-3/4"	1/4"
78211	#1	30mm	1/4"
78212	#2	30mm	1/4"
78213	#3	30mm	1/4"
78220	#0	2"	1/4"
78221	#1	2"	1/4"
78222	#2	2"	1/4"
78223	#3	2"	1/4"
78230	#0	3"	1/4"
78231	#1	3"	1/4"
78232	#2	3"	1/4"
78233	#3	3"	1/4"
78234	#4	3"	1/4"
78241	#1	4"	1/4"
78242	#2	4"	1/4"
78243	#3	4"	1/4"
78251	#1	6"	1/4"
78252	#2	6"	1/4"
78253	#3	6"	1/4"



L= Length
D= Diameter

TORX

 YOUR LOGO HERE

TORX bit features:

- Exact fit Torx tips for reduced cam out.
- Through Hardened for exceptional durability.
- 5 pieces per package

TORX- Plain Finish

Part#	Size	L	D
78400	T10	1"	1/4"
78401	T15	1"	1/4"
78402	T20	1"	1/4"
78403	T25	1"	1/4"
78404	T30	1"	1/4"
78405	T40	1"	1/4"
78406	T27	1"	1/4"
78417	T7	2"	1/4"
78418	T8	2"	1/4"
78419	T9	2"	1/4"
78420	T10	2"	1/4"
78421	T15	2"	1/4"
78422	T20	2"	1/4"
78423	T25	2"	1/4"
78424	T30	2"	1/4"
78425	T40	2"	1/4"
78426	T27	2"	1/4"
78427	T45	2"	1/4"
78428	T50	2"	1/4"
78429	T55	2"	1/4"
78430	T10	3"	1/4"
78431	T15	3"	1/4"
78432	T20	3"	1/4"
78433	T25	3"	1/4"
78434	T30	3"	1/4"
78435	T40	3"	1/4"
78436	T27	3"	1/4"



Custom Printing

- Speak to our sales team about custom labeling our products, with your branding.
- We can print on many unique items, giving your brand - name recognition in your industry.

CUSTOMIZABLE ITEMS



L= Length
D= Diameter

TOOLS & ACCESSORIES

HEX/POZI/DRYWALL BITS

Hex bit features:

- Ideal for automotive and machinery fasteners
- 1/4" hex shaft fits ball retainer and regular style chucks
- Chrome vanadium steel construction to withstand heavy use
- 5 pieces per package

Hex/Allen - Plain Finish

Part#	Size	L	D
78500	3/32"	1"	1/4"
78501	7/64"	1"	1/4"
78502	1/8"	1"	1/4"
78503	9/64"	1"	1/4"
78504	5/32"	1"	1/4"
78505	3/16"	1"	1/4"
78506	7/32"	1"	1/4"
78507	1/4"	1"	1/4"
78520	3/32"	2"	1/4"
78521	7/64"	2"	1/4"
78522	1/8"	2"	1/4"
78523	9/64"	2"	1/4"
78524	5/32"	2"	1/4"
78525	3/16"	2"	1/4"
78526	7/32"	2"	1/4"
78527	1/4"	2"	1/4"
78530	3/32"	3"	1/4"
78531	7/64"	3"	1/4"
78532	1/8"	3"	1/4"
78533	9/64"	3"	1/4"
78534	5/32"	3"	1/4"
78535	3/16"	3"	1/4"
78536	7/32"	3"	1/4"
78537	1/4"	3"	1/4"



Pozi bit features:

- Blunt tip for better seating
- Straight sides for additional torque

Pozi - Plain Finish

Part#	Size	L	D
78600	#0	1"	1/4"
78601	#1	1"	1/4"
78602	#2	1"	1/4"
78603	#3	1"	1/4"
78620	#0	2"	1/4"
78621	#1	2"	1/4"
78622	#2	2"	1/4"
78623	#3	2"	1/4"
78630	#0	3"	1/4"
78631	#1	3"	1/4"
78632	#2	3"	1/4"
78633	#3	3"	1/4"



Drywall

Part#	Size	L	D
72228	#2	1" Brass	1/4"
72229	#2	2" Brass	1/4"
*78205	#2	2"	1/4"
78228	#2	1"	1/4"
78229	#2	1"	1/4"
**80228	#2	1"	1/4"

* ACR **With Stopper



L= Length
D= Diameter

TAMPER PROOF BITS

Tamper proof bit features:

- Blunt tip for better seating
- Straight sides for additional torque
- 5 pieces per package

Torque - Plain Finish

Part#	Size	L	D
78450	T10	2"	1/4"
78451	T15	2"	1/4"
78452	T20	2"	1/4"
78453	T25	2"	1/4"
78454	T27	2"	1/4"
78455	T30	2"	1/4"
78456	T40	2"	1/4"



Hex - Plain Finish

Part#	Size	L	D
78551	3/32	2"	1/4"
78552	7/64	2"	1/4"
78553	1/8	2"	1/4"
78554	9/64	2"	1/4"
78555	5/32	2"	1/4"
78556	3/16	2"	1/4"
78557	7/32	2"	1/4"
78558	1/4	2"	1/4"



Clutch - Plain Finish

Part#	Size	L	D
78700	3/32"	1"	1/4"
78701	5/32"	1"	1/4"
78702	3/16"	1"	1/4"
78703	1/4"	1"	1/4"
78705	1/8"	1"	1/4"

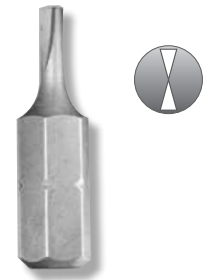

Spanner - Plain Finish

Part#	Size	L	D
78806	#6	2"	1/4"
78808	#8	2"	1/4"
78810	#10	2"	1/4"
78812	#12	2"	1/4"



Tri-Wing - Plain Finish

Part#	Size	L	D
78920	TRI-WING #0	2"	1/4"
78921	TRI-WING #1	2"	1/4"
78922	TRI-WING #2	2"	1/4"
78923	TRI-WING #3	2"	1/4"
78924	TRI-WING #4	2"	1/4"
78925	TRI-WING #5	2"	1/4"



L= Length
D= Diameter

TOOLS & ACCESSORIES

NUT DRIVES/SOCKET HOLDERS

Nut driver features:

- 1/4" hex shaft
- 5 pieces per package

Magnetic Nut Drivers - Colour Coded

Part#	Colour	Head	L	D
73110	Yellow	1/4"	2-1/2"	1/4"
73111	Green	5/16"	2-1/2"	1/4"
73112	Red	3/8"	2-1/2"	1/4"
73113	Brass	7/16"	2-1/2"	1/4"
73114	Black	1/2"	2-1/2"	1/4"
73115	Blue	9/16"	2-1/2"	1/4"



Deep Hole Nut Drivers - Colour Coded

Part#	Colour	Head	L	D
73210	Yellow	1/4"	2-1/2"	1/4"
73211	Green	5/16"	2-1/2"	1/4"
73212	Red	3/8"	2-1/2"	1/4"
73213	Brass	7/16"	2-1/2"	1/4"
73214	Black	1/2"	2-1/2"	1/4"



Deep Hole Nut Drivers - Plain Finish

Part#	Head	L	D
79210	1/4"	2-1/2"	1/4"
79211	5/16"	2-1/2"	1/4"
79212	3/8"	2-1/2"	1/4"
79213	7/16"	2-1/2"	1/4"
79214	1/2"	2-1/2"	1/4"



Magnetic Nut Drivers - Plain Finish

Part#	Head	L	D
79110	1/4"	2-1/2"	1/4"
79111	5/16"	2-1/2"	1/4"
79112	3/8"	2-1/2"	1/4"
79113	7/16"	2-1/2"	1/4"
79114	1/2"	2-1/2"	1/4"
79310	1/4"	6"	1/4"
79311	5/16"	6"	1/4"
79312	3/8"	6"	1/4"
79313	7/16"	6"	1/4"
79314	1/2"	2-1/2"	1/4"
79410	1/4"	1-3/4"	1/4"
79411	5/16"	1-3/4"	1/4"
79412	3/8"	1-3/4"	1/4"
79413	7/16"	1-3/4"	1/4"



Metric Magnetic Nut Drives - Plain Finish

Part#	Head	L	D
79707	#7	2-1/2"	1/4"
79708	#8	2-1/2"	1/4"
79709	#9	2-1/2"	1/4"
79710	#10	2-1/2"	1/4"
79712	#12	2-1/2"	1/4"
79715	#15	2-1/2"	1/4"
79717	#17	2-1/2"	1/4"



Socket Holders - Plain Finish

Part#	Head	L	D
79050	1/4"	1"	1/4"
79150	1/4"	2"	1/4"
79151	1/4"	3"	1/4"
79152	1/4"	4"	1/4"
79153	1/4"	6"	1/4"
79352	3/8"	2-9/16"	1/4"
79353	1/2"	2-3/4"	1/4"
79560	3/8"	2-9/16"	5/16"
79580	1/2"	2-9/16"	5/16"
79660	3/8"	2-9/16"	7/16"
79664	3/8"	4"	7/16"
79860	1/2"	2-9/16"	7/16"
79864	1/2"	4"	7/16"



L= Length
D= Diameter

ADAPTERS & BIT HOLDERS

Nut driver features:

- 1/4" hex shaft
- 5 pieces per package



Retractable Collar - Magnetic Rim

Part#	Type	Holder	L	D
79262	Magnet	1/4"	2-1/2"	1/4"



Quick Release - 6" Holder

Part#	Type	Holder	L	D
79284	Magnet	1/4"	6"	1/4"



Heavy Duty - Quick Change Adapter

Part#	Holder	L	D
79440	1/4"	2"	1/4"



Magnetic Bit Holders

Part#	Holder	L	D
79260	1/4"	2-1/2"	1/4"
79264	1/4"	4"	1/4"



Ceiling Bit Holder

Part#	Holder	L	D
79268	1/4"	2-1/2"	1/4"

L= Length
D= Diameter

TOOLS & ACCESSORIES

DRIVER BIT SETS

Driver bit features:

- 1/4" hex shaft
- Customizable packs available



711201 - Multi: Rob, Ph, Slotted 2" Pack

Part#	Description	Quantity
72120	Sq#0 x 2" 2pc Yellow	1
72121	Sq#1 x 2" 2pc Green	1
72122	Sq#2 x 2" 2pc Red	1
72123	Sq#3 x 2" 2pc Black	1
72220	Phillips #0 x 2" Yellow	1
72221	Phillips #1 x 2" Green	1
72222	Phillips #2 x 2" Red	1
72223	Phillips #3 x 2" Black	1
78321	S2 Slotted 3/16"x2"	1
78323	S2 Slotted 9/32"x2"	1



711221 - Rob2 x 2" Red Pack

Part#	Description	Quantity
72122	Sq#2 x 2" 2pc Red	10



711225 - Rob 2 x 2" Plain Pack

Part#	Description	Quantity
78122	S2 Sq#2 x 2"	10

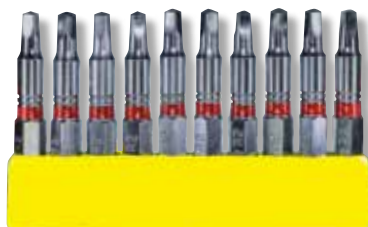

711269 - Impact x 2" Pack

Part#	Description	Quantity
74122	#2 x 2" Robertson Impact Bit Colored Band	10



711276 - Multi Rob & Ph 2 x 2" Pack

Part#	Description	Quantity
72121	Sq#1 x 2" 2pc Green	2
72122	Sq#2 x 2" 2pc Red	3
72123	Sq#3 x 2" 2pc Black	1
72221	Phillips #1 x 2" Green	1
72222	Phillips #2 x 2" Red	2
72223	Phillips #3 x 2" Black	1



777586 - Metric Mag Nut Drivers 2" Pack

Part#	Description	Quantity
79708	Metric Magnetic Nut Driver #8x 2.5" long	1
79709	Metric Magnetic Nut Driver #9x 2.5" long	1
79710	Metric Magnetic Nut Driver #10 x 2.5" long	1
79712	Metric Magnetic Nut Driver #12 x 2.5" Long	1
79715	Metric Magnetic Nut Driver 15mm x 65mm	1



717186 - Mag Nut Drivers 2-1/2" Pack

Part#	Description	Quantity
73110	Magnetic Nut Driver 1/4" x 2.5 Yellow	1
73111	Magnetic But Drive Green 5/16" x 2.5" long	1
73112	Magnetic Nut Driver 3/8" x 2.5 Red	1
73113	Brass Magnetic Nut Driver 7/16" x 2.5" long	1
73114	Magnetic Nut Driver 1/2" x 2.5 Black	1



DRIVER BIT SETS

Driver bit features:

- 1/4" hex shaft
- Custom branding available



- 18 Piece sets
- 2 Different bit configurations

721386 - Professional Assortment Bits and Nut Drive

Part#	Description	Quantity
72122	Sq#2 x 2" 2pc Red	2
72220	Ph#0 x 2" Yellow	1
72120	Sq#0 x 2" 2pc Yellow	1
72121	Sq#1 x 2" 2pc Green	1
72123	Sq#3 x 2" 2pc Black	1
72221	Ph#1 x 2" Green	1
72222	Ph#2 x 2" Red	2
72223	Ph#3 x 2" Black	1
73110	1/4" x 2.5" long Magnetic Nut Drive Yellow	1
73111	5/16" x 2.5" long Magnetic Nut Drive Green	1
73112	3/8" x 2.5" long Magnetic Nut Drive Red	1
73113	Brass Mag Nut Drive 7/16" x 2.5" long	1
73114	Black Mag Nut Drive 1/2" x 2.5" long	1
78321	S2 SL3/16"x2"	1
78323	S2 SL9/32"x2"	1
79260	Mag Insert Hold 1/4"x 60mm	1

721374 - 18 Piece With Impact Driver Bits

Part#	Description	Quantity
74121	#1 x 2" Robertson Impact Bit Col Band	1
74122	#2 x 2" Robertson Impact Bit Col Band	3
74123	#3 x 2" Robertson Impact Bit Col Band	1
72221	Ph#1 x 2" Green	1
72222	Ph#2 x 2" Red	2
72223	Ph#3 x 2" Black	1
78420	S2 TorqT10 x 2"	1
78421	S2 TorqT15 x 2"	1
78422	S2 TorqT20 x 2"	1
73110	1/4" x 2.5" long Magnetic Nut Drive Yellow	1



- 42 Piece sets
- 3 Different bit configurations

42 Piece Driver Bit Pack - Customizable Top

Part#	Description	Quantity
72120	Sq#0 x 2" 2pc Yellow	2
72121	Sq#1 x 2" 2pc Green	5
72122	Sq#2 x 2" 2pc Red	10
72123	Sq#3 x 2" 2pc Black	4
72220	Ph#0 x 2" Yellow	2
72221	Ph#1 x 2" Green	3
72222	Ph#2 x 2" Red	6

724240 - 42 Piece With Slotted Bits

Part#	Description	Quantity
72223	Ph#3 x 2" Black	3
78320	S2 SL5/32"x2"	1
78321	S2 SL3/16"x2"	1
78322	S2 SL1/4"x2"	2
78323	S2 SL9/32"x2"	1
72229	Brass Drywall #2 x 2"	2

724244 - 42 Piece With TORX Bits

Part#	Description	Quantity
72223	Ph#3 x 2" Black	5
78420	S2 TorqT10 x 2"	1
78421	S2 TorqT15 x 2"	1
78422	S2 TorqT20 x 2"	1
78423	S2 TorqT25 x 2"	1
78424	S2 TorqT30x2"	1

724248 - 42 Piece With Tamper Proof Bits

Part#	Description	Quantity
72223	Ph#3 x 2" Black	3
72229	Brass Drywall #2 x 2"	2
78451	Tamper Proof TorqT15x2"	1
78452	Tamper Proof TorqT20x2"	1
78453	Tamper Proof TorqT25x2"	1
78454	Tamper Proof TorqT27x2"	1
78455	Tamper Proof TorqT30x2"	1

TOOLS & ACCESSORIES

SPECIALTY ITEMS

Special features:

Packaged sets of top selling items.

Specialty tools.



Security Set

Part#	Description	Pack	Carton
771395	33 Piece Industrial S2 Steel Security Set	Carded	10



Magnetizer/Demagnetizer

Part#	Description	Pack	Box/Case
771400	Magnetizer/ Demagnetizer	Box	6/150



Damaged Screw Remover

Part#	Description	Pack	Box/Case
771410	3 Pack Ind. Screw Remover	Carded	12/48



9 Piece Allen Set Ball Point S2

Part#	Description	Pack	Box/Case
771500	9 Piece Ball Point Allen Set	Carded	6/36



Ratchet Set

Part#	Description	D	Pack
774440	16 Piece Ratchet Set	1/4"	6



3 Piece Socket Adapter Set

Part#	Description	Pack	Box/Case
793520	3 Piece Socket Adapter Set	Carded	25/100

COBALT DRILL BITS

WITH GRIZZLY TIP

Cobalt Drill Bits

Part#	Description	QTY/PKG	QTY/BOX
851000	1/16"	2	6
851002	5/64"	2	6
851004	3/32"	2	6
851006	7/64"	2	6
851008	1/8"	2	6
851010	9/64"	1	6
851012	5/32"	1	6
851014	11/64"	1	6
851016	3/16"	1	6
851018	13/64"	1	6
851020	7/32"	1	6
851022	15/64"	1	6
851024	1/4"	1	6
851026	17/64"	1	6
851028	9/32"	1	6
851030	19/64"	1	6
851032	5/16"	1	6
851034	21/64"	1	6
851036	11/32"	1	6
851038	23/64"	1	6
851040	3/8"	1	6
851042	25/64"	1	6
851044	13/32"	1	6
851046	27/64"	1	6
851048	7/16"	1	6
851050	29/64"	1	6
851052	15/32"	1	6
851054	31/64"	1	6
851056	1/2"	1	6



Grizzly Tip

Grizzly Tip™ is exclusively available from BOSS. It has excellent self centering characteristics. The center split point starts the cutting with the two sides (tips of the flutes) following close behind it providing 4 cutting edges. This increases the speed and smoothness of the drill and hole.

M35 is a high speed steel in the tungstenmolybdenum series with 5% cobalt added. The additional cobalt increase heat resistance. The carbides in it are small and evenly distributed. It has high wear resistance. After heat treatment, its hardness is the same as T1, but its bending strength can reach 4700 MPa. It's toughness and thermoplasticity are higher than T1 by 50%.

Skin Packaged



3 Ground Flat

The triangle shank is made by machining three flats on a round bar stock. It is intended as a minor modification of a straight shank, still allowing it to be held in a 3-jaw drill chuck, also allowing higher TORX transmission and limited slipping.

- Can be held in a drill chuck
- High TORX transmission
- Accurate centering



TOOLS & ACCESSORIES

ECONOMY CUTTERS



2560008



2560009



2550151

3/8" Blade Standard Duty

Part#	Pack#	Colour	Type	Sheath/ Lock	Blade/ Bl. Grade	Box/ Case
2550008	2560008	Yellow	Standard Cutter	Plastic / Thumb	3/8" / DIY	100 / 500
2550009	2560009	Blue	Mini Mite	Plastic / Auto	3/8" / DIY	60 / 120
2550151	2560151	Red	Hand Paper Cutter	Plastic / Touch	3/8" / DIY	60 / 120



2550488



2551802



2553208

Utility & Scraper

Part#	Pack#	Colour	Type	Sheath/ Lock	Blade/ Bl. Grade	Box/ Case
2550488	2560488	Black	Head Scraper	Plastic / Thumb	Utility / Contractor	60/120
2551802	2561802	Black	All Metal Utility	Metal / Thumb	Utility / Contractor	60/120
2553208	2563208	Yellow	Window Scraper	Plastic / Thumb	Single / DIY	60 / 120
2558208	2568208	Yellow	Econo Scraper	Plastic / Thumb	Single / DIY	60 / 120



2568208

3/4" Blade Extra Heavy Duty Plastic (Metal Reinforced)

Part#	Colour	Type	Sheath/ Lock	Blade/Bl. Grade	Box/ Case
2558066	Red	Metal Reinforced	Plastic / Thumb	3/4" / DIY	48 / 820
2558067	Yellow	Metal Reinforced	Plastic / Thumb	3/4" / DIY	48 / 480
2558068	Blue	Metal Reinforced	Plastic / Thumb	3/4" / DIY	48 / 480



3/4" Blade Standard Duty

Part#	Colour	Type	Sheath/ Lock	Blade/Bl. Grade	Box/ Case
2558129	Yellow	Economy	Plastic / Thumb	3/4" / DIY	60 / 120
2558130	Blue	Economy	Plastic / Thumb	3/4" / DIY	60 / 120



ECONOMY CUTTERS

3/4" Blade Heavy Duty

Part#	Colour	Type	Sheath/ Lock	Blade/Bl. Grade	Box/ Case
2558228	Red	#1 Seller	Plastic / Thumb	3/4" / DIY	48 / 480
2558229	Dark Green	#1 Seller	Plastic / Thumb	3/4" / DIY	48 / 480
2558230	Blue	#1 Seller	Plastic / Thumb	3/4" / DIY	48 / 480
2558231	Yellow	#1 Seller	Plastic / Thumb	3/4" / DIY	48 / 480
2558232	Orange	#1 Seller	Plastic / Thumb	3/4" / DIY	48 / 480
2558233	Light Green	#1 Seller	Plastic / Thumb	3/4" / DIY	48 / 480
2558234	Black	#1 Seller	Plastic / Thumb	3/4" / DIY	48 / 480



2558233

3/4" Blade Heavy Duty Plastic

Part#	Pack#	Colour	Type	Sheath/ Lock	Blade/ Bl. Grade	Box/ Case
2558806	N/A	Red	Thicker Plastic	Plastic / Thumb	3/4" / DIY	48 / 480
2558807	N/A	Yellow	Thicker Plastic	Plastic / Thumb	3/4" / DIY	48 / 480
2558808	N/A	Blue	Thicker Plastic	Plastic / Thumb	3/4" / DIY	48 / 480



2558806

PROFESSIONAL CUTTERS

3/8" Blade Standard Duty

Part#	Pack#	Sheath	Type	Box/Case
2550100	2560100	Standard Metal Cutter	3/8" Samuri Blade	60/240
2550200	2560200	Pocket Stainless Clip	3/8" Samuri Blade	60/240



2550200



548687



548688



2550425

3/4" Blade Heavy Duty

Part#	Pack#	Sheath/Lock	Box/Case
548687	568687	Ergo Grip Auto Lock/Double Locking	10/120
548688	568688	Ergo Grip Knob Lock/Oversized Knob	10/60
2550425	2560425	HD Plastic 2 Blade Storage/Knob Lock	10/100
546750	556750	Comfort Grip Knob Lock/Oversized Knob	10/120
546760	556760	Comfort Grip Auto Lock/Double Locking	10/100



546760



546750

TOOLS & ACCESSORIES

PROFESSIONAL CUTTERS



2552600



550460 SAFETY CUTTER



559110

Specialty Cutters

Part#	Pack#	Sheath/Lock	POP Display	Box/Case
2552600	2552600	Ergo Grip Serrated Blade/ Auto Lock	N/A	10/60
N/A	559110	Razor Aluminum Knife Utility Blade/ Folding	Box of 12	12/48
550460	N/A	Comfort Safety Cutter/ Metal Reinforced	N/A	12/24



546900



546920

1" Mega Blade Cutters

Part#	Pack#	Type	Sheath/Lock	Blade/Bl. Grade	Box/Case
546900	556900	Mega Cutter	Stainless/Knob	1" /Industrial	10/120
546920	556920	Mega Cutter	Stainless/Auto	1" /Industrial	10/120



2550406



2550430



550440

Auto Load Cutters

Part#	Pack#	Type	Sheath	Lock	Blade/Bl. Grade	Box/Case
2550406	2560406	Mega Cutter	Stainless	Knob	1" /Industrial	60/240
550440	N/A	Mega Cutter	Stainless	Auto	1" /Industrial	10/100
2550430	2560430	6 Blade Heavy Duty Knob Lock	Stainless	Knob	3/4"/Industrial	10/100
N/A	550470	5 Blade Auto Load Cutter	Stainless	Auto	3/4"/Industrial	10/100
N/A	550480	5 Blade Auto Load Mega Cutter	Stainless	Auto	1"/Industrial	10/100



550470



550480



BLADES

10 Pack: Part# 2555010 50 Pack: Part#2555050 Samuri Heavy Duty - 3/4" .5mm Thickness

- Sk2 + CH formulation means it stays sharper, longer
- Double honed edge for maximum sharpness
- 8 cutting edges.



Industrial Grade 3/4"

10 Pack: Part# 2554003 50 Pack: Part#2554033 Economy Blades DIY - 3/4" .5mm Thickness

- 8 cutting edges.



DIY Grade 3/4"

5 Pack: Part# 2554303 45 Pack: Part#2554333 Samuri Serrated Heavy Duty - 3/4" .6mm Thickness

- Sk2 + CH formulation means it stays sharper, longer
- Double honed edge for maximum sharpness
- 8 cutting edges.



Contractor Grade (Serrated) 3/4"

10 Pack: Part# 2554403 50 Pack: Part#2554433 Hi Carbon Heavy Duty - 3/4" .5mm Thickness

- SAE 1125 stress proff steel, honed
- 8 cutting edges.



Contractor Grade 3/4"

5 Pack: Part# 2555403 20 Pack: Part#2555423 Samuri Mega Heavy Duty - 1" .7mm Thickness

- Sk2 + CH formulation means it stays sharper, longer
- Double honed edge for maximum sharpness
- 8 cutting edges.



Industrial Grade 1"



10 Pack: Part# 2554405 100 Pack: Part # 2554415

- 2 Notch utility blades - .6mm

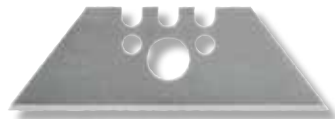

10 Pack: Part# 2554406 100 Pack: Part# 2554416

- 3 Notch utility blades - .5mm



10 Pack: Part# 2554407 for Safety Cutter 550460

- 2 Notch utility blades - .6mm



10 Pack: Part# 2554402

- 2 Notch utility blades - .5mm

TOOLS & ACCESSORIES

LED FLASHLIGHTS



231333



Nichia LED Professional Penlight

Part#	Description	Pack
231333	Mechanics LED Single Nichia Diode 3 x AAAA. Push or twist switch. Water resistant.	12/ Display Box



234439



Cree LED 3W Focusing Light

Part#	Description	Pack
234439	3 W 3 x AAA Super Brite Cree LED. CREE Diode, push button , anodized aircraft aluminium body.	8/Display Box



234440



8 LED with Laser Pointer

Part#	Description	Pack
234440	8 LED with Laser Pointer 3 x AAA. Functions LED, laser and LED with laser.	8/Display Box



204337



LED Job Box

Part#	Description	Pack
204337	2 x AA batteries included, push or twist cap , water resistant.	12/Jar

PADLOCKS

Padlocks

Part#	Lock x Shackle (mm)	Type	Pack
2251525	25" x 14"	KD	1
2251526	25" x 14"	KA	2
2251530	30" x 20"	KD	1
2251531	30" x 20"	KA	2
2251540	40" x 23"	KD	1
2251541	40" x 23"	KA	2
2251550	50" x 30"	KD	1
2251551	50" x 30"	KA	2
2251560	60" x 33"	KD	1
2251561	60" x 33"	KA	2
2251740	40" x 63"	KD	1
2251741	40" x 63"	KA	2
2251840	40" x 100"	KD	1
2251841	40" x 100"	KA	2
2251850	50" x 75"	KD	1
2251851	50" x 75"	KA	2

Padlock features:

- Double locking mechanism
- Hardened steel shackle, chrome plated
- Stainless steel & hardened spring for any climate
- Solid brass case
- Anti-pick mushroom pins



KD = Keyed Different
KA = Keyed A-Like

Combination Padlock - 1/Package



Part#	Description
2253554	50mm Hardened steel shackle

Waterproof Padlocks - 1/Package

Part#	Description
2253540	40mm Standard Shackle
2253541	40mm Long Shackle



Dimensions

PART #	SIZE	A	B	C	D	E	F	LOCKING	PINS
2251520	20mm	20	20	11.9	3.5	9.7	9.3	Single	3
2251525	25mm	25	24.5	14.1	4	12.7	11.9	Single	4
2251530	30mm	30	27.5	17.5	4.8	15.9	12.8	Double	4
2251540	40mm	40	33	23	6.35	21.6	14.5	Double	5
2251550	50mm	50	40.4	29	7.9	27.5	16.8	Double	5
2251560	60mm	60	45.4	32.9	9.5	35.8	19.1	Double	5
2251570	70mm	70	48.2	33.6	11.8	37.9	20.8	Double	6
2251730	30x65mm	30	27.5	65	4.8	15.9	12.8	Double	4
2251740	40x63mm	40	33	63	6.35	21.6	14.6	Double	4
2251840	40x100mm	40	33	100	6.35	21.6	14.6	Double	4
2251850	50x100mm	50	40.4	75	7.9	27.5	16.8	Double	5

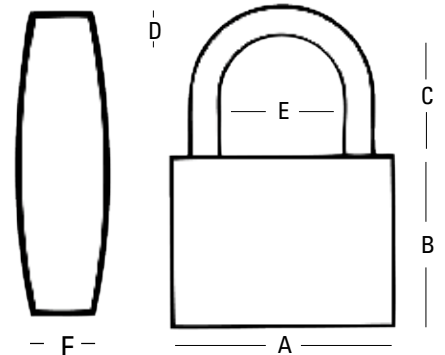

Blank Keys: 20mm: 2550520 • 25mm: 2550525 • 30mm: 2550530 • 40mm - 2550540 • 50mm: 2550550 • 60mm: 2550560 • 70mm: 2550570

TOOLS & ACCESSORIES

TAPE MEASURES

Utility Grade - with quality:



- Coated: Nylon coated blade for maximum weather protection
- Armor housing
- Rivets: 3 end rivets
- Stops: Two well positioned stops for easy use

Utility Grade - 6/Box

Part#	Length	Graduation	Width	Hook
38210	25'/7.5m	Imperial/Metric Combo	1"	Standard
38220	25'	Imperial	1"	Standard

Quality - without the huge price:



- Coated: Nylon coated blade for maximum weather protection
- Armor: Coated with rubber for comfort and drop protection
- Rivets: 4 end rivets for extended life
- Stops: Two well positioned stops for easy use
- Heavy Duty Blade: 30% thicker blade for long reach & durability. Tough, fast retracting spring system



Quality Grade - 12/Box

Part#	Length	Graduation	Width	Hook
38316	16'/5m	Imperial/Metric	1"	Standard
38325	16'/7.5m	Imperial/Metric	1"	Standard
38425	25'	Imperial	1"	Standard
38475	25'	Imperial/Double Sided	1"	Magnetic*
38450	25'/7.5m	Imperial/Metric	1"	Standard

*Grab Hold: Magnetic double hooked for easy measuring

DRYWALL SAWS



Drywall Saws

Part#	Type	Box/Case
B54135	Tri-tooth with holster	12/48
B54124	Double edge teeth	12/48

MAGNIFIERS

Magnifier features:

- Small and portable.
- Useful in many different situations, but do require that the user be able to hold the magnifier steady.

Illuminated Magnifiers

Part#	Description
2807550	Mag 4.5X Lens 50mm Requires 2AA batteries (not included)
2807590	Mag 2.5X Lens 90mm Requires 4AA batteries (not included)



2807550

Retractable Magnifiers

Part#	Description
2808237	Mag 2X Lens 34mm x 56mm Requires 2AA batteries (not included)
2808768	Mag 5X Lens 36mm x 40mm Requires 2AA batteries (not included)



2808237

Folding Magnifiers

Part#	Description
2808550	Mag 2X Lens 85mm x 50mm Requires 2AA batteries (not included)
2808552	Mag 2.5X Lens 85mm x 50mm Requires 2AA batteries (not included)

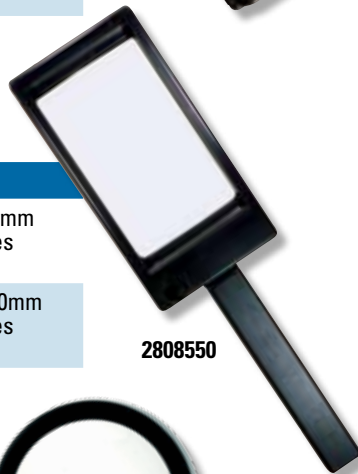

2808550

Deluxe Magnifiers

Part#	Description
2808250	Mag 4.5X Lens 50mm
2808775	Mag 3X Lens 75mm
2808290	Mag 2.5X Lens 90mm
2808345	Mag 2.5X Lens 110mm

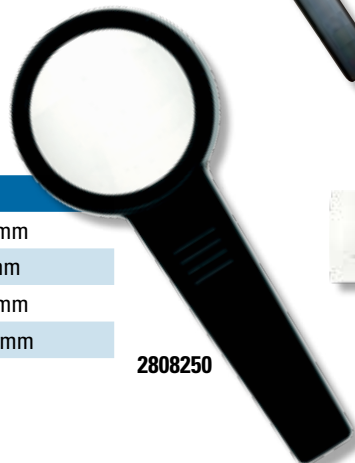

2808250

Tweezer Magnifier

Part#	Description
2801678	Mag 4X



Credit Card Magnifier

Part#	Description
2808554	Mag 2.5X Lens 78mm x 38mm



Half Sheet Magnifier

Part#	Description
2801864	Mag 2X Lens 95mm x 30mm



Full Sheet Magnifier

Part#	Description
2802518	Mag 2X Lens 250mm x 180mm



Ruler Magnifier

Part#	Description
2808010	Mag 2X & 6.5X 300mm x



TOOLS & ACCESSORIES

MAGNIFIERS

Magnifier features:

- Small and portable.
- Useful in many different situations, but do require that the user be able to hold the magnifier steady.



Hobby Helper Magnifier

Part#	Description
2809450	Mag 3X Lens 75mm/Hangs around neck.



10X Fixed Focus Acrylic Base

Part#	Description
2803030	Mag 10X Lens 30mm



Necklace Magnifier

Part#	Description
2808858	Mag 4.5X Lens 75mm



Folding Magnifier

Part#	Description
2808830	Mag 5.5X Lens 30mm



Pocket Magnifier

Part#	Description
2808850	Mag 4.5X Lens 50mm



Jeweller's Eye Magnifier

Part#	Description
2808920	Mag 7.5X Lens 20mm



Double Lens Pocket Magnifier

Part#	Description
2808880	Mag 8X/ 6X Lens 21mm/ 20mm



Triple Lens Pocket Magnifier

Part#	Description
2807073	Mag 4X/ 8X/ 12X

CARPENTER PENCILS

Carpenter pencil features:

- Flat Carpenter Pencil with flat #2HB black graphite lead.
- Blank with no imprint. Custom printing available.
- Boxes of 72 or 140



Carpenter Pencil Accessories

Part#	Description	Box
33670	Carpenter Pencil Holder	12
33788	Pro Carpenter Pencil Sharpener	50
33105	9" Level, Carpenter Pencil w/ Sharpener Pack	6

12mm Carpenter Pencils

Part#	Colour	Lead	Box/Case
33801	Fl. Pink	Medium	72/ 1440
33880	Fl. Orange	Soft	72/ 1440
33890	Fl. Green	Hard	72/ 1440
33900	Red	Red/Black	72/ 1440



15mm Carpenter Pencils

Part#	Colour	Lead	Box/Case
33810	Yellow	Medium	60 /1200
33820	Red	Medium	60 /1200
33830	Sky Blue	Medium	60 /1200
33840	Orange	Medium	60 /1200
33850	White	Medium	60 /1200
33860	Navy Blue	Medium	60 /1200
33870	Black	Medium	60 /1200

SAW BLADES

Saw blade features:

- B54026: Overtime 00504 7-1/4-Inch 24 Tooth FST Thin Kerf Crosscutting and Ripping Saw Blade with 5/8-Inch and Diamond Knockout Arbor, C3 sub micrograin FST grind, Patented grind (24T cuts like 48T), Designed for cord or cordless saw, Iwasaw Certified
- B54027: Overtime 00507 7-1/4-Inch 40 Tooth C3 Carbide Tooth Circular Saw Blade, C3 sub micrograin FST grind, Patented grind (40T cuts like 80T), Designed for cord or cordless saw, Iwasaw Certified.

Saw Blades

Part#	Type	Box/Case
B54024	C3, thin kerf 7 1/4 x 24T saw blade	10/50
B56027	Overtime 7 1/4 x 40T saw blade	N/A/50



Custom 10 Pack Driver Bits or 5 Packs of Nut Drives:

- #1 Profit per square foot
- Customizable 10 pack bit sets
- Customizable 5 pack nut drives
- Countertop point of purchase
- Many options available



FREE DISPLAY Part #100853 included with customized set up of 100 (display holds 18 sets)

Custom Cutters: • Economy • Stainless Steel Reinforced • Pro 6 Blade Auto Load • Heavy Duty Plastic • Extra Heavy Duty Metal Reinforced

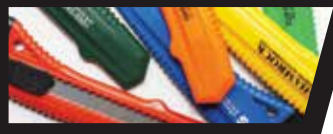

CUSTOMIZED 10 & 50 PACK BLADE PROGRAM

- | | |
|------------------------------|----------------------|
| Eco & Pro Blades: | Low minimums: |
| • Economy | 120 x 10 packs |
| • Hi-Carbon | 60 x 50 packs |
| • Samuri | Ask rep for details. |
| • Serrated | |

★ YOUR LOGO HERE



15 mm Carpenter Pencils

- 60 per box, 1200 per case
- Price breaks at: 1200, 2400, 4800, 6000, 12000, 30000+



Customized or Bulk Saw

- C3 carbide tips
- Thin kerf 1.8mm
 - Coated
 - Vented
- Anti-Twist

Custom runs starting as low as 100 pieces!

Custom Tape Measures

Blade Graduations & Styles:

- Imperial • Metric • Imperial / Metric Combo
- EZE Read, Imperial • Magnetic Hook Imperial
- Magnetic Hook Imperial/Metric • Double Sided Blade

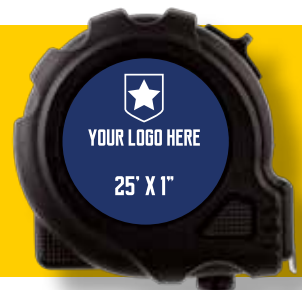

PART#	CAT	PAGE#	PART#	CAT	PAGE#	PART#	CAT	PAGE#	PART#	CAT	PAGE#	PART#	CAT	PAGE#
00024	M	1	00300	M	35	10114	S	7	11121	L	18	11192	C	5
00024-1	M	1	00307	M	18	10115	S	8	11122	L	18	11193	C	5
00032	M	49	00318	M	5	10117	S	8	11125	L	18	11194	C	5
00033	M	49	00325	M	3	10118	S	8	11126	L	18	11197	C	9
00108	S	1	00334	M	15	10119	S	2	11127	L	18	11200	R	32
00112	S	1	00335	M	15	11021	L	2	11131	L	18	11201	R	32
00113	S	2	00386	M	23	11023	L	2	11132	L	18	11202	R	32
00119	S	2	00408	M	23	11024	L	2	11133	L	18	11203	R	32
00121	S	2	00416	M	10	11025	L	1	11134	L	18	11204	R	32
00133	S	3	00417	M	10	11030	L	1	11139	L	9	11205	R	32
00140	S	9	00435	M	20	11032	L	2	11140	L	10	11206	R	32
00141	S	9	00436	M	19	11040	L	1	11141	L	10	11207	R	32
00150	S	10	00438	M	17	11041	L	2	11142	L	10	11208	R	32
00151	S	10	00439	M	19	11043	L	2	11143	L	10	11209	R	32
00152	S	10	00441	M	19	11054	L	2	11144	L	10	11210	R	32
00153	S	11	00447	M	11	11060	L	1	11147	T	1	11220	R	32
00154	S	11	00448	M	12	11061	L	2	11148	T	1	11225	R	32
00155	S	12	00527	M	6	11063	L	2	11149	T	1	11226	R	32
00156	S	12	00557	M	16	11066	L	4	11151	T	1	11227	R	32
00157	S	12	00566	M	20	11070	L	2	11152	T	1	11228	R	32
00158	S	13	00567	M	22	11072	L	8	11153	T	1	11229	R	32
00160	S	9	00611	M	13	11073	L	2	11154	T	1	11230	R	32
00161	S	9	00612	M	14	11076	L	8	11155	T	1	11231	R	32
00163	S	9	00614	M	21	11077	L	8	11156	T	3	11232	R	32
00164	S	9	00619	M	21	11078	L	10	11157	T	3	11233	R	32
00173	S	9	00620	M	18	11083	L	3	11158	T	3	11234	R	32
00174	S	9	00800	M	25	11091	L	6	11159	T	3	11235	R	32
00175	S	9	00801	M	25	11093	L	5	11160	T	3	11236	R	32
00176	S	9	01021	M	26	11094	L	5	11161	T	3	11237	R	32
00177	S	9	01031	M	27	11095	L	5	11162	T	3	11238	R	32
00178	S	9	01032	M	28	11096	L	5	11163	T	3	11239	R	32
00179	S	9	01041	M	31	11097	L	6	11164	T	3	11240	R	32
00180	S	9	01042	M	34	11100	L	18	11166	C	14	11250	T	1
00181	S	9	01042	M	34	11102	L	18	11170	T	2	11251	T	1
00182	S	9	01043	M	2	11104	L	18	11171	T	2	11252	T	1
00189	S	9	10100	S	3	11105	L	18	11174	C	4	11253	T	1
00208	M	2	10101	S	4	11106	L	18	11176	C	3	11254	T	1
00210	M	36	10102	S	4	11107	L	18	11177	C	3	11255	T	1
00215	M	2	10103	S	4	11109	L	18	11178	C	3	11256	T	1
00225	M	11	10104	S	7	11110	L	18	11179	C	4	11257	T	1
00226	M	14	10105	S	5	11112	L	18	11182	C	6	11258	T	1
00235	M	3	10106	S	5	11113	L	18	11183	C	7	11259	T	1
00242	M	7	10107	S	5	11114	L	18	11184	C	7	11260	T	1
00243	M	8	10108	S	6	11115	L	18	11185	C	6	11261	T	1
00244	M	8	10109	S	1	11116	L	18	11186	C	7	11263	T	1
00245	M	9	10110	S	6	11117	L	18	11187	C	7	11284	C	5
00285	M	25	10111	S	6	11118	L	18	11189	C	7	11286	C	5
00296	M	4	10112	S	7	11119	L	18	11190	C	7	11295	C	4
00297	M	24	10113	S	7	11120	L	18	11191	C	5	11296	C	4

PART#	CAT	PAGE#	PART#	CAT	PAGE#	PART#	CAT	PAGE#	PART#	CAT	PAGE#	PART#	CAT	PAGE#
11297	C	4	11415	L	18	11515	T	28	11620	T	13	11787	T	13
11298	C	4	11416	L	18	11520	T	28	11621	T	13	11788	T	13
11299	C	5	11417	L	18	11525	T	28	11622	T	13	11789	T	13
11300	C	12	11418	L	18	11530	T	28	11630	T	14	11794	T	30
11301	C	12	11419	L	18	11535	T	28	11631	T		11800	L	7
11303	C	12	11420	L	18	11540	T	28	11632	T	14	11802	L	7
11304	C	12	11426	L	18	11545	T	28	11633	T	14	11861	T	3
11305	C	12	11427	L	18	11547	T	29	11634	T	14	11864	T	4
11306	C	12	11431	L	18	11548	S	26	11635	T	14	11865	T	4
11308	C	12	11432	L	18	11549	S	26	11636	T	14	11866	T	5
11309	C	12	11433	L	18	11550	S	26	11644	T	10	11867	T	5
11310	C	12	11434	L	18	11560	T	12	11645	T	10	11870	T	5
11312	C	13	11463	T	26	11561	T	12	11647	T	10	11880	T	5
11321	C	14	11465	T	26	11562	T	12	11648	T	10	11890	T	29
11323	C	14	11466	T	25	11563	T	4	11650	T	11	11891	T	29
11324	C	14	11467	T	26	11564	T	4	11652	T	11	11893	T	29
11325	C	14	11468	T	27	11565	T	4	11655	T	10	11895	T	29
11326	C	14	11469	T	27	11566	T	4	11660	T	8	11978	T	15
11328	C	14	11470	T	27	11567	T	4	11661	T	8	11980	T	15
11331	C	14	11471	T	27	11568	T	4	11662	T	8	11981	T	31
11333	C	14	11472	T	27	11569	T	4	11670	T	8	11982	T	31
11334	C	14	11473	T	27	11576	T	9	11671	T	8	11983	T	31
11335	C	14	11474	T	27	11577	T	9	11672	T	8	11984	T	31
11336	C	14	11475	T	27	11579	T	11	11686	T	9	11985	T	31
11338	C	14	11477	T	27	11583	T	9	11687	T	9	11986	T	31
11344	C	12	11479	T	27	11584	T	9	11688	T	9	11988	T	31
11345	C	12	11484	T	26	11585	T	9	11689	T	9	11991	T	31
11350	C	13	11485	T	27	11586	T	8	11690	T	9	11992	T	31
11351	S	28	11487	T	29	11587	T	8	11691	T	9	11993	T	31
11352	S	28	11488	T	29	11588	T	8	11692	T	9	12180	C	6
11354	S	28	11490	T	29	11590	T	9	11693	T	11	12191	C	6
11359	S	26	11491	T	30	11591	T	9	11694	T	11	12195	C	6
11360	S	26	11492	T	29	11592	T	9	11715	T	14	12200	C	10
11361	S	26	11493	T	29	11595	T	11	11716	T	14	12201	C	10
11362	S	26	11494	T	29	11600	T	8	11717	T	14	12203	C	10
11363	S	26	11495	T	29	11601	T	8	11718	T	13	12206	C	7
11369	S	26	11496	T	29	11602	T	8	11719	T	13	12207	C	7
11371	S	26	11497	T	27	11603	T	8	11720	T	13	12208	C	10
11400	L	18	11498	T	27	11604	T	10	11770	T	13	12209	C	10
11402	L	18	11500	T	30	11605	T	10	11771	T	13	12210	C	10
11404	L	18	11501	T	30	11606	T	11	11772	T	13	12226	C	7
11405	L	18	11502	T	30	11607	T	11	11773	T	13	12228	C	7
11406	L	18	11505	T	30	11610	T	14	11774	T	13	12229	C	7
11407	L	18	11507	T	30	11611	T	8	11775	T	13	12230	C	7
11409	L	18	11509	T	30	11612	T	8	11780	T	12	12240	C	11
11410	L	18	11510	T	28	11616	T	14	11782	T	12	12242	C	11
11412	L	18	11511	T	27	11617	T	14	11784	T	12	12243	C	11
11413	L	18	11512	T	27	11618	T	13	11785	T	13	12245	C	11
11414	L	18	11513	T	30	11619	T	13	11786	T	13	12246	C	11

PART#	CAT	PAGE#	PART#	CAT	PAGE#	PART#	CAT	PAGE#	PART#	CAT	PAGE#	PART#	CAT	PAGE#
12247	C	11	12410	C	1	14008	L	24	22536	S	14	22731	S	15
12248	C	11	12411	C	1	14013	L	22	22537	S	14	22732	S	15
12249	C	11	12412	C	1	14014	L	24	22538	S	14	22733	S	15
12250	C	15	12413	C	1	14015	L	21	22539	S	14	22734	S	15
12251	C	15	12414	C	1	14017	L	22	22540	S	14	22735	S	15
12252	C	15	12420	C	1	14018	L	22	22541	S	14	22736	S	15
12253	C	15	12421	C	1	14019	L	25	22542	S	14	22737	S	15
12256	C	15	12423	C	1	14022	L	25	22545	S	14	22738	S	15
12257	C	15	12430	C	1	14023	L	25	22546	S	14	22750	S	13
12259	C	15	12431	C	1	14024	L	23	22547	S	14	22751	S	13
12261	C	2	12432	C	1	14025	L	23	22548	S	14	22752	S	13
12269	C	1	12434	C	1	14026	L	25	22549	S	14	22753	S	13
12270	C	1	12435	C	1	14035	L	22	22550	S	14	22754	S	13
12276	C	1	12441	C	2	14037	L	22	22551	S	14	22755	S	13
12277	C	2	12442	C	2	14040	L	22	22552	S	14	22756	S	13
12282	C	11	12443	C	3	14045	L	23	22553	S	14	22758	S	13
12284	C	11	12444	C	3	14047	L	23	22554	S	14	22760	S	13
12285	C	11	13000	L	19	14140	L	24	22555	S	14	22761	S	13
12291	C	9	13002	L	19	15009	L	21	22700	S	15	22763	S	13
12292	C	9	13003	L	20	15014	L	21	22701	S	15	22782	S	13
12297	C	9	13005	L	20	17715	T	16	22702	S	15	22785	S	13
12300	C	4	13007	L	25	17717	T	16	22703	S	15	22786	S	13
12301	C	4	13008	L	21	17720	R	42	22704	S	15	22789	S	13
12302	C	4	13009	L	20	17722	T	16	22705	S	15	22791	S	13
12303	C	4	13015	L	21	17730	R	42	22706	S	15	22792	S	13
12320	C	7	13019	L	21	17731	R	42	22707	S	15	22795	S	13
12321	C	7	13030	L	19	22500	S	14	22708	S	15	22796	S	13
12322	C	7	13031	L	19	22501	S	14	22709	S	15	22821	S	13
12327	C	6	13100	L	22	22502	S	14	22710	S	15	22822	S	13
12330	C	7	13311	L	23	22503	S	14	22711	S	15	22823	S	13
12331	C	6	13314	L	23	22504	S	14	22712	S	15	22824	S	13
12332	C	6	13402	L	23	22505	S	14	22713	S	15	22825	S	13
12333	C	6	13404	L	23	22509	S	14	22714	S	15	22826	S	13
12335	C	6	13503	L	20	22510	S	14	22715	S	15	22827	S	13
12340	C	7	13504	L	20	22511	S	14	22716	S	15	22828	S	13
12341	C	7	13505	L	20	22512	S	14	22717	S	15	22860	S	23
12342	C	7	13506	L	20	22513	S	14	22718	S	15	22861	S	23
12343	C	7	13507	L	20	22514	S	14	22719	S	15	22862	S	23
12344	C	7	13508	L	20	22518	S	14	22720	S	15	22863	S	23
12346	C	7	13510	L	20	22519	S	14	22721	S	15	22864	S	23
12350	C		13511	L	20	22520	S	14	22722	S	15	22865	S	23
12353	C	7	13550	L	24	22521	S	14	22723	S	15	22866	S	23
12354	C	7	13604	L	19	22522	S	14	22724	S	15	22867	S	23
12361	C	8	13606	L	19	22523	S	14	22725	S	15	22868	S	23
12363	C	8	13607	L	19	22528	S	14	22726	S	15	22869	S	23
12365	C	8	13610	L	19	22529	S	14	22727	S	15	22870	S	23
12370	C	8	13617	L	19	22530	S	14	22728	S	15	22871	S	23
12371	C	8	13624	L	19	22531	S	14	22729	S	15	22872	S	23
12400	C	1	13811	L	24	22532	S	14	22730	S	15	22873	S	24

PART#	CAT	PAGE#	PART#	CAT	PAGE#	PART#	CAT	PAGE#	PART#	CAT	PAGE#	PART#	CAT	PAGE#
22874	S	24	22929	S	25	24005	S	18	24219	S	19	24550	S	21
22875	S	24	22931	S	25	24013	S	18	24221	S	19	24554	S	21
22876	S	24	22932	S	25	24019	S	18	24223	S	19	24556	S	21
22878	S	24	22933	S	25	24023	S	18	24227	S	19	24562	S	21
22879	S	24	22934	S	25	24025	S	18	24231	S	19	24566	S	21
22880	S	24	22935	S	25	24029	S	18	24233	S	19	24570	S	21
22881	S	24	22936	S	25	24031	S	18	24235	S	19	24576	S	21
22882	S	24	22937	S	25	24033	S	18	24239	S	19	24578	S	21
22884	S	24	22938	S	25	24051	S	18	24243	S	19	24580	S	21
22885	S	24	22939	S	25	24055	S	18	24251	S	19	24582	S	21
22886	S	24	22940	S	25	24063	S	18	24253	S	19	24600	S	21
22888	S	24	22942	S	25	24067	S	18	24257	S	20	24604	S	21
22889	S	24	22944	S	25	24069	S	18	24259	S	20	24608	S	21
22890	S	24	22945	S	25	24073	S	18	24261	S	20	24612	S	21
22891	S	24	22946	S	25	24077	S	18	24263	S	20	24614	S	21
22892	S	24	22947	S	25	24081	S	18	24265	S	20	24624	S	21
22893	S	24	22948	S	25	24083	S	18	24267	S	20	24632	S	21
22894	S	24	22949	S	25	24103	S	18	24269	S	20	24650	S	21
22895	S	24	22950	S	25	24105	S	18	24271	S	20	24652	S	21
22896	S	24	22951	S	25	24111	S	18	24273	S	20	24660	S	21
22897	S	24	22952	S	25	24115	S	18	24275	S	20	24664	S	21
22900	S	24	22953	S	25	24117	S	18	24277	S	20	24668	S	21
22901	S	24	22954	S	25	24119	S	18	24281	S	20	24672	S	21
22902	S	24	22955	S	25	24131	S	18	24285	S	20	24676	S	21
22903	S	24	22956	S	25	24133	S	18	24287	S	20	24680	S	21
22904	S	24	22957	S	25	24135	S	18	24289	S	20	24690	S	21
22905	S	24	22958	S	25	24139	S	18	24293	S	20	24692	S	21
22906	S	24	22960	S	25	24141	S	18	24301	S	20	24700	S	22
22907	S	24	22962	S	25	24143	S	18	24303	S	20	24702	S	22
22908	S	24	22963	S	25	24155	S	19	24307	S	20	24704	S	22
22909	S	24	22964	S	25	24157	S	19	24311	S	20	24706	S	22
22910	S	24	22965	S	25	24161	S	19	24313	S	20	24712	S	22
22911	S	24	22966	S	25	24163	S	19	24315	S	20	24714	S	22
22912	S	24	22967	S	25	24165	S	19	24317	S	20	24720	S	22
22913	S	24	22968	S	25	24171	S	19	24319	S	20	24722	S	22
22914	S	24	22970	S	25	24173	S	19	24321	S	20	24724	S	22
22915	S	24	22971	S	25	24175	S	19	24323	S	20	24730	S	22
22916	S	24	22972	S	25	24177	S	19	24325	S	20	24736	S	22
22917	S	24	22973	S	25	24179	S	19	24329	S	20	24740	S	22
22918	S	24	22974	S	25	24181	S	19	24333	S	20	24742	S	22
22919	S	24	22975	S	25	24183	S	19	24337	S	20	24750	S	22
22920	S	24	23050	R	20	24185	S	19	24339	S	20	24752	S	22
22921	S	24	23051	R	20	24187	S	19	24500	S	21	24756	S	22
22922	S	24	23052	R	20	24189	S	19	24510	S	21	24766	S	22
22923	S	24	23053	R	20	24191	S	19	24516	S	21	24768	S	22
22924	S	25	23054	R	20	24193	S	19	24520	S	21	24782	S	22
22925	S	25	23057	T	7	24205	S	19	24526	S	21	24792	S	22
22926	S	25	23058	T	7	24209	S	19	24530	S	21	24802	S	22
22928	S	25	24001	S	18	24215	S	19	24532	S	21	24806	S	22

PART#	CAT	PAGE#	PART#	CAT	PAGE#	PART#	CAT	PAGE#	PART#	CAT	PAGE#	PART#	CAT	PAGE#
24814	S	22	26033	S	16	26082	S	17	27080	T	20	33830	B	21
24818	S	22	26034	S	16	26083	S	17	27082	T	20	33840	B	21
24822	S	22	26035	S	16	26084	S	17	27084	T	20	33850	B	21
24826	S	22	26036	S	16	26085	S	17	27086	T	20	33860	B	21
24830	S	22	26037	S	16	26086	S	17	27088	T	20	33870	B	21
24832	S	22	26038	S	16	26087	S	17	27090	T	20	33880	B	21
24834	S	22	26039	S	16	26088	S	17	27092	T	20	33890	B	21
24836	S	22	26040	S	16	26089	S	17	27093	T	20	33900	B	21
24838	S	22	26041	S	16	26090	S	17	27096	T	20	38200	B	
24850	S	22	26042	S	16	26091	S	17	27098	T	20	38210	B	18
24856	S	22	26043	S	16	26092	S	17	28327	R	33	38220	B	18
24858	S	22	26044	S	16	26093	S	17	28329	R	33	38250	B	
24864	S	22	26045	S	16	26094	S	17	28330	R		38316	B	18
24874	S	22	26046	S	16	26095	S	17	28331	R		38325	B	18
24878	S	22	26047	S	16	26096	S	17	28332	R		38416	B	18
24892	S	22	26048	S	16	26097	S	17	31015	S	31	38425	B	18
24900	S	21	26049	S	16	26098	S	17	31020	S	31	38450	B	18
26001	S	16	26050	S	16	26099	S	17	31025	S	31	38475	B	18
26002	S	16	26051	S	16	26100	S	17	31030	S	31	50915	C	9
26003	S	16	26052	S	16	27002	T	17	31040	S	31	50920	C	9
26004	S	16	26053	S	17	27004	T	17	31050	S	31	50921	C	9
26005	S	16	26054	S	17	27006	T	17	31060	S	31	50922	C	9
26006	S	16	26055	S	17	27008	T	17	31080	S	31	50923	C	
26007	S	16	26056	S	17	27010	T	17	31100	S	31	50930	C	9
26008	S	16	26057	S	17	27015	T	17	31101	S	31	50932	C	9
26009	S	16	26058	S	17	27020	T	17	31102	S	31	50935	C	9
26010	S	16	26059	S	17	27022	T	17	31103	S	31	50936	C	9
26011	S	16	26060	S	17	27024	T	17	32015	S	31	50937	C	9
26012	S	16	26061	S	17	27030	T	18	32020	S	31	50938	C	9
26013	S	16	26062	S	17	27034	T	18	32025	S	31	50939	C	9
26014	S	16	26063	S	17	27036	T	18	32030	S	31	52703	T	25
26015	S	16	26064	S	17	27040	T	18	32040	S	31	54006	L	11
26016	S	16	26065	S	17	27042	T	18	32050	S	31	54007	L	11
26017	S	16	26066	S	17	27044	T	18	32060	S	31	54008	L	11
26018	S	16	26067	S	17	27046	T	18	32080	S	31	54009	L	11
26019	S	16	26068	S	17	27048	T	18	33015	S	31	54010	L	11
26020	S	16	26069	S	17	27050	T	18	33020	S	31	54011	L	11
26021	S	16	26070	S	17	27052	T	18	33025	S	31	54012	L	11
26022	S	16	26071	S	17	27054	T	19	33030	S	31	54013	L	11
26023	S	16	26072	S	17	27056	T	19	33040	S	31	54014	L	11
26024	S	16	26073	S	17	27060	T	19	33050	S	31	54015	L	11
26025	S	16	26074	S	17	27062	T	19	33060	S	31	54016	L	11
26026	S	16	26075	S	17	27064	T	19	33080	S	31	54017	L	11
26027	S	16	26076	S	17	27066	T	19	33105	B	21	54018	L	11
26028	S	16	26077	S	17	27068	T	19	33670	B	21	54019	L	11
26029	S	16	26078	S	17	27070	T	19	33788	B	21	54020	L	11
26030	S	16	26079	S	17	27075	T	19	33801	B	21	54021	L	11
26031	S	16	26080	S	17	27076	T	20	33810	B	21	54022	L	11
26032	S	16	26081	S	17	27078	T	20	33820	B	21	54023	L	11

M: MERCHANDISERS L: LUBRICATION T: TOW-PRO R: CHAIN & RIGGING C: CARGO S: SHOP SUPPLIES B: BOSS

PART#	CAT	PAGE#	PART#	CAT	PAGE#	PART#	CAT	PAGE#	PART#	CAT	PAGE#	PART#	CAT	PAGE#
54024	L	11	54214	L	12	54329	L	13	54515	L	15	55011	R	32
54025	L	11	54215	L	12	54330	L	13	54516	L	15	55012	R	32
54026	L	11	54216	L	12	54331	L	13	54517	L	15	55013	R	32
54027	L	11	54217	L	12	54332	L	13	54518	L	15	55014	R	32
54028	L	11	54218	L	12	54333	L	13	54519	L	15	55030	R	33
54110	L	11	54219	L	12	54334	L	13	54520	L	15	55031	R	33
54111	L	11	54220	L	12	54335	L	13	54521	L	15	55300	R	40
54112	L	11	54221	L	12	54336	L	13	54522	L	15	55301	R	40
54113	L	11	54222	L	12	54337	L	14	54523	L	15	55302	R	40
54114	L	11	54223	L	12	54338	L	14	54524	L	15	55303	R	40
54115	L	11	54224	L	12	54339	L	14	54525	L	15	55304	R	40
54116	L	11	54225	L	12	54340	L	14	54526	L	15	55305	R	40
54117	L	11	54226	L	12	54341	L	14	54527	L	15	55306	R	40
54118	L	11	54227	L	12	54342	L	14	54528	L	15	55307	R	40
54119	L	11	54228	L	12	54343	L	14	54529	L	15	55308	R	40
54120	L	11	54229	L	13	54344	L	14	54530	L	15	55309	R	40
54121	L	11	54230	L	13	54345	L	14	54531	L	15	55310	R	40
54122	L	11	54231	L	13	54346	L	14	54532	L	15	55311	R	40
54123	L	11	54232	L	13	54347	L	14	54901	L	16	55312	R	40
54124	L	11	54233	L	13	54348	L	14	54902	L	16	55313	R	40
54125	L	11	54234	L	13	54349	L	14	54903	L	16	55314	R	40
54126	L	11	54235	L	13	54350	L	14	54904	L	16	55315	R	40
54127	L	11	54236	L	13	54425	L	14	54905	L	16	55316	R	40
54128	L	12	54237	L	13	54426	L	14	54906	L	16	55317	R	40
54129	L	12	54238	L	13	54427	L	14	54907	L	16	55318	R	40
54130	L	12	54239	L	13	54428	L	14	54908	L	16	55319	R	40
54131	L	12	54240	L	13	54429	L	14	54909	L	16	55320	R	40
54132	L	12	54241	L	13	54430	L	14	54910	L	16	55321	R	40
54133	L	12	54242	L	13	54431	L	14	54911	L	16	55322	R	40
54134	L	12	54243	L	13	54432	L	14	54912	L	16	55323	R	40
54135	L	12	54244	L	13	54433	L	14	54913	L	16	55324	R	40
54136	L	12	54245	L	13	54434	L	14	54914	L	16	55325	R	40
54137	L	12	54246	L	13	54435	L	14	54916	L	16	55326	R	40
54138	L	12	54247	L	13	54436	L	14	54918	L	16	55327	R	40
54139	L	12	54248	L	13	54437	L	14	54920	L	16	55328	R	40
54140	L	12	54249	L	13	54501	L	15	54924	L	16	55329	R	40
54141	L	12	54250	L	13	54502	L	15	54928	L	16	55330	R	40
54142	L	12	54251	L	13	54503	L	15	54932	L	16	55331	R	40
54143	L	12	54252	L	13	54504	L	15	55000	R	32	55332	R	40
54144	L	12	54253	L	13	54505	L	15	55001	R	32	55333	R	40
54145	L	12	54254	L	13	54506	L	15	55002	R	32	55334	R	40
54146	L	12	54255	L	13	54507	L	15	55003	R	32	55335	R	40
54147	L	12	54256	L	13	54508	L	15	55004	R	32	55336	R	40
54148	L	12	54257	L	13	54509	L	15	55005	R	32	55337	R	40
54149	L	12	54258	L	13	54510	L	15	55006	R	32	55338	R	40
54210	L	12	54325	L	13	54511	L	15	55007	R	32	55339	R	40
54211	L	12	54326	L	13	54512	L	15	55008	R	32	55340	R	40
54212	L	12	54327	L	13	54513	L	15	55009	R	32	55341	R	40
54213	L	12	54328	L	13	54514	L	15	55010	R	32	55342	R	40

PART#	CAT	PAGE#	PART#	CAT	PAGE#	PART#	CAT	PAGE#	PART#	CAT	PAGE#	PART#	CAT	PAGE#
55343	R	40	55810	R	18	56026	B		65044	R	21	65148	R	23
55344	R	40	55811	R	18	56027	B		65051	R	20	65149	R	23
55345	R	40	55812	R	18	61205	C	16	65052	R	20	65150	R	23
55346	R	40	55813	R	18	62205	C	16	65053	R	20	65151	R	23
55347	R	40	55830	R	18	64000	R	11	65070	R	21	65152	R	23
55348	R	40	55840	R	19	64001	R	11	65071	R	21	65153	R	23
55349	R	40	55841	R	19	64002	R	11	65072	R	21	65161	R	22
55350	R	40	55842	R	19	64003	R	11	65073	R	21	65162	R	22
55400	R	17	55843	R	19	64004	R	11	65074	R	21	65163	R	22
55401	R	17	55850	R	19	64020	R	14	65075	R	21	65164	R	22
55402	R	17	55851	R	19	64021	R	14	65076	R	21	65165	R	22
55403	R	17	55852	R	19	64022	R	14	65077	R	21	65166	R	22
55404	R	17	55853	R	19	64023	R	14	65085	T	6	65172	R	23
55405	R	17	55860	R	19	64024	R	14	65086	T	6	65177	R	23
55406	R	17	55861	R	19	64040	R	14	65087	T	6	65178	R	23
55407	R	17	55862	R	19	64041	R	14	65088	T	31	65181	R	23
55408	R	17	55863	R	19	64042	R	14	65089	T	31	65182	R	23
55409	R	17	55870	R	19	64043	R	14	65090	T	31	65184	R	23
55410	R	17	55871	R	19	64044	R	14	65091	T	7	65185	R	23
55411	R	17	55872	R	19	64060	R	9	65092	T	7	65187	R	23
55412	R	17	55873	R	19	64061	R	9	65093	T	7	65188	R	23
55413	R	17	55880	R	19	64062	R	9	65095	T	5	66000	R	8
55414	R	17	55881	R	19	64063	R	9	65096	T	5	66001	R	8
55415	R	17	55882	R	19	64070	R	31	65102	R	22	66002	R	8
55416	R	17	55883	R	19	64071	R	31	65104	R	22	66003	R	8
55417	R	17	55890	R	20	64072	R	31	65106	R	22	66004	R	8
55418	R	17	55891	R	20	64073	R	31	65107	R	22	66005	R	8
55419	R	17	55892	R	20	64100	R	27	65108	R	22	66006	R	8
55420	R	17	55893	R	20	64101	R	27	65109	R	22	66007	R	8
55421	R	17	55900	R	17	64102	R	27	65110	R	22	66008	R	8
55422	R	17	55901	R	17	64103	R	27	65111	R	22	66010	R	8
55423	R	17	55902	R	17	64104	R	27	65112	R	22	66011	R	8
55424	R	17	55903	R	17	64105	R	27	65113	R	22	66012	R	8
55425	R	17	55904	R	17	64106	R	27	65114	R	22	66013	R	8
55426	R	17	55906	R	18	64107	R	27	65115	R	22	66014	R	8
55427	R	17	55907	R	18	64108	R	27	65117	R	22	66017	R	8
55428	R	17	55908	R	18	64109	R	27	65118	R	22	66020	R	9
55429	R	17	55909	R	18	64110	R	27	65119	R	22	66021	R	9
55430	R	17	55915	R	18	64111	R	27	65120	R	22	66022	R	9
55431	R	17	55916	R	18	65006	R	21	65123	R	22	66023	R	9
55433	R	17	55917	R	18	65014	R	21	65124	R	22	66024	R	9
55434	R	17	55918	R	18	65017	R	21	65140	R	23	66029	R	33
55490	R	17	55919	R	18	65018	R	21	65141	R	23	66030	R	33
55491	R	17	55925	R	18	65020	R	21	65142	R	23	66031	R	33
55492	R	17	55926	R	18	65024	R	21	65143	R	23	66032	R	33
55800	R	18	55927	R	18	65040	R	21	65144	R	23	66033	R	33
55801	R	18	55928	R	18	65041	R	21	65145	R	23	66040	R	33
55802	R	18	56006	R	33	65042	R	21	65146	R	23	66051	R	3
55803	R	18	56010	R	33	65043	R	21	65147	R	23	66052	R	3

M: MERCHANDISERS L: LUBRICATION T: TOW-PRO R: CHAIN & RIGGING C: CARGO S: SHOP SUPPLIES B: BOSS

PART#	CAT	PAGE#	PART#	CAT	PAGE#	PART#	CAT	PAGE#	PART#	CAT	PAGE#	PART#	CAT	PAGE#
66053	R	3	66135	R	6	66210	R	25	66274	T	6	66349	R	28
66054	R	3	66136	R	6	66211	R	25	66275	T	6	66350	R	28
66059	R	8	66137	R	27	66212	R	25	66276	T	6	66351	R	30
66060	R	8	66138	R	9	66213	R	25	66277	T	6	66352	R	29
66061	R	8	66139	R	9	66214	R	25	66280	R	35	66353	R	29
66062	R	8	66140	R	9	66215	R	25	66281	R	35	66354	R	28
66070	R	4	66145	R	6	66216	R	25	66282	R	35	66355	R	29
66071	R	4	66146	R	6	66217	R	25	66283	R	35	66356	R	31
66072	R	4	66147	R	6	66218	R	25	66284	R	35	66360	R	29
66073	R	5	66148	R	6	66219	R	25	66285	R	35	66361	R	29
66074	R	5	66149	R	6	66226	R	25	66286	R	35	66365	R	30
66075	R	5	66150	R	6	66227	R	25	66287	R	35	66366	R	29
66076	R	5	66151	R	6	66228	R	25	66288	R	35	66367	R	30
66080	R	5	66152	R	6	66229	R	25	66300	R	39	66368	R	30
66081	R	5	66153	R	6	66230	R	20	66301	R	39	66369	R	30
66082	R	5	66154	R	6	66232	R	20	66302	R	39	66370	R	30
66083	R	5	66155	R	6	66234	R	20	66303	R	39	66371	R	30
66100	R	22	66156	R	6	66235	R	20	66304	R	39	66372	R	30
66101	R	22	66165	R	10	66236	R	20	66305	R	39	66374	R	30
66102	R	22	66166	R	10	66238	R	20	66306	R	39	66375	R	30
66103	R	22	66167	R	10	66239	R	20	66307	R	39	66376	R	30
66104	R	22	66168	R	10	66241	C	5	66308	R	39	66377	R	30
66105	R	22	66173	R	24	66244	R	37	66309	R	39	66380	R	30
66106	R	22	66174	R	24	66245	R	37	66310	R	39	66381	R	30
66107	R	22	66175	R	24	66246	R	37	66311	R	39	66385	R	30
66108	R	22	66176	R	24	66247	R	37	66312	R	39	66387	R	31
66110	R	5	66178	R	24	66248	R	37	66313	R	39	66390	R	24
66111	R	5	66179	R	24	66249	R	37	66317	R	39	66392	R	31
66112	R	5	66180	R	24	66250	R	34	66318	R	39	66394	R	30
66113	R	5	66182	R	24	66251	R	36	66320	R	39	66400	R	10
66114	R	5	66184	R	24	66252	R	36	66325	R	39	66401	R	10
66115	R	5	66185	R	11	66253	R	36	66326	R	39	66402	R	10
66116	R	5	66186	R	11	66254	R	36	66328	R	39	66403	R	10
66117	R	5	66187	R	11	66255	R	36	66330	R	27	66404	R	10
66118	R	5	66188	R	11	66256	R	36	66331	R	27	66410	R	24
66119	R	5	66196	C	16	66257	R	36	66332	R	28	66411	R	24
66120	R	5	66197	C	16	66258	R	36	66334	R	28	66412	R	24
66121	R	5	66198	C	16	66259	R	36	66335	R	28	66413	R	10
66122	R	5	66199	C	16	66260	R	36	66336	R	28	66414	R	10
66123	R	5	66200	C	16	66261	R	36	66338	R	28	66415	R	10
66124	R	5	66201	C	16	66263	R	36	66339	R	28	66416	R	11
66125	R	5	66202	C	16	66265	T	7	66340	R	28	66417	R	11
66126	R	5	66203	C	16	66266	T	7	66341	R	29	66418	R	11
66127	R	5	66204	C	16	66267	T	7	66342	R	28	66419	R	31
66129	R	4	66205	C	16	66268	T	7	66343	R	28	66420	R	31
66130	R	4	66206	R	24	66269	T	7	66344	R	28	66421	R	31
66131	R	4	66207	R	24	66270	T	7	66346	R	28	66422	R	31
66133	R	6	66208	R	24	66271	T	7	66347	R	29	66423	R	21
66134	R	6	66209	R	24	66272	T	7	66348	R	28	66424	R	21

PART#	CAT	PAGE#	PART#	CAT	PAGE#	PART#	CAT	PAGE#	PART#	CAT	PAGE#	PART#	CAT	PAGE#
66425	R	31	66508	R	34	66612	R	41	66825	R	26	66889	R	36
66426	R	31	66509	R	34	66619	R	41	66826	R	26	66890	R	36
66427	R	31	66510	R	34	66620	R	41	66827	R	26	66900	R	9
66428	R	31	66511	R	34	66621	R	41	66828	R	26	66901	R	9
66429	R	31	66514	R	34	66622	R	41	66829	R	26	66902	R	9
66430	R	11	66515	R	34	66623	R	41	66830	R	26	66903	R	9
66431	R	11	66516	R	34	66624	R	41	66831	R	26	66904	R	9
66432	R	11	66518	R	34	66625	R	41	66832	R	26	66905	R	9
66433	R	11	66519	R	34	66626	R	41	66833	R	26	66906	R	9
66434	R	11	66520	R	34	66642	R	41	66840	R	26	66907	R	9
66435	R	11	66524	R	34	66760	R	34	66841	R	26	66908	R	9
66436	R	11	66525	R	34	66762	R	34	66842	R	26	66959	R	9
66440	R	10	66526	R	34	66763	R	34	66843	R	26	66960	R	9
66441	R	10	66527	R	34	66764	R	34	66844	R	26	67005	R	7
66442	R	10	66528	R	34	66765	R	34	66845	R	26	67006	R	7
66443	R	10	66530	R	34	66766	R	34	66846	R	26	67007	R	7
66444	R	10	66531	R	38	66767	R	34	66847	R	26	67008	R	7
66445	R	10	66532	R	38	66768	R	34	66848	R	26	67020	R	7
66450	R	37	66533	R	38	66769	R	34	66849	R	26	67021	R	7
66451	R	37	66534	R	38	66770	R	34	66850	R	26	67022	R	7
66452	R	37	66535	R	38	66771	R	34	66851	R	26	67023	R	7
66453	R	37	66536	R	38	66772	R	34	66860	R	36	67025	R	7
66454	R	37	66537	R	38	66773	R	34	66861	R	36	67026	R	7
66455	R	37	66538	R	38	66780	R	35	66862	R	36	67027	R	7
66460	R	38	66539	R	38	66781	R	35	66863	R	36	67030	R	7
66461	R	38	66560	R	42	66782	R	35	66864	R	36	67031	R	7
66462	R	38	66561	R	42	66783	R	35	66865	R	36	67032	R	7
66463	R	38	66562	R	42	66784	R	35	66866	R	36	67040	R	8
66464	R	38	66563	R	42	66785	R	35	66867	R	36	67041	R	8
66465	R	38	66565	R	42	66786	R	35	66868	R	36	67042	R	8
66466	R	38	66566	R	42	66787	R	35	66869	R	36	67050	R	8
66467	R	38	66567	R	42	66788	R	35	66870	R	36	67051	R	8
66468	R	38	66580	R	42	66800	R	25	66871	R	36	67052	R	8
66469	R	38	66581	R	42	66801	R	25	66872	R	35	67145	R	7
66470	R	34	66582	R	42	66802	R	25	66873	R	35	67146	R	7
66472	R	34	66583	R	42	66803	R	25	66874	R	35	67147	R	7
66474	R	34	66584	R	42	66804	R	25	66875	R	35	67148	R	7
66489	R	34	66585	R	42	66805	R	25	66876	R	35	67149	R	7
66490	R	34	66586	R	42	66806	R	25	66877	R	35	68010	R	16
66491	R	34	66587	R	42	66807	R	25	66878	R	35	68011	R	16
66492	R	34	66588	R	42	66808	R	25	66880	R	26	68012	R	16
66493	R	34	66589	R	42	66809	R	25	66881	R	26	68013	R	16
66494	R	34	66590	R	42	66810	R	25	66882	R	37	68014	R	16
66499	R	34	66591	R	42	66811	R	25	66883	R	37	68015	R	16
66500	R	34	66592	R	42	66820	R	26	66884	R	37	68100	R	16
66501	R	34	66602	R	41	66821	R	26	66885	R	37	70003	R	1
66503	R	34	66604	R	41	66822	R	26	66886	R	36	70004	R	1
66505	R	34	66608	R	41	66823	R	26	66887	R	36	70005	R	1
66507	R	34	66610	R	41	66824	R	26	66888	R	36	70006	R	1

PART#	CAT	PAGE#	PART#	CAT	PAGE#	PART#	CAT	PAGE#	PART#	CAT	PAGE#	PART#	CAT	PAGE#
70007	R	1	72152	B	1	75151	B	1	77062	R	14	78133	B	1
70008	R	1	72153	B	1	75152	B	1	77063	R	14	78134	B	1
70010	M	42	72181	B	1	75153	B	1	77064	R	14	78141	B	1
70013	R	1	72182	B	1	77000	R	12	77065	R	14	78142	B	1
70014	R	1	72183	B	1	77001	R	12	77066	R	14	78143	B	1
70015	R	1	72200	B	2	77002	R	12	77067	R	14	78151	B	1
70016	R	1	72201	B	2	77003	R	12	77068	R	14	78152	B	1
70020	R	1	72202	B	2	77004	R	12	77070	R	15	78153	B	1
70021	R	1	72203	B	2	77005	R	12	77071	R	15	78182	B	1
70022	R	1	72220	B	2	77006	R	12	77072	R	15	78200	B	2
70023	R	1	72221	B	2	77007	R	12	77073	R	15	78201	B	2
70024	R	1	72222	B	2	77010	R	12	77074	R	15	78202	B	2
70025	R	1	72223	B	2	77011	R	12	77075	R	15	78203	B	2
70026	R	1	72228	B	4	77012	R	12	77080	R	15	78205	B	4
70034	R	1	72229	B	4	77013	R	12	77081	R	15	78210	B	2
70035	R	1	72230	B	2	77014	R	12	77082	R	15	78211	B	2
70036	R	1	72231	B	2	77015	R	12	77083	R	15	78212	B	2
70040	R	1	72232	B	2	77016	R	12	77084	R	15	78213	B	2
70045	R	2	72233	B	2	77017	R	12	77085	R	15	78220	B	2
70050	R	2	72241	B	2	77020	R	12	77086	R	15	78221	B	2
70051	R	2	72242	B	2	77030	R	13	77087	R	15	78222	B	2
70060	R	2	72243	B	2	77031	R	13	77100	R	16	78223	B	2
70061	R	2	72251	B	2	77032	R	13	77101	R	16	78228	B	4
70062	R	2	72252	B	2	77033	R	13	77107	R	16	78229	B	4
70063	R	2	72253	B	2	77034	R	13	77116	R	16	78230	B	2
70075	R	2	72282	B	2	77035	R	13	77799	M	46	78231	B	2
70080	R	2	73110	B	6	77036	R	13	77801	M	46	78232	B	2
70085	R	3	73111	B	6	77037	R	13	77804	M	46	78233	B	2
70086	R	3	73112	B	6	77038	R	13	77850	M	47	78234	B	2
70087	R	3	73113	B	6	77039	R	13	77851	M	47	78241	B	2
70096	M	43	73114	B	6	77040	R	13	77852	M	47	78242	B	2
70098	M	50	73115	B	6	77041	R	13	77858	M	48	78243	B	2
70099	M	42	73210	B	6	77042	R	13	77890	M	51	78251	B	2
72100	B	1	73211	B	6	77043	R	13	78055	T	25	78252	B	2
72101	B	1	73212	B	6	77044	R	13	78100	B	1	78253	B	2
72102	B	1	73213	B	6	77045	R	13	78101	B	1	78300	B	2
72103	B	1	73214	B	6	77046	R	13	78102	B	1	78301	B	2
72120	B	1	74121	B	1	77047	R	13	78103	B	1	78302	B	2
72121	B	1	74122	B	1	77048	R	13	78110	B	1	78303	B	2
72122	B	1	74123	B	1	77049	R	13	78111	B	1	78320	B	2
72123	B	1	75121	B	1	77050	R	14	78112	B	1	78321	B	2
72130	B	1	75122	B	1	77051	R	14	78113	B	1	78322	B	2
72131	B	1	75123	B	1	77052	R	14	78120	B	1	78323	B	2
72132	B	1	75131	B	1	77053	R	14	78121	B	1	78331	B	2
72133	B	1	75132	B	1	77054	R	14	78122	B	1	78332	B	2
72141	B	1	75133	B	1	77055	R	14	78123	B	1	78341	B	2
72142	B	1	75141	B	1	77056	R	14	78130	B	1	78342	B	2
72143	B	1	75142	B	1	77060	R	14	78131	B	1	78351	B	2
72151	B	1	75143	B	1	77061	R	14	78132	B	1	78352	B	2

PART#	CAT	PAGE#	PART#	CAT	PAGE#	PART#	CAT	PAGE#	PART#	CAT	PAGE#	PART#	CAT	PAGE#
78400	B	3	78527	B	4	79150	B	6	80112	S	30	80345	S	28
78401	B	3	78530	B	4	79151	B	6	80113	S	30	80350	S	28
78402	B	3	78531	B	4	79152	B	6	80115	S	30	80355	S	28
78403	B	3	78532	B	4	79153	B	6	80116	S	30	80360	S	28
78404	B	3	78533	B	4	79210	B	6	80117	S	30	80365	S	28
78405	B	3	78534	B	4	79211	B	6	80118	S	30	81725	T	21
78406	B	3	78535	B	4	79212	B	6	80120	S	30	81790	T	21
78417	B	3	78536	B	4	79213	B	6	80121	S	30	82122	B	
78418	B	3	78537	B	4	79214	B	6	80122	S	30	92500	S	14
78419	B	3	78551	B	5	79258	B	6	80123	S	30	92502	S	14
78420	B	3	78552	B	5	79259	B		80124	T	30	92504	S	14
78421	B	3	78553	B	5	79260	B	7	80128	T	30	92509	S	14
78422	B	3	78554	B	5	79262	B	7	80130	T	30	92511	S	14
78423	B	3	78555	B	5	79264	B	7	80132	T	30	92513	S	14
78424	B	3	78556	B	5	79268	B	7	80228	B	4	92518	S	14
78425	B	3	78557	B	5	79284	B	7	80229	S	30	92520	S	14
78426	B	3	78558	B	5	79310	B	6	80250	S	29	92522	S	14
78427	B	3	78600	B	4	79311	B	6	80251	S	29	92529	S	14
78428	B	3	78601	B	4	79312	B	6	80252	S	29	92538	S	14
78429	B	3	78602	B	4	79313	B	6	80253	S	29	92540	S	14
78430	B	3	78603	B	4	79314	B	6	80254	S	29	96300	R	39
78431	B	3	78620	B	4	79352	B	6	80259	S	29	96301	R	39
78432	B	3	78621	B	4	79353	B	6	80260	S	29	96302	R	39
78433	B	3	78622	B	4	79410	B	6	80261	S	29	96303	R	39
78434	B	3	78623	B	4	79411	B	6	80262	S	29	96304	R	39
78435	B	3	78630	B	4	79412	B	6	80263	S	29	96305	R	39
78436	B	3	78631	B	4	79413	B	6	80264	S	29	96306	R	39
78450	B	5	78632	B	4	79440	B	7	80270	S	28	96307	R	39
78451	B	5	78633	B	4	79560	B	6	80271	S	28	96308	R	39
78452	B	5	78700	B	5	79580	B	6	80272	S	28	96311	R	39
78453	B	5	78702	B	5	79660	B	6	80273	S	28	96312	R	39
78454	B	5	78703	B	5	79664	B	6	80280	S	28	96450	R	37
78455	B	5	78705	B	5	79707	B	6	80281	S	28	96451	R	37
78456	B	5	78806	B	5	79708	B	6	80282	S	28	96452	R	37
78500	B	4	78808	B	5	79709	B	6	80283	S	28	96453	R	37
78501	B	4	78810	B	5	79710	B	6	80290	S	28	96454	R	37
78502	B	4	78812	B	5	79712	B	6	80291	S	28	96455	R	37
78503	B	4	78920	B	5	79715	B	6	80292	S	28	96460	R	38
78504	B	4	78921	B	5	79717	B	6	80293	S	28	96461	R	38
78505	B	4	78922	B	5	79860	B	6	80301	S	28	96462	R	38
78506	B	4	78923	B	5	79864	B	6	80302	S	28	96463	R	38
78507	B	4	78924	B	5	80100	M	45	80303	S	28	96464	R	38
78520	B	4	78925	B	5	80101	S	30	80305	S	28	96465	R	38
78521	B	4	79050	B	6	80102	S	32	80320	S	28	96466	R	38
78522	B	4	79110	B	6	80103	M	44	80321	S	28	96467	R	38
78523	B	4	79111	B	6	80105	S	32	80322	S	28	96468	R	38
78524	B	4	79112	B	6	80107	S	32	80323	S	28	96469	R	38
78525	B	4	79113	B	6	80109	S	32	80330	S	28	97070	R	15
78526	B	4	79114	B	6	80111	S	32	80335	S	28	97071	R	15

PART#	CAT	PAGE#	PART#	CAT	PAGE#	PART#	CAT	PAGE#	PART#	CAT	PAGE#	PART#	CAT	PAGE#
97072	R	15	771400	B	10	2251571	B	17	2558229	B	13	2808850	B	20
97073	R	15	771410	B	10	2251730	B	17	2558230	B	13	2808858	B	20
97074	R	15	771500	B	10	2251731	B	17	2558231	B	13	2808880	B	20
97075	R	15	774440	B	10	2251740	B	17	2558232	B	13	2808920	B	20
97080	R	15	777586	B	8	2251741	B	17	2558233	B	13	2809450	B	20
97081	R	15	793520	B	10	2251840	B	17	2558234	B	13	00031A	M	4
97082	R	15	801678	B	19	2251841	B	17	2558806	B	13	00031B	M	4
97083	R	15	802518	B	19	2251850	B	17	2558807	B	13	00031K	M	4
97084	R	15	803030	B	20	2251851	B	17	2558808	B	13	00057K	M	32
97085	R	15	851000	B	11	2253540	B	17	2560008	B	12	00063K	M	30
100805	M	52	851002	B	11	2253541	B	17	2560009	B	12	00208K	M	2
204337	B	16	851004	B	11	2253554	B	17	2560100	B	13	00210K	M	36
231333	B	16	851006	B	11	2550008	B	12	2560151	B	12	00215K	M	2
234439	B	16	851008	B	11	2550009	B	12	2560200	B	13	00225K	M	11
234440	B	16	851010	B	11	2550100	B	13	2560406	B	14	00226K	M	14
333607	M	50	851012	B	11	2550151	B	12	2560425	B	13	00235K	M	3
546750	B	13	851014	B	11	2550200	B	13	2560430	B	14	00242A	M	7
546760	B	13	851016	B	11	2550406	B	14	2560488	B	12	00242B	M	7
546900	B	14	851018	B	11	2550425	B	13	2561802	B	12	00242K	M	7
546920	B	14	851020	B	11	2550430	B	14	2562130	B		00243C	M	8
548687	B	13	851022	B	11	2550488	B	12	2562600	B	14	00243K	M	8
548688	B	13	851024	B	11	2551802	B	12	2563208	B	12	00244K	M	8
550440	B	14	851026	B	11	2553208	B	12	2564303	B	15	00245K	M	9
550460	B	14	851028	B	11	2554003	B	15	2564333	B	15	00255K	M	25
550470	B	14	851030	B	11	2554033	B	15	2564403	B	15	00265K	M	25
550480	B	14	851032	B	11	2554303	B	15	2564405	B	15	00275K	M	25
556750	B	13	851034	B	11	2554305	B	15	2564406	B	15	00296K	M	4
556760	B	13	851036	B	11	2554333	B	15	2564433	B	15	00297K	M	24
556900	B	14	851038	B	11	2554402	B	15	2565010	B	15	00300K	M	35
556920	B	14	851040	B	11	2554403	B	15	2565050	B	15	00307K	M	18
558601	M	51	851042	B	11	2554404	B	15	2565403	B	15	00318K	M	5
558602	M	51	851044	B	11	2554405	B	15	2565423	B	15	00325K	M	3
559110	B	14	851046	B	11	2554406	B	15	2801678	B	19	00334K	M	15
568687	B	13	851048	B	11	2554407	B	15	2801864	B	19	00335A	M	15
568688	B	13	851050	B	11	2554415	B	15	2802518	B	19	00335B	M	15
711201	B	8	851052	B	11	2554416	B	15	2807073	B	20	00335K	M	15
711221	B	8	851054	B	11	2554433	B	15	2807550	B	19	00386K	M	23
711245	B	8	851056	B	11	2554505	B	15	2807590	B	19	00408K	M	23
711252	B	8	2251525	B	17	2555000	M	51	2808010	B	19	00416K	M	10
711269	B	8	2251526	B	17	2555010	B	15	2808200	M	49	00417K	M	10
711276	B	8	2251530	B	17	2555050	B	15	2808237	B	19	00435K	M	20
711283	B	8	2251531	B	17	2555403	B	15	2808250	B	19	00436K	M	19
717186	B	8	2251540	B	17	2555423	B	15	2808290	B	19	00438K	M	17
721374	B	9	2251541	B	17	2558066	B	12	2808345	B	19	00439K	M	19
721386	B	9	2251550	B	17	2558067	B	12	2808550	B	19	00441K	M	19
724240	B	9	2251551	B	17	2558068	B	12	2808552	B	19	00447K	M	11
724244	B	9	2251560	B	17	2558129	B	12	2808554	B	19	00448K	M	12
771225	B	8	2251561	B	17	2558130	B	12	2808768	B	19	00465K	M	43
771395	B	10	2251570	B	17	2558228	B	13	2808775	B	19	00527K	M	6

PART#	CAT	PAGE#	PART#	CAT	PAGE#	PART#	CAT	PAGE#	PART#	CAT	PAGE#
00557K	M	16	11116A	L	18	11802-4	L	7	B54027	B	21
00566K	M	20	11117A	L	18	11802-5	L	7	B54124	B	18
00567K	M	22	11118A	L	18	11802-6	L	7	B54135	B	18
00611K	M	13	11119A	L	18	11802-7	L	7	C30030	L	20
00612K	M	14	11120A	L	18	11802-8	L	7	C30050	L	20
00614K	M	21	11121A	L	9	12229B	C	8	C30080	L	20
00619K	M	21	11123A	L	9	12343B	C	8	C30090	L	20
00620K	M	18	11124A	L	9	12344B	C	8	C30150	L	21
00626K	M	29	11125A	L	9	12353B	C	8	C30190	L	21
00638K	M	32	11126A	L	18	12354B	C	8	C30300	L	19
00716K	M	40	11127A	L	18	14045X	L	23	C30310	L	19
00746K	M	41	11131A	L	18	66270P	T	7	C30450	L	20
01021K	M	26	11132A	L	18	66271P	T	7	C33110	L	23
01031K	M	27	11133A	L	18	67030-1	R	7	C33140	L	23
01032K	M	28	11134A	L	18	67031-1	R	7	C34020	L	23
01041K	M	31	11135A	S	9	67032-1	R	7	C34026	L	23
01042K	M	34	11136A	S	9	67040-1	R	8	C34040	L	23
01043K	M	2	11139A	L	9	67041-1	R	8	C34046	L	23
01101K	M	39	11142A	L	10	67042-1	R	8	C35040	L	20
100805A	M	53	11143A	L	10	70005-A	R	1	C35050	L	20
100805B	M	53	11147P	T	2	70010K	M	43	C35070	L	20
100805C	M	53	11148P	T	2	70098K	M	50	HB1218	M	45
11061-1	L		11149P	T	2	70099K	M	42	HB1525	M	45
11066-1	L	4	11151P	T	2	78A22	B		HB2035	M	45
11071A	L	8	11152P	T	2	80100K	M	45	HB2045	M	45
11075A	L	8	11153P	T	2	80103K	M	44	HB3045	M	45
11079A	L	9	11154P	T	2	80259-1	S	29	TF306	M	44
11080A	L	8	11155H	T	2	80259-2	S	29	TF308	M	44
11081A	L	9	11155HP	T	2	80260-1	S	29	TF604	M	44
11082C	L	3	11155P	T	2	80260-2	S	29	TF605	M	44
11084A	L	4	11155X	T	2	80261-1	S	29	Call Us!	M	49
11085A	L	3	11155XP	T	2	80261-2	S	29			
11087A	L	4	11159N	T	2	80262-1	S	29			
11089A	L	4	11183B	C	8	80262-2	S	29			
11090A	L	5	11184B	C	8	80263-1	S	29			
11092A	L	6	11186B	C	8	80263-2	S	29			
11094A	L	6	11187B	C	8	80264-1	S	29			
11100A	L	18	11189B	C	8	80264-2	S	29			
11102A	L	18	11190B	C	8	81741B	T	21			
11104A	L	18	11251P	T	2	81780HBC	T	22-23			
11105A	L	18	11252P	T	2	81782HBC	T	22-23			
11106A	L	18	11260P	T		81783HBC	T	22-23			
11107A	L	18	11477-1	T	30	81785HBC	T	22-23			
11109A	L	18	11481-1	T	30	81786HBC	T	22-23			
11110A	L	18	11488-1	T	30	81788HBC	T	22-23			
11112A	L	18	11492-1	T	26	81789HBC	T	22-23			
11113A	L	18	11802-1	L	7	81794HBC	T	22-23			
11114A	L	18	11802-2	L	7	900-CTD	L				
11115A	L	18	11802-3	L	7	B54024	B	21			

M: MERCHANDISERS L: LUBRICATION T: TOW-PRO R: CHAIN & RIGGING C: CARGO S: SHOP SUPPLIES B: BOSS

PART#	CAT	PAGE#	PART#	CAT	PAGE#
1 Each Sq. Phillips Slotted 10 Pack Colored	B	8	Blade Single Edge	B	15
10 Pack	B	8	Blade Utility	B	15
10 Pack Assorted	B	8	Blue Magnetic Nut Driver 9/16" x 2.5" long	B	6
2 Blade Heavy Duty Knob Lock	B	13	Bolt Snap	R	28
2 Pole Flat Connector	T	17	Bolt-Type Anchor Shackle	R	9
33 Piece Security Set Industrial Quality - S2 STEEL	B	10	Boss Product End Cap	M	53
5th Wheel King Pin Stabilizer, 5000lbs	T	30	Bottom Hook Replacement	S	29
9 Piece Hex Key Ball Set 1/16" to 3/8"	B	10	Bowl and Extension Tube Kit	L	7
Adjustable Ball Mount	T	12	Bowl Kit	L	7
Adjustable Bracket	T	5	Brake Controller Merchandiser	M	2
Adjustable Coupler	T	4	Brake Controller Overlay	M	2
Adjustable Tow Bar, 5000 lbs	T	5	Brass Bolt Snap	R	29
A-Frame Jack	T	29	Brass Deep Nut Driver	B	6
A-Frame Side Wind Jack	T	26	Brass Drywall	B	4
Aircraft Cable	R	12	Brass Magnetic Nut Driver 7/16" x 2.5" long	B	6
Allen Cap Screw Assortment	S	7	Brass Padlock	B	17
Alloy Eye Hoist Hook	R	7	Breakaway Switch 4ft 16ga Wire	T	20
Alloy Grab Hook C/W Latch (Alloy)	R	5	Bulk Display Shelf	M	49
Alloy Hoist Hook	R	7	Bull Snap 1	R	27
Aluminum Pulley Merchandiser 24" x 24" (2)	M	15	Bungee Balls - 12/pkg	C	4
Anchor Point - Chrome	C	14	Bungee Cord Assortment	C	2-3
Anchor Ring H.D.	C	15	Bushing Bronze	R	40
Anchor Rings	C	15	Bushing Bronze Merchandiser 12" x 24"	M	3
Anchor Shackle	R	8	Bushing for Jack Handle	T	30
Animal Snap Bronze Cast 1"	R	31	Bushing Lift Arm	R	41
Assortments - 4'x4' Overlay	M	26	Bushing Machine	S	15
Assortments Plan-O-Gram	M	26	Bushings Machinery Merchandiser 12" x 24"	M	3
ATV Ball Mount Adapter	T	10	C3 Circular Blade Box of 10	B	21
Auto Electrical Repair Kit	S	3	Cable Cutter	R	16
Auto Fuse Assortment	S	6	Cable Lock	T	5
Automotive Driver Bit Display	M	46	Cable Puller 1 Ton	S	28
Baby Square Eye Snap 5/8"	R	30	Cable Puller 2 Ton	S	28
Ball Mount	T	8	Cable Puller 4 Ton	S	28
Ball Mount - Adjustable	T	11	Cable Sleeve Dynapak	R	15
Ball Mount Kit	T	9	Cable Stop Dynapak	R	15
Ball Mount Rack Merchandiser	M	36	Cable Type Load Binder Lock	C	16
Ball Mount Solid Steel Welded	T	9	Calibrated Measurer Container w/lid	L	23
Ball Mount Triple Adjustable	T	11	Calibrated Measuring Container	L	23
Ball Mount, Forged Aluminum	T	9	Cam & Ratchet Combo. 4 Pack Black	C	6
Ball Mount, Forged, Drop	T	9	Cam Strap	C	6
Ball Mount Super Duty, Drop, Welded	T	9	Cam Strap H.D.	C	6
Battery Filler - 2 Litre	L	23	Cap Snap 1	R	28
Beam Clamp	S	28	Cargo Net	C	4
Bearing for Wheel	S	30	Cargo Winch	C	11
Bench Swager	R	16	Carpenter Pencil	B	21
Bit Drywall ACR	B	4	Carpenter Pencil Display	M	50
Black Deep Nut Driver 1/2"x2.5" long	B	6	Carpenter Pencil Holder	B	21
Blade and Cutter Display	M	51	Caster Kit	L	7
Blade Heavy Duty	B	15	Castors Display Board	M	35
Blade Heavy Duty Serrated	B	15	Castors Merchandiser 48" x 72"	M	35

PART#	CAT	PAGE#	PART#	CAT	PAGE#
Ceiling Tile Hanger Driver 1/4"x2.5" long	B	7	Dog Lead Snap 3/8	R	28
Chain Connectors Merchandiser 12" x 24"	M	21	Double Adjustable Ball Mount	T	12
Chain Grade 30	R	1	Double Bolt Snap 7/16	R	28
Chain Grade 70	R	1	Double Loop Lion Ch	R	2
Chain Hoist	S	29	Double Loop Lion Chain	R	2
Chain Hooks Board 24" x 24"	M	23	Drain Hose Kit	L	7
Chain Merchandiser - 2 ft	M	43	Drain Pan	L	25
Chain Merchandiser - 4 ft	M	42	D-Ring	R	24
Chain Rack - 2 ft & 4 ft Rack only	M	42	Drop Leg Side Wind Jack	T	29
Chrome Ball Mount,Drop	T	8	Drop Leg Top Wind Jack	T	29
Clevis Ball Mount	T	11	Drywall Saw, Teflon Double Side Blade	B	18
Clevis Grab Hook	R	5	Drywall Stopper	B	4
Clevis Grab Hook (Alloy)	R	5	Dual Ball Mount	T	10
Clevis Grab Hook Alloy	R	5	Dual Hitch Extension, 4000lbs	T	12
Clevis Grab Hook Grade 80	R	7	Dual View Clip Towing Mirror	T	16
Clevis Pin	S	14	Dynakits Merchandiser 12" x 24"	M	4
Clevis Pin Dynakit	S	9	Dynapak	L	9
Clevis Pin Dynapak	S	14	Dynatray Merchandiser 24" x 24" (2)	M	4
Clevis Sling Hook Grade 80	R	7	E Retainer Ring Dynakit	S	9
Clevis Slip Hook	R	5	Ease-Guide Coupler	T	4
Clevis Slip Hook C/W Latch	R	4	Easy Flow Funnel	L	25
Clevis Slip Hook C/W Latch (Alloy)	R	5	Economy Blade	B	15
Clip Towing Mirror	T	16	Economy Cutter	B	13
Cold Shut	R	10	Economy Heavy Duty Blade	B	15
Colored Driver Bit Set	B	9	E-Grip & Forged Steel Hitch Pin Merchandiser 24" x 24"	M	19
Combination Padlock	B	17	E-Grip Hitch Pin	R	35
Comfort Grip Cutter	B	13	End Cap - Display Only	M	52
Commercial Anchor	R	8	Energize III Brake Controller	T	21
Compact Driver Bit Display	M	46	Ergo Auto Lock RED Bulk	B	13
Connecting Link Grade 80	R	7	Ergo Grip Knob Lock Cutter	B	13
Copper Washer Assortment	S	7	Ergo KL Cutter with Serrated Blade	B	14
Cornice Hook	R	21	Ergo Knob Lock YELLOW Bulk	B	13
Cotter Pin Assortment	S	4	Evermark 16' Tape SAE/Metric	B	18
Cotter Pin Dynakit (Small & Large)	S	9	Ext E Retainer Ring Assortment	S	7
Counter Top Blade Display	M	51	External Retainer Ring Dynakit	S	9
Coupler & Receiver Lock Set	T	6	External Snap Ring Assortment	S	5
Coupler 1/8" NPT Pkgd 360 Degree Swivel	L	8	Extra Heavy Duty Cutter	B	12
Coupler Gooseneck	T	4	Eye Bull Snap 3/4"x 3-3/4"	R	30
Coupler Lock	T	6	Eye Grab Hook	R	5
Coupler Repair Kit 1-7/8	T	3	Eye Hoist Hook	R	6
Custom Dynaline Banner	M	49	Eye Slip Hook	R	4
Cutters	B	12-13	Eyebolt	R	22
Cylinder Pin	R	33	Eyebolts & Rings Merchandiser 24" x 24"	M	13
Damaged Screw Remover 3 pack	B	10	E-Z Clip	T	7
Deep Nut Drive	B	6	Farm Hardware - 4x4 Plan-0-Gram	M	39
Deluxe Door Mount Mirror	T	16	Farm Paks Merchandiser 24" x 24"	M	18
Demagnetizer/Magnetizer	B	10	Ferrule	R	15
Diaphragm Pump for Fuels	L	7	Fixed Caster	S	31
Die Cast Pulley	R	17	Fixed Caster Pneumatic	S	31
Dirt Free Funnel Dirt Free	L	22			

M: MERCHANDISERS L: LUBRICATION T: TOW-PRO R: CHAIN & RIGGING C: CARGO S: SHOP SUPPLIES B: BOSS

PART#	CAT	PAGE#	PART#	CAT	PAGE#
Fixed Caster Flat Free	S	31	Grease Hose	L	10
Fluid Suction Gun	L	5	Grease Injectors - 18GA & 21GA	L	9
Fluid Transfer Pump	L	5	Grease Injectors 18GA (3 pcs)	L	18
Forged Aluminum Ball Mount,Drop	T	9	Grease-2-Go! 2-tubes holder	L	19
Forged Chain Swivel	R	10	Green Deep Nut Drive 5/16" x 2.5" long	B	6
Forged Clip	R	13	Grizzly Drill Bit	B	11
Forged D-Ring	R	11	Grommet Assortment	S	6
Forged Steel Ball Mount, Drop	T	8	H.D. Air Hose Reel w/o Hose	S	26
Forged Steel Hitch Pin	R	37	H.D. Auto Rewind Hose Reel	S	26
Forged Turnbuckle Merchandiser 24" x 24"	M	10	H.D. Pneumatic Hand Truck Wheel	S	30
Funnel 2-In-1 Flexible Spout	L	21	H.D. PU Flat Free Hand Truck Wheel	S	30
Funnel Anti-Splash	L	21	H.D. Ratchet Straps,2-Pack Black	C	7
Funnel Filter 100 Mesh	L	22	Hair Pin	R	39
Funnel Foldable	L	21	Hair Pin Assortment	S	2
Funnel HD Flex Spout	L	22	Hair Pin Dynakit	S	9
Funnel Metal Transmission	L	24	Hair Pin Dynapak	R	39
Funnel Multi-Purpose	L	20	Hand Swager	R	16
Funnel Offset Transmission	L	24	Hand Winch	C	12
Funnel Set - 4-pcs	L	20	Hand Winch Auto Brake	C	12
Funnel Set 3pc (4, 5 & 6 in.)	L	20	Handle Kit	L	7
Funnel Tin	L	24	Harness Ring 1-1/4"	R	24
Funnel Tractor	L	24	Heavy Duty 4 Pole Connector	T	17
Funnel Transmission	L	22	Heavy Duty Cutter	B	12
Funnel with Filter	L	20	Heavy Duty Cutter 3/4"	B	13
Funnel without Filter	L	20	Heavy Duty Double Hook Pulley Block	R	19
Funnels & Lubrication - 4'x4'	M	28	Heavy Duty Fixed Eye Pulley Block	R	19
Furnace Chain	R	2	Heavy Duty Grease Coupler NPT	L	18
Fuse Assortment	S	8	Heavy Duty Grease Gun - Lever	L	3
G.A.C 7x19	R	12	Heavy Duty Recovery Strap 2 Ply	C	9
Gate Hook	R	20	Heavy Duty Replacement Pulley	R	20
Genesis Brake Controller	T	21	Heavy Duty Single Hook Pulley Block	R	19
Grade 30 Chain	R	1	Heavy Duty Swivel Eye Pulley Block	R	19
Grade 70 Chain.	R	1	Heavy Duty Tow Rope	C	10
Grade 8 Hitch Pin	R	36	High Speed Trailer Wheel	T	30
Grade 8 Hitch Pin Merchandiser 24" x 24"	M	19	Hitch Adaptor	T	13
Grease Accessories Kit	L	8	Hitch Box Extension	T	12
Grease Accessories Merchandiser 24" x 24"	M	6	Hitch Lock - Bent Pin	T	7
Grease Box	L	19	Hitch Lock - Dual Bent Pin	T	7
Grease Coupler 6000psi 1/8 NPT	L	18	Hitch Lock - Sleeved Barrel	T	7
Grease Coupler 90 Degree	L	9	Hitch Lock Pin	T	6
Grease Coupler Dynapak	L	9	Hitch Pin	R	36
Grease Filler Nipple - Bulk Loader	L	9	Hitch Pin (FOH) Merchandiser 24" x 24"	M	19
Grease Fittings	L	18	Hitch Pin C/W Clip	R	36
Grease Fitting Assortment Kits	S	1	Hitch Pin Merchandiser 24" x 24"	M	20
Grease Fitting Drive-In Dynakit	S	9	Hook Blade 10 pack	B	15
Grease Gun - Lever; and HD	L	3	Hooks Merchandiser 24" x 24"	M	23
Grease Gun - Pistol & Minii Pistol	L	4	Impact Driver Bit Set 18 Pieces	B	9
Grease Gun Holder Bracket	L	8	Impact Round Body	B	1
Grease Gun Pistol C/W Hose	L	4	Impact Zone Display	M	48
Grease Gun Repair Kit 11066	L	4	Industrial Air Hose Reel	S	26

PART#	CAT	PAGE#	PART#	CAT	PAGE#
Industrial Bungee Cord	C	1	Measurer c/w lid & nozzle - 4 litres	L	22
Internal Retainer Ring Dynakit	S	9	Measuring Container - 2.5 L	L	23
Jab Saw, Teflon with Holster	B	18	Measuring Container - 4.5L w/Removable Lid	L	23
Jack Rack Merchandiser	M	32	Measuring Scoop	L	23
Jack Replacement Cap	T	30	Mechanic's LED Penlight	B	16
Jack Stand	S	26	Mega Cutters	B	14
Japanese Metric Kit	S	12	Metal Measurer W/ Flex Spout	L	24
Key Ring	R	24	Metric Grease Fitting Assortment	S	1
Keystock Bin	M	25	Metric Grease Fitting Assortment/Dynapaks	S	9
Keystock Dynakit	S	9	Metric Magnetic Nut 5 Pack	B	8
Lagscrew Eyebolt	R	22	Metric Magnetic Nut Driver	B	6
Large Cotter Pin Assortment	S	4	Mid Link	R	9
Latch Kit	R	6	Mini Bolt Snap 7/16	R	28
LED 3 Watt 3 x AAA Super Bright Cree	B	16	Mini Bungee Cord, Black	C	1
LED Magnetic Towing Light Kit	T	15	Mini Plastic Cutter	B	12
LED Mini Flashlight 2 X AA - Bulk	B	16	Mini Plug In Fuses	S	2
LED with Laser Pointer 3 x AAA 8	B	16	Mini Plug-In Fuses	S	9
Level, Carpenter Pencil with Sharpener	B	21	Missing Link	R	11
Levelling Scissor Jack	T	29	Mounting Tube External	T	30
Lever Action Barrel Pump	L	6	Mud Flap HD	T	31
Lever Action Oil Pump	L	6	Muffler Clamp	R	32
Lever Hoist	S	29	Muffler Clamps Merchandiser	M	18
Lever Snap 1-1/8"	R	30	Multi-Purpose Lithium Grease 14 Oz (10/PKG)	L	2
Lever Snap, Nickel Plated	R	30	Multi-Purpose Lithium Grease 85g (3/PKG)	L	2
Lift Arm Pin	R	42	Multi-Use Ball Mount	T	12
Lifter Coupler Handle	T	5	Multi-use Siphon Pump	L	5
Linch Pin	R	37	Needle Nose Adapter 4"	L	8
Linch Pin Dynapak	R	37	Needle Nose Dispenser 1-1/2"	L	8
Link Lock	R	10	Needle Tip Dispenser	L	8
Load Binder	C	16	Oiler with Nozzle	L	19
Load Binder/Cable Puller Merchandiser	M	50	Open Decoy Snap 1/2	R	29
Load Binder/Cable Puller Rack	M	50	Open Eye Snap 13/16	R	29
Load Tightener	C	16	O-Ring	L	11
Locking Knob Kit	L	7	O-Ring Flange Kit	S	12
Loop Snap 1	R	29	O-Ring Hi Pressure	L	16
Loop Snap 3/4	R	28	O-Ring Hi-Pressure Assortment	S	10
Lubrication 4'x4' Plan-O-Gram	M	27	O-Ring HNBR Assortment	S	4
Lubrication Plan-O-Gram 4' x 4'	M	30	O-Ring Kit Metric	S	13
Lunette Ring - Adjustable	T	14	O-Ring Kit N90 S.A.E.	S	11
Lunette Ring with Base - 3" Channel	T	14	O-Ring Merchandiser 24" x 24"	M	5
Lunette Ring, 2-1/4" dia.	T	14	O-Ring Metric	L	15
Magnetic But Drive Green 5/16" x 2.5" long	B	6	O-Ring Metric Assortment	S	10
Magnetic Insert Holder	B	7	O-Ring S.A.E. Dynakit	S	9
Magnetic Insert Holder with C-ring 60mm	B	6	O-Ring S.A.E. Assortment	S	10
Magnetic Nut Driver	B	6	O-Ring Splicing Kit	S	12
Magnifies	B	19-20	O-Ring V75 (Viton) Assortment	S	11
Magnifier Assortment Countertop Display	M	49	O-Rings Tilt Bin Merchandiser	M	40
Malleable Clip	R	13	Outdoor Hand & Truck Wheel	S	30
Manual Holder	R	42	Over 80" Submersible Trailer	T	15
Master Link Grade 80	R	7			

M: MERCHANDISERS L: LUBRICATION T: TOW-PRO R: CHAIN & RIGGING C: CARGO S: SHOP SUPPLIES B: BOSS

PART#	CAT	PAGE#	PART#	CAT	PAGE#
Padlock Board	M	11	Ratchet Jack	R	41
Padlocks Merchandiser	M	11	Ratchet Load Binder	C	16
Panic Snap 1/2	R	28	Ratchet Rope Tie-Down	C	5
Passing Link Chain	R	2	Ratchet Set 16 Pieces	B	10
Phillips	B	2	Ratchet Strap	C	7-8
Pins Merchandiser 24" x 24"	M	16	Razor Folding Knife	B	14
Pintle Combination Hitch	T	14	Receiver Tube	T	13
Pintle Hook	T	13-14	Recessed Anchor; HD	C	15
Pintle Hook w/shank	T	13	Rechargeable Battery	L	2
Pintle Mount	T	14	Rechargeable Grease Gun Kit	L	1
Plain Trolley	S	28	Recovery Strap	C	9
Plastic Bin Blue	M	45	Rect. Keystock Merchandiser	M	25
Plastic Cap	T	30	Rectangular Keystock	S	13
Plastic Funnel Merchandiser	M	29	Red Deep Nut Drive 3/8"x2.5" long	B	6
Plastic Standard Cutter	B	12	Reel Display Shelf	M	49
Plastic Super Funnel 5" Diameter	L	22	Regulator Kit	L	7
Plastic Wheel Chock	T	31	Repair Kit	R	8
Plug In Fuses	S	2	Repair Link	R	10
Pneumatic Barrow Wheel	S	30	Replacement Ball	T	14
Pneumatic Hand Truck Wheel	S	32	Replacement Battery Charger	L	2
Pneumatic Outdoor & Hand Truck Wheel	S	32	Replacement Grease Gun Pipe 5-1/2	L	10
Pneumatic Wheel	S	30	Replacement Grease Hose - 30"	L	2
Pneumatic Wheel Barrow Wheel	S	30	Replacement Hose for 11025	L	2
Pop Up Anchor Point	C	15	Replacement Latch Kit	R	7
Portable Electric Winch 12V	C	13	Retail Packaged Pull Pin	T	7
Portable Fluid Pump	L	6	Retainer Ring External	S	25
Portable Measurer c/w Hose	L	23	Retainer Ring External	S	23
Power Jack - 3000lbs, 12V, 18" Stroke Distance	T	25	Retainer Ring Internal	S	24
Premium Bungee Cord	C	1	Retainer Rings Merchandiser 24" x 24"	M	9
Premium Bungee Pack 15 Pc Assortment	C	2	Retainer Rings Tilt Bin Merchandiser	M	41
Pro Carpenter Pencil Sharpener	B	21	Retractable Tie Down	C	8
Professional Assortment Bits and Nut Drives	B	9	Retractable Utility Metal Cutter	B	12
Professional Pistol Grease Gun	L	4	Reversible Ball Mount, Dual	T	10
PU Flat Free Hand Truck Wheel	S	32	Ring & Eyebolt	R	23
PU Flat Free Outdoor & Hand Truck Wheel	S	32	Ring & Lagscrew Eyebolt	R	23
PU Flat Free Wheel	S	32	Ring & Mounting Plate	R	23
PU Flat Free Wheel Barrow Wheel	S	30	Rivet Hardware Assortment	S	8
Pull Pin & Stainless Steel	T	7	Robertson Impact Bit Colored Band	B	1
Pulley Block Double	S	28	Rotary Barrel Pump	L	6
Pulley Block Single	S	28	Rotating Recessed DRing Anchor	C	15
Pulley Blocks Merchandiser 24" x 24"	M	15	Round Tube Implement Jack 2000lb, 10" Lift	T	27
Pulley Single/Double Fixed	R	18	Rubber Handgrip Side Wind Jack	T	30
Pump Oiler	L	19	Rubber Sealing Washer Assortment	S	8
Quick Change Adapter 1/4"	B	7	S.A.E. Grease Fitting Assortment	S	1
Quick Link	R	11	S.A.E. Grease Fitting Dynakit	S	9
Quick Pin; Dynapak	R	38	S.S Boat Snap 19 x 98	R	27
Quick Release Bit Holder	B	7	S2 Torque	B	3
Quick Release Pin	R	34	S2 Clutch	B	5
QuikConnect OEM Wiring Harness	T	22-23	S2 Drywall Phillips	B	4
Ratchet Binder	C	16	S2 Hex/Allan	B	4

PART#	CAT	PAGE#	PART#	CAT	PAGE#
S2 Phillips	B	2	Snaps Merchandiser 24" x 24"	M	11-12
S2 Pozi	B	4	Snatch Block	S	28
S2 Slotted	B	2	Socket Adaptor Set 3 Pack 1/4" Hex/Allan Shank	B	10
S2 Square	B	1	Socket Holder	B	6
SAE Double Magnet Tape Measure 2 Sided	B	18	Socket Set Screw Assortment	S	2
SAE Grease Fitting Assortment	S	9	Soft Grip Ratchet Strap J-Hook; S Hook	C	8
Safety Blade Utility	B	15	Solid Brass Bolt Snap 1/2" x 3	R	29
Safety Cutter Comfort design blade	B	14	Solid Snap Hook	R	27
Safety Lanyard Hook Single Latch	R	27	Spanner	B	5
Safety Pin	R	34	Spring Assortment	S	3
Safety Slip Hook	R	6	Spring Barrel Compression	S	16
Safety Winch Hook	R	6	Spring Compression	S	16-21
Samurai Blade Heavy Duty	B	15	Spring Display 24" x 24" (2) 200-1	M	7
Samurai Mega Blade	B	15	Spring Display Merchandiser 24" x 24"	M	8
Sash Chain	R	2	Spring Drawbar	S	21
Saw Blade Overtime	B	21	Spring Extension	S	16-20
Scraper Retractable ABS Plastic	B	12	Spring Latch - "L Handle"	T	7
Scraper Retractable Cutter ABS Plastic	B	12	Spring Latch - Loop Handle	T	7
Scraper Retractable Plastic	B	12	Spring Lock Pin	R	37
Screw Eye	R	21	Spring Pin Dynakit	S	9
Screw Hook	R	21	Spring Torsion	S	16
Screw Pin Anchor Shackle	R	8	Springs Board A&B 24" x 24"	M	7
Screw Pin Chain Shackle	R	9	Springs Cabinet Bulk	M	8
Seal Off Adapter	L	9	Springs Merchandiser Board & 24" x 24" Bulk	M	8
Sealable Drain Pan - 10L	L	25	Square	B	1
Security Snaps	R	30	Square Keystock	S	13
Self Lock Swivel Eye Hook Grade 80	R	8	Square Keystock Merchandiser	M	25
Self Locking Clevis Hook Grade 80	R	8	Square Trigger Snap 3/4	R	28
Self-Priming Copper Pump	L	5	Square Tube "Simol" Jack	T	29
Semi Pneumatic Wheel	S	30	Square Tube Side Wind & Top Wind Jacks	T	29
Serrated Blade Heavy Duty	B	15	Square U-Bolt	R	23
Shackle Ball Mount & Solid Shank	T	11	Stabilizer Jack, 650lbs	T	29
Shackles/Clevises Merchandiser 24" x 24"	M	23	Stackable Chain Pail Display	M	43
Sheave	R	19	Stainless Steel Boat Snap	R	27
S-Hook	R	20	Stainless Steel Merchandiser 24" x 24", 12"x24"	M	21
Shoulder Eyebolt	R	22	Stainless Steel Quick Link	R	11
Side Wind Handle	T	30	Stainless Steel Security Snap	R	27
Side Wind Implement Jack	T	27	Stainless Steel Shackl	R	9
Side Wind Jack Handle	T	30	Stainless Steel Snap Link	R	31
Side Wind Jack w/caster wheel	T	25	Stainless Steel Thimble	R	14
Simplex Snap	R	31	Stainless Steel Wire Rope Clip	R	14
Single Jack Chain	R	3	Stake Rack Eye, Hook	R	20
Siphon Hose Pump	L	5	Standard Driver Bit Display	M	46
Small base for 11492	T	26	Standard Plug-In Fuses	S	9
Small Wheel Merchandiser	M	44	Steel Cable Rack Merchandiser	M	43
Snap Hook Aluminum	R	31	Steel Cold Shut	R	10
Snap Link	R	31	Steel Ring	R	24
Snap Spring	R	30	Step Bumper	T	12
Snap Stainless Steel Spring	R	27	Step Keystock	S	13
Snap, Swivel Simplex Spring	R	31	Step Keystock Merchandiser	M	25

M: MERCHANDISERS L: LUBRICATION T: TOW-PRO R: CHAIN & RIGGING C: CARGO S: SHOP SUPPLIES B: BOSS

PART#	CAT	PAGE#	PART#	CAT	PAGE#
Stop	R	15	Transport Chain Gr70	R	3
Straight Bar Ball Mount	T	8	Trigger Snap	R	28
Straight Clevis	R	33	Triple Ball Mnt Hollow-Square	T	11
Straight Link Coil Ch. #4x100'	R	1	Triple Ball Mount	T	11
Stroke Control	R	33	Triple Ball Mount /W Tow Hook	T	11
Stroke Control Merchandiser	M	24	Triple Ball Mount, Round	T	10
Surface Mount Anchor	C	15	Triwing	B	5
Swing-Way Boat Jack	T	25	Truck and Trailer Wheel Pan	L	25
Swivel Caster; with Brake; 10"	S	31	Tube Mount Side Wind Jack	T	28
Swivel Eye Hook	R	6	Turnbuckles	R	24-26
Swivel Eye Snap	R	30	Turnbuckle Merchandiser 12" x 24"	M	10
Swivel Loop Snap	R	29	Twist Link Mach. Chain	R	2
Swivel Snap	R	30	U-Bolt	R	23
Synchronizer Brake Controller	T	21	U-Bolts Merchandiser 24" x 24"	M	14
Tab Quick Pin Round	R	38	Ultimate Bungee Cord - Adjustable	C	1
Tamper Proof Torque	B	5	Universal Board and Hooks 24" x 24", 12"x24"	M	25
Tape Measure Nylon Coat SAE	B	18	Universal Clevis Pin	S	14
Tape Measure SAE/Metric	B	18	Universal Tail Pipe Hanger	R	32
Tarp Hook	R	21	Universal Trailer Coupler Lock	T	6
Tarp Strap Adjustable ; HD	C	5	Used Fluid Drainer 68L	L	7
Thimble; HD	R	14	Utility Cutter Metal Retractable	B	12
Tilt Bin	M	44	Utility Pin	S	14
Tire Chain	R	16	Vari-Speed Pulley	R	17
Tire Chain Plier 32in.	R	16	Waterproof Padlock	B	17
Top Hook Replacement	S	29	Weather Cap	R	32
Top Link; and Bushings	R	41	Weathercaps Merchandiser 24" x 24"	M	14
Top Link Pin	R	42	Welded Steel Ball Mount,Drop	T	8
Top Wind Handle	T	30	Weld-On Mounting Bracket	T	30
Top Wind Implement Jack	T	27	Wheel Chock	T	31
Tow Rope	C	10	Wheel Kit	L	7
Tow Strap	C	9	Wheel Lock	T	31
TowPro Trailer Connectors	M	34	Wheel Merchandiser	M	45
TowPro Trailer Connectors-4'x4 Overlay	M	34	Wheel Rack - No Product	M	45
Tractor Drawbar Hook	R	33	Wheel Spinner	R	33
Tractor Linkage Merchandiser 12" x 24"	M	17	Winch Bar Type	C	11
Trailer Coupler A-Frame Forged	T	3	Winch Repair Kit	C	14
Trailer & Towing - 4'x4'	M	31	Winch Straps	C	11
Trailer & Towing Plan-O-Gram 4' x 4'	M	32	Wire Connectors Assortment	S	6
Trailer Ball External Thread	T	1	Wire Rope	R	12
Trailer Ball External Thread Pkgd	T	2	Wire Rope Accessories Merchandiser 12" x 24"	M	20-22
Trailer Ball HD	T	2	Wire Terminal Assortment	S	5
Trailer Ball Internal Thread	T	1	Woodruff Key Assortment	S	7
Trailer Ball Long External Pkgd	T	2	Woodruff Key Dynakit	S	9
Trailer Ball Reducer Bushing	T	2	Worm Gear Winch	C	13
Trailer Balls Merchandiser 12" x 24"	M	2	Yellow Tarp Strap HD	C	4
Trailer Connectors	T	17-21	Zinc Swivel Snap	R	30
Trailer Coupler	T	3			
Trailer Couplers Merchandiser 24" x 24"	M	2			
Trailer Lock Kit	T	6			

AUTHORIZED DYNALINE DISTRIBUTOR:

QR code reader required



DYNALINE INDUSTRIES INC.

18070 - 109 Avenue NW Edmonton, Alberta
Tel: 780-453-3964 • Toll Free: 1-877-453-3964
Fax: 780-453-5040 • Toll Free: 1-877-453-5050
E-mail: mail@dynaline.com
Web: www.dynaline.com



Canadian-owned
Established in 1988



ISO 9001:2008
Quality Management System
CERT-0050960

