

NORTECH

INNOVATIVE PRODUCTS

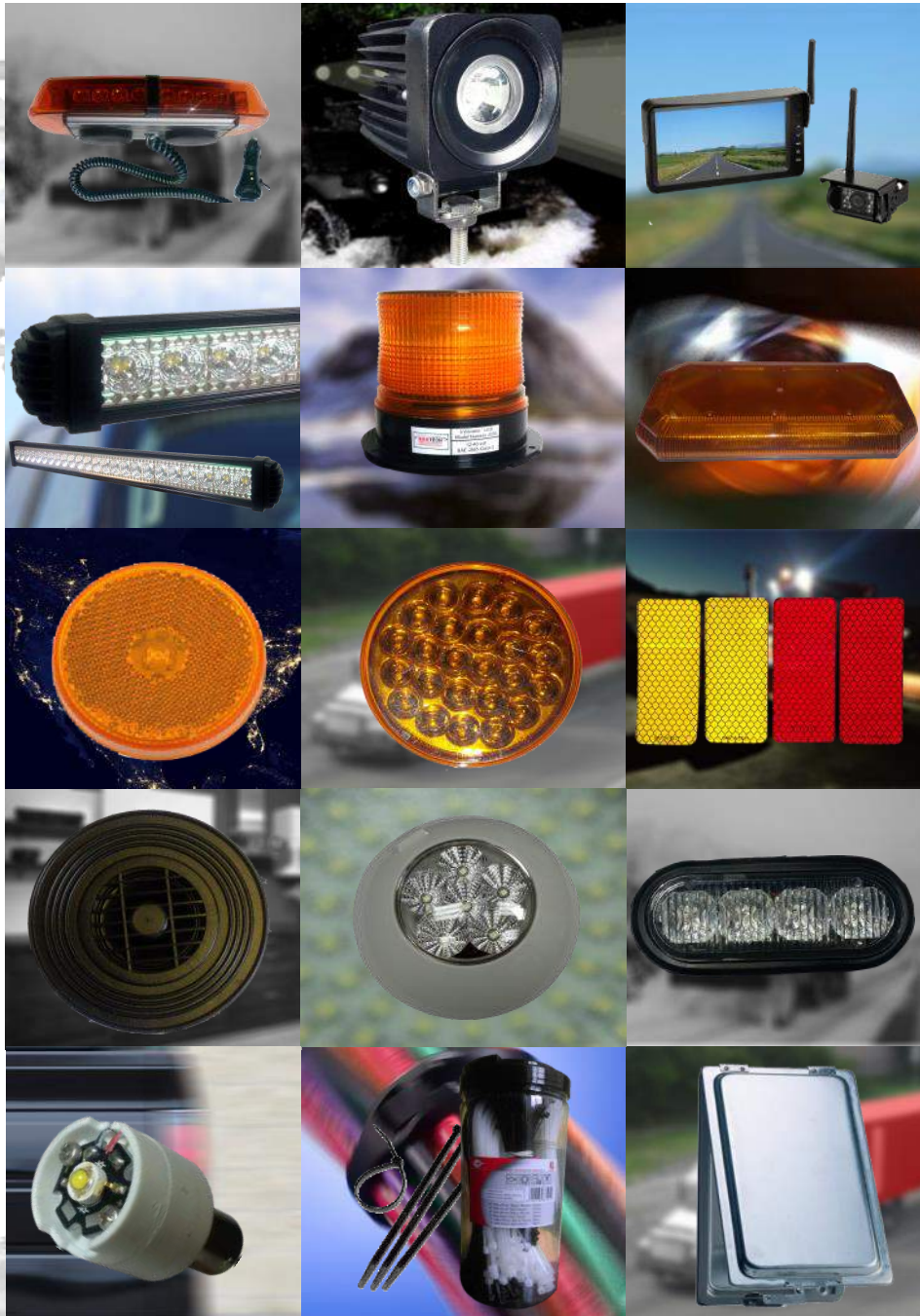

LED LIGHTING SOLUTIONS



CATALOGUE SUPPLEMENT 415



Our Mission:

To develop and design innovative, energy efficient and cost effective lighting solutions for the automotive, heavy duty truck & trailer, agricultural, and commercial marketplaces.

Industry Experienced Technical Sales Team:

Nortech has an experienced and highly-qualified Technical Sales Team. We approach a challenge with great creativity and research, resulting in the design and development of innovative new products.

Global R&D Team:

The Nortech team has decades of experience in the transportation industry and specialize in LED lighting research and development. These experts are involved in the R&D for Nortech's products and provide the engineering and technical support required to manufacture the high quality, long lasting products that our customers demand.

Independent Lab Recognition:

All Nortech products undergo extensive lab, pre-production and on-going quality testing. Where required, our products meet or exceed SAE, CUL or cELT standards. In addition to factory and in-house testing our products are subject to extensive field testing before being released to the market.

Quality Commitment:

Nortech Innovative Products is committed to supply innovative products that exceed our customer's expectations for quality, durability, serviceability and value. Customer satisfaction is the foundation of our business.



CRYSTAL BURST OPTICS (CBO)

Creates a burst pattern in the lens designed to disperse light more efficiently creating more intense visible light.



SKYWARD OPTICS

Carefully positioned LEDs at the top of a beacon so more light is emitted, increasing visibility

PLUG & PLAY

Field repairable by replacing a LED light module.



VU PACK—Nortech display packaging



cULus—Tested to Canadian and US standards by Underwriters' Laboratories



SAE— Society of Automotive Engineers standards

IP— Ingress Protection rating



RoHS— Restriction of Hazardous Substances Directive



DLC— Design Lights Consortium®

cELTus—approved by European Test Labs to CSA and UL standards



A **linear LED** tube lined with LED diodes when activated produce a

strobing effect through the LED tube increasing visibility and intensity of the light

Meets **FMVSS 108**

Federal Motor Vehicle Safety Standard 108 (FMVSS108) regulates the automotive lighting, signaling and reflective devices in the United States.

DOT COMPLIANT

Meets or exceeds Department of Transportation safety standards.

SAE back-up alarm ratings

CLASS	SOUND LEVEL (dcb) J944
A	112
B	107
C	97
D	87
E	77
F	other

SAE Class	Description
Class 1	Standard used for clearing
Class 2	Standard used for blocking traffic (vehicle is stopped and blocking lane)
Class 3	Identification only



CONTENTS

1. LED Mini Light Bars + Rotating Beacons	3—5
2. LED Full Size Light Bars	5—6
3. LED Traffic Arrows and LED Arrow Stick (Nortech 'Nindicator')	7
4. LED Beacons	8—10
5. Window + Dash mount warning products and LED Accessories	11
6. LED Safety Flares and Puck lights	12
7. LED Perimeter Lighting, Light heads , and 'Sneak a Strobing LED'	13—14
8. 'Evolutione' Series Work Light + Work Light Bars	15—22
9. LED Indicator Light Bars	23
10. Driving lights	24
11. Mounting Accessories and Installation Hardware	25
12. LED Work Lights	26—27
13. LED Head Lamps Conversion Kits	28
14. Automotive Fuses	26
15. Back-up Alarms and Back-up Warning Bar	29—30
16. Rear-View Camera Systems	31—33
17. OEM "Exact Fit" Program	34
18. Conspicuity Tape	35—36
19. LED Mini Bulbs	37—38
20. Cats Eye Series	39—40
21. Clearance and Marker Lamps	41—44
22. Incandescent Vehicle lighting	45
23. Interior Courtesy & Dome lights	46
24. Document Holders	47
25. Cable Ties	48
Commercial Lighting Products	
26. LED Strip and Rope Lighting	49
27. Viking Rigid Bars	50
28. Viking Modules and Flood Lights	51
29. Rechargeable Work Lights, Flood Lights, and Tripod	52
30. Flood Lights and High Bay Lights	53
31. Wall Packs, Retro Fit kits, Street Lights, Canopy, and Shoe box lights	54
32. SMART LED Touch Light and LED Pot Light	55
33. Par Lights, LED BR Lights, Tube Lights, and Panel Lights	56
34. Index	57—58



LED MINI LIGHT BARS



2512A

2512MA

2512B

2512MB

2512CAA-S

2512MCAAS



2512A

Aluminum Base



TURBO II with CONTROL SWITCH						
Compact 24—1 Watt Gen III LEDs. Polycarbonate lens with aluminum base. Circuit board and electronic components are coated to protect from the environment. 2512A and 2512 MA features 6 flash patterns; wig-wag, quad flash, front/back/all flash, chase, constant flash, front/back/ front side flash.						
P/N	DESCRIPTION	AMPS	WATT	VOLTAGE	CTN	
2512A	Permanent Mount. Amber LEDs and Clear outside Lens	2.5	24W	DC 12V-24V	12	
2512B	Permanent Mount. Blue LEDs and Clear outside Lens	2.5	24W	DC 12V-24V	12	
2512MA	Magnetic Mount with car adapter plug and cable. Amber LEDs and Clear outside Lens	2.5	24W	DC 12V-24V	12	
2512MB	Magnetic Mount with car adapter plug and cable. Blue LEDs and Clear outside Lens	2.5	24W	DC 12V-24V	12	
TURBO II no switch						
3 continuous repetitive flash patterns. Right wig-wag, quad flash, left wig-wag.						
2512CAA-S	Permanent Mount . Clear LEDs and Clear outside lens. Hard wired.	2.5	24W	DC 12V-24V	12	
2512MCAAS	Magnetic Mount Clear LEDs and Clear outside Lens with cord and car adapter plug.	2.5	24W	DC 12V-24V	12	



Control switch to change flash patterns

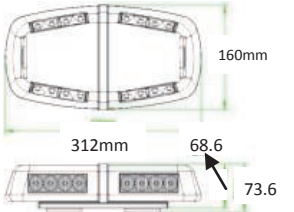

SAE CLASS 1



2512MA

2512MG



Aluminum Base

Magnetic mount

TURBO ECONOMY MAGNETIC MOUNT 12" LED MINI BAR						
<ul style="list-style-type: none"> Compact 24—1 Watt Gen III LED mini-bar. Amber lens with Magnetic base and car adapter plug. Features 8 flash patterns, SAE J84 Class 2 						
P/N	COLOUR; MOUNT	AMPS	WATTS	VOLTAGE	CTN	
2512MAA	Amber lens; Magnetic mount	2	24W	DC 12V	12	
2512MG	Green LEDs; Green Lens, Magnetic mount. For volunteer firefighters.	2	24W	DC 12V	12	

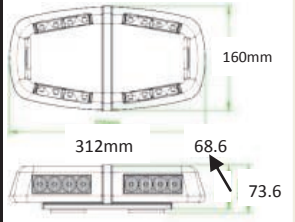

SAE CLASS 2



2612A

2612MA



Control Box

"BADGER" LED MINI LIGHT BAR (CLASS 1)						
<ul style="list-style-type: none"> The Badger is a powerful 11" light bar that uses linear LEDs to produce a higher intensity light output. Linear LEDs disperse the LED light around strobe like tubes creating greater visibility and intensity. Made with Polycarbonate Lens & base for strength. Houses 36 linear LEDs to produce Badger like intensity. SAE Class 1, J845, title 13. Amber LED clear lens 						
P/N	COLOUR; MOUNT	AMPS	WATTS	VOLTAGE	CTN	
2612A	Amber; Permanent mount	2.2	36W	DC 12V	12	
2612MA	Amber; Magnetic mount	2.2	36W	DC 12V	12	



SAE CLASS 1

LED MINI LIGHT BARS



linear LED

2616AA



2616CA

2616MAA

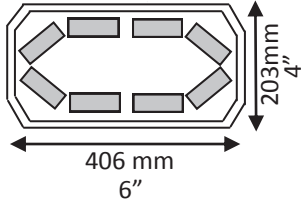

2616MCA



CRYSTAL BURST OPTICS

SAE CLASS 1

16" "NORDIC CAT" MINI LIGHT BAR (SAE CLASS 1, J845, ECE, TITLE 13)

- Sleek and powerful 16" Nordic Cat features Nortech's crystal burst optics in a linear tube.
- Features 17 flash patterns that can be selected on permanent mount version by touching the yellow wire to the red wire.
- Strong Polycarbonate base and lens, is weather proof, with weather insulated circuit board.
- The Nordic Cat brings you a SAE class 1 premium light bar designed for long life, reliable performance and ease of operation and serviceability

P/N	TYPE	AMPS	WATTS	VOLTAGE	CTN
2616AA	Permanent Mount. Amber lens, amber LEDs	3.2Amps	48W	12V-24V	6
2616CA	Permanent Mount. Clear lens, amber LEDs	3.2Amps	48W	12V-24V	6
2616MAA	Magnetic Mount with car adapter plug. Amber lens, amber LEDs	3.2Amps	48W	12V-24V	6
2616MCA	Magnetic Mount with car adapter plug. Clear lens, amber LEDs	3.2Amps	48W	12V-24V	6

5124A



5124MA



PLUG & PLAY

SAE CLASS 1

"ULTRA THIN" LOW PROFILE 24" LED MINI LIGHT BAR SAE CLASS 1, J845, TITLE 13

- Low profile "ultra thin" polycarbonate LED light bar
- Perfect for tow trucks, utility, security, supervisory and construction vehicles and work trucks
- Circuit board and electronic components are coated to protect from the environment.
- LEDs are plug & play making them field repairable and easy to replace
- Incorporates 1 watt gen III LEDs, low power consumption, SAE Class 1
- Includes control box with the capability to switch between 12 flash patterns
- Built in directional arrow left and right traffic indicator patterns.
- 12 modules (4 SMD chips per module)

P/N	TYPE	AMPS	WATTS	VOLTAGE	CTN
5124A	Amber LED (Permanent Mount); 12 modules	3.1	40W	DC 12V	6
5124MA	Amber LED (Magnetic Mount); 12 modules	3.1	40W	DC 12V	6

5524A

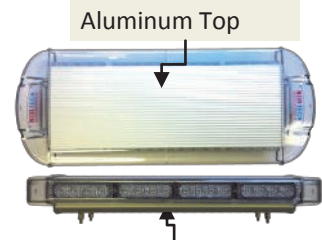

5524MA

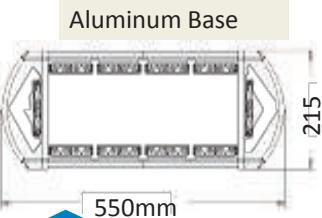

SAE CLASS 1

"NORDIC WOLF" 21.5" LED MINI LIGHT BAR

- Strong, sleek and powerful "I" beam frame with aluminum top and bottom, polycarbonate side lens construction, 21.5" x 8.5" wide
- Universal usage for all vehicles featuring long life gen III LEDs on front and back. Linear LEDs on both sides, SAE Class 1, J845, Title 13
- Circuit board and electronic components are coated to protect from moisture and shock. LEDs are Plug & Play making them field repairable and easy to replace
- Available in both permanent mount versions (5524A) and magnetic mount versions (5524MA) with 12 Flash patterns
- Includes control box with built in directional left and right traffic indicator patterns.
- 10 modules (4 SMD chips per module)

P/N	TYPE	AMPS	WATTS	VOLTAGE	CTN
5524A	Amber LED (Permanent Mount)	3.2	44W	DC 12V	1
5524MA	Amber LED (Magnetic Mount)	3.2	44W	DC 12V	1



Plug & Play: LEDs are field repairable by simply taking the old LEDs out and replacing them with new LEDs

2115A

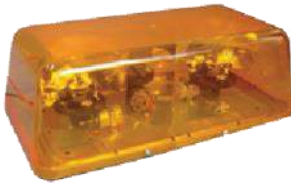

SAE CLASS 1

15" ROTATING LIGHT BAR

- Compact design 15" mini light bar, with flush aluminum base
- Features 2 halogen rotating lights and a diamond-shaped mirror
- Available with a flush base and optional magnetic mounting kit
- Powerful 80,000 candles, 95 FPM (+/-)
- Meets class 1 requirements

P/N	TYPE	VOLTAGE	AMP	CTN
2115A	Rotating light bar	12V	4.8	6

2160



SAE CLASS 2

360 DEGREE DUAL STROBING LED MINI-BAR

- Features two super-powered LED 360 degree strobes
- Compact, light weight, diamond-shaped mirror, combined with a low amperage draw
- Magnetic mounting kit available
- Extreme version available using Ultra LEDs. Add an "X" to model number [eg, 2160XA]

P/N	TYPE	VOLTAGE	AMP	CTN
2160	LED	12V	1.8	6

5024A



5048A

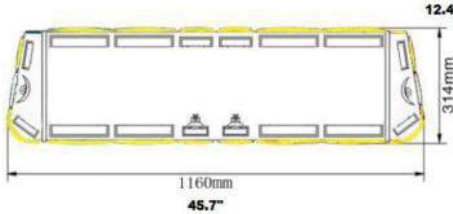

5060A

SAE CLASS 1

HEAVY DUTY I BEAM LIGHT BAR

- Heavy duty extruded "I" beam die cast aluminum base & top is great for extreme conditions
- High powered LEDs are rated for over 100,000 hours
- Circuit board and electronic components are coated to protect from the environment
- Lenses are polycarbonate

P/N	TYPE	VOLTAGE	AMP	CTN
5024A	24" (60.9cm); Amber led	12V	2.43	1
5048A	48" (121.9 cm); Amber led	12V	4.85	1
5060A	60" (152.4 cm); Amber led	12V	6.7	1

5148A



5148A-AL

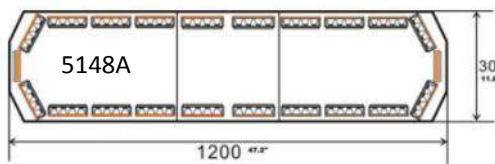

5160A

5160A-AL

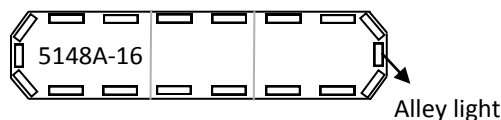

SAE CLASS 1

"ULTRA THIN" LED LIGHT BAR

- Our "Ultra-Thin" series incorporates super LEDs, low power consumption and multiple flash patterns
- Low-profile ultra thin polycarbonate LED light bar
- Perfect for tow trucks, police, utility, security, supervisory and construction vehicles
- Circuit board and electronic components are coated to protect from the environment
- Includes control box

P/N	TYPE	VOLTAGE	AMP	CTN
5148A	48" (122 cm); Amber led—22 LED modules	12	4.85	1
5148A-AL	48" (122 cm); Amber led 16 LED modules with 2 alley lights on each end	12	5.55	1
5160A	60" (153 cm); Amber led—26 LED modules	12	6.70	1
5160A-AL	60" (153 cm); Amber led 20 LED modules with 2 alley lights on each end	12	7.20	1



5548A



5560A



Linear module



“NORDIC WOLF” FULL SIZE LED LIGHT BAR

- Strong, sleek and powerful, features the unique combination of an aluminum “I” beam construction for strength, combined with the good looks and thinness of a low-profile polycarbonate bar
- Heavy duty extruded aluminum “I” beam frame with polycarbonate side lens construction
- Universal usage for all vehicles featuring long life, linear LEDs with multiple flash patterns.
- Circuit board and electronic components are coated to protect from moisture. Includes control box.

P/N	TYPE	Voltage	Amp	CTN
5548A	48” (121.9 cm); 18 modules; Amber led	12V	4.80	1
5560A	60” (152.4 cm); 22 modules; Amber led	12V	6.70	1

5441A



5449A



ALUMINUM BODY

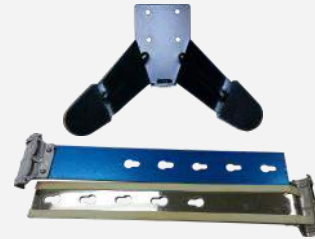

CONTROL BOX

5459A



GEN 3.5 LEDs

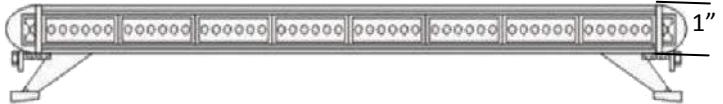

WARNING LIGHT BAR
ALUMINUM
ULTRA SLIM
TOW MAN'S BAR



5459A

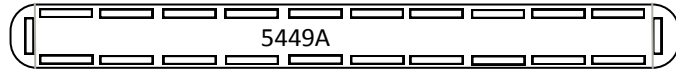

5449A

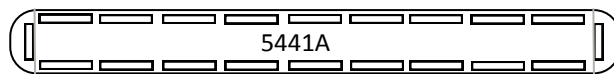

5441A



“TOW MAN’S” LED WARNING LIGHT BAR

- Multiple flash patterns and built-in amber arrow stick with 8 patterns
- Tough I beam construction with aluminum top and base
- Gen 3.5 LED modules
- Clear outside Polycarbonate lens, clear internal lens Amber LEDs
- Features: LED stop, tail, turn
- Ultra slim profile 1” bar; 2.5” with mounting hardware with adjustable legs
- Includes control box pre-wired

P/N	SIZE	VOLTAGE	WATTS	CTN
5441A	41” x 3.5 “x 1” - 18 modules (4 led s in one module)	12V or 24V	102x1W	3
5449A	49” x 3.5 “x 1” - 22 modules (6 led s in one module)	12V or 24V	126x1W	3
5459A	59” x 3.5 “x 1” - 26 modules (6 led s in one module)	12V or 24V	150x1W	3

TOW MAN'S BAR



6748

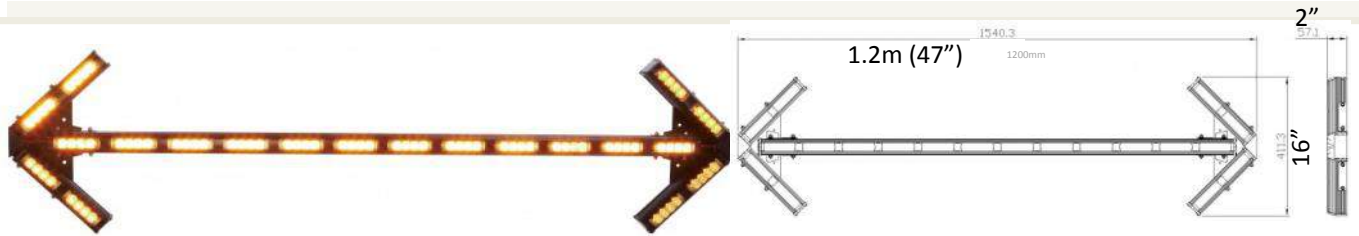

INDICATOR LED ARROW STICK (SAE Class1; CA13)

- All connections have been sealed to make them water proof and weather proof
- SAE class 1 and CA title XIII, ECE requirements
- Aluminum housing, powerful Gen 3 lighting
- 6 flash patterns: All flash, left, right, split, both simultaneously and alternating
- Control box included
- *1.6m (63") available on special order. Order part number 6763

P/N	COLOUR	TYPE	VOLTAGE	AMPS	CTN
6748	Amber; 1.2m (47")	Directional Arrow	12V—24V	3.7Amps	1

6750



INDICATOR LED TRAFFIC ARROW (SAE Class 1)

- All connections have been sealed to make them water proof and weather proof.
- Aluminum body to withstand harsh weather and corrosion.
- Waterproof twist to lock connections.
- Comes with a full control box (not a switch) which allows the user to turn on/off and select through various patterns: left arrow, right arrow, alternating, all flash, left sequential, right sequential.
- 50" arrow with mounting hardware included

P/N	COLOUR	TYPE	VOLTAGE	AMPS	CTN
6750	Amber	Traffic Arrow	12V—24V	3.5 Amps	1

6804A



INDICATOR LED TRAFFIC DIRECTOR/ WARNING STICK

- High output directional warning light features low amp draw and maintenance-free
- Features multiple flash patterns: left arrow, right arrow, alternating, all flash, left sequential, right sequential.
- Weather-sealed for internal or external mounting. Pairs may be synchronized with each other.
- Ideal for municipalities, towing, utility, police and construction vehicles. Includes control switch.

P/N	COLOUR	TYPE	VOLTAGE	AMPS	LENGTH	CTN
6804A	Amber LED module	Traffic Arrow	12V	0.8A	19"	2
6806A	Amber LED module	Traffic Arrow	12V	1.2A	28"	2
6808A	Amber LED module	Traffic Arrow	12V	1.6A	36"	2
6810A	Amber LED module	Traffic Arrow	12V	2.0A	45"	2

6810A

LED BEACONS

1325A

1325B

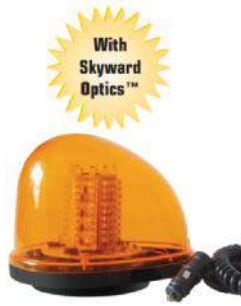

SAE CLASS 3

"KO-JACK" MAGNETIC MOUNT DUAL-FUNCTION LED BEACON

- Dual-function LED beacon with the option of a LED strobe beacon or a rotating LED beacon
- 12 volt compact design, magnetic mount with 8ft /243.8cm car adapter plug with switch
- New Skyward Optics™ provides greater visibility
- 100,000 hour draw less than .5amps, never replace a bulb again

P/N	COLOUR	VOLTAGE	AMPS	CTN
1325A	Amber	12V	0.5A	6 or 12
1325B	Blue	12V	0.5A	6 or 12

*Green and Red available on special order

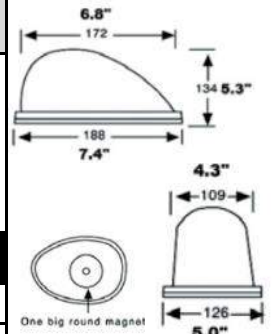

1375A

1375B



SAE CLASS 3

MAGNETIC MOUNT 2 IN 1 LED BEACON

- Compact design, dual function LED provides the instant option of a LED strobe beacon or a rotating LED beacon with the flick of the switch
- Switch is mounted on the 8ft /243.8cm car adapter plug
- Features Skyward Optics™ for increased visibility
- Popular 12 volt design, 100,000 hour LEDs, never replace a bulb again
- Draws less than .5 amps

P/N	COLOUR	VOLTAGE	AMPS	CTN
1375A	Amber	12V	0.5A	6 or 12
1375B	Blue	12V	0.5A	6 or 12

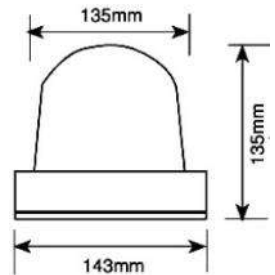

1452A

1452HDA

1452HDMA



INDUSTRIAL-STYLE LED STROBE BEACON (SAE, E13, CE)

- Industrial-style strobe beacon great for lift trucks, and construction equipment
- Re-enforced nylon base and polycarbonate lens seals out environmental hazards
- Multi-voltage 12-80V; reverse polarity and voltage spike protected
- Draws .14 amps at 12 volts., and .45 amps at 80 volts
- 1452HDA offers 80 quad flashes per minute;
- 1452A offers 4 flash patterns; single, double, continuous, rotating

P/N	TYPE	CLASS	VOLTAGE	CTN
1452A	Amber; Permanent mount 4FP	Class 3	DC 12V-80V	24
1452HDA	Heavy Duty; Amber; Permanent mount, potted	Class 2	DC 12V-80V	24
1452HDMA	Heavy Duty; Amber; Magnetic mount, potted	Class 2	DC 12V-80V	24

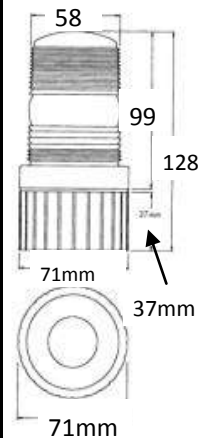

1455A

1455MA



* Also available in blue, clear and red

SAE CLASS 3

"SUPERBOLT LED"™ LED BEACON (SAE CLASS 3)

- Compact permanent mount 4X flash LED beacon with ABS base with mounting flange and polycarbonate lens
- Rivals a class 3 strobe and lasts 50 times longer than a strobe tube
- Automatically adjusts from 12-30 volt, 360 degree LED beacon, 30 diodes
- Meets SAE class 3 requirements

P/N	COLOUR	MOUNT TYPE	VOLTAGE	AMPS	CTN
1455A	Amber	Permanent	12V-30V	0.45A	20
1455MA	Amber	Magnetic	12V-30V	0.45A	20

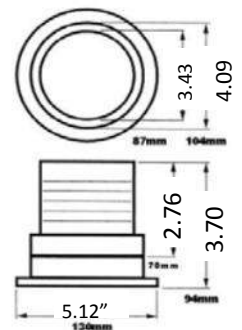

4250A



SAE CLASS 2

DIECAST ALUMINUM BASE MED PROFILE LED BEACON (SAE Class 2)

- Die-cast aluminum base with flange and a pipe-mount mounting options.
- Weather encapsulated Circuit board is coated for weather and vibration resistance to ensure longer life.
- 4 flash user selectable patterns: single, double, quad and rotating pattern
- Class 2 multi-voltage 12-48 Volt, draws a maximum of .7 amps.

P/N	COLOUR	TYPE	VOLTAGE	AMPS	CTN
4250A	Amber	LED Strobe Beacon	12V-48V	0.8A	6

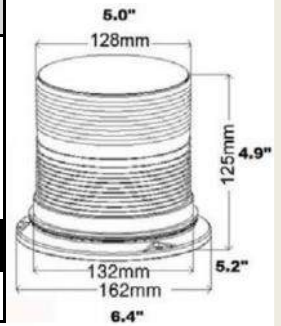

4518A



SAE CLASS 1

UNIVERSAL MOUNT LED STROBE LIGHT

- Universal mount, 2-hole high energy LED strobe light
- Re-enforced nylon base with fully encapsulated components and polycarbonate lens seals out environmental hazards
- Size: 136.5mm [L] x 57.5mm [W] x 66.5mm [H]
- Multi-voltage 12-80 volt 80 quad flashes per minute
- Reverse polarity and voltage spike protected

P/N	COLOUR	VOLTAGE	AMPS	CTN
4518A	Amber	12V-80V	0.045A @ 80V; 0.14A @ 12V	12

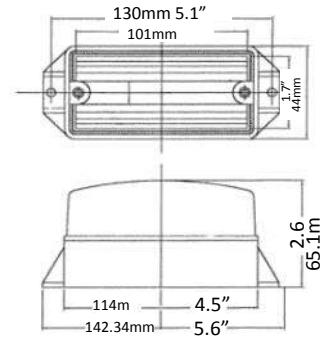

4555A



SAE CLASS 2

INNOVATOR™ HIGH-PROFILE LED BEACON (SAE Class 2)

- Our most popular multi-voltage model for work truck, utility, municipal and construction fleets
- New innovative polycarbonate base features both flange mount and pipe mount
- No EMI radiation
- Polycarbonate lens with our innovative flat-style o-ring and a fully potted circuit board makes a 100% true weather tight seal
- Selectable 4 flash patterns; single, double, quad and rotating pattern.

P/N	COLOUR	VOLTAGE	AMPS	CTN
4555A	Amber	DC 12V-48V	0.9A	6
4555B	Blue	DC 12V-48V	0.9A	6
4555C	Clear lens; Clear LEDs	DC 12V-48V	0.9A	6
4555CA	Clear lens, amber LEDs	DC 12V-48V	0.9A	6



4650A



SAE CLASS 1

LOW-PROFILE HIGH INTENSITY LED BEACON (SAE Class 1)

- Low profile LED beacon with extreme power and visibility.
- PC board with integrated micro controller; 9pcs of GEN 3 LEDs
- It meets SAE class 1, California title 13 and ECE Reg 65

P/N	COLOUR	VOLTAGE	AMPS	CTN
4650A	Amber	9V-16V	2.5A	6
4650B	Blue	9V-16V	2.5A	6
4650MA	Amber; Magnetic mount	9V-16V	2.5A	6

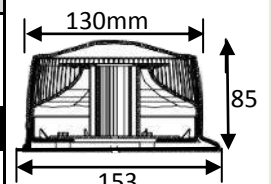

*Other colours are available

LED BEACONS + ROTATING BEACONS

4750A



SAE CLASS 1

RUBBER-BASED HIGH POWERED MEDIUM PROFILE LED BEACON (SAE Class 1)

- High-powered rubber-based LED beacon is popular with construction and disposal fleets. Quad flash.
- Polycarbonate lens is mounted on a rubber base for extra shock resistance
- Components are coated to protect from weather and road shock

P/N	COLOUR	VOLTAGE	AMPS	CTN
4750A	Amber LED	12V-24V	1.3A	20

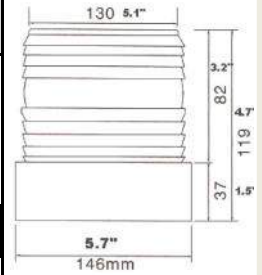

4941MPC



BATTERY POWERED LED BEACON

- Polycarbonate lens, Magnetic mount
- 360 degree LED beacon
- High intensity
- Single flash 75 FPM
- 100 hours of operation with "D" cell batteries x 2

P/N	COLOUR	VOLTAGE	AMPS	CTN
4941MPC	Amber LED	3V	1.3A	20

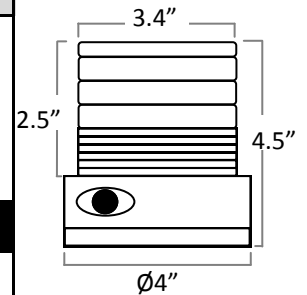

9524A



BATTERY OPERATED PORTABLE LED WARNING LIGHTS

- A great new safety and warning LED light that is battery operated and can be mounted anywhere
- Comes with magnetic mount and stand mount options
- No-maintenance LED lights, just replace the 4AA batteries [Good for up to 12 hours use]
- Two functions: flashing and constant on

P/N	COLOUR	VOLTAGE	CTN
9524A	Amber	4 AA batteries	24
9524B	Blue	4 AA batteries	24
9524R	Red	4 AA batteries	24

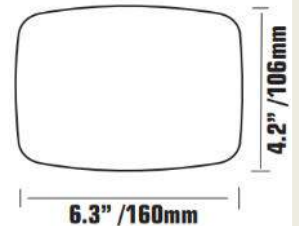

* Also Available in Blue LED (9524B) and Red LED (9524R)



1320MA



"Ko-Jack" Magnetic Mount Dual-Function Rotating Beacon

P/N	TYPE	Voltage	AMP	CTN
1320MA	Amber; Magnetic mount	12V	2 Amps	6
1320MB	Blue; Magnetic mount	12V	2 Amps	6

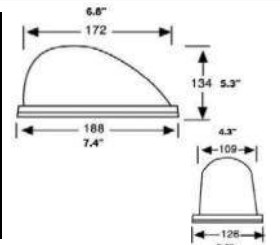

1371MA



Classic Magnetic Mount Rotator

P/N	TYPE	Voltage	AMP	CTN
1371MA	Amber; Magnetic mount	10V-12V	1 Amp	6
1371MB	Blue; Magnetic mount	10V-12V	1 Amp	6

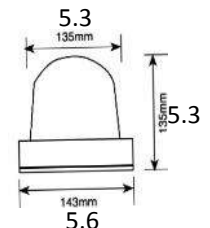

1371MB

DASH AND VISOR MOUNT WARNING SYSTEM

5.2" WINDOW MOUNT LED

- High-output LED; does not impair the driver.



SAE Class 1

- Easily attaches to the windshield with three suction cups and is designed for interior use only

- Every unit provides multiple flash patterns and includes an 8ft/2.44m coiled cord

6148A, 6148BR, 6148B, 6148R, 6148G

9.6" DASH-MOUNT AND PERMANENT MOUNT SUPER

SAE Class 1



- High-output LED; does not impair the driver's vision.
- Six flash patterns includes an 8ft /2.44m coiled cord

6149A, 6149B, 6149BR, 6149R

12.8" VISOR MOUNT 12 FUNCTION LED WARNING



SAE Class 1

- Compact design easily attaches to visor
- High-output LED producing incredible intensity without impairing the driver's vision

6150A, 6150B, 6150BR, 6150R

COMPACT WINDOW



SAE Class 1

- Powerful full window mount warning light with Gen III LED, produces great intensity without impairing driver's vision.

- 6151A, 6151B, 6151BR, 6151R

8000

Tear Away Safety Vests-5 Point

8001

- Heavy-duty construction meets ANSI/ISEA 107-2004 & CSA requirements

8002

- **8000** Orange vest / Yellow reflective striping

8003

- **8001** Orange vest / Yellow & Grey reflective striping

- **8002** Yellow vest / Orange reflective striping

- **8003** Yellow vest with Orange & Grey reflective striping



9044

Professional LED Magnetic Mount Work Light

- Heavy duty ABS construction, 60 LEDs shock resistant up to 4' drop.
- Works up to 8 hours on a full charge
- Water, oil and impact resistant
- Built in 9 LED flash light
- Comes with wall plug adapter car plug adapter
- Mounting magnet



9806

Viking Torch

COB Pull-Out Torch

- 6 LEDs at the top
- Unique pull-out function, 18 COB LED in the tube replaces fluorescent tube work light
- 3.6V 1800MAH rechargeable Ni-MH battery
- Magnetic base
- LED indicator for charging
- Comes with AC/DC adaptor and 12V car charger



9818

Foldable LED Service Light

- 7.4V 2000MAH Li-ION thin battery
- 120 pcs SMD LEDs
- Foldable
- Extendable body at both ends by 138mm to 186mm
- Comes with AC/DC adaptor and 12V car charger
- Viking tough ABS + Aluminum body



9807

LED Hand-held Work Light

- 3W high power COB LED 3.7V 1700MAH rechargeable Li-polymer battery
- Magnetic back for attaching to ferrous metal
- Over-charge protection function
- Accessories: AC/DC adaptor & 12V car plug charger



9820

LED Rechargeable Work Light

- 24 SMD LED work light
- 3.7V 1800MAH rechargeable Lithium-ION battery
- LED indicator for charging
- Comes with AC/DC adaptor charger. 2 power levels.
- Small but powerful
- Use at work garage, camping, sport events.



9181

3 in 1 Industrial Quality Accessory Panel

- Great to use with magnetic mount beacons, work lights, spot lights or anything with a car adapter plug
- With on/off switch, plug in up to 3 car adapter plugs into pane





LED Warning Star "Puck Light" Warning Flare and Beacon

Ideal replacement for traditional incendiary flares and plastic road reflectors, but are also the ideal safety option for all applications

Rechargeable Safety LED Flare and Emergency Light is an essential piece of equipment for police, firefighters, EMTs, rescue first responders and members of emergency response teams.

Environmentally friendly. The LED safety flare complies with federal Department of Transportation (DOT) safety standards, the Manual on Uniform Traffic Control Devices (MUTCD) traffic safety codes, the National Fire Protection Association (NFPA) traffic safety standards, and the State of California VOC emission guidelines for use as road safety flare in any traffic emergency.

Features

- Warning signal that is visible up to 1 mile
- The safety light has 10 incorporated patterns including SOS and solid-on.
- Magnetic mount Waterproof and floats on water. Making it ideal for marine use.
- Can function under harsh weather conditions. From 130 degree to minus 30 degree Fahrenheit.
- It can hold a charge for 8 to 100 hours depending upon the flash pattern.
- Rechargeable battery using: USB wall charger, car charger, and USB charging cable
- Colors: blue for marine & snow plows, orange/amber for warning beacon, red for road flares.
- Can be used as a road flare for traffic control.

LED WARNING LIGHT & ROAD FLARE		
P/N	COLOUR	CTN
9525KAA	Amber puck, Amber LEDs	20
9525KBB	Blue puck, Blue LEDs	20
9525KOA	Orange puck, Amber LEDs	20
9525KOR	Orange puck, Red LEDs	20
9525KYA	Yellow puck, yellow LEDs	20

9525KAA

9525KBB

9525KOA

9525KOR

9525KYA



9525K-6

9525KA-6

9525KBB-6

9525KYA-6



LED PUCK LIGHT CHARGING STATION KIT

LED charging station includes 6 LED puck lights that can be charged inside the case. Plug case into the wall or vehicle to start charging.

P/N	COLOUR	DESCRIPTION	CTN
9525K-6	Red puck, Red LEDs	6 Red Warning Star Pucks	6
9525KA-6	Amber puck, Amber LEDs	6 Amber Warning Star Pucks	6
9525KBB-6	Blue puck, Blue LEDs	6 Blue Warning Star Pucks	6
9525KYA-6	Yellow puck, Amber LEDs	6 Yellow Warning Star Pucks	6

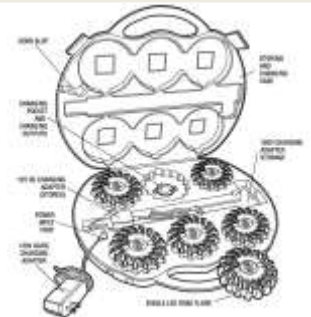

9526KOR

9526KYA

9526OR

9526YA



5 in 1 Safety Kit

This new safety kit is a great tool that has many uses

- LED ROAD FLARE
- LED FLASHLIGHT
- LED BATTON
- SEAT BELT CUTTER
- GLASS BREAKER

Includes USB cable, Car (12V) and Wall charger. Also has Magnetic Mount.

5 IN 1 SAFETY KIT				
P/N	COLOUR	TYPE	VOLTAGE	CTN
9526KOR	Red LEDs	5 in 1 safety Kit, Flash Light	Charges with AC, DC or USB adapters	10
9526KYA	Yellow LEDs	5 in 1 safety Kit, Flash Light	Charges with AC, DC or USB adapters	10
9526OR	Orange LEDs	Individual flares available		
9526YA	Amber LEDs	Individual flares available		

9526KOR-3

9526KYA-3



5 IN 1 SAFETY KIT CHARGING STATION

Charging station includes 3 LED 5 in 1 safety batons, wall and car adapter plug. Case charges all 3 units at one time. Replaces the old fashioned incendiary flares.

P/N	COLOUR	TYPE	VOLTAGE	CTN
9526KOR-3	Orange LEDs	5 in 1 safety Kit, Flash Light	Charges with AC, DC or USB adapters	1
9526KYA-3	Yellow LEDs	5 in 1 safety Kit, Flash Light	Charges with AC, DC or USB adapters	1

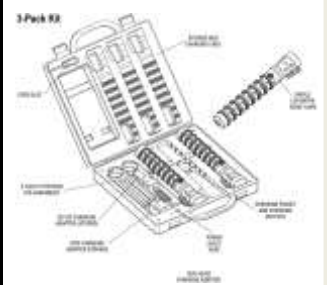



SUPER BRIGHT

SNEAK A STROBING LED

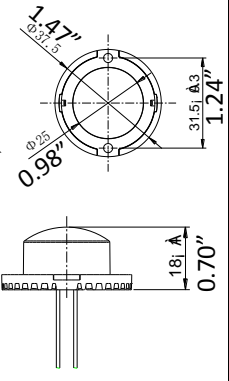

LED HIDE AWAY WARNING		
P/N	Colors	CTN
64120A	Amber LED	10
64120B	Blue LED	10
64120C	Clear LED	10
64120G	Green LED	10
64120R	Red LED	10

64120—Hide Away LED Warning Light

(Replaces Hide Away Strobes)

The New 64120 LED Hide Away light uses high powered SMD LEDs to produce 10 watts in a strobe like light source with 14 selectable flash patterns. The 64120 Sneak a Strobe LED will last over 45,000 hours and draws only 0.65 amps. The 64120 is compact and water proof, is conveniently mounted and easy to install. It is specially designed as a omni directional warning device for all types of emergency vehicles, tow vehicles and work vehicles. The 64120 can be mounted in a vehicle's head lamps, tail lamps a cornering lamp as a surface mount warning device using it's surface mount bracket.

Internal mount installation



SAE CLASS 1



64220AA

64220AC

64220BB

64220BC

64220CC

64220RC

64220RR

64220G



DUAL SNEAK A STROBE LED (LED Hide – Away) “Super Bright”

The 64220 is a Dual LED Hide A-way high power SMD LED light source that replaces a pair of hide-away strobes. Features a unique appearance, compact, with 30 flash patterns and the option of two different colours of LED's in each single lamp. The 64220 has superior circuit design (IP68 Rated), high brightness (18Watts each; 36W pair), low working current(1.2A), features easy installation (fits in 1" holes or can surface mount) and long service life (over 60,000 hours). Specially designed to be used on all types of emergency vehicles, police and security vehicles, tow trucks, work trucks, and where ever a warning device is needed. 5 year warranty.

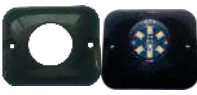

DUAL LED HIDE AWAY WARNING LIGHT (SAE CLASS 1)				
P/N	COLOR	Voltage	AMPS	LED
64220AA	Amber/Amber	DC10V-DC30V	1.2Amps	36W pair
64220AC	Amber/Clear	DC10V-DC30V	1.2Amps	36W pair
64220BB	Blue/Blue	DC10V-DC30V	1.2Amps	36W pair
64220BC	Blue/Clear	DC10V-DC30V	1.2Amps	36W pair
64220CC	Clear/Clear	DC10V-DC30V	1.2Amps	36W pair
64220G	Green	DC10V-DC30V	1.2Amps	36W pair
64220RC	Red/Clear	DC10V-DC30V	1.2Amps	36W pair
64220RR	Red/Red	DC10V-DC30V	1.2Amps	36W pair

* Bracket for 64220, 64240, and 64120 are the same

SAE CLASS 1

6103



SAE CLASS 1

SURFACE MOUNT WARNING LIGHT (SAE CLASS 1)

P/N	COLOUR	DESCRIPTION	VOLTAGE	AMPS	CTN
6103A	Amber	Warning Light	12V-24V	0.65	12
6103B	Blue	Warning Light	12V-24V	0.65	12
6103C	Clear	Warning Light	12V-24V	0.65	12
6103R	Red	Warning Light	12V-24V	0.65	12

6104



SAE CLASS 1

SURFACE MOUNT WARNING LIGHT (SAE CLASS 1)

P/N	Description	Colour	AMPS	CTN
6104A	Warning Light	Amber	0.9	12
6104AC	Warning Light	Amber & White, clear lens	0.9	12
6104B	Warning Light	Blue	0.9	12
6104BA	Warning Light	Blue & Amber	0.9	12
6104BC	Warning Light	Blue & White, clear lens	0.9	12
6104C	Warning Light	White, Clear lens	0.9	12
6104G	Warning Light	Green	0.9	12
6104R	Warning Light	Red	0.9	12
6104RB	Warning Light	Red & Blue	0.9	12
6104RC	Warning Light	Red & White, clear lens	0.9	12

NORTECH LED PERIMETER LIGHTING + LIGHT HEADS

- 6630A
- 6630B
- 6630C
- 6630G
- 6630R
- 6630BA
- 6630BB
- 6630BC
- 6630BG
- 6630BR
- 6630BRT
- 6630GRT



LED STROBING LIGHT HEAD



Grommet mount version



Surface mount version



- 14 User selectable flash patterns
- Sealed LED unit consists of 4 weather-proof 3 watt LEDs
- Surface mount or grommet mount versions available
- Meets SAE class 1 J845 and title 13

Nortech 6630 LED perimeter lights are compact lights with high performance LEDs. They meet SAE J845 class 1 specifications. Units can be synchronized with each others.

Lamp dimensions: 5.25" x 1.8"

5.25" LED STROBING LIGHT HEAD (SAE CLASS 1)			
P/N	DESCRIPTION	COLOUR	AMPS
6630A	Grommet mount warning Light	Amber	0.9
6630B	Grommet mount warning Light	Blue	0.9
6630C	Grommet mount warning Light	Clear	0.9
6630G	Grommet mount warning Light	Green	0.9
6630R	Grommet mount warning Light	Red	0.9
LED STROBING LIGHT HEAD WITH SURFACE MOUNT BRACKET			
6630BA	Warning Light with bracket	Amber LED	0.9
6630BB	Warning Light with bracket	Blue LED	0.9
6630BC	Warning Light with bracket	Clear LED	0.9
6630BG	Warning Light with bracket	Green LED	0.9
6630BR	Warning Light with bracket	Red LED	0.9
6630BRT	Bracket only for 6630 series		
6630GRT	Grommet only for 6630 series		

- 6663A-1
- 6663A-2
- 6663B-1
- 6663B-2
- 6663C-1
- 6663C-2
- 6663R-1
- 6663R-2



Blue + White



Amber



6" GROMMET MOUNT STROBING LED WARNING LIGHT					
P/N	DESCRIPTION	AMPS	VOLTAGE	COLOUR	
6663A-1	Warning Light	0.5	9-36V	Amber LED + lens	
6663A-2	Warning Light	0.5	9-36V	Amber LED + lens	
6663B-1	Warning Light	0.5	9-36V	Blue LED, clear lens	
6663B-2	Warning Light	0.5	9-36V	Blue LED, clear lens	
6663C-1	Warning Light	0.5	9-36V	White LED + lens	
6663C-2	Warning Light	0.5	9-36V	White LED + lens	
6663R-1	Warning Light	0.5	9-36V	Red LED + lens	
6663R-2	Warning Light	0.5	9-36V	Red LED + lens	

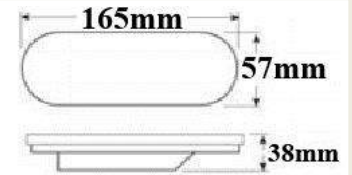

Dual or Quad system
4 Patterns | Synchronize pattern by connecting two of the same part numbers together | Alternating pattern by connecting two different part numbers ex. 6663A-1 + 6663A-2 | Single light works as strobe for warning | Random pattern can be achieved by disconnecting the black wire. System can be used as turn signal

- 6664A-1
- 6664A-2
- 6664B-1
- 6664B-2
- 6664C-1
- 6664C-2
- 6664R-1
- 6664R-2



4" GROMMET MOUNT STROBING LED WARNING LIGHT					
P/N	DESCRIPTION	AMPS	VOLTAGE	COLOUR	
6664A-1	Warning Light	0.5	9-36V	Amber LEDs + lens	
6664A-2	Warning Light	0.5	9-36V	Amber LEDs + lens	
6664B-1	Warning Light	0.5	9-36V	Blue LEDs, clear lens	
6664B-2	Warning Light	0.5	9-36V	Blue LEDs, clear lens	
6664C-1	Warning Light	0.5	9-36V	Clear LEDs + lens	
6664C-2	Warning Light	0.5	9-36V	Clear LEDs + lens	
6664R-1	Warning Light	0.5	9-36V	Red LEDs + lens	
6664R-2	Warning Light	0.5	9-36V	Red LEDs + lens	

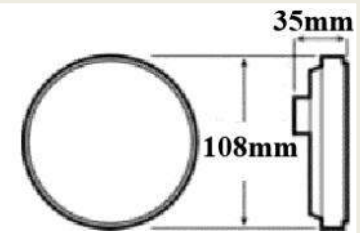

4 Patterns | Synchronize pattern by connecting two of the same part numbers together | Alternating pattern by connecting two different part numbers ex. 6664A-1 + 6664A-2 | Single light works as strobe for warning | Random pattern can be achieved by disconnecting the black wire. System can be used as turn signal

- 6666A

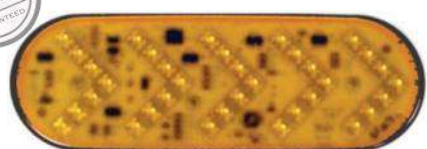

6" GROMMET MOUNT LED SEQUENTIAL ARROW		
P/N	DESCRIPTION	COLOUR
6666A	Warning arrow Light	Amber

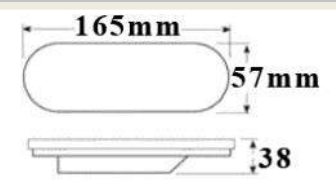

NORTECH EVOLUTIONE SERIES LED WORK LIGHTS



ALL EVOLUTIONE SERIES LIGHTS

- * Adjustable stainless Steel stud & Mounting Hardware
- * Polycarbonate lenses or glass lenses depending upon the light
- * Die-cast aluminum powder coated housing
- * New SMD LED chips + Integral heat sink, individual circuit to each chip.
- * Built with NO EMI radiation (No radio interference)
- * Shock Resistant & Water proof: IP 67 rated or higher, E13 and ROHS compliant
- * 3 Year customer satisfaction Warranty on EvolutionE series, most in VU pack





4.3" EVOLUTIONE SERIES LED WORK LIGHT

Designed as an industrial mining light, features trapezoid illumination beam which is wider than a spot and more focused than a flood beam. IP68/E13

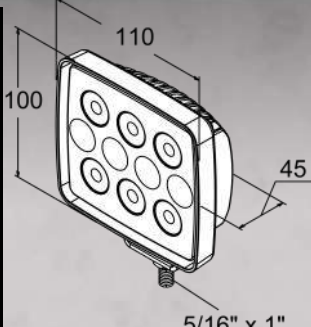
P/N	TYPE	VOLTAGE	AMPS	LUMENS	CTN
9052	Trapezoid beam	12V-28V	1.0A@12V 0.5A@28V	1400	12







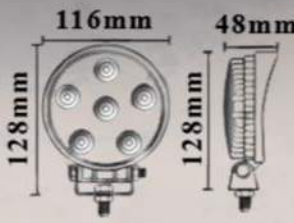

4.5" EVOLUTIONE SERIES LED WORK LIGHT

P/N	TYPE	VOLTAGE	AMPS	LUMENS	CTN
9056	Flood beam	10V-30V	1.3A@12V .65A@24V	18W output 1350 lm	20
9056S	Spot Beam	10V-30V	1.3A@12V .65A@24V	18W output 1350 lm	20
9056CH	Chrome	10V-30V	1.3A@12V .65A@24V	18W output 1350 lm	20







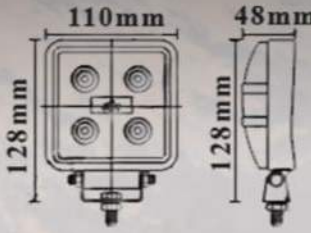

4.3" EVOLUTIONE SERIES LED WORK LIGHT

P/N	TYPE	VOLTAGE	AMPS	Lumens	CTN
9057	Flood beam	10V-30V	1.3A@12V .65A@24V	15W output 1200 lm	20
9057S	Spot beam	10V-30V	1.3A@12V .65A@24V	15W output 1200 lm	20
9057CH	Chrome	10V-30V	1.3A@12V .65A@24V	15W output 1200 lm	20







4.5" MAGNETIC MOUNT LED WORK LIGHT WITH CORD

Magnetic mount with 29.5ft cord with built in switch and car plug adapter. Cord allows for multiple outdoor uses

P/N	TYPE	VOLTAGE	AMPS	Lumens	CTN
9056MC	Magnetic Base & Cigarette Plug	12V-24V	1.3A@12V .65A@24V	18W output 1350 lm	10

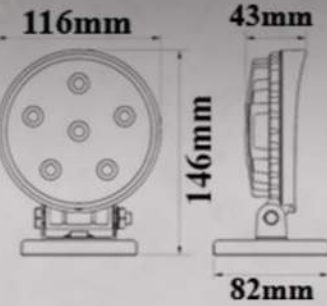

NORTECH EVOLUTIONE WORK LIGHTS

9058



4.3" EVOLUTIONE SERIES WORK LIGHT						
P/N	TYPE	VOLTAGE	AMP	LUMENS	CTN	
9058	Flood beam	10V-30V	2A@12V, .9A@24V.	27W output 2250 lm	20	
9058S	Spot beam	10V-30V	2A@12V, .9A@24V.	27W output 2250 lm	20	

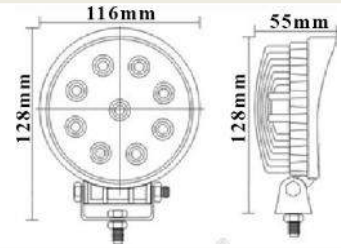

9059



4.3" EVOLUTIONE SERIES WORK LIGHT						
P/N	TYPE	VOLTAGE	AMP	LUMENS	CTN	
9059	Flood beam	10V-30V	2A@12V, .9A@24V	27W output 2250 lm	20	
9059S	Spot beam	10V-30V	2A@12V, .9A@24V	27W output 2250 lm	20	

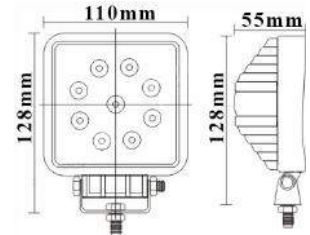

9060



5" EVOLUTIONE SERIES LED CONSTRUCTION LIGHT						
Heavy Duty Construction Work Light, Waterproof IP68, Great for construction purposes, replaces HID lights.						
P/N	TYPE	VOLTAGE	AMP	LUMENS	CTN	
9060	SMD LED Flood	9V-30V	2.6A@12V, 1.21A@24V	30W output 3000lm	12	

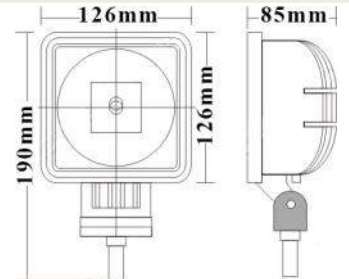

9062F



9062S

5.6" EVOLUTIONE SERIES LED TRUCK LIGHT						
P/N	TYPE	VOLTAGE	AMP	LUMENS	CTN	
9062F	Flood	12V-24V	2A@12V, 1A@24V	24W output 1800lm	10	
9062S	Spot	12V-24V	2A@12V, 1A@24V	24W output 1800lm	10	

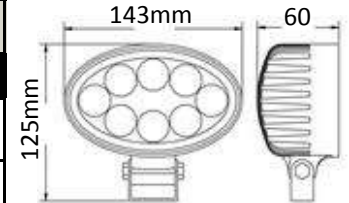

9064F



9064S

4" EVOLUTIONE SERIES LED CONSTRUCTION LIGHT						
Heavy Duty Construction Work Light, Waterproof IP68, Great for construction purposes. 30,000 hours life span. (109mm x 126mm x 71mm)						
P/N	TYPE	VOLTAGE	AMP	LUMENS	CTN	
9064F	Flood	9V-32V	2.6A@9V, 1.21A@32V	48W output 3071lm	10	
9064S	Spot	9V-32V	2.6A@9V, 1.21A@32V	48W output 3071lm	10	

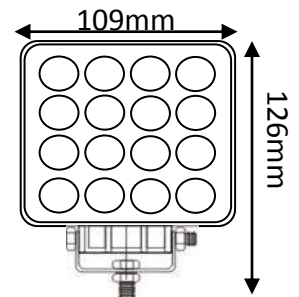

9065



INTERCONNECTABLE

2.6" CREE LED MINI MODULAR WORK LIGHT						
<ul style="list-style-type: none"> Allows the user to assemble multiple lights into various configurations. Water and shock resistance. Equipped with a high power 10W CREE LED. Can be used individually or combined with included mounting hardware. 						
P/N	TYPE	VOLTAGE	AMP	LUMENS	CTN	
9065	Evolutionary Interconnect-able Box Light	10V-30V	1A@12V, .5A@24V	1X10W Cree led, 1000lm	20	

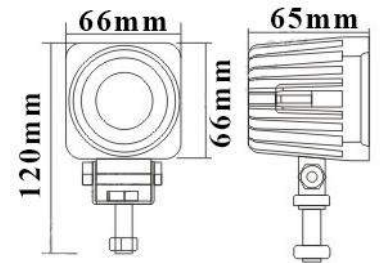



9066



4.3" EVOLUTIONE SERIES CREE LED WORK LIGHT						
<ul style="list-style-type: none"> Super Bright LED Work Light features 4x10W CREE SMD LED's. Great for industrial, agricultural and off-road use. 						
P/N	TYPE	Voltage	Amp	Lumens	CTN	
9066	Flood Lamp	10-30V	3A@12V, 1.5A@24V	40W output; 4000lm	20	
9066S	Spot Beam	10-30V	3A@12V, 1.5A@24V	40W output; 4000lm	20	

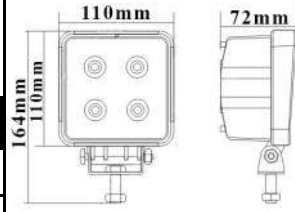

9066S



9067F



EVOLUTIONE SERIES WORK LIGHT						
P/N	TYPE	Voltage	Amp	Lumens	CTN	
9067F	Flood Beam	12V-48V	1.2A@12V, 0.6A@24V	42W output; 3080Lm	10	
9067S	Spot Beam	12V-48V	1.2A@12V, 0.6A@24V	42W output; 3080Lm	10	

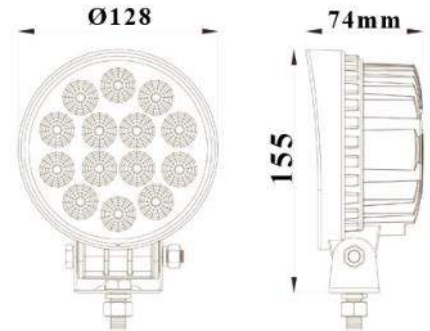

9067S



9068



3.7" LED AUXILIAR LIGHT (Pair)						
<ul style="list-style-type: none"> Universal 9 Watt Auxiliary Light Kit with mounting brackets. Cool White LEDs. low amp draw. Great to install in between the bumper grille, or below bumper. Kit includes 2-Lamps with attached mounting brackets. 						
P/N	TYPE	Voltage	Amp	Lumens	CTN	
9068	Auxiliary light	12V-24V	0.24A@12V, 0.125A@24V	9W output 480lm	20 pairs	

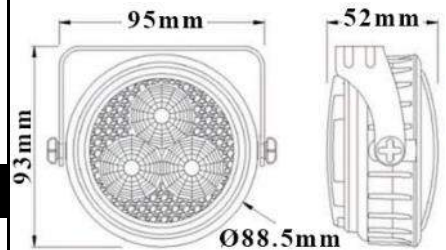

9069



6.3" EVOLUTIONE SERIES DRIVING & DRL LIGHT (pair)						
P/N	TYPE	VOLTAGE	AMP	LUMENS	CTN	
9069	Pair of LED die-cast running & driving light featuring Crystal Burst Optics	12V & 24V	0.48A@12V, 0.24A@24V	600lm	20 pairs	
9069ABS	Pair of LED ABS running & driving lights featuring Crystal Burst Optics	12V & 24V	0.15A@12V, 0.083A@24V	600lm	20 pairs	

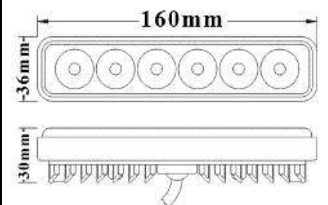

9069ABS



NORTECH VIKING POWER BARS COMBINATION SPOT FLOOD



POWER BAR

HIGH INTENSITY SINGLE ROW CREE LED VIKING POWER BARS

- Uses 10 Watt Cree LED | Waterproof rating:IP67 | Colour temperature: 6000K | Diecast Aluminum Housing | Lens material: PC | Mounting bracket: ALU firm bracket | Combo flood and spot beam patterns

P/N	TYPE	WATT	VOLTAGE	AMP	LUMENS	CTN
9071SF	14"; 6 LEDs x 10W	60W	10V—30V DC	4.26A@12V; 2.10A@24V	5400lm	6
9072SF	22"; 10 LEDs x 10W	100W	10V—30V DC	7.10A@12V; 3.50A@24V	9000lm	6
9073SF	30"; 14 LEDs x 10W	140W	10V—30V DC	9.94A@12V; 4.90A@24V	12600lm	4
9074SF	42"; 20 LEDs x 10W	200W	10V—30V DC	14.20A@12V; 7.0A@24V	18000lm	4
9075SF	51"; 24 LEDs x 10W	240W	10V—30V DC	17.40A@12V; 8.4A@24V	21600lm	4



9071SF

9072SF

9073SF

9074SF

9075SF



POWER BAR

SINGLE ROW CREE LED CURVED VIKING POWER BARS

- Uses 10 Watt Cree LED | Waterproof rating:IP67 | Colour temperature: 6000K | Diecast Aluminum Housing | Lens material: PC | Mounting bracket: ALU firm bracket | Combo flood and spot beam patterns

P/N	TYPE	WATT	VOLTAGE	AMP	LUMENS	CTN
9071CSF	14"; 6 LEDs x 10W	60W	10V—30V DC	4.26A@12V; 2.10A@24V	5400lm	6
9072CSF	22"; 10 LEDs x 10W	100W	10V—30V DC	7.10A@12V; 3.50A@24V	9000lm	6
9073CSF	30"; 14 LEDs x 10W	140W	10V—30V DC	9.94A@12V; 4.90A@24V	12600lm	4
9074CSF	42"; 20 LEDs x 10W	200W	10V—30V DC	14.20A@12V; 7.0A@24V	18000lm	4
9075CSF	51"; 24 LEDs x 10W	240W	10V—30V DC	17.40A@12V; 8.4A@24V	21600lm	4



9071CSF

9072CSF

9073CSF

9074CSF

9075CSF



POWER BAR

DOUBLE ROW CREE LED CURVED VIKING POWER BARS

- Uses 3 Watt Cree LED | Waterproof rating:IP67 | Colour temperature: 6000K | Diecast Aluminum Housing | Lens material: PC | Mounting bracket: ALU firm bracket | Combo flood and spot beam patterns | Features 3W CREE LED's

P/N	TYPE	WATT	VOLTAGE	AMP	LUMENS	CTN
9071DCSF	13.5"; 24 LEDs x 3W	72W	10V—30V DC	4.32A@12V; 2.16A@24V	5280lm	6
9072DCSF	21.5"; 40 LEDs x 3W	120W	10V—30V DC	7.20A@12V; 3.6A@24V	8800lm	6
9073DCSF	31.5"; 60 LEDs x 3W	180W	10V—30V DC	10.80A@12V; 5.4A@24V	13200lm	4
9074DCSF	41.5"; 80 LEDs x 3W	240W	10V—30V DC	14.40A@12V; 7.2A@24V	17600lm	4
9075DCSF	50"; 96 LEDs x 3W	288W	10V—30V DC	17.1A@12V; 8A@24V	21120lm	4
9075DCSF	53.5"; 104 LEDs x 3W	312W	10V—30V DC	19.4A@12V; 9.7A@24V	22880lm	4



9071DCSF

9072DCSF

9073DCSF

9074DCSF

9075DCSF

NORTECH EVOLUTIONE SERIES WORK DOUBLE STACK LIGHT BARS

9077F

9077S



CRYSTAL BURST OPTICS



5.9" EVOLUTIONE SERIES WORK LIGHT					
P/N	TYPE	VOLTAGE	AMP	LUMENS	CTN
9077F	Flood Beam	12V-24V	1.1A@12V 0.56A@24V	18W output 1350 lm	10
9077S	Long Range Spot Beam	12V-24V	1.07A@12V 0.55A@24V	18W output 1350lm	10

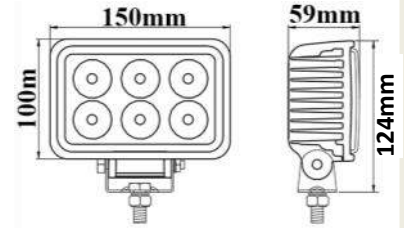

9081

9082

9083

9084

9085



EVOLUTIONE SERIES DOUBLE STACK LIGHT BARS					
P/N	TYPE	VOLTAGE	AMP	LUMENS	CTN
9081	4.6" LED Light Bar	12V-28V	1.07A@12V 0.53A@24V	18W output 1350lm	20
9082	7.9" LED Light Bar	12V-28V	1.57A@12V 0.89A@24V	36W output 2700 lm	10
9083	11.2" LED Light Bar	12V-28V	1.96A@12V 1.01A@24V	54W output 4050 lm	5
9084	14.5" LED Light Bar	12V-28V	2.15A@12V 1.10A@24V	72W output 5400 lm	5
9085	25.2" LED Light Bar	12V-28V	6.0A@12V 3.0A@24V	108W 8100 lm	5

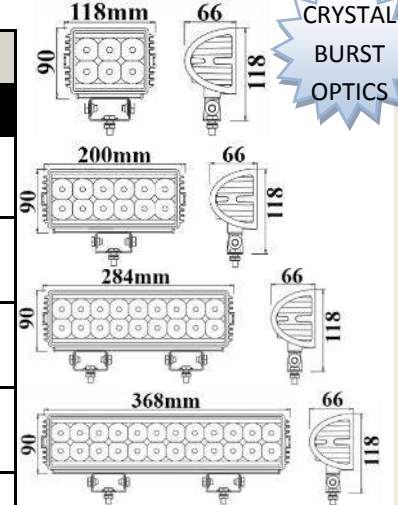

CRYSTAL BURST OPTICS

9089SB



SIDE BRACKET FOR EVOLUTIONE SERIES LIGHT BARS.

P/N	TYPE	ACCESSORIES	CTN
9089SB	Mounting Bracket	2 brackets + Mounting hardware	1 pair

Brackets fits 9081, 9082, 9083, 9084, 9091 9092, 9093

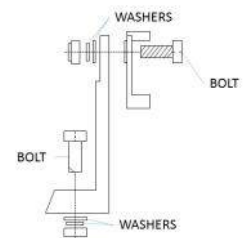

9091

9092

9093

9094



EVOLUTIONE SERIES SINGLE STACK LIGHT BARS					
P/N	TYPE	VOLTAGE	AMP	LUMENS	CTN
9091	7.9" LED Light Bar	12V-28V	1.07A@12V 0.51A@24V	18W output 1350 lm	20
9092	14.5" LED Light Bar	12V-28V	1.57A@12V 0.91A@24V	36W output 2700 lm	10
9093	21.1" LED Light Bar	12V-28V	1.96A@12V 1.10A@24V	54W output 4050 lm	5
9094	32.7" LED Light Bar	12V-28V	4.2A@12V 2.1A@24V	72W 5400 lm	5

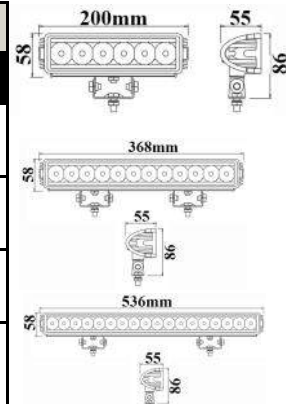

CRYSTAL BURST OPTICS



9081, 9082, 9083, 9084, 9091 9092, and 9093 light bars can be side mounted with our side bracket 9089SB
All Nortech EvolutionE series light bars are in VU boxes



9150



5.7" EVOLUTIONE SERIES HIGH POWERED CREE SMD LED WORKLIGHT

P/N	TYPE	VOLTAGE	AMP	LUMENS	CTN
9150	Flood Beam	10V-30V	4.2A@12V, 1.8A@24V	50W 5000lm	12

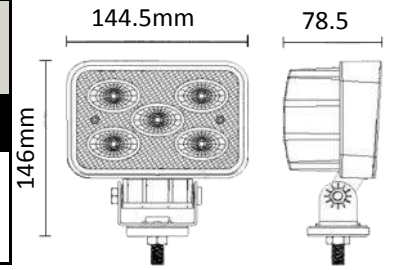

9200F



3.7"x 2" LED WORK LIGHT

P/N	TYPE	VOLTAGE	AMP	LUMENS	CTN
9200F	120 degree Flood	10V-30V	0.5A@10V 0.25@30V	726 Lm	40
9200S	120 degree Spot	10V-30V	0.5A@10V 0.25@30V	726 Lm	40

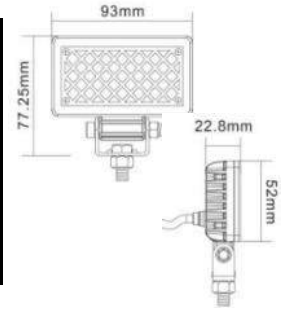

9200S

9202F



4.3"X 2.4" RECTANGULAR LED WORK LIGHT

- Tempered glass, cast aluminum shell.
- For industrial and agricultural use.

P/N	TYPE	WATT	VOLTAGE	AMP	LUMENS	CTN
9202F	Flood	20W	10V-30V	1.4A @ 12V, 0.75A@24V	900 Lm	20
9202S	Spot	20W	10V-30V	1.4A @ 12V, 0.75A@24V	900 Lm	20

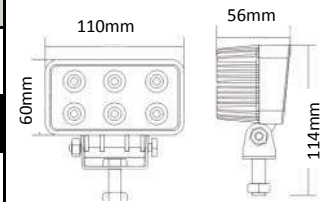

9202S

9203F



3" LED WORK LIGHT

P/N	TYPE	CCT	WATT	VOLTAGE	AMP	LUMENS	CTN
9203F	Flood Cree	6000K	10W	10V-30V	0.8A	800 Lm	20
9203S	Spot Cree	6000K	10W	10V-30V	0.8A	800 Lm	20

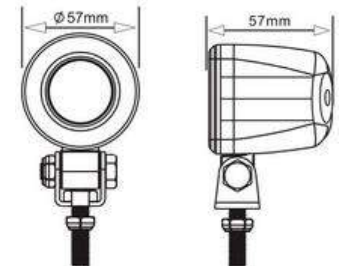

9203S

9204F



3" CUBE LED WORK LIGHT

P/N	TYPE	CCT	WATT	VOLTAGE	AMP	LUMENS	CTN
9204F	Flood Cree	6000K	10W	10V-30V	0.8A	800 Lm	20
9204S	Spot Cree	6000K	10W	10V-30V	0.8A	800 Lm	20

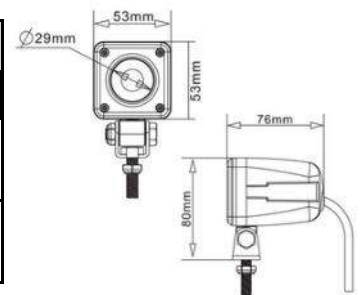

9204S

9205B



FORK LIFT SAFETY LIGHT

- Waterproof: IP67, Cree LED
- Die-cast Aluminum body

P/N	TYPE	VOLTAGE	AMP	LUMENS	CTN
9205B	Flood/Spot	9V-32V	1.27A	1800 Lm	20

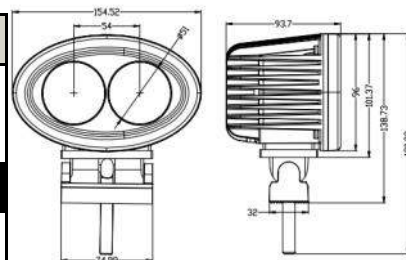

9212F



3.1" EVOLUTIONE SERIES CREE LED DRIVING & WORK LIGHT

P/N	TYPE	VOLTAGE	AMP	LUMENS	CTN
9212F	Flood Beam (90 degree)	10V-30V	1.34@12V, 0.67A@24V	16W output 1440 Lm	18
9212S	Spot Beam (8 degree)	10V-30V	1.34@12V, 0.67A@24V	16W output 1440 Lm	18
9212BF	Flood Beam (90 degree), With Bezel	10V-30V	1.34@12V, 0.67A@24V	16W output 1440 Lm	18
9212BS	Spot Beam (8 degree), With Bezel	10V-30V	1.34@12V, 0.67A@24V	16W output 1440 Lm	18

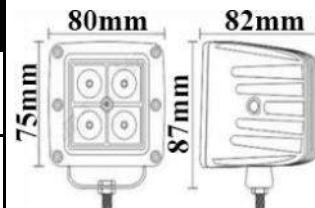

*Bezel Mount

*See price sheet for coloured covers

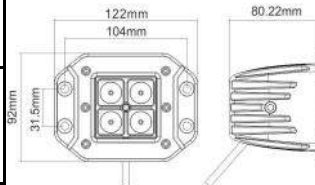

*Fits Jeeps

CRYSTAL BURST OPTICS

9212S

9212B

9212BS

9218F



3.15" EVOLUTIONE SERIES CREE LED DRIVING & WORK LIGHT

P/N	TYPE	VOLTAGE	AMP	LUMENS	CTN
9218F	Flood Beam (90 degree)	10V-30V	1.38A @12V, 0.675A@24V	18W output 2050 Lm	18
9218S	Spot Beam (25 degree)	10V-30V	1.38A @12V, 0.675A@24V	18W output 2050 Lm	18
9218BF	Flood Beam (90 degree), With Bezel	10V-30V	1.38A @12V, 0.675A@24V	18W output 2050 Lm	18
9218BS	Spot Beam (25 degree), With Bezel	10V-30V	1.38A @12V, 0.675A@24V	18W output 2050 Lm	18

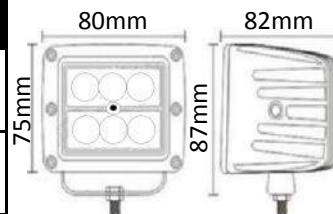

*Bezel Mount

*See price sheet for coloured covers

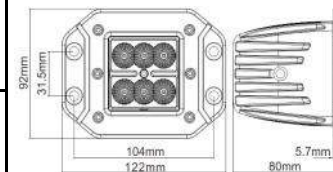

*Fits Jeeps

CRYSTAL BURST OPTICS

9218S

9218B

9218B

9236F



6.25 OVAL EVOLUTIONE SERIES HIGH POWERED LED WORK LIGHT

P/N	TYPE	WATT	VOLTAGE	AMP	LUMENS	CTN
9236F	Flood	36W	9V-32V DC	1.57A@12V	4597 Lm	10
9236S	Spot	36W	9V-32V DC	1.57A@12V	4597 Lm	10

9236S

NORTECH EVOLUTIONE SERIES WORK LIGHTS



9246F

9246S



7" - "SUPER DUTY" LED DRIVING LIGHT

Maintenance free 60 watt LED driving + work light. Die-cast aluminum corrosion resistant alloy housing bracket. With Crystal Burst Optics, waterproof, dustproof, can withstand very low and high temperatures. IP68 rated. Multiple applications: marine, small area lighting, off road, emergency vehicles, work trucks.

P/N	TYPE	VOLTAGE	AMP	LUMENS	CTN
9246F	Flood Beam	10V-30V	5.4@12V, 2.5A@24V	60W output 5000 Lm	8
9246S	Spot Beam	10V-30V	5.4@12V, 2.5A@24V	60W output 5000 Lm	8

SUPER HD

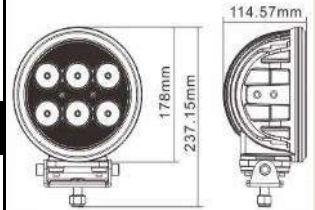

CRYSTAL BURST OPTICS

NEW



9260F

9260S



VU PACK

5.3" EVOLUTIONE SERIES CREE LED WORK LIGHT

- High Powered super heavy duty work light
- Waterproof: IP68 rated; min 35000 hours working life

P/N	TYPE	VOLTAGE	AMP	LUMENS	CTN
9260F	Flood Beam (90 degree)	10V-30V	5.4@12V, 2.5A@24V	60W output 6000 Lm	8
9260S	Spot Beam (10 degree)	10V-30V	5.4@12V, 2.5A@24V	60W output 6000 Lm	8

SUPER HD

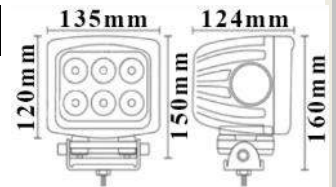

NEW

9269A

9269F

9269S



5.7" OVAL 18W WORK LIGHT

Oval work light also suitable for DRL, driving lights and fog lights. Waterproof IP68 rated

P/N	TYPE	VOLTAGE	AMP	LUMENS	CTN
9269F	Flood	12V-28V	1.05A@12V 0.55A@24V	18W 1350 Lm	20
9269S	Spot	12V-28V	1.05A@12V 0.55A@24V	18W 1350 Lm	20
9269A	Amber Fog lamp	12V-28V	1.05A@12V 0.55A@24V	18W 1350 Lm	20

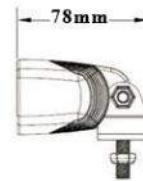
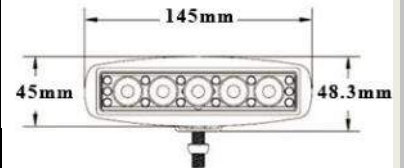

CRYSTAL BURST OPTICS



9269BF

9269BS



FLUSH MOUNT 6.3" OVAL WORK LIGHT WITH BAZEL

- Waterproof rate: IP 67
- .6pcs*3w high intensity OSRAMLED
- Housing:6.3"x2.8"x2.3"Cast Aluminum

P/N	TYPE	VOLTAGE	AMP	LUMENS	CTN
9269BF	Flood Beam pattern 90 degrees	10V-30V	1.4A@12V 0.7A@24V	1620 Lm	24
9269BS	Wide Spot Beam pattern 25 degrees	10V-30V	1.4A@12V 0.7A@24V	1620 Lm	24

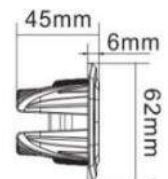
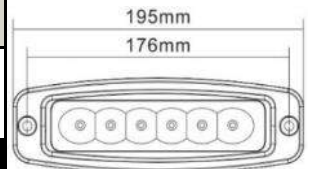

VU PACK

9290F

9290S



5.3" EVOLUTIONE SERIES CREE LED WORK LIGHT

- Heavy duty construction IP68/CE/RoHS

P/N	TYPE	VOLTAGE	AMP	LUMENS	CTN
9290F	Flood Beam pattern 90 degrees	10V-30V	5.8A@12V, 2.9A@24V	90W, 8100lm	8
9290S	Spot Beam pattern 10 degrees	10V-30V	5.8A@12V, 2.9A@24V	90W, 8100lm	8

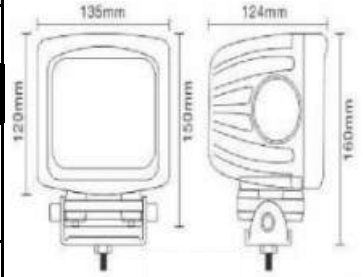

SUPER HD



9303

9304

9305

9316

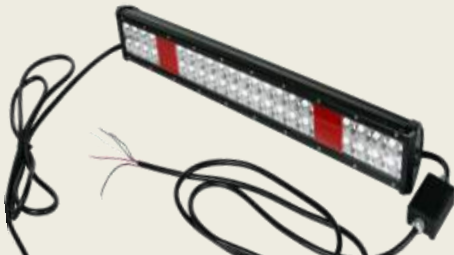

STOP

TAIL

TURN

LED BAR WITH AUXILIARY REAR LIGHTS



COMBINATION LED WORK LIGHT BAR WITH AUXILIARY STOP, TAIL, TURN LIGHTING FUNCTIONS

- Combination LED light bar with brake light, tail light, right and left turn signal
- Diecast aluminum housing, waterproof rate: IP 67, Color Temperature: 6000K
- Beam pattern: Spot/Flood
- Dimensions: 32 inch
- Functions: work light, brake light, tail light, right-left turn indicator

P/N	TYPE	WATTAGE	VOLTAGE	AMPS	LUMENS	CTN
9303	28" Bar with turn signal	120W	10V-30V	4.8A@12V	7200 Lm	4
9304	36" Bar with turn signal	180W	10V-30V	7.2A@12V	10000 Lm	4
9305	46" Bar with turn signal	240W	10V-30V	9.6A@12V	14400 Lm	4
9306	56" Bar with turn signal	300W	10V-30V	12.4A@12V	12600 Lm	4



POWER BAR

9380SF

9381SF

9382SF

9383SF

9384SF

9385SF



QUAD VIKING POWER BARS

- Uses 3 Watt Cree LED | Waterproof rating:IP67 | Colour temperature: 6500K | Diecast aluminum alloy housing | Lens material: PC | Mounting bracket: ALU firm bracket | Combo flood and spot beam patterns

P/N	TYPE	WATT	VOLTAGE	AMP	LUMENS	CTN
9380SF	3.9"; 12 LEDs	36W	9V-32V DC	2.13A@12V; 1.06A@24V	2520lm	12
9381SF	6.57"; 24 LEDs	72W	9V-32V DC	4.8A@12V; 2.4A@24V	5040lm	8
9382SF	9.25"; 26 LEDs	108W	9V-32V DC	7.2A@12V; 3.6A@24V	7560lm	8
9383SF	12"; 48 LEDs	144W	9V-32V DC	9.78A@12V; 4.89A@24V	10080lm	6
9384SF	14.57"; 60 LEDs	180W	9V-32V DC	12.4A@12V; 6.2A@24V	12600lm	6
9385SF	17.24"; 72 LEDs	216W	9V-32V DC	14.4A@12V; 7.2A@24V	15120lm	6

CRYSTAL BURST OPTICS



9345

7" DRIVING LIGHT

Size: 7" Driving Beam
 Combo Flood/Spot
 CREE, 15x3W = 45W
 10V-30V DC, 4050 Lm
 3.1A@12V; 1.6A@24V
 IP67, RoHS
 CTN: 8



9350

7" DRIVING LIGHT FOR OFF ROAD USE

Size: 7" Driving Beam
 Combo Flood/Spot 10°
 CREE, 16x5W = 50W
 10V-30V DC, 7200 Lm
 4.8A@12V; 2.4A@24V
 IP67, RoHS
 CTN: 4



9367

7" DRIVING LIGHT

Size: 7" Driving Beam
 CREE, 6x10W = 60W
 10V-30V DC; 5400 Lm
 3.6A@12V;
 1.8A@24V
 IP67, 6000K
 CTN: 8

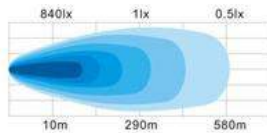

9369

9" DRIVING LIGHT

Size: 9" Driving Beam
 CREE, 6x10W
 10V-30V DC; 5400 Lm
 3.6A@12V;
 1.8A@24V
 IP67, 6000K, EMC
 CTN: 4

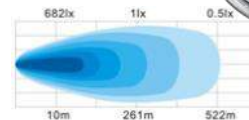

9343

45W HEAD LAMP

4"X 6" Head lamp
 Hi 2600 Lm/low 1800 Lm
 35000 hours of life
 10V-30V
 6000K; IP67
 Replaces H4656
 Diecast aluminum
 H4 3 blade connector



CREE

9343SB

45W LED HEAD LAMP with BRACKET

4"X 6" Head lamp with
 bracket
 Hi/low beam 1800 Lm
 10V-30V; 2600 Lm
 6000K; IP67
 35000 hours of life
 Diecast aluminum
 H4 3 blade connector



CREE

9344H

4" x 6" SQUARE LED HEADLIGHT

9344H—High beam only.
 9V-32V DC; 2200 Lm, 6pcs CREE LEDs
 Replaces H4651/6



9344L



9344L—Low beam only.
 9V-32V DC; 1200 Lm, 4pcs CREE LEDs
 Poly-carbonate lens and cover
 Replaces H4656

CREE

DOT COMPLIANT

9346

36W PAR 46 LED HEAD

36W, PAR16 Head lamp
 Hi/low beam
 30000 hours of life
 10V-30V; 3600 Lm
 6000K; IP67
 5.7" x 2.7" x 5.7"
 Diecast aluminum



CREE

9355

5" LED HEAD LAMP

5" head lamp
 Dual Hi/low beam
 9V-36V
 6000K; IP67
 50000 hours of life
 Diecast aluminum



DOT COMPLIANT

9356

7" PAR 56 LED HEAD LAMP

7" Par 56 head
 lamp
 Dual Hi/low beam
 10V-30V
 6000K; IP67
 50000 hours of life
 Diecast aluminum



DOT COMPLIANT

9357

LED HEAD LIGHT

5" x 7" Square LED head light
 Combo Hi 2600 Lm
 low 1800 Lm
 9V-32V
 4PC Cree LEDs
 Diecast aluminum



DOT COMPLIANT

MOUNTING ACCESSORIES AND INSTALLATION HARDWARE

AC-5102-2 | AC-5102-25

UNIVERSAL CLAMP BRACKET

Aluminum clam bracket.
Works with all LED lights. 2"
and 2.5" available.



AC-5100-125 | AC-5100-15 | AC-5100-2

UNIVERSAL CLAMP BRACKET

Aluminum bar clamp light mount, universal
fit, will work with all lights. 3 sizes including
1.25", 1.5" and 2" available.



AC-5015

UNIVERSAL PIPE MOUNT KIT

AC-5015-1 : 1"
AC-5015-125 : 1.25"
AC-5015-150 : 1.5"
AC-5015-175 : 1.75"
AC-5015-2 : 2"
AC-5015-225 : 2.25"
AC-5015-250 : 2.5"
AC-5015-275 : 2.75"
AC-5015-3 : 3"
AC-5015-325 : 3.25"
Attach LED light bars
to BullBar (Pipe)



AC-5009

X- MOUNTS CLAMPS

Allows mounting to tubes ranging
from 2" - 3" in diameter
Black powder coating finish
Includes all necessary hardware.



AC-5007

F150 BROW KIT

F150 Brow Mount Kit For Straight /Curve
led light bar, powder coat, includes all
necessary hardware.



AC-5001

WINDSHIELD MOUNT KIT

Jeep JK upper windshield light bar
mounts. Powder coat, includes all
necessary hardware.



SK-5003-10 | SK-5003-20

HOOD MOUNT KIT

Jeep light bar hood mount kit.
10" and 20". Black powder
coated, includes all necessary
hardware.



AC-5002

UNIVERSAL HOOD MOUNT KIT

Universal and Jeep Wrangler light
bar hood mount kit. Black
powder coated, includes all
necessary hardware.



AC-5004

DUAL LIGHT MOUNT KIT

Jeep pillar mount light kit for dual
lights. 2007-2015
Black powder coated, includes all
necessary hardware.



AC-5005

SINGLE LIGHT MOUNT KIT

Jeep JK A-Pillar mount for single
light kit. 2007-2015
Black powder coated, includes all
necessary hardware.



AC-5006

TAIL LIGHT MOUNT

Tail light mount kit Jeep JK Driver Side.
Tail Light Mount Jeep Wrangler 2007-
2015. Black powder coated, includes all
necessary hardware.



AC-5008

F150 FOG LIGHT KIT

Ford F150 light kit replacement
brackets.
Black powder coated, includes all
necessary hardware.



AC-5016

WINDSHIELD MOUNTING BRACKETS

Jeep windshield bracket kit can be used as a
universal bracket to mount lights as well. Fits
Jeep Wrangler 2007-2015. Black powder
coated, includes all necessary hardware.



HMWH

WIRE HARNESS

- 1 switch, 2 Terminals, 1DT plug. For LED light bars, 150W-9073KWH
- 1 switch, 2 Terminals, 2DT plug. For LED Work lights, 150W-9260KWH
- 1 switch, 2 Terminals, 1ATP plug. For LED light bars, 150W-9274KWH
- 1 switch, 2 Terminals, 2ATP plug. For LED Work lights, 150W-9290KWH
- 2 switch, 2 Terminals, 13PDT plug. For New Driving lights, 150W



NORTECH LED WORK LIGHTS

9048



RUBBER HOUSING 5" x 3" LED UTILITY LIGHT						
P/N	TYPE	Voltage	Amp	Lumens	CTN	
9048	Rubber	12V-28V	.5A@12V .26A @24V	450lm	20	
9048C	Chrome	12V-28V	.5A@12V .26A @24V	450lm	20	
9048W	White, Rubber	12V-28V	.5A@12V .26A @24V	450lm	20	
9048-01	Replacement sealed LED modules for 9048					

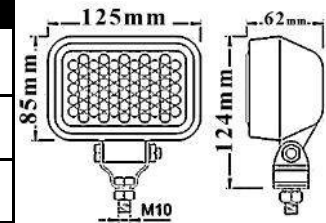

9048C

9048W



9050



RUBBER HOUSING PAR 36 LED TRACTOR/UTILITY LIGHT						
P/N	TYPE	Voltage	Amp	Lumens	CTN	
9050	Spot Beam	12V	.5A@12V	5.2W output 600lm	20	
9050-24V	Spot Beam	12V-24V	.5A@12V, .26@24V	5.2W output 600lm	20	
9050F	Flood Beam	12V	.5A@12V	5.2W output 600lm	20	
9050F-24V	Flood Beam	12V-24V	.5A@12V, .26@24V	5.2W output 600lm	20	
9050-01	Replacement sealed LED modules for 9050 includes LED sealed unit and wire					
9050F-01	Replacement sealed LED modules for 9050F, includes LED sealed unit and wire					
9050HD	Spot Beam	9V-32V	0.95Amps	1800 lumens	20	
9050FHD	Flood Beam	9V-32V	0.95Amps	1800 lumens	20	
9050-01HD	Replacement sealed LED modules for 9050HD, any par 36 housing; 1800lm					
9050F-01HD	Replacement sealed LED modules for 9050FHD, any par 36 housing; 1800lm					

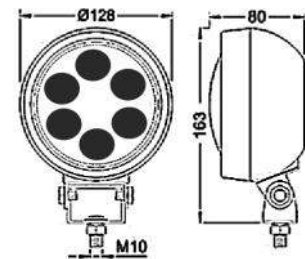
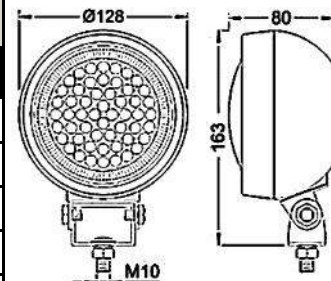

9050F

9050HD

9050FHD



9050A



RUBBER HOUSING PAR 36 LED WARNING LIGHTS						
P/N	TYPE	Voltage	Amp	Lumens	CTN	
9050A	Amber	12V	.5A@12V	5.2W output, 600lm	20	
9050B	Blue	12V	.5A@12V	5.2W output, 600lm	20	
9050G	Green	12V	.5A@12V	5.2W output, 600lm	20	
9050R	Red	12V	.5A@12V	5.2W output, 600lm	20	

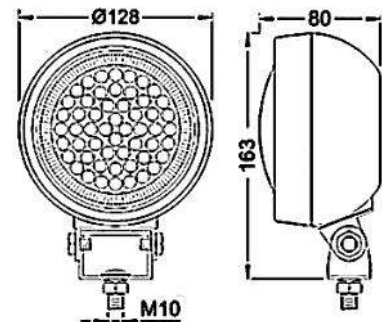

9050B

9050G

9050R

9050W



WHITE RUBBER HOUSING PAR 36 LED WORK LIGHT						
Par 36 White Rubber LED Work Light, great for the marine industry, truck bodies, and tow trucks						
P/N	TYPE	Voltage	Amp	Lumens	CTN	
9050W	Work Light, Spot Pattern par 36	12V-28V	.5A@12V, .26A@24V	324lm	20	

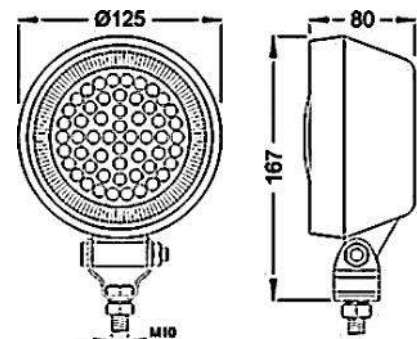

9051



4.9" LED CHROME WORK LIGHT						
P/N	TYPE	Voltage	Amp	Lumens	CTN	
9051	ABS Chrome Work Light	12V	.5A@12V	600lm	20	
9056CH	Chrome Work Light	10V-30V	1.3Amps	1350lm	20	
9057CH	Chrome Work Light	10V-30V	1.3Amps	1200lm	20	

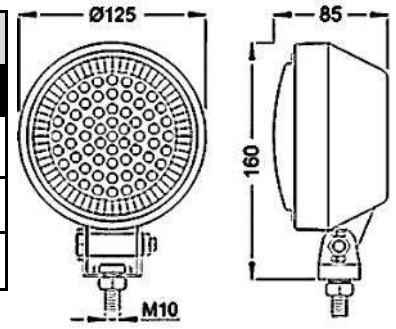

9053F



RUBBER HOUSING PAR 36 SMD LED WORK LIGHT

- Par 36 LED work light features the latest SMD LED chip technology that produce a true white light source that will last over 50,000 hours.
- Multi-Volt, 550 lumen fully sealed waterproof & shock resistant LED unit. Features a rubber housing, polycarbonate lens and stainless steel mounting hardware.

P/N	TYPE	Voltage	Amp	Lumens	CTN
9053F	Work Lamp	12V-24V	.8A@12V, .4V@24V	6W output 550lm	20

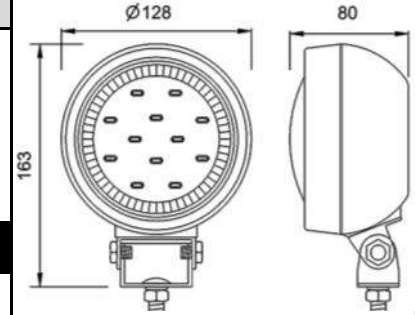

NEW SMD
CHIP

9061



6" - "BAJHA" LED WORK LIGHT WITH HANDLE & SWIVEL MOUNT

6 inch Round High Powered LED light. 12 x 1 Watt high power Cool White LEDs. 12-24VDC operating voltage range, IP67 waterproof light. Black coated aluminum housing with integral heat sink, and polycarbonate lens. Produces narrow spot 20 degree beam pattern. Permanent mount LED spotlight is equipped with a control handle and tension hinges that allow the unit to be easily adjusted and set into position. Includes mounting hardware.

P/N	TYPE	Voltage	Amp	Lumens	CTN
9061	BAJHA HI LITE with Handle	12V & 24V	2.6A@12V, 1.21A@24V	12W output 1350lm	8
9061SB	Square base with Handle and Mounting screws	12V & 24V	2.6A@12V, 1.21A@24V	12W output 1350lm	8
9061WS	Handle, mounting base, and Water-proof Switch	12V & 24V	2.6A@12V, 1.21A@24V	12W output 1350lm	8

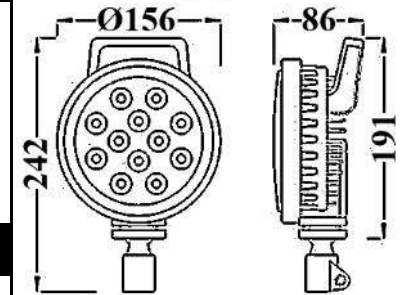

9061SB

9061

9061WS



9061SB



9061WS

WATERPROOF
SWITCH

9063



6" - "BAJHA" LED WORK LIGHT

6 inch round high powered LED light great for off road use. IP67 rated water proof + shock proof.

P/N	TYPE	Voltage	Amp	Lumens	CTN
9063	BAJHA HI LITE , Spot Beam	12V & 24V	.9A@12V, .5A@24V	12W output 1350lm	10

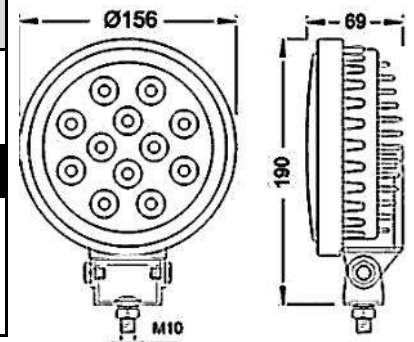

LED HEAD LAMP CONVERSION KITS AND FUSES

9704K
9705K
9706K
9707K
9711K
9713K
9714K
9717K
9721K
9723K
9752K
9780K



MEETS OEM SPECS

LED HEAD LAMP CONVERSION KITS

- Conversion kit includes 2 LED head lights and driver (includes canbus)
- Over 35,000 hours of life span; waterproof and dust proof
- Excellent heat dissipation, replaces HID head lamp kits
- Easy installation (Plug-in play), meets DOT specification.

P/N	OEM#	VOLTAGE	OUTPUT POWER	LUMENS	CCT	BEAM
9704K	9004 (HB1)	10V-32V	22W/30W	2000L/2600H	6000K	Hi/Low
9705K	9005 (HB3)	10V-32V	24W	2200H	6000K	Single Hi
9706K	9006 (HB4)	10V-32V	24W	2200L	6000K	Single Low
9707K	9007 (HB5)	10V-32V	22W/30W	2000L/2600H	6000K	Hi/Low
9711K	8911 (H8, H9, H11)	10V-32V	24W	2200	6000K	Single
9713K	9008 (H13)	10V-32V	22W/30W	2000L/2600H	6000K	Hi/Low
9703K	9003 (H4)	10V-32V	22W/30W	2000L/2600H	6000K	Hi/Low
9717K	H7 (HB2)	10V-32V	24W	2200	6000K	Single
9721K	H1	10V-32V	24W	2200	6000K	Single
9723K	H3	10V-32V	24W	2200	6000K	Single
9752K	5202 (H16)	10V-32V	24W	2200	6000K	Single
9780K	880/881	10V-32V	24W	2200	6000K	Single

FUSE ASSORTMENT KITS

SUPER MINI FUSE KIT

100 pc kit

PN: FKSM01



MINI FUSE KIT

100 pc kit

PN: FKM02



MAXI FUSE KIT

100 pc kit

PN: FKMA03



TYPE ATO/ATC FUSE KIT

100 pc kit

PN: FKAT01



INDIVIDUAL BOXED FUSE PROGRAM



SUPER MINI FUSES

PN	Amps	Colour
FSM5	5	Tan
FSM7	7.5	Brown
FSM10	10	Red
FSM15	15	Blue
FSM20	20	Yellow
FSM25	25	Clear
FSM30	30	Green



MINI AUTOMOTIVE FUSES

PN	Amps	Colour
FM5	5	Tan
FM7	7.5	Brown
FM10	10	Red
FM15	15	Blue
FM20	20	Yellow
FM25	25	Clear
FM30	30	Green



MAXI AUTOMOTIVE FUSES

PN	Volts	Amps	Colour
FMX20	32	20	Yellow
FMX30	32	30	Green
FMX40	32	40	Orange
FMX50	32	50	Red
FMX60	32	60	Blue
FMX70	32	70	Tan
FMX80	32	80	Clear



TYPE ATO/ATC FUSES

PN	Amps	Colour
FATO5	5	Tan
FATO7	7.5	Brown
FATO10	10	Red
FATO15	15	Blue
FATO20	20	Yellow
FATO25	25	Clear
FATO30	30	Green
FATO40	40	Amber

9133



BACK-UP ALARM WITH GROUND PLATE

- Modern design, single sound level
- ABS housing with encapsulated components
- Available in 87, 97, 102 decibels
- Meets CE, E11 and SAE J994 requirements

P/N	TEMPERATURE	VOLTAGE	DECIBELS
9133-97	-40°C (104°F) to 85°C (185°F)	12V-48V	97 dcb
9133-87	-40°C (104°F) to 85°C (185°F)	12V-48V	87 dcb

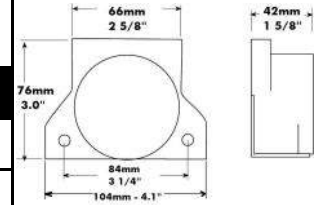

9138



BACK-UP ALARM

- Designed for mounting in tight areas
- Single sound level with #8-32 UNC term
- ABS housing, bracket covers a wide range of mounting applications
- Operating range 12-24 volt
- Meets CE, IP67 and SAE requirements

P/N	TEMPERATURE	VOLTAGE	DECIBELS
9138-97	-40°C (104°F) to 85°C (185°F)	12V-24V	97 dcb

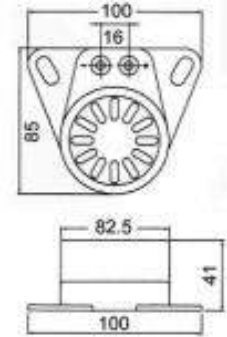

9165



BACK-UP ALARM

- Used for all vehicle and forklift applications
- Terminal stud-mounted unit
- ABS housing with encapsulated components
- Steam cleanable, pressure washable
- Less than .5 amp draw, single sound level
- Meets CE, E11, IP67 & SAE J994 requirements

P/N	TEMPERATURE	VOLTAGE	DECIBELS
9165-87	-40°C (104°F) to 85°C (185°F)	12V-48V	87 dcb
9165-97	-40°C (104°F) to 85°C (185°F)	12V-48V	97 dcb
9165-102	-40°C (104°F) to 85°C (185°F)	12V-48V	102 dcb

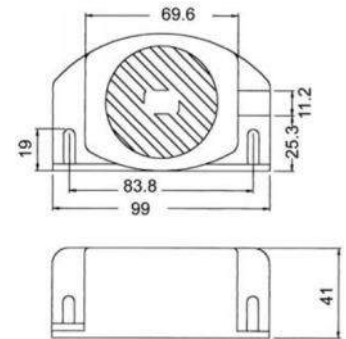

9169



EASY MOUNT SELF GROUNDING BACK-UP ALARM

- For heavy duty truck and all rubber tired vehicle application
- Unit can be grounded through mounting screw
- Glass-filled nylon housing with encapsulated components
- Steam cleanable, pressure washable
- Less than .65 amp draw, single sound level
- Meets CE, E11, IP67 and SAE requirements

P/N	TEMPERATURE	VOLTAGE	DECIBELS
9169-87	-40°C (104°F) to 85°C (185°F)	12V-48V	87 dcb, SAE type D
9169-97	-40°C (104°F) to 85°C (185°F)	12V-48V	97 dcb, SAE type C
9169-102	-40°C (104°F) to 85°C (185°F)	12V-48V	102 dcb, SAE type F
9170-97	-40°C (104°F) to 85°C (185°F)	12V-80V	97 dcb, SAE type C
9170-102	-40°C (104°F) to 85°C (185°F)	12V-80V	107 dcb, SAE type B

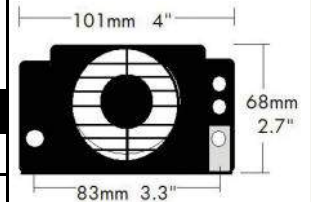

9170

NORTECH BACKUP ALARMS

9190



ROUND GROMMET FITTING BACK-UP ALARM

- Grommet mount back-up alarm fits into industry standard 4.5" grommet for 4" tail lights
- Hard wired for weather tight seal, SAE type C.
- Meets CE, E11, Ip67 and SAE J994 requirements

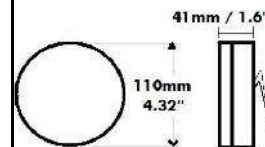

P/N	TEMPERATURE	VOLTAGE	DECIBELS
9190	-40°C (104°F) to 85°C (185°F)	12V-48V	97 dcb



9199



ECONOMICAL BACK-UP ALARM

- back-up alarm in a VU-PACK
- Dual terminal, components sealed
- Single sound level

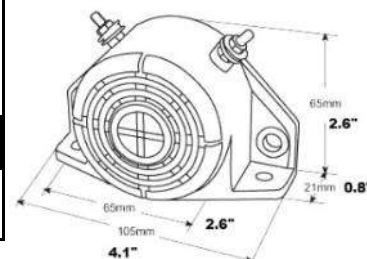

P/N	TEMPERATURE	VOLTAGE	DECIBELS
9199	-40°C (104°F) to 85°C (185°F)	12V-36V	97 dcb



9499

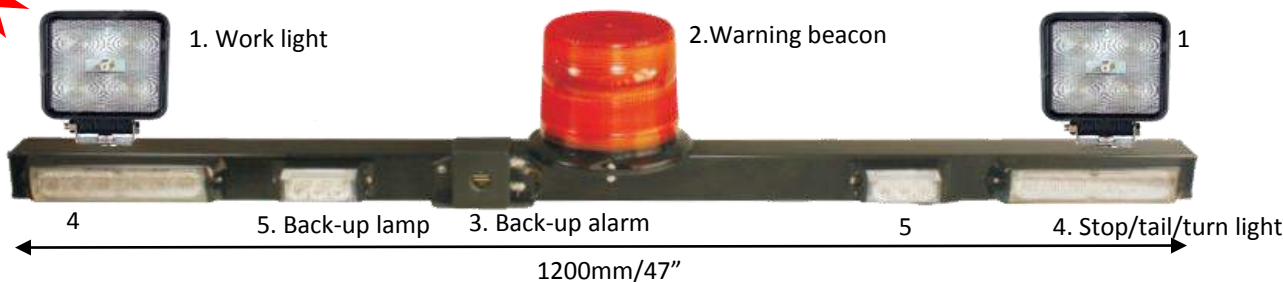

COMBINATION LED LIGHT BAR AND WARNING SYSTEM

- Low profile Combination Bar features directional signal, tail lights, stop lights, backup light, back-up alarm, warning light and work lights, prewired and on a bar ready to install.
- Weather proof design great for pick-up trucks, SUV, mining vehicles, and work trucks

P/N	TYPE	OPERATING TEMPERATURE	DUAL VOLTAGE	CTN
9499	All in one Light bar	-40°C (104°F) TO +65°C (149°F)	12Vdc	1

- 9499 Contains:
- 1) 2 x LED diecast work light; 1300lm each
 - 2) 1 x LED beacon class 2
 - 3) 1 x 97 decibel back-up alarm
 - 4) 2 x LED stop/tail/turn lights
 - 5) 2 x LED back-up lamps

Nortech Innovative Products offers a complete line of back-up alarms with various sound levels and operating voltages to meet your back-up alarm requirements. Our back-up and safety alarm coverage is one of the broadest in the industry. Our standard back-up alarms come with a 2-year warranty. With our program there is no need to carry alarms of different operating voltages. All of our alarms are multi-voltage to reduce the number of SKU's you need to stock. Reliable and durable - our large coverage of alarms will satisfy your needs.

REAR-VIEW SAFE-T-CAM SYSTEM

CAMERA SYSTEMS

9100



SAFETY CAM- 7" WIDESCREEN, COLOR CAMERA SYSTEM

- Safety Cam system is automatically activated when reverse gear is engaged
- Designed for heavy duty vehicle applications; work trucks, vans, buses, motor homes.
- Includes multilingual 7" color LCD video display
- Video inputs (AV1, AV2, AV3)
- 120 degree night vision CCD weather-proof camera with 18 infrared LEDs that provide 35' nighttime visibility.
- Includes 65ft/20m waterproof harness
- This kit has everything you need to get started: monitor, camera, 65ft harness and cable. Two cameras can be added
- Shock rating 150G; Vibration rating 15G
- IP68, E13, FCC, CE

P/N	TYPE	CORD LENGTH	VOLTAGE	CTN
9100	Safety Cam	65ft	DC10-30V	1

9100TC



SAFETY CAM- 7" CAMERA, DESIGNED FOR TRAILER APPLICATIONS

- Automatically activated when reverse gear is engaged
- Night vision camera (18 pcs infrared LED), high resolution picture quality even in low illuminated conditions with nighttime visibility up to 35'
- Full function wireless control
- 7" safety camera, colour LCD, multilingual, video inputs (AV1, AV2, AV3)
- Specially designed for trailers
- Shock rating 100G; Vibration rating 15G
- IP68, E13, FCC, CE
- Can be connected with two cameras

P/N	TYPE	VOLTAGE	CTN
9100TC	Safety Cam	DC10-30V	1

9100W



7" HEAVY DUTY DIGITAL WIRELESS REAR VIEW CAMERA

- Designed for trucks, work trucks, trailer, bus, RV or 5th wheel
- 7" colour LCD wireless display
- Night vision CCD camera with 18 infrared LEDs with night time visibility up to 35' with a 130 degree angle
- Transmission power 10mw/50mw
- System is automatically adjusted when the reverse gear is engaged
- IP68, E13, FCC, CE

P/N	TYPE	CORD LENGTH	VOLTAGE	CTN
9100W	Wireless rear view camera system	Wireless	12V-24V	1

9102



4.3" "MIRROR CAMERA" CAMERA

- Rear-view mirror with built-in monitor
- Suitable for pickup trucks, SUV and car.
- Automatically activated when the reverse gear is engaged
- Wide vision camera
- Night vision and water proof IP68

P/N	TYPE	VOLTAGE	CTN
9102	Reverse camera	DC12V	1
9102W	Digital wireless version	DC12V	1

*Available in wireless



9105

5" REAR VIEW CAMERA SYSTEM

- Automatically activated when the reverse gear is engaged
- Multilingual, 5" digital panel, supports 2 channel video inputs
- Shock resistant, designed specifically for mobile use

P/N	TYPE	VOLTAGE	CTN
9105	Reverse camera	DC12V-24V	1



9120

5.6" REAR VIEW CAMERA SYSTEM WITH MOUNTING DISH

- Heavy duty rear view camera system
- Automatically activated when the reverse gear is engaged
- Night vision (18 IR LEDs), high resolution picture quality even in low illuminated conditions up to 35' of night time visibility
- Full function wireless control
- Multilanguage, video inputs (AV1, AV2, AV3)
- Especially designed for bus and heavy duty vehicle applications
- IP68, E13, FCC, CE

P/N	TYPE	VOLTAGE	CTN
9120	Rear view camera system	12V-24V	1
9120-2	5.6" monitor	12V-24V	1



9124

DVR WITH HDD AND SD

- Supports two SD cards and one 2.5" SATA HDD with lock
- 4-channel DVR recording, 4 cameras input
- Over voltage, over current and short current protection.
- U.S. military grade shock and vibration standard.
- External 2A@12V for camera
- Advance H.264 technology offers highly compressed file size capability for maximum recording time support.
- Video file are protected and saved periodically before abnormal power off .
- Remote monitoring.
- Optional WiFi, 3G, and GPS

P/N	TYPE	VOLTAGE	CTN
9124DVR	DVR HDD/SD recorder	10V-30V	1



9125

7" QUAD REAR-VIEW MONITORING SYSTEM

- For heavy duty trucks, bus, work truck applications
- 7" Quad systems includes:
- 7" Quad TFT digital LCD monitor with 4 way inputs, automatic switching with picture in picture function. Single, Dual and Quad images available on monitor.
- 4 CCD water-proof night vision 120 degree cameras with visibility up to 35' at night time.
- Video is changed automatically to rear view when backing up
- Electronic shutter 1/100,000 on/off

P/N	TYPE	VOLTAGE	CTN
9125	Monitoring System	DC10-30V	1



CAMERA SYSTEMS

9109QV

9109RV



SAFETY CAM- 9" QUAD AND REAR VIEW CAMERA SYSTEM

- Safety Cam system is automatically activated when reverse gear is engaged
- Specially designed for bus and heavy duty vehicle applications
- Includes 9" color LCD video display
- Comes with 1 day/night vision CCD camera with 18 IR LEDs
- Includes 65ft/20m waterproof harness
- This kit has everything you need to get started: monitor, camera, harness and cable
- Waterproof IP68, E13, FCC, CE

P/N	TYPE	DISPLAY	VOLTAGE	CTN
9009QV	9" Quad view monitor	TFT 9" monitor with 4 -way AV input	10VDC -32VDC	1
9109RV	9" Rear view camera system	TFT 9" monitor with 3 video frequency input	10VDC -32VDC	1

MONITORS

9100-1 | 7" Monitor

- LCD video display
- Multi-language
- 12-24V
- 3 video inputs (AV1, AV2, AV3), automatic/manual switcher



9102-1 | 4.3" Rear-view camera

- 4.3" digital TFT LCD
- DC12V
- Brightness: 300 cd/m²
- Reflection mirror optional



9125-TS | 7" Quad monitor with touch panel

- Almighty Operating system
- Touch screen
- DC12V-24V
- Single, Dual, Triple and Quad available
- Auto switches to working channel



9100-2MC | Mini CCD camera

- DC8V-15V
- 500 x 582 px
- 120 degrees
- Waterproof IP67, vibrations-resistant



ACCESSORIES

9100-2 | Day and night CCD camera

- Waterproof
- DC12V
- 1.5W
- Color CCD
- View angle: 120 degrees



9100-2W | Day and night Wireless CCD camera

- Waterproof
- DC12V
- 1.5W
- Color CCD
- View angle: 130 degrees



9100-2AS | Day and night CCD camera with OSD

- Integrated on screen menu system
- Waterproof
- DC12V
- Color CCD
- View angle: 120 degrees



9125-2TS | 360 degree rotation CCD camera

- DC12V
- Vibration-resistant
- View angle: 120 degrees
- Waterproof IP67



9100-4 | Waterproof harness

- 65 feet
- Connects display and camera



9105-2 | Day and night CMOS camera

- Metal body
- Waterproof IP67
- DC12V



9125-2LV | Large vehicle reversing CCD camera

- DC12V
- Day and night
- 120 degrees
- Color



9120-2TC | Transit Camera

- DC12V
- Up to 170 degrees
- Waterproof IP67



ACCESSORIES

GREAT OEM SPEC "EXACT FIT" PROGRAM

9103RD

BRAKE LIGHT CAMERA FOR MERCEDES SPRINTER

9103MS

Break Light
IP68
Image sensor:
Resolution: 420
(700TVL)
Lens Angle: 120
degrees
Replaces mounts in OEM third brake light



RAM PROMASTER BRAKE LIGHT BACKUP CAMERA

4.3" rearview mirror monitor
5" high brightness digital LCD monitor
CMOS, 420TVL
1/4 Sharp CCD
Replaces mounts in OEM third brake light

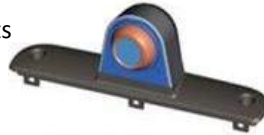

9104SM

BALL CAMERA WITH SHARK MOUNT

Ball Camera with shark mount
IP68
Image sensor: 1/4" CCD
Resolution: 480
Lens Angle: 120 degrees
No audio



MIRROR CAM

9104MC

No blind spots
Flexible installation on mirror arm
Clamp bracket adjustable for front view/side view
No need to drill holes
IP68, 120°, 1/4 Sharp CCD



GSV001L

GSV001R

VOLVO HEAD-LAMP OEM

VOLVO VNL head-lamp
original
Black
OEM
Left: 82329124
Right: 8239127
Nortech
Left: GSV001L
Right: GSV001R



GSV002L

GSV002R

VOLVO HEAD-LAMP-ALL CHROME

VOLVO VNL head-lamp
Chrome/White
OEM
Left: 82329124
Right: 82329127
Nortech
Left: GSV002L
Right: GSV002R



NORTECH EXACT FIT PROGRAM

FREIGHTLINER

COLUMBIA HEAD-LAMP PROJECTOR STYLE

GSFR005L

Columbia head-lamp
1996-Present

GSFR005R

OEM
Left: A06-51041-000
Right: A06-51041-001

Nortech
Left: GSFR005L
Right: GSFR005R



GSFR004L

GSFR004R

COLUMBIA HEAD-LAMP OEM REPLACEMENT

OEM
Left: A06-32496-006
Right: A06-32496-007

Nortech
Left: GSFR004L
Right: GSFR004R



*For chrome add C

Chrome Bezel for Columbia
120 head-lamp
1996—Present



GSFR014

GSFR008L

GSFR008R

FREIGHTLINER M2 HEAD-LAMP

- OEM replacement: A06-51039-000/001
- Truck model: Freightliner Columbia M2 100/106/112
- Year: 2002-Present
- Headlight Assembly include lens, socket, housing, bulbs.

OEM
Left: A06-50139-000
Right: A06-50139-001

Nortech
Left: GSFR008L
Right: GSFR008R



FREIGHTLINER

CENTURY LAMPS AND BEZEL

GSFR012-2

Century 2005
Truck head lamp
OEM: A06-36847-000

GSFR124B

Century 2005 head lamp bezel
available in Chrome and Black
Black OEM: A06-43865-000
Chrome OEM: A06-43865-0002

GSFR124C

Century 2005 side lamp
OEM: A06-21643-000

GSFR012-3



9046JDF

9046JDS

JOHN DEERE

JOHN DEERE 18W REPLACEMENT

Voltage: 9-32V
Wattage: 18W
Rated to: IP67
Beam pattern:
9046JDF—Flood
9046JDS—Spot
Lumens: 1800 Lm

Spot OEM: RE19080
Flood OEM: RE88946



9043JD

JOHN DEERE

12W RECTANGLE LED WORK LIGHT

Voltage: 9-32V
Wattage: 12W
Lumens: 800 Lm
Type: 4 Cree Leds
OEM: 127085



9050HD-1

9050FHD-1

Par36 replacement sealed beam.

Spot OEM: 70230232
Flood OEM: 70239804



Also available Freightliner Cascadia, International Mack, Kenworth head lamps.

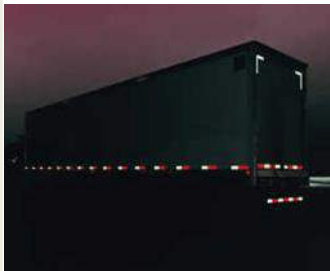

We sell custom conspicuity tape



FARM TRACTOR

Transportation Grade Conspicuity Tape:

- For ultimate night time visibility, use our microprismatic high-intensity tape
- Meets or exceeds all requirements.
- Provided with the DOT-C2 markings as per NHTSA 9CFR571.108
- Outdoor rated and easy to use, 7 year rated
- 2" (51mm) x 150' reflective tape with alternating red and silver (legal white) patterns.

CONSPICUITY TAPE DOT— C2—NHTSA 9CFR571.108	
P/N	SPECIFICATIONS
9106-5	2"x 6" (red) x 6" (silver) x 150ft roll / 152mm (red) x 152mm (silver) x 51mm x 45.72m roll
9106-51	1" x 6" (silver) x 6" (red) x 150ft roll
9107-5	Same as 9106-5 conspicuity tape kiss cut every 12 inches (perforated)
9108-5	2" White (silver) Conspicuity Tape, 150ft roll
9111-5	2" x 7" (silver) x 11" (red) x 150ft roll
9111-51	1" x 7" (silver) x 11" (red) x 150ft roll
9112-5	2" x Same as 9111-5 conspicuity tape kiss cut every 18in (perforated)

PACKAGED STRIPS	
P/N	SPECIFICATIONS
9106K	Conspicuity Tape Kit, 8 pieces of 2" x 6" x 6" strips, DOT-C2. Bagged and carded
9111K	Conspicuity Tape Kit, 8 pieces of 2" x 7"/11" strips, DOT-C2. Bagged and carded

DOT-C2 CUSTOM CONSPICUITY TAPE WITH NAME/LOGO	
[Each roll is 2" (5.1cm x 150ft (45.72m) with your company's name or logo] Provided with the DOT-C2 markings as per NHTSA 9CFR571.108	
P/N	SPECIFICATIONS
9106CNL	Same as 9106-5 but with your company's name and or logo on the tape. Minimum order applies.
9111CNL	Same as 9111-5 but with your company's name and or logo on the tape. Minimum order applies.

AGRICULTURAL VEHICLE WARNING TAPE RETRO-REFLECTIVE CONSPICUITY TAPE		
Used for warning agricultural vehicles. Red for the rear warning width and yellow visible to the front. Other colours available on request.		
P/N	SPECIFICATIONS	DESCRIPTION
95200R	2" x 150' Red	Agricultural marking tape
95200Y	2" x 150' yellow	Agricultural marking tape



REFLECTIVE TAPE FOR RAILWAY CARS	
P/N	SPECIFICATIONS
9127-4	Yellow Retro-reflective conspicuity tape for marking rail cars; 4" x 150ft roll. ASTM D4956-01a



SCHOOL BUS REFLECTIVE TAPE	
P/N	SPECIFICATIONS
9128 -1	Yellow Retro-reflective conspicuity tape for marking School buses. 1" x 150ft microprismatic school bus tape
9128-2	Yellow Retro-reflective conspicuity tape for making School buses. 2" x 150ft microprismatic school bus tape
9128S	Yellow school bus sign



- Our EvolutionE reflectors will not fall off like plastic reflectors with an adhesive backing. The EvolutionE reflector sticks to anything and is easy to install, no screws. The reflector meets SAE A, DOT specifications and ASTM IV.
- The EvolutionE reflectors are available in 2 shapes: round and rectangular.

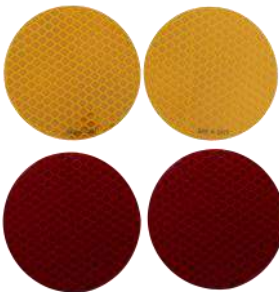

9490



9491

EVOLUTIONE REFLECTORS			
P/N	COLOR	SPECIFICATIONS	CTN
9490A	Amber	Round 2 7/8" SAE A, DOT, ASTM reflector	100
9490R	Red	Round 2 7/8" SAE A, DOT, ASTM reflector	100
9490KA	Amber	2 pcs of 9490A poly bagged and carded	25
9490KR	Red	2 pcs of 9490R poly bagged and carded	25
9490A-10	Amber	10 pcs of 9490A poly bagged and carded	100
9490R-10	Red	10 pcs of 9490R poly bagged and carded	100
P/N	COLOR	SPECIFICATIONS	CTN
9491A	Amber	Rectangle reflector 4 5/16" x 1 11/16"	100
9491R	Red	Rectangle reflector 4 5/16" x 1 11/16"	100
9491KA	Amber	2 pcs of 9491A poly bagged and carded	25
9491KR	Red	2 pcs of 9491R poly bagged and carded	25
9491A-10	Amber	10 pcs of 9491A poly bagged and carded	100
9491R-10	Red	10 pcs of 9491R poly bagged and carded	100

LED<SMD<SMD LED



**BEEP
BEEP**



LED MINI BULBS SMD CHIP

P/N	DESCRIPTION	COLOUR	VOLTAGE	CTN
194ASMD	T10wedge-11 (SMD Chip)	Amber	12V	2
194ASMDL	T10wedge-09 (SMD with LED)	Amber	12V	2
194BSMDL	T10wedge-11 (SMD Chip)	Blue	12V	2
194GSMDL	T10wedge-09 (SMD with LED)	Green	12V	2
194RSMD	T10wedge-11 (SMD Chip)	Red	12V	2
194RSMDL	T10wedge-09 (SMD with LED)	Red	12V	2
194SMD	T10wedge-11 (SMD Chip)	White	12V	2
194SMDL	T10wedge-09 (SMD with LED)	White	12V	2
194BSMDL	T10wedge-09 (SMD with LED)	Blue	12V	2

P/N	DESCRIPTION	COLOUR	VOLTAGE	CTN
1004SMD	SMD Bulb	Chrome	12V	1

P/N	DESCRIPTION	COLOUR	VOLTAGE	CTN
1156RSMD	T25-10-19LEDS	Red	12V	1
1156ASMD	T25-10-19LEDS 1156 BA15S (SMD Chip)	Red	12V	1
1156SMD	T25-10-19LEDS 1156 BA15S (SMD Chip)	White	12V	1
1157ASMD	T25-10-19LEDS 1157 BAY15D (SMD Chip)	Amber	12V	1
1157RSMD	T25-10-19LEDS 1157 BAY15D (SMD Chip)	Red	12V	1
1157SMD	T25-10-19LEDS 1157 BAY15D (SMD Chip)	White	12V	1

P/N	DESCRIPTION	COLOUR	VOLTAGE	CTN
3156SMD	Single control (SMD Chip)	White	12V	2
3156ASMD	Single (SMD Chip)	Amber	12V	2
3157SMD	Double control (SMD Chip)	White	12V	2
3157RSMD	Double centre red (SMD Chip)	Red	12V	2

LED MINI BULBS

P/N	DESCRIPTION	COLOUR	VOLTAGE	CTN
1895AHP	Ba9s-07HP	Amber	12V	2
1895RHP	Ba9s-07HP	Red	12V	2
1895WHP	Ba9s-07HP	White	12V	2

BACK-UP ALARM AND LED BACK-UP LIGHT

P/N	DESCRIPTION	COLOUR	VOLTAGE	CTN
9140	Replaces vehicles back-up light bulb (1156/7) with a led light and back-up alarm. Activates when the vehicle backs up.	Amber	12V	2



P/N	DESCRIPTION	COLOUR	VOLTAGE	CTN
3157LED	3157-02 -36LEDS	White	12V	1
3157ALED	3157-02 -36 LEDS	Amber	12V	1
3157RLED	3157-02 -36 LEDS	Red	12V	1



P/N	DESCRIPTION	COLOUR	VOLTAGE	CTN
194APC	T10 Wedge-05	Amber	12V	2
194PC	T10 Wedge-05	White	12V	2
194RPC	T10 Wedge-05	Red	12V	2



P/N	DESCRIPTION	COLOUR	VOLTAGE	CTN
904	Led Bulb 2 pack	White	12V	2

P/N	DESCRIPTION	COLOUR	VOLTAGE	CTN
921	Led Bulb 2 pack	White	12V	2

LED MINI BULBS (ECONOMY)



P/N	DESCRIPTION	COLOUR	VOLTAGE	CTN
1156	T25-01-19LEDS 1156 BA15S	White	12V	1
1156A	T25-01-19LEDS 1156 BA15S	Amber	12V	1
1156R	T25-01-19LEDS 1156 BA15S	Red	12V	1
1157	T25-01-19LEDS 1157 BAY15D	White	12V	1
1157A	T25-01-19LEDS 1157 BAY15D	Amber	12V	1
1157R	T25-01-19LEDS 1157 BAY15D	Red	12V	1



P/N	DESCRIPTION	COLOUR	VOLTAGE	CTN
1895A	Ba9s-11	Amber	12V	2
1895R	Ba9s-11	Red	12V	2
1895W	Ba9s-11	White	12V	2



P/N	DESCRIPTION	COLOUR	VOLTAGE	CTN
3157	3157-01 19 LEDS	White	12V	1
3157A	3157-01 19 LEDS	Amber	12V	1
3157R	3157-01 19 LEDS	Red	12V	1



M1212

Pc

12V



CATS EYE SERIES

1212 "Cats Eye" series 3/4" round clearance/marker light. The Cats Eye features 3 SMD LED chips. The light is waterproof (IP68) and compacted draws 20mA. Fits into a 3/4" hole. Kit comes with light and grommet.

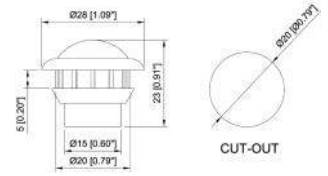

M1212K SERIES NO OUTLET CONNECTORS			
P/N	DESCRIPTION	CTN	PKG
M1212KA	Amber lens/ amber led	125	10
M1212KC	Clear lens/ white led	125	10
M1212KCA	Clear lens/ amber led	125	10
M1212KCB	Clear lens/ blue led	125	10
M1212KCG	Clear lens/ green led	125	10
M1212KCR	Clear lens/ red led	125	10
M1212KR	Red lens/ red led	125	10
M1212SS	Stainless steel bezel	100	1

M1212KB SERIES WITH BULLET CONNECTORS			
P/N	DESCRIPTION	CTN	PKG
M1212KBA	Amber lens/ amber led	125	10
M1212KBC	Clear lens/ white led	125	10
M1212KBCA	Clear lens/ amber led	125	10
M1212KBCB	Clear lens/ blue led	125	10
M1212KBCR	Clear lens/ red led	125	10
M1212KBR	Red lens/ red led	125	10
M1212SS	Stainless steel bezel	100	1

Meets **FMVSS 108**

M1260

P2

Pc

12V



CATS EYE DOT SERIES (OVAL) (FITS 3/4" hole)

"CATS EYE" Dot SERIES OVAL

1260 Cats Eye Dot series features engineered lens optics and functions as clearance, side marker or identification light. It draws 40mA and fits in a 3/4" hole, 2 connectors with bullet terminals. Waterproof rating: IP68

P/N	DESCRIPTION	CTN	PKG
M1260KBA	Amber lens/ amber led with bullet terminal	200	10
M1260KBC	Clear lens/ white led with bullet terminal	200	10
M1260KBR	Red lens/ red led with bullet terminal	200	10
M1260KBCA	Clear lens/ amber led with bullet terminal	200	10
M1260KBCR	Clear lens/ red led with bullet terminal	200	10
M1260SS	Stainless steel bezel for M1260 series	100	1

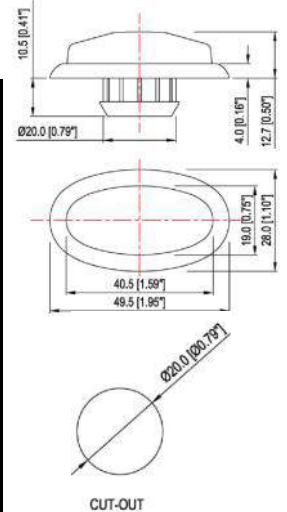

Meets **FMVSS 108**

M1268

P2

Pc

12V



CATS EYE SERIES

1.5" ROUND LED CLEARANCE/MARKER LAMP

'Cats Eye' 1.5" Round LED clearance/marker lamp. Engineered optics, compact design mounting in 1 3/8" hole. Features 4 SMD LEDs, 2 wire design, draws 40mA, waterproof meets FMVSS108/SAE requirements.

P/N	DESCRIPTION	CTN	PKG
M1268KBA	Amber lens/ amber led (with bullet terminal)	50	10
M1268KBC	Clear lens/ white led (with bullet terminal)	50	10
M1268KBR	Red lens/ red led (with bullet terminal)	50	10

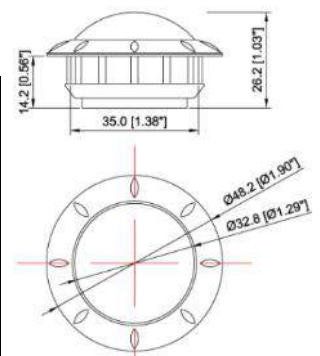



Meets **FMVSS 108**

S2402RTR  **6" OVAL LED SEALED STOP, TURN WITH CATS EYE TAIL LIGHT FUNCTION**

P/N	DESCRIPTION	AMPS	CTN
S2402RTR	Red stop/tail/turn light only	0.42 amps	50
S2402CRTR	Red stop/tail/turn light only, clear lens	0.42 amps	50

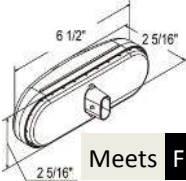
SAE(3) 13.5V DOT COMPLIANT Meets FMVSS 108 S/T/T



S2412ATR  **LED 6" OVAL SEALED TURN SIGNAL WITH CATS EYE TAIL LIGHT FUNCTION**

P/N	DESCRIPTION	AMPS	CTN
S2412ATR	Amber turn signal light	0.42 amps	50
S2412CATR	amber turn signal light only, clear lens	0.42 amps	50

SAE(3) 13.5V DOT COMPLIANT Meets FMVSS 108

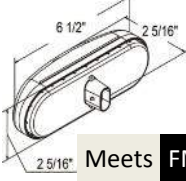

S2480CTR  **LED 4" ROUND SEALED STOP, TURN, TAIL LIGHT WITH CATS EYE GLOW**

P/N	DESCRIPTION	AMPS	CTN
S2480CTR	Polycarbonate lens, polycarbonate base, SMD LED 7pcs. Inner circle with round convex design on lens, round guide light strip design in the outer circle, sonically sealed for waterproof, use waterproof plug assembly to keep corrosives away from the LED lamps, for over 80" application.	0.33 amps	50

SAE 13.5V DOT COMPLIANT Meets FMVSS 108

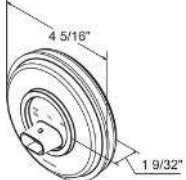

B3906CTR  **LED BACK UP LIGHT WITH CATS EYE TAIL LIGHT FUNCTION**

P/N	DESCRIPTION	AMPS	CTN
B3906CTR	Oblong clear turn signal 6"	0.33 amps	50
B3980CTR	white back-up/ red tail light 4"	0.33 amps	50

SAE 13.5V DOT COMPLIANT Meets FMVSS 108

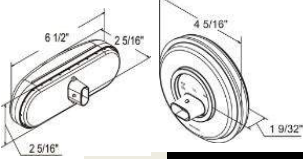



CATS EYE DUAL BEAM LED CLEARANCE MARKER + ID LIGHTS

M1661A  **CATS EYE DUAL BEAM 5.7" RECTANGULAR LED MARKER CLEARANCE**

P/N	DESCRIPTION	AMPS	CTN
M1661A	Amber	0.05 amps	50
M1661C	Clear	0.05 amps	50
M1661R	Red	0.05 amps	50

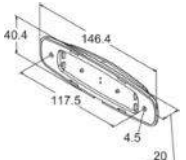
SAE 12V DOT COMPLIANT Meets FMVSS 108



M1671A  **CATS EYE DUAL BEAM 4.6" RECTANGULAR LED MARKER CLEARANCE**

P/N	DESCRIPTION	AMPS	CTN
M1671A	Amber	0.05 amps	50
M1671C	Clear	0.05 amps	50
M1671R	Red	0.05 amps	50

SAE 12V DOT COMPLIANT Meets FMVSS 108

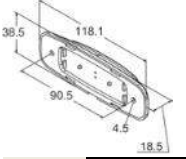

M1681A  **CATS EYE DUAL BEAM 3.5" RECTANGULAR LED MARKER CLEARANCE**

P/N	DESCRIPTION	AMPS	CTN
M1681A	Amber	0.05 amps	50
M1681C	Clear	0.05 amps	50
M1681R	Red	0.05 amps	50

SAE 12V DOT COMPLIANT Meets FMVSS 108

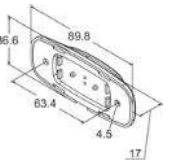

CLEARANCE AND MARKER LAMPS

M1211

- P2
- F4
- 12V
- PC



3/4" SEALED LED MARKER and CLEARANCE LIGHT

Two diodes. Waterproof design. Hard wired with grommet

P/N	DESCRIPTION	AMPS	CTN
M1211KA	Kit with grommet; Amber lens and led	50mA	50
M1211KC	Kit with grommet; Clear lens and led	50mA	50
M1211KCA	Kit with grommet; Amber led, clear lens	50mA	50
M1211KCR	Kit with grommet; Red led, clear lens	50mA	50
M1211KR	Kit with grommet; Red lens and led	50mA	50

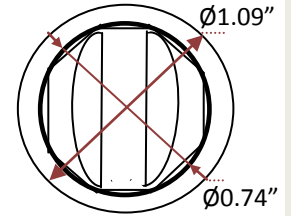

Meets FMVSS 108

M1255

- P2
- 12V

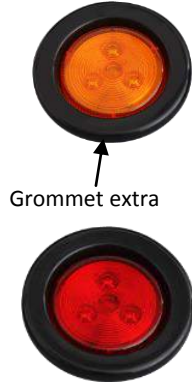

Grommet extra

2" "TRI LED" CLEARANCE AND MARKER LAMPS

1255 series sealed 2" round sealed 3 SMD LED Clearance/Marker Polycarbonate lens, 3 SMD LED's, waterproof seal, draws 60 mA, life of 100,000 hours meets DOT FMVSS 108.SAE requirements

P/N	SIZE	AMPS	CTN
M1255A	Amber 2", 3 LEDs	60mA	50
M1255R	Red 2", 3 LEDs	60mA	50
M1255GB	Grommet flush mount	N/A	100
M1255P	2 wire plug double seal	N/A	50
M1256GBC	Closed back 2" grommet	N/A	50

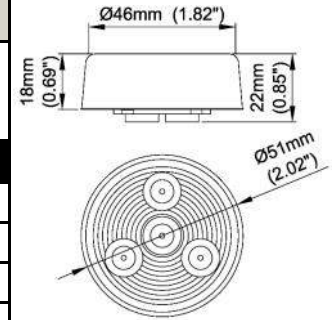

Meets FMVSS 108

M1256

- P2
- 12V



2 wire pigtail

2" "UNE LED" CLEARANCE AND MARKER LAMPS

1256 series 2" round sealed LED clearance/marker light. Uses 1 SMD LED for long life. Meets FMVSS 108/SAE requirements.

P/N	DESCRIPTION	AMPS	CTN
M1256A	Amber 2", 1 LEDs	60mA	50
M1256R	Red 2", 1 LEDs	60mA	50
M1255GB	2" Grommet flush mount	N/A	100
M1255P	2 wire plug double seal	N/A	50
M1256GBC	2" closed back grommet for 2" light	N/A	50

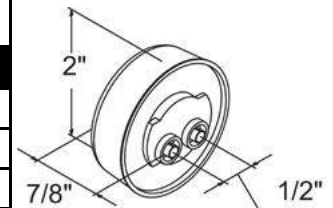

Meets FMVSS 108

M1257

- P2
- Pc
- 12V



Grommet extra

2.5" "TRI LED" CLEARANCE AND MARKER LAMPS

1257 series 2.5" round sealed LED clearance/marker light. Sonically sealed waterproof design, 100,000 hours of life. Accepts right angle plug. Meets FMVSS 108/SAE requirements.

P/N	DESCRIPTION	AMPS	CTN
M1257A	Amber 2.5", 3 LEDs	60mA	50
M1257R	Red 2.5", 3 LEDs	60mA	50
M1257GB	2.5" Grommet flush mount	N/A	100
M1259GBC	2.5" closed back grommet	N/A	50
M1255P	2 wire plug double seal	N/A	50

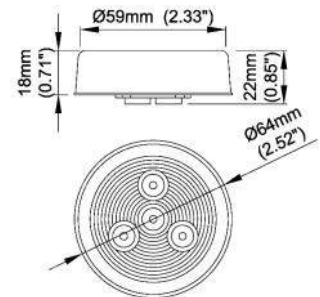

Meets FMVSS 108

All Nortech LED vehicle lighting meets FMVSS 108.
OEM Quality at a competitive price.
Ask about our kits and poly bag programs

CLEARANCE AND MARKER LAMPS | REFLECTORS

M12572



P2

F4

12V

2.5" "FLEET 2 LED" CLEARANCE AND MARKER LAMPS

Sonically sealed waterproof design. Uses P10 plug. Meets FMVSS108/SAE requirements

P/N	DESCRIPTION	AMPS	CTN
M12572A	Amber 2.5" fleet 2 LED uses PL10 plug	50mA	50
M12572R	Red 2.5" fleet 2 LED Clearance/Marker	50mA	50

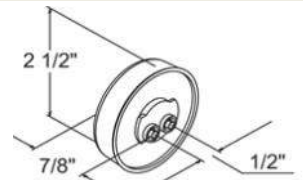

Meets **FMVSS 108**

M1259



AP2

12V

2.5" CLEARANCE AND MARKER LAMPS

Sonically sealed waterproof design with reflex reflector. Uses P10 plug. Meets FMVSS108/SAE requirements.

P/N	DESCRIPTION	AMPS	CTN
M1259A	Amber 2.5" reflectorized	45mA	50
M1259R	Red 2.5" reflectorized	45mA	50
M1259GBC	Closed back grommet	N/A	50

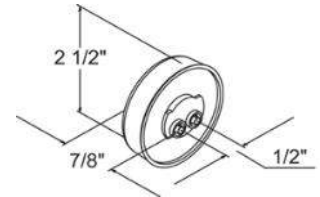

Meets **FMVSS 108**

M1239



P2

12V

3.9" MARKER LIGHT WITH REFLEX LENS

Oval LED Marker Light with Reflex Lens, light with chromed Bezel

P/N	DESCRIPTION	AMPS	CTN
M1239A	Amber; 3.9" Oval LED Marker Light	50mA	20
M1239R	Red; 3.9" Oval LED Marker Light	50mA	20
M1239C	Clear; 3.9" Oval LED Marker Light	50mA	20

Meets **FMVSS 108**

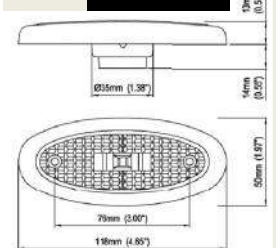

M1261



P2

Pc

13.5V

"DUO LED" FLEET 2 DIODE SEALED

Mini thin line clearance or side marker light. Sonically-sealed for waterproof, epoxy encapsulated electronics, exiting lead wire version.

P/N	DESCRIPTION	AMPS	VOLTAGE	CTN
M1261A	Amber; 3.74"	60mA	13.5V	50
M1261R	Red; 3.74"	60mA	13.5V	50
M1261BGP	Grey bracket with plug			50

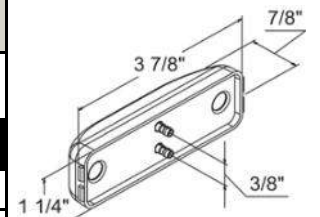

Meets **FMVSS 108**

M1290



P2

F4

12V

"UNE LED" FLEET 1 DIODE

Epoxy encapsulated electronics, suitable in grommet, bezel, flange. Sonically-sealed for waterproof, available in flush mount or surface mount.

P/N	DESCRIPTION	AMPS	CTN
M1290A	Amber; 2.5"	23mA	50
M1290R	Red; 2.5"	23mA	50
M1290GB	Grommet		50

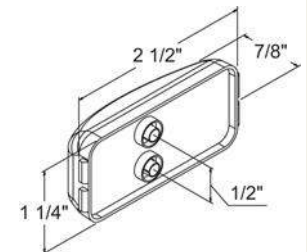

Meets **FMVSS 108**

R1510



AP2

12V

OVAL QUICK-MOUNT REFLECTOR

4.375" x 1.875" Oval Quick-Mount Reflector Meets all DOT/SAE requirements

P/N	DESCRIPTION	CTN
R1510A	Amber; 4.375"	200
R1510R	Red; 4.375"	200

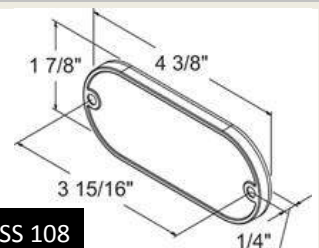

Meets **FMVSS 108**

REFLECTORS AND STOP, TAIL, TURN LIGHTS

R1515

AP2

12V

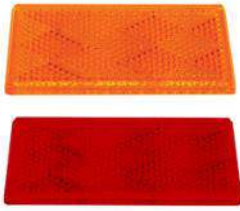

RECTANGULAR QUICK-MOUNT REFLECTOR

3.125" x 1.437" Rectangular Quick-Mount Reflector
Meets all DOT/SAE requirements

P/N	DESCRIPTION	CTN
R1515A	Amber; 3.125"	100
R1515R	Red; 3.125"	100

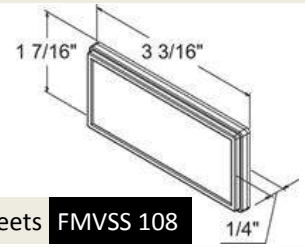

Meets FMVSS 108

S1472

P2

12V



6" OVAL SEALED STOP, TURN AND TAIL LIGHT

10 LED circle optics with ripple pattern design on lens, sonically sealed for waterproof, epoxy encapsulated electronics, available in various versions including connector, flange or exit lead wire models, suitable for horizontal or vertical orientation.

P/N	DESCRIPTION	AMPS	CTN
S1472A	Amber lens	28mA/40mA	20
S1472R	Red lens	28mA/40mA	20
S1472GB	Grommet	N/A	25
S1472P	3-way pigtail right angle 10"	N/A	100
S1413P	3-way pigtail straight plug	N/A	100

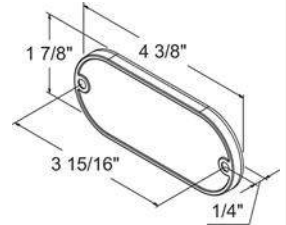

Meets FMVSS 108

S1478R

P2

F4

12V



6" FLUSH MOUNT WITH BRACKET, OVAL SEALED STOP, TURN, TAIL LIGHT

10 LED circle optics with ripple pattern design on lens, sonically sealed for waterproof, epoxy encapsulated electronics, with black flange, suitable for horizontal or vertical orientation, for over 80" application.

P/N	DESCRIPTION	AMPS	CTN
S1478R	Red	23mA/33mA	10

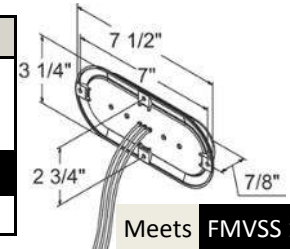

Meets FMVSS 108

B3922C

AP2

12V



6" OVAL BACK-UP LIGHT

10 diodes pattern design with shining and smooth interior chrome reflector, features SMD type of LED, clear lens, sonically sealed for waterproof, suitable for horizontal or vertical orientation, connector version.

P/N	DESCRIPTION	AMPS	CTN
B3922C	Clear	27.5mA	10

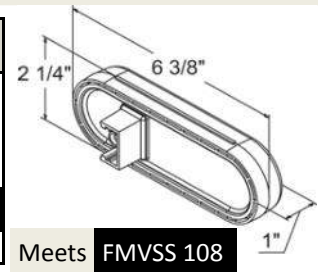

Meets FMVSS 108

S1413

AP2

12V



4" ROUND 7 DIODE STOP, TAIL, TURN LIGHT

7 diodes pattern design with shining interior chrome reflector, unique optics design in the center of lens, sonically sealed for waterproof, epoxy encapsulated electronics.
4.29"

P/N	DESCRIPTION	AMPS	CTN
S1413R	Red	15mA/150 mA	10
S1413GB	Grommet	N/A	100

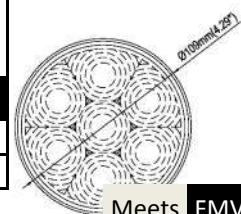
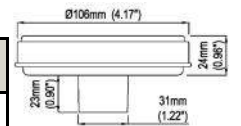

Meets FMVSS 108

Did you know?

All Nortech LED vehicle lighting has a 5 year warranty on LEDs.

More reflectors.
See page 30 for our
EvolutionE reflectors



S1443

AP2
12V



4" ROUND 10 DIODE SEALED STOP, TAIL, TURN LIGHT			
10 LED circle optics with ripple pattern design on lens, sonically sealed for waterproof, epoxy encapsulated electronics, available in various versions including connector, flange or exit lead wire models, for over			
P/N	TYPE	AMPS	CTN
S1443A	Amber	14mA/25mA	20
S1443R	Red	14mA/25mA	20
S1413GB	Grommet	N/A	100
S1472P	Pig tail	N/A	100

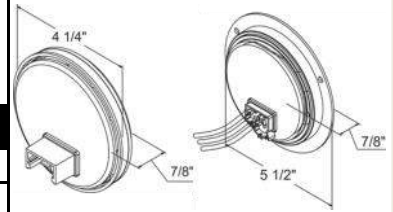

Meets FMVSS 108

B1343C

P2
F4
12V



4" ROUND SEALED BACK-UP LIGHT			
10 diodes pattern design with shining and smooth interior chrome reflector, features SMD type of LED, clear lens, sonically sealed and waterproof.			
P/N	DESCRIPTION	AMPS	CTN
B1343C	Clear, Acrylic lens, ABS housing, SMD LED	25mA	50

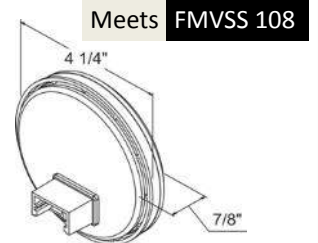

Meets FMVSS 108

S1479R

AP2
12V



17" SLIM LINE LED BAR			
<ul style="list-style-type: none"> • Single row 17"x 3/8" LED bar, S/T/T and ID bar • Sonically sealed and waterproof, 16 1/8" mounting centres • Stop, Tail, Turn, and third brake light • Hard wired with separate ground wire 			
P/N	DESCRIPTION	COLOUR	CTN
S1479R	Slim Bar	Red	50

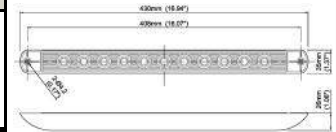

Meets FMVSS 108

L1031C

AP2
12V



LED MINI LICENSE LIGHT				
<ul style="list-style-type: none"> • 6 LEDs of super bright 5mm type, long life span up to 100,000 hours. • Circuit board completely sealed by epoxy to ensure it is water proof • Meets DOT FMVSS 108/SAE requirements 				
P/N	DESCRIPTION	COLOUR	AMPS	CTN
L1031C	12V; Chrome	White	40mA	50

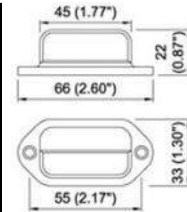

Meets FMVSS 108

<p>M1255GB 2" Grommet flush mount</p>	<p>M1256GBC 2" closed back grommet for 2" light</p>	<p>M1259GBC 2.5" closed back grommet</p>	<p>M1290GB 2.5" rectangle grommet</p>	<p>M1255P 2 wire double seal plug</p>
<p>S1413GB 4.3" grommet</p>	<p>S1472GB 6" grommet</p>	<p>S1413P 3-way pigtail straight plug</p>	<p>S1472P 3-way pigtail right angle 10"</p>	<p>S2451P Weather tight plug</p>

INCANDESCENT VEHICLE LIGHTING

SI1445R

12V



4" ROUND SEALED STOP, TURN & TAIL LIGHT

P/N	DESCRIPTION	AMPS	CTN
SI1445R	Red stop/tail light	2.1 amp	50

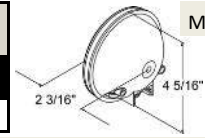

Meet FMVSS 108

SI1445A

12V



4" ROUND TURN AND SIGNAL AMBER LIGHT

P/N	DESCRIPTION	AMPS	CTN
SI1445A	Rear Amber turn signal light	2.10 amps	50

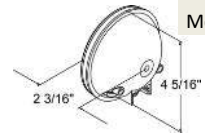

Meet FMVSS 108

SI1470A

SI1470R

12V



6" OVAL SEALED STOP, TURN & TAIL LIGHT

P/N	DESCRIPTION	AMPS	CTN
SI1470A	Amber stop/tail light only	2.10 amps	50
SI1470R	Red stop/tail light	2.10 amps	50

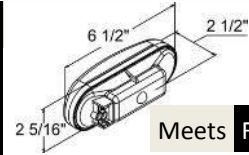

Meets FMVSS 108

SI1408

SI1409

12V



COMBINATION TRAILER STOP, TAIL, TURN AND LICENSE LIGHT

P/N	DESCRIPTION	AMPS	CTN
SI1408	RH light	2.10 amps	50
SI1409	LH light w/license	2.10 amps	50

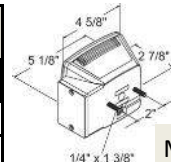

Meets FMVSS 108

BI1910C

BI19110C

12.8V

AP2



SEALED BACK-UP LIGHT

P/N	DESCRIPTION	AMPS	CTN
BI1910C	OVAL Clear back-up light; 6"	2.10 amps	50
BI19110C	ROUND Clear back-up light; 4"	2.10 amps	50

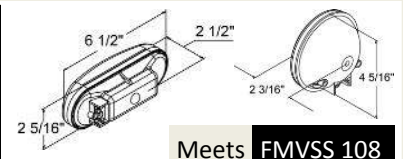

Meets FMVSS 108

MI1238A

MI1238R

14V

AP2



COMBINATION OBLONG SIDE MARKER LIGHT W/REFLEX

P/N	DESCRIPTION	AMPS	CTN
MI1238A	Amber	0.33 amps	50
MI1238R	Red	0.33 amps	50

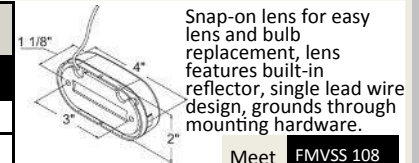

Snap-on lens for easy lens and bulb replacement, lens features built-in reflector, single lead wire design, grounds through mounting hardware.

Meet FMVSS 108

MI1253A

MI1253R

14V

P2



2" ROUND SEALED LIGHT

P/N	DESCRIPTION	AMPS	CTN
MI1253A	Amber	0.33 amps	50
MI1253R	Red	0.33 amps	50

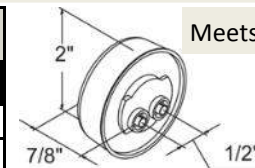

Meets FMVSS 108

MI1255A

MI1255R

14V

P2



2 1/2" ROUND CLEARANCE SEALED LIGHT

P/N	DESCRIPTION	AMPS	CTN
MI1255A	Amber	0.33 amps	50
MI1255R	Red	0.33 amps	50

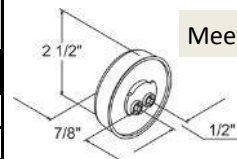

Meets FMVSS 108

MI1293R

13.5V

P2

PC



SUBMERSIBLE ID BAR (OVER 80")

P/N	DESCRIPTION	AMPS	CTN
MI1293R	Red bar; PC rated	0.33 amps	50

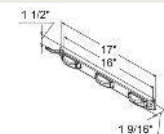

Meets FMVSS 108

TI2329K



TRAILER LIGHT KIT

P/N	DESCRIPTION	CTN
TI2329K	1pc LH light w/license + 1pc RH light + 1pc flexible license bracket + two amber side marker light + 25ft trailer harness + Hardware kit 1set	20

The trailer light kit includes complete components to mount and install.

90102C



3" LED MINI DOME COURTESY LIGHT						
<ul style="list-style-type: none"> White or Chrome surface mount, 3" mini dome & courtesy lights. Designed for overhead or side-mounting. 6 SMD LEDs, Mini LED Dome Lamp 						
P/N	TYPE	VOLTAGE	AMP	LUMEN	CTN	
90102C	Chrome	12-24V	0.06A@12V; 0.33A@24V	42lm	25	
90102W	White	12-24V	0.06A@12V; 0.33A@24V	42lm	25	

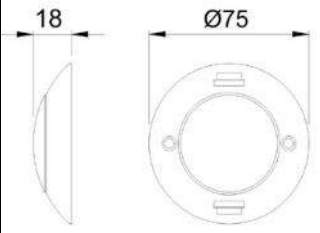

90102W



90103W



5.6" LED DOME LIGHT						
LED dome light designed for general illumination, for overhead or bulkhead, surface mount. White plastic construction with SMD LED chips with switch.						
P/N	TYPE	VOLTAGE	AMP	LUMEN	CTN	
90103W	SMD LEDs, LED Dome Lamp	12V-28V	0.315A@12V; 0.166A@24V	600lm; 6W	20	

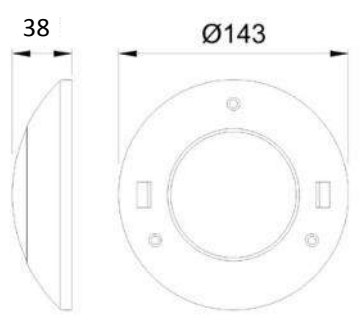

3060P



UNIVERSAL CAR & TRUCK LED COURTESY + DOME LIGHT KIT						
<ul style="list-style-type: none"> LED Car Interior Courtesy & Dome light kit. Replaces your incandescent dome and courtesy light bulbs with an LED panel that is eco friendly, has a long life of 90,000 hours and saves your vehicles battery. Easy to install: universal design with 6 different adapters to fit most foreign + domestic vehicles. Open lens of the dome lights and remove original bulbs. Choose included adapter that is similar to the original bulb, connect LED to adapter, test by turning on dome light, affix with self adhesive tape (included) on back of LED to the vehicle. 						
P/N	TYPE	VOLTAGE	AMP	LUMEN	CTN	
3060P	Courtesy lamp replacement Kit	12V DC, 5 adapters	0.14A@112V	120lm	200	



90104



INTERIOR SWIVEL MOUNT LED BAR LIGHTS						
P/N	TYPE	VOLTAGE	AMP	LUMEN	CTN	
90104	8.9" 9 SMD LEDs, Interior Swivel Lamp	12-24V	0.05A@12V; 0.038A@24V	70lm	20	
90105	18.5" 30 SMD LEDs, Interior Swivel Lamp	12-24V	0.102A@12V; 0.086A@24V	210lm	20	

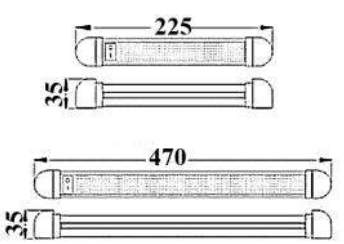

90105

DOCUMENT HOLDERS AND MANIFEST BOXES

PERMIT HOLDER

PART NUMBER	671-10100
DIMENSIONS	5x6 x1.62"
LBS	0.33
CTN	50



Easy Installation, Moisture resistant, Smoked poly carbonate lens, spring clip inside to hold documents in place

SECURITY BOX; SPACE AGE PLASTIC CONSTRUCTION

PART NUMBER	671-10350
DIMENSIONS	5.25x7x2"
LBS	1
CTN	25



Easy Storage device and Water proof protection of licenses, certificates. Easy installation, Re-usable poly bag for registration.

TUBE DOCUMENT HOLDER

PART NUMBER	671-10150
DIMENSIONS	1.5x9" ID:1.5"
LBS	0.5
CTN	25



Water resistant Tube style holder with rubber end caps.

LARGE RECORD BOX

PART NUMBER	671-10500
DIMENSIONS	11.5x16x2"
LBS	3
CTN	25



Heavy duty construction, large record box;

MANIFEST BOX

PART NUMBER	671-10200
DIMENSIONS	8x13x1.5"
LBS	1
CTN	25



For all Permits, Manifests, Logs and Registration. Waterproof protection for all contents.

THIN RECORD BOX

PART NUMBER	671-10550
DIMENSIONS	10x15x1.25"
LBS	2
CTN	25



Heavy duty construction, Triple latch closure with dry shelf. Large Thin Record box; Protection for all manifests, permits, and registration. Designed to mount on exterior post trailers and containers.

DIE-CAST ALUMINUM SECURITY BOX

PART NUMBER	671-10300
DIMENSIONS	5.25x7x2"
LBS	1
CTN	25



Waterproof storage of all vehicle documents and permits.

CABLE TIES



HD Dupont Nylon Cable Tie

Stainless Steel Cable Tie

HD DUPONT (USA) NYLON CABLE TIE (WHITE)

P/N	LENGTH	WIDTH	TESILE STRENGTH
TS-1004W	4" (100mm)	0.95" (20.5mm)	18lbs (8kgs)
TS-1008W	8" (200mm)	1.94" (49.5mm)	50lbs (22kgs)
TS-1011W	11" (280mm)	.189" (4.8mm)	50lbs (22kgs)
TS-1014W	14" (360mm)	.189" (4.8mm)	50lbs (22kgs)
TS-1108W	8" (200mm)	.3" (7.6mm)	120lbs (55kgs)
TS-1114W	14" (305mm)	.3" (7.6mm)	120lbs (55kgs)
TS-1121W	21" (540mm)	.3" (7.6mm)	120lbs (55kgs)
TS-1132W	32" (810mm)	.350" (9mm)	175lbs (80kgs)

HD DUPONT (USA) NYLON CABLE TIE (BLACK)

P/N	LENGTH	WIDTH	TESILE STRENGTH
TS-1004B	4" (100mm)	0.95" (20.5mm)	18lbs (8kgs)
TS-1008B	8" (200mm)	1.94" (49.5mm)	50lbs (22kgs)
TS-1011B	11" (360mm)	.189" (4.8mm)	50lbs (22kgs)
TS-1014B	14" (360mm)	.189" (4.8mm)	50lbs (22kgs)
TS-1108B	8" (200mm)	.3" (7.6mm)	120lbs (55kgs)
TS-1114B	14" (305mm)	.3" (7.6mm)	120lbs (55kgs)
TS-1121B	21" (540mm)	.3" (7.6mm)	120lbs (55kgs)
TS-1132B	32" (810mm)	.350" (9mm)	175lbs (80kgs)

STAINLESS STEEL CABLE TIES

P/N	LENGTH	WIDTH	TESILE STRENGTH
TSS-1010	10" (260mm)	0.18" (4.6mm)	200lbs (90kgs)
TSS-1014	14" (360mm)	0.18" (4.6mm)	200lbs (90kgs)
TSS-1110	10" (260mm)	0.31" (7.9mm)	350lbs (160kgs)
TSS-1114	14" (360mm)	0.31" (7.9mm)	350lbs (160kgs)

NEONSPEC TIES

500 ASSORTED CABLE TIES

P/N	LENGTH	COLOUR	T STRENGTH	QTY
TSB-500K	4"	Earth	18lbs (8kgs)	100
	4"	Pink	18lbs (8kgs)	100
	8"	Fl. Blue	50lbs (8kgs)	100
	8"	Fl. Green	50lbs (8kgs)	100
	8"	Fl. Orange	50lbs (8kgs)	100

TSB-600K

600 ASSORTED CABLE TIES

P/N	LENGTH	COLOUR	T STRENGTH	QTY
TSB-600K	4"	Natural	18lbs (8kgs)	150
	4"	Black	18lbs (8kgs)	150
	8"	Natural	40lbs (8kgs)	100
	4"	Black	40lbs (8kgs)	100
	11"	Natural	40lbs (8kgs)	50
	11"	Black	40lbs (8kgs)	50



CABLE TIE MOUNTS

P/N	LENGTH	WIDTH	FOR CABLE TIES WIDTH UP TO
TSM-2020	19mm (3/4")	19mm (3/4")	3.6mm (0.140")



SCREW MOUNT

P/N	LENGTH	WIDTH	HEIGHT	DIAMETER	FOR CABLE TIES WIDTH UP TO
TSM-2401	15.2 (600")	9.4mm (.370")	6.80mm (0.267")	3.30mm (0.130")	4.8mm (0.189")



TSB-500K



TSM-2020

TSM-2401

NORTECH VIKING STRIP & ROPE LIGHTING

IP67 12V



N75050W

Cut to length on cutline

12V LED STRIP LIGHTING WITH ADHESIVE BACK/CONNECTOR CLIPS

P/N	SIZE	COLOUR	AMPS	LUMEN
N75050W-18	18"(1.5')	White	0.4	370
N75050W-24	24"(2')	White	0.5	480
N75050W-36	36"(3')	White	0.8	720
N75050W-48	48"(4')	White	1.1	950
N75050W-5M	5m(16.4')	White	4.5	785lm/m

- Other colours are available on special orders.

IP67 12V



N75050W-50

N75050RGB

12V LED STRIP LIGHTING IN 50M ROLLS (With adhesive back)

P/N	SIZE	COLOUR	AMPS	LUMEN
N75050W-50M	50m(164')	White	0.9amp/m	785lm/m
N75050RGB-50M	50m(164')	Multi-colour	0.9amp/m	785lm/m

- Other colours are available on special orders.
- White N75050 strip can only be used in maximum of 5m lengths.

IP67 12V



N75050KRGB



COMPLETE 12V RGB STRIP LIGHT KIT

P/N	SIZE	COLOUR	AMPS	LUMEN
N75050KRGB	5m(16.4')	Multi-colour	0.9amp/m	785lm/m

- Includes 5m RGB strip lighting, remote controller 12V Adapter (plugs into 110V).

IP67 12V



N74050KW



Cut to length every 3 diodes

12V ROUND LED ROPE LIGHT KIT

P/N	TYPE	COLOUR	AMPS	LUMEN
N74050KW	16m(52.5'); Kit	White	0.9amp/m	785lm/m

- Led rope light, with everything you need. (10) Centre connectors, (10) end caps, (50) clips, (10) power cables. VU Pack
- 200lm per meter (3.3"), 360 degree viewing angle

Available in bulk 50m roll

N74050W-50M	50m(164')	White	0.9amp/m	785lm/m
N74050WW-50M	50m(164')	Warm White	0.9amp/m	785lm/m

Mounting Clips

Rope light power Cable

End caps

Centre connectors



N70450-1



N70450-2



N70450-3



N70450-4

IP67 12V



N75051



12V ADAPTER

P/N	VOLTAGE	DESCRIPTION
N75051	12V	110 to 12V adapter plugs in the wall

IP67 110V-120V



N74110W

N74110WW

N74110RGB-50M

110—120V LED ROPE LIGHTING KIT/50m SPOOL

Includes 50m spool with wall adapter and connector kit

P/N	SIZE	COLOUR	AMPS	LUMEN
N74110W	50m (164')	Cool White	0.9amp/m	785lm/m
N74110WW	50m (164')	Warm White	0.9amp/m	785lm/m
N74110RGB-50M	50m (164')	Multi-colour	0.9amp/m	785lm/m



Mounting hardware included



AC/DC ADAPTOR



POWER SUPPLY



SWIVEL BRACKETS



U BRACKET with SCREWS



Connectors to connect multiple VIKING Rigid Bars

VIKING LED RIGID BARS; A "LIGHT SOURCE" FOR INTERIOR OR EXTERIOR USE

- New Viking LED Rigid bar lights can be used for automotive and work truck applications to light compartments or where ever you need light. Great for industrial use underneath mezzanines or to replace fluorescent tube lights. Great for home use as accent and cabinet or valance lighting. The Viking rigid bar is a waterproof 12 Volt light source that has many applications.
- Uses: Tool box or truck box compartments, under cabinets, RV, home & Industrial. Mezzanines rack lighting, strip lighting can replace fluorescent tubes. Good for camping and Display cases.
- Specs: IP68, 12v, True White SMD LED chips, also available in RGB multi-coloured.
- Many different mounting options. View Angle: 120; Aluminum housing, Aluminum PCB/MC PCB
- Connect with a 12V battery for outdoor/indoor use or use one of our 110V AC to 12V power supply.
- Life Span: 50,000 hrs.; 3 Year Warranty

P/N	SIZE	LUMEN	DESCRIPTION	CTN
N15630W-12	12" (0.3m)	405lm	True white SMD LED chips	50
N15630W-20	20" (0.5m)	675lm	True white SMD LED chips	50
N15630RGB-20	20" (0.5m)	675lm	RGB, Multi-coloured SMD LEDs	50
N15630W-24	24" (0.6m)	810lm	True white SMD LED chips	50
N15630W-39	39" (1m)	1350lm	True white SMD LED chips	50
N15630RGB-39	39" (1m)	1350lm	RGB, Multi-coloured SMD LEDs	50
N15630W-48	48" (1.2m)	1620lm	True white SMD LED chips	50
N15631	115V AC Wall adapter to run 12V light bars or light strings			
NLPV-20-12	Class 2 Power Supply, Input 100-240VAC, output 12V, draws 1.67 amps. IP67, cRJ			
N15630FP	Additional female 7.5" connector to connect to any Viking Rigid Bar			
N15630MP	Additional Male 7.5" connector to connect to female end on any Viking Rigid Bar			

Single channel Application



Multiple channel Application



*For WARM White LED lights please add "W" at the end of the desired part number eg. N15630W -> N15630WW



Dynamic wall lighting



Truck compartments



Viking rigid bars under the storage cover



Restaurant



Ceiling lighting



Truck Boxes



Displays



N16237



string light or you can cut them as you need them. Need one module , 3 modules or any combination cut them as you need them off the 20 module kit, or use the whole string. Also use as interior lighting on RV's & trucks. Great compartment, trunk and truck box lighting. Great for home use; Interior accent or under cabinet lighting, deck, cottage workshop lighting (1 Kit replaces 2 four foot fluorescent tubes), light up a crawl space or closet. . Only for use with a 12 Volt power source. Save Time & Money! use a Viking module

VIKING MODULE 12 VOLT STRING LIGHTS
 Hundreds of uses, indoor/outdoor UL & **ULc approved** weather proof IP67 Viking modules. COMES WITH A TAPE BACKING OR CAN BE MOUNTED WITH SCREWS.

WHAT ARE VIKING MODULE LEDs? LIGHT STRINGS AND INDIVIDUAL LAMPS

A kit of 20, 12 Volt LED Viking Modules, produce 1600 Lumens of light on a 11 foot light string. That's 80lm a module. You can use them as a

LED VIKING MODULE

P/N	COLOUR	VOLTAGE	CTN
N16237A	Amber	12V	20
N16237B	Blue	12V	20
N16237G	Green	12V	20
N16237R	Red	12V	20
N16237W	White	12V	20
N16237WW	Warm White	12V	20
N16237W-24V	Warm White	24V	20



N17020

N17030



PORTABLE LED WORK LIGHT with plug

Great for contractor and shop use. 110V LED flood light with stand & handle

P/N	WATTS	LUMENS	L	W	Depth	CTN
N17020	20W	1440 lm	7"	5.5"	5"	4
N17030	30W	2160 lm	9"	5.5"	5"	4

N17103S



VIKING TOUGH PORTABLE LED SHOP LIGHT

- 110-120V AC, 50-60Hz,
- Aluminum body, IP54

P/N	WATTS	LUMENS	L	W	Depth	CTN
N17103S	12W	900 lm	8"	7"	5"	4



N17310RS

N17320RS

N17330RS



N17230DS



N17110

N17120

N17130

N17150



N17210

N17220

N17230

N17250



N17310RS

N17330RS

MULTI-FUNCTIONAL RECHARGEABLE LED WORK LIGHT							
LED Work Light with stand and handle, great for shop and home use.							
P/N	TYPE	Beam	WATTS	LUMENS	CHARGING TIME	WORKING TIME	CTN
N17310RS	Flood Light	120°	10W	600lm	2.5h	Up to 8h	4
N17320RS	Flood Light	120°	20W	1200lm	5h	Up to 6h	4
N17330RS	Flood Light	120°	30W	1800lm	5h	Up to 6h	4



TWIN HEAD LED WORK LIGHT WITH TRIPOD AND REMOVABLE TOP							
<ul style="list-style-type: none"> 2-Headed LED Tripod Work light has a sturdy tubular metal stand that telescopes to 45in.H to put light at the perfect height for almost any job. Also, the 2 light heads can be taken off and used off the tripod. ULc listed. Aluminum body; comes with a tripod and two N17103S Work lights. UL plug, with switch 110-120V AC, IP54 Super bright LED bulbs stay cool to the touch, are very efficient and provide up to 30,000 hrs. of bulb life – at an average of 8 hours of use per day, that adds up to over 10 full years of service per bulb! 2 adjustable angle light heads with aluminum housing add versatility Tripod features one adjustable leg to provide solid setup on uneven surfaces Sure-grip foam handle for portability with carrying comfort Includes durable 8-ft., 18 AGW/3C all-weather cable 							
P/N	WATTS	LUMEN	L	W	DEPTH	MAX HEIGHT (tripod +Lights)	CTN
N17230DS	2x12W	1800 lm	5"	8"	7"	64"	1



WALL BRACKET MOUNT LED FLOOD LIGHT								
Outdoor rated LED flood light with mounting bracket. 110V—120V IP65 Aluminum Body Working Lifetime of 50000 hours. GS, CE, RoHS, EMC, LVD, ETL, SAA								
P/N	TYPE	BEAM	WATTS	LUMEN	L	W	DEPTH	CTN
N17110	Flood Light	120°	10W	720 lm	4.5"	3.5"	4"	4
N17120	Flood Light	>120°	20W	1440 lm	7"	5.5"	5"	4
N17130	Flood Light	120°	30W	2160 lm	9"	7"	5.5"	4
N17150	Flood Light	120°	50W	3600 lm	11.5"	9.5"	5.5"	2



WALL BRACKET LED FLOOD LIGHT WITH SENSOR									
Outdoor flood light with sensor with mounting bracket. 100V—120V IP44 Sensor range: 0-180° Aluminum Body Working Lifetime of 50000 hours. GS, CE, RoHS, EMC, LVD, ETL, SAA									
P/N	TYPE	BEAM	WATTS	LUMEN	L	W	DEPTH	TOTAL HEIGHT WITH SENSOR	CTN
N17210	Flood Light	120°	10W	720 lm	4.5"	3.5"	4"	6.5"	4
N17220	Flood Light	120°	20W	1440 lm	7"	5.5"	5"	8.5"	4
N17230	Flood Light	120°	30W	2160 lm	9"	9.5"	5.5"	12.5"	4
N17250	Flood Light; IP65	120°	50W	3600 lm	11.5"	9.5"	5.5"	12.5"	2



N18120T

N18180T



LED AREA FLOOD LIGHT									
IP65 Aluminum Body CE, GS, SAA, RoHS Working Lifetime of >50000 hours									
P/N	TYPE	BEAM	WATTS	LUMEN	L	W	DEPTH	CTN	
N18120T	Flood Light	120°	2x60W	8640 lm	18"	12"	8"	2	
N18180T	Flood Light	120°	3x60W	12960 lm	18"	12"	8"	2	

N18810W

N18830W

N18850W



FROST PROOF LED									
IP65 Aluminum Body CE, GS, SAA, RoHS Working Lifetime of >50000 hours 110V-120V									
P/N	TYPE	BEAM	WATTS	LUMEN	L	W	DEPTH	CTN	
N18810W	Flood Light	120°	10W	720 lm	6"	7"	2.5"	4	
N18830W	Flood Light	120°	30W	2160 lm	9.5"	11.5"	3"	4	
N18850W	Flood Light	120°	50W	3600 lm	12"	15"	4"	4	

N18100

N18150

N18200



MEGA WATTAGE LED FLOOD LIGHTS							
<ul style="list-style-type: none"> Powerful Flood Light; features Philips LUMILEDS SMD3535 2D LED as the light source. High heat conductivity, low luminous decay, pure light color and no ghosting. The heat From the LED is removed through the heat dissipation wing and also by air ventilation. This ensures 50,000 hours life-span for the LED. DLC listed, power-saving compare with sodium lights, it can save 60% in costs. IP65 Aluminum Body + Glass CCT: 5700K. *347W available; add -347 to part number 							
P/N	PACKAGING SIZE (LxWxH)	BEAM	WATTS	VOLTAGE	LUMEN	TEMPERATURE	CTN
N18100	15" x 14.5" x 10.6"	120°	100W	AC 100-277V	8500 lm	-35--+50°C	1
N18150	17" x 14.7" x 11"	120°	150W	AC 100-277V	12750 lm	-35--+50°C	1
N18200	20" x 18" x 12"	120°	200W	AC 100-277V	17000 lm	-35--+50°C	1



N20100

N20150

N20200



- UL&DLC listed
- Meanwell-HLG series driver
- Patented cooling system

LED HI-BAY WAREHOUSE LIGHTING							
<ul style="list-style-type: none"> Industrial quality light with lower amp draw and higher power than traditional warehouse lights. Our 200W LED light replaces 700W traditional warehouse light (MH, HPS). CUL and DLC approved IP65 Aluminum alloy body PF>0.9 CRI>80 CCT: 5700K *347W available; add -347 to part number 							
P/N	PACKAGING SIZE (LxWxH)	BEAM	WATT	VOLTAGE	LUMEN	TEMPERATURE	CTN
N20100	19.7" x 19.7" x 16.5"	120°	100W	AC 100-277V	8500 lm	-25--+50°C	1
N20150	29.5" x 20.9" x 16.5"	120°	150W	AC 100-277V	12750 lm	-25--+50°C	4
N20200	29.5" x 20.9" x 17.7"	120°	200W	AC 100-277V	17000 lm	-25--+50°C	4

INDUSTRIAL GRADE LIGHTS

CREE



CREE

LED PARK/ PARKING LOT LIGHT SHOE BOX STYLE



16.5" L x 16.5" W x 6.8" H, 7.8 kg



- Positive cooling technology with fan
- Heat and shock resistant
- Angle: 120°
- Die-cast aluminum housing
- High voltage 347V-480V. Add HV to part number
- All lights are 5000K Cool White

LED PARK/ PARKING LOT LIGHT SHOE BOX STYLE

P/N	VOLTAGE	INPUT POWER	LUMEN
NSB100	100V—277V	75W	7500 Lm
NSB120	100V—277V	120W	11140 Lm
NSB140	100V—277V	140W	13000 Lm
NSB160	100V—277V	160W	14880 Lm
NSB200	100V—277V	200W	18600 Lm

• WW available on request

WALL PACKS AND MINI WALL PLUGS



NWP04
NWP06
NWP06HV



NWP01
NWP02



NWP09



NWP11
NWP11HV



- Heat and shock resistant
- High power CREE LEDs
- Die-cast aluminum and glass
- AC100—277V; 5000K Cool White; IP65; 120°

LED PARK/ PARKING LOT LIGHT SHOE BOX STYLE

P/N	SIZE LxWxH	WATT	LUMEN
NWP01	10.8" x 6.7" x 5.1"	20W	1650 Lm
NWP02	12.9" x 7.8" x 5.5"	30W	2400 Lm
NWP04	13.1" x 9.5" x 7.5"	40W	4000 Lm
NWP06	13.1" x 9.5" x 7.5"	60W	5500 Lm
NWP06HV	13.1" x 9.5" x 7.5"	80W	7500 Lm
NWP09	16.9" x 9.4" x 9.3"	100W	8000 Lm
NWP11	16.9" x 9.5" x 12.7"	125W	10500 Lm
NWP11HV	16.9" x 9.5" x 12.7"	125W	10500 Lm

CANOPY LIGHTS



- Heat and shock resistant
- Die-cast aluminum and glass
- High voltage available 347V-480V. Add HV to part number
- All lights are 5500K

CREE



CANOPY LIGHTS

P/N	SIZE LxWxH	KG	WATT	LUMEN
NCP04	8.8" x 8.8" x 8.9"	4.5	40W	3500 Lm
NCP05	12.4" x 12.4" x 9.6"	7.3	60W	5500 Lm
NCP09	12.4" x 12.4" x 9.6"	7.5	80/85W	7500 Lm
NCP11	12.4" x 12.4" x 9.6"	7.8	120W	10050 Lm



LED STREET LIGHTS

- High power CREE LEDs
- AC100—277V; 200-480V5000K
- CCT: 2700-6000K; IP68;
- -35°C +50°C
- 50,000 hours life time



LED STREET LIGHTS

P/N	SIZE LxWxH	POWER FACTOR	WATT	CRI	LUMEN
NSL302	19.7" x 12.6" x 4.98"	>0.9	60W	>70	5400 Lm
NSL313	21.9" x 12.6" x 4.98"	>0.9	80W	>70	7200 Lm
NSL303	22.3" x 12.6" x 4.98"	>0.9	100W	>70	9000 Lm
NSL304	24.8" x 12.6" x 4.98"	>0.9	120W	>70	11000 Lm
NSL305	26.4" x 12.6" x 4.98"	>0.9	160W	>70	14500 Lm
NSL306	28.7" x 12.6" x 4.98"	>0.9	200W	>70	18000 Lm
NSL308	33.2" x 12.6" x 4.98"	>0.9	250W	>70	22500 Lm
NSL310	40" x 12.6" x 4.98"	>0.9	300W	>70	25000 Lm

RETRO FIT KITS



- High power CREE LEDs
- 5500k
- Available in high voltage 347V-480V. Add HV to part number
- 70,000 hours life span
- Standard AC100—277V
- High voltage available 347V-480V. Add HV to part number

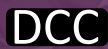

RETRO FIT KITS

P/N	DIM	WATT	LUMENS	REPLACES
NRT35	Yes	35W	3311 Lm	100W MH/HPS
NRT45	Yes	45W	4260 Lm	125W MH/HPS
NRT65	Yes	65W	6150 Lm	175W MH/HPS
NRT75	Yes	75W	7100 Lm	250W MH/HPS
NRT105	Yes	105W	10000 Lm	350W MH/HPS
NRT120	Yes	120W	12000 Lm	400W MH/HPS
NRT150	Yes	150W	14500 Lm	450W MH/HPS
NRT200	Yes	200W	19000 Lm	600W MH/HPS
NRT400	Yes	400W	38000 Lm	1000W MH/HPS

SMART LED TOUCH LIGHT



TOUCH DIM—STEP



ELEGANT DESIGN, INTELLIGENT, ADVANCED, EASY TO USE



LED TOUCH CONTROL LIGHT

- Switch function: Power on and off using touch sensitive sensor
- Dimming function: takes few seconds to brighten or dim the light by simply tapping on the touch switch for desired level of lighting.
- Memory function: Automatically remembers the last setting even when you turn the light off and on. Brightness level will stay the same.
- Aluminum body; plugs into the wall with a 12V adapter

P/N	COLOUR	VOLTAGE	SIZE	LUMEN
N19116CW	Cool White	DC 12V	2' (61.4cm)	1100 lm
N19116WW	Warm White	DC 12V	2' (61.4cm)	1100 lm

N19113CW
N19113WW
N19116CW
N19116WW



N44000WW
N46000TW



4" LED POT LIGHT RETRO FIT KITS

- Pot lights for ceilings, retro fit your standard
- AC100-240V,50/60Hz / AC 100-240V| 50/60hz 0.3A | Aluminum + PC panels | 120 x 68 mm | Dimmable light | no flicker, Green and environment friendly (ROHS standards) | Working Lifetime: up to 30,000 hours

P/N	TYPE	CCT	BEAM	WATTS	LUMENS	SIZE
N44000WW	Warm White	3000K	100°	9W	540 lm	4"
N46000CW	True White	5000K	100°	9W	540 lm	4"
N64000WW	Warm White	3000K	100°	16W	950 lm	6"
N66000CW	True White	5000K	100°	16W	950 lm	6"

NPAR16
NMR16
NGU10



BEST LED

PAR 16, GU10, MR16 BEST LED By NORTECH (Dimmable)

CREE

P/N	ITEM NUMBER	WATT	LUMEN	CCT	ANGLE	VOLT	COLOR
NPAR16CW	LED7E265000K40D—CW	7	510lm	5000K	15/24/40/60°	AC 120V	Cool White
NPAR16WW	LED7E263000K40D—WW	7	450lm	3000K	15/24/40/60°	AC 120V	Warm White
NMR16CW	LED7GU105000K40D—CW	7	510lm	5000K	15/24/40/60°	AC 120V	Cool White
NMR16WW	LED7GU103000K40D—WW	7	450lm	3000K	15/24/40/60°	AC 120V	Warm White
NGU10CW	LED7MR165000K40D—CW	7	510lm	5000K	15/24/40/60°	AC/DC 12V	Cool White
NGU10WW	LED7MR163000K40D—WW	7	450lm	3000K	15/24/40/60°	AC/DC 12V	Warm White

LED LIGHT BULBS AND LED TUBE LIGHTS

NPAR



LED PAR LIGHTS (DIMMABLE)

Base: E26; UL&cUL, RoHS, FCC
 Rough service bulb
 AC 120V; Beam: 25°
NPAR20CW | NPAR20WW
 8W; 500 Lm

NPAR30CW | NPAR30WW
 14W; 850 Lm

NPAR38CW | NPAR38WW
 18W; 1200 Lm



NBR

BR LIGHTS (DIMMABLE)

Base: E26; UL&cUL, RoHS, FCC
 Rough service bulb
 AC 120V; Beam: 120°
NBR20CW | NBR20WW
 7W; 500 Lm

NBR30CW | NBR30WW
 15W; 1100 Lm

NBR40CW | NBR40WW
 22W; 1600 Lm



NRSB10

10W ROUGH SERVICE BULB

Base: E26; UL&cUL, RoHS, FCC
 Rough service bulb
 AC 110—130V
 Beam: 270°
 10W
 800—850 Lm

NBS10CW | NBS10WW



NT8418





TUBE LIGHTS

LED T8 Tube lights with internal drivers, use with most existing T8 fluorescent lights panel. UL, DLC, RoHS. Also ballast compatible that work with existing ballasts.

P/N	DESCRIPTION	WATT	LUMEN	DRIVER	CRI	VOLTAGE
NT8418BC	4FT; Ballast compatible, Dimmable	10W	1800 Lm		85	AC 110-277V
NT8418ID	4FT	18W	1800 Lm	Internal	85	AC 110-277V
NT8418ID-347	4FT	18W	1800 Lm	Internal	85	AC 347V
NT8418IDD	4FT; Dimmable	18W	2000 Lm	Internal	85	AC 110-277V
NT8436ID	4FT	36W	3600 Lm	Internal	85	AC 110-277V

* Tubes come frosted, add C to the end of part number for clear

NPL2

PANEL LIGHTS LED OFFICE CEILING LIGHT REPLACEMENT



- Voltage: AC100—277V
- Angle: 120°
- Silver Trim
- CCT: 5000K
- Dimmable

PANEL LIGHT

P/N	TYPE	SIZE LxW	INPUT	LUMEN
NPL2X240CW	Cool White	2'x 2'	40W	3250 Lm
NPL2X240WW	Warm White	2'x 2'	40W	3250 Lm
NPL2X250CW	Cool White	2'x 2'	50W	4250 Lm
NPL2X250WW	Warm White	2'x 2'	50W	4250 Lm
NPL2X450CW	Cool White	2'x 4'	50W	5100 Lm
NPL2X450WW	Warm White	2'x 4'	50W	5100 Lm
NPL2X460CW	Cool White	2'x 4'	60W	4250 Lm
NPL2X460WW	Warm White	2'x 4'	60W	4250 Lm



NORTECH INNOVATIVE PRODUCTS-Innovating the Future Today!

If there is a special application or unique opportunity or if you require assistance at any time, or would like to meet with your local rep, please contact us.

Customer satisfaction is the foundation of our business. We are committed to supply you products that exceed your expectations.

Limited Warranty: Nortech Innovative Products warrants each new product to be free from defects in workmanship and materials for a period of 1 year unless otherwise stated. LED product warranty is that they be free in defects, materials and workmanship for a period of 3 years (unless otherwise stated). The LED warranty does not cover housing, bases, enclosures. These are covered for 1 year. All Warranty applies to the original end user only, and is non transferable and is terminated upon the possession of the product by anyone other than the original owner. Product must be installed and used in accordance with normal circumstances and the manufacturers recommendations. There are no warranties expressed or implied which extend these warranty periods. Damages, the loss of use of the product, loss of time, inconvenience, commercial loss, or any other consequential damages including cost of any and all labour are not covered by the warranty.

Disclaimer: Freightliner, Volvo, John Deere are in no way affiliated with Nortech Innovative Products Inc.

PART NUMBER INDEX

1004SMD.....	37	4555A	9	6630BC	14	9056	15	9106-5	35	9305	23
1156.....	38	4555B	9	6630BG	14	9056CH	27	9106-51	35	9316.....	23
1156A.....	38	4555C	9	6630BR	14	9056MC.....	15	9106CNL.....	35	9345.....	24
1156ASMD.....	37	4555CA	9	6630BRT.....	14	9056S.....	15	9106K.....	35	9350.....	24
1156R.....	38	4650A	9	6630C.....	14	9057.....	15	9107-5.....	35	9367.....	24
1156RSMD.....	37	4650B	9	6630G.....	14	9057CH.....	27	9108-5.....	35	9369.....	24
1156SMD.....	37	4650MA.....	9	6630GRT.....	14	9057S.....	15	9109QV.....	33	9380SF.....	23
1157.....	38	4750A	10	6630R.....	14	9058.....	16	9109RV.....	33	9381SF.....	23
1157A.....	38	4941MPC.....	10	6663A-1.....	14	9058S.....	16	9111-5.....	35	9382SF.....	23
1157ASMD.....	37	5024A	5	6663A-2.....	14	9059.....	16	9111-51.....	35	9383SF.....	23
1157R.....	38	5048A	5	6663B-1.....	14	9059S.....	16	9111CNL.....	35	9384SF.....	23
1157RSMD.....	37	5060A	5	6663B-2.....	14	9060.....	16	9111K.....	35	9385SF.....	23
1157SMD.....	37	5124A	4	6663C-1.....	14	9061.....	27	9112-5.....	35	9490A.....	36
1320MA.....	10	5124MA.....	4	6663C-2.....	14	9061SB.....	27	9120.....	32	9490A-10.....	36
1320MB.....	10	5148A	5	6663R-1.....	14	9061WS.....	27	9120-2.....	32	9490KA.....	36
1325A.....	8	5148-AL.....	5	6663R-2.....	14	9062F.....	16	9120-2TC.....	33	9490KR.....	36
1325B.....	8	5160A	5	6664A-1.....	14	9062S.....	16	9124DVR.....	32	9490R.....	36
1371MA.....	10	5160-AL.....	5	6664A-2.....	14	9063.....	27	9125.....	32	9490R-10.....	36
1371MB.....	10	5441A	6	6664B-1.....	14	9064F.....	16	9125-2LV.....	33	9491A.....	36
1375A.....	8	5449A	6	6664B-2.....	14	9064S.....	16	9125-2TS.....	33	9491A-10.....	36
1375B.....	8	5459A	6	6664C-1.....	14	9065.....	16	9125-TS.....	33	9491KA.....	36
1452A.....	8	5524A	4	6664C-2.....	14	9066.....	17	9127-4.....	36	9491KR.....	36
1452HDA.....	8	5524MA.....	4	6664R-1.....	14	9066S.....	17	9128-1.....	36	9343.....	24
1452HDMA.....	8	5548A	6	6664R-2.....	14	9067F.....	17	9128-2.....	36	9343SB.....	24
1455A.....	8	5560A	6	6666A.....	14	9067S.....	17	9128S.....	36	9344H.....	24
1455MA.....	8	6103A	13	671-10100.....	47	9068.....	17	9133-87.....	29	9344L.....	24
1895A.....	38	6103B	13	671-10150.....	47	9069.....	17	9133-97.....	29	9346.....	24
1895AHP.....	37	6103C.....	13	671-10200.....	47	9069ABS.....	17	9138-97.....	29	9355.....	24
1895R.....	38	6103R.....	13	671-10300.....	47	9071CSF.....	18	9140.....	37	9356.....	24
1895RHP.....	37	6104A	13	671-10350.....	47	9071DCSF.....	18	9150.....	20	9357.....	24
1895W.....	38	6104AC.....	13	671-10500.....	47	9071SF.....	18	9165-102.....	29	9491R.....	36
1895WHP.....	37	6104B.....	13	671-10550.....	47	9072CSF.....	18	9165-87.....	29	9491R-10.....	36
194APC.....	38	6104BA.....	13	6748.....	7	9072DCSF.....	18	9165-97.....	29	9499.....	30
194ASMD.....	37	6104BC.....	13	6750.....	7	9072SF.....	18	9169-102.....	29	95200R.....	35
194ASMDL.....	37	6104C.....	13	6804A.....	7	9073CSF.....	18	9169-87.....	29	95200Y.....	35
194BSMDL.....	37	6104G.....	13	6806A.....	7	9073DCSF.....	18	9169-97.....	29	9524A.....	10
194BSMDL.....	37	6104R.....	13	6808A.....	7	9073SF.....	18	9170-102.....	29	9524B.....	10
194GSMDL.....	37	6104RB.....	13	6810A.....	7	9074CSF.....	18	9170-97.....	29	9524R.....	10
194PC.....	38	6104RC.....	13	8000.....	11	9074DCSF.....	18	9181.....	11	9525K-6.....	12
194RPC.....	38	6148A.....	11	8002.....	11	9074SF.....	18	9190.....	30	9525KA-6.....	12
194RSMD.....	37	6148B.....	11	8003.....	11	9075CSF.....	18	9199.....	30	9525KAA.....	12
194RSMDL.....	37	6148BR.....	11	90102C.....	46	9075DCSF.....	18	9200F.....	20	9525KBB.....	12
194SMD.....	37	6148G.....	11	90102W.....	46	9075SF.....	18	9200S.....	20	9525KBB-6.....	12
194SMDL.....	37	6148R.....	11	90103W.....	46	9077F.....	19	9202F.....	20	9525KOA.....	12
2115A.....	5	6149A.....	11	90104.....	46	9077S.....	19	9202S.....	20	9525KOR.....	12
2160.....	5	6149B.....	11	90105.....	46	9081.....	19	9203F.....	20	9525KYA.....	12
2512A.....	3	6149BR.....	11	904.....	38	9082.....	19	9203S.....	20	9525KYA-6.....	12
2512B.....	3	6149R.....	11	9043JD.....	34	9083.....	19	9204F.....	20	9526KOR.....	12
2512CAA-S.....	3	6150A.....	11	9046JDF.....	34	9084.....	19	9204S.....	20	9526KOR-3.....	12
2512MA.....	3	6150B.....	11	9046JDS.....	34	9085.....	19	9205B.....	21	9526KYA.....	12
2512MAA.....	3	6150BR.....	11	9048.....	26	9089SB.....	19	921.....	38	9526KYA-3.....	12
2512MB.....	3	6150R.....	11	9048C.....	26	9091.....	19	9212BS.....	21	9526OR.....	12
2512MCAA-S.....	3	6151A.....	11	9048W.....	26	9092.....	19	9212F.....	21	9526YA.....	12
2512MG.....	3	6151B.....	11	9050.....	26	9093.....	19	9212S.....	21	9541MPC.....	10
2612A.....	3	6151BR.....	11	9050-01.....	26	9094.....	19	9218BF.....	21	9704K.....	28
2612MA.....	3	6151R.....	11	9050-01HD.....	26	9100.....	31	9218BS.....	21	9703K.....	28
2616A.....	4	64120A.....	13	9050-24V.....	26	9100-1.....	33	9218F.....	21	9705K.....	28
2616CA.....	4	64120B.....	13	9050A.....	26	9100-2.....	33	9218S.....	21	9706K.....	28
2616MAA.....	4	64120C.....	13	9050B.....	26	9100-2AS.....	33	9236F.....	21	9707K.....	28
2616MCA.....	4	64120G.....	13	9050F.....	26	9100-2MC.....	33	9236S.....	21	9711K.....	28
3060P.....	46	64120OR.....	13	9050F-01.....	26	9100-2W.....	33	9246F.....	22	9713K.....	28
3156ASMD.....	37	64220AA.....	13	9050F-01HD.....	26	9100-4.....	33	9246S.....	22	9717K.....	28
3156SMD.....	37	64220AC.....	13	9050F-24V.....	26	9100TC.....	31	9260F.....	22	9721K.....	28
3157.....	38	64220BB.....	13	9050FHD.....	26	9100W.....	31	9260S.....	22	9723K.....	28
3157A.....	38	64220BC.....	13	9050FHD-1.....	34	9102.....	31	9269A.....	22	9752K.....	28
3157ALED.....	38	64220CC.....	13	9050G.....	26	9102W.....	31	9269BF.....	22	9780K.....	28
3157LED.....	37	64220G.....	13	9050HD.....	26	9102-1.....	33	9269BS.....	22	9806.....	11
3157R.....	38	64220RC.....	13	9050HD-1.....	34	9103MS.....	34	9269F.....	22	9807.....	11
3157RLED.....	38	64220RR.....	13	9050R.....	26	9103RD.....	34	9269S.....	22	9818.....	11
3157RSMD.....	37	6630A.....	14	9050W.....	26	9104MC.....	34	9290F.....	23	9820.....	11
3157SMD.....	37	6630B.....	14	9051.....	27	9104SM.....	34	9290S.....	23	AC-5001.....	25
4250A.....	9	6630BA.....	14	9052.....	15	9105.....	32	9303.....	23	AC-5002.....	25
4518A.....	9	6630BB.....	14	9053F.....	27	9105-2.....	33	9304.....	23	AC-5004.....	25

PART NUMBER INDEX

AC-5005.....25	GSV001R.....34	N15630W-2050	R1515R43	NPL2X250CW....56
AC-5006.....25	GSV002L.....34	N15630W-2450	S1413G44	NPL2X250WW ..56
AC-5007.....25	GSV002R.....34	N15630W-3950	S1413GB43	NPL2X450CW56
AC-5008.....25	HMWH.....25	N15630W-4850	S1413GB44	NPL2X450WW ..56
AC-5009.....25	L1031C.....44	N1563150	S1413P43	NPL2X460CW56
AC-5016.....25	M1211KA.....41	N16237A.....51	S1413P44	NPL2X460WW ..56
AC-5100-12525	M1211KC.....41	N16237B.....51	S1413R.....43	NRCPO554
AC-5100-1525	M1211KCA.....41	N16237G51	S1443A.....44	NRT3554
AC-5100-225	M1211KCR.....41	N16237R.....51	S1443R.....44	NRT4554
AC-51015-125	M1211KR.....41	N16237W51	S1472A.....43	NRT6554
AC-51015-1125	M1212KA.....39	N16237W-24V....51	S1472GB44	NRT7554
AC-51015-12525	M1212KBA.....39	N16237WW51	S1472P44	NRT10554
AC-51015-150 ...25	M1212KBC.....39	N1702051	S1472R.....43	NRT12054
AC-51015-175 ...25	M1212KBCA39	N1703051	S1478R.....43	NRT15054
AC-51015-225	M1212KBCB39	N17103S51	S1479R.....44	NRT20054
AC-51015-225 ...25	M1212KBCR39	N1711052	S2402CRTR.....40	NRT40054
AC-51015-250 ...25	M1212KBR39	N1712052	S2402RTR.....40	NSB10054
AC-51015-275 ...25	M1212KC39	N1713052	S2412ATR.....40	NSB12054
AC-51015-325	M1212KCA.....39	N1715052	S2412CATR40	NSB14054
AC-51015-325 ...25	M1212KCB.....39	N1721052	S2451P.....44	NSB16054
AC-5102-225	M1212KCG39	N1722052	S2480CTR.....40	NSB20054
AC-5102-2525	M1212KCR39	N1723052	SI1408.....45	NSL30254
B1343C.....44	M1212KR39	N17230DS52	SI1409.....45	NSL30354
B3922C.....43	M1212SS39	N1725052	SI1445A.....45	NSL30454
B3906CTR.....40	M1239A.....42	N17310RS52	SI1445R.....45	NSL30554
B3980CTR.....40	M1239C.....42	N17320RS52	SI470A.....45	NSL30654
EFFC96001.....34	M1239R.....42	N17330RS52	SI470R.....45	NSL30854
EFFC96002.....34	M1255A.....41	N1810053	SK-5003-1025	NSL31054
FATO10.....28	M1255GB44	N18120T53	SK-5003-2025	NSL31354
FATO15.....28	M1255P44	N1815053	TJ2329K.....45	NT8418BC56
FATO20.....28	M1255R41	N18180T53	TS-1004B.....48	NT8418ID.....56
FATO25.....28	M1256A.....41	N1820053	TS-1004W48	NT8418ID-347...56
FATO30.....28	M1256GBC44	N18810W53	TS-1008B.....48	NT8418IDD56
FATO40.....28	M1256R41	N18830W53	TS-1008W48	NT8436ID.....56
FATO528	M12572A42	N18850W53	TS-1011B.....48	NWP01.....54
FATO728	M12572R42	N19113CW55	TS-1011W48	NWP02.....54
FKAT0128	M1257A41	N19113WW55	TS-1014B.....48	NWP04.....54
FKM0228	M1257GB41	N19116CW55	TS-1014W48	NWP06.....54
FKMA03.....28	M1257R41	N19116WW55	TS-1108B.....48	NWP06HV54
FKSM0128	M1259A42	N2010053	TS-1108W48	NWP09.....54
FM1028	M1259GBC44	N2015053	TS-1114B.....48	NWP11.....54
FM1528	M1259R42	N2020053	TS-1114W48	NWP11HV54
FM2028	M1260KBA.....39	N44000WW55	TS-1121B.....48	TSB-500K.....48
FM2528	M1260KBC.....39	N46000TW.....55	TS-1121W48	TSB-600H48
FM3028	M1260KBCA39	N64000WW55	TS-1132B.....48	TSM-202048
FM528	M1260KBCR.....39	N66000TW55	TS-1132W48	TSM-240148
FM728	M1260KBR.....39	N74050KW49	NBR20CW56	TSS-101048
FMX2028	M1260SS39	N74050W-50W....49	NBR20WW56	TSS-101448
FMX3028	M1261A.....42	N74050WW-50M...49	NBR30CW56	TSS-111048
FMX4028	M1261BGP42	N74110RGB-50M...49	NBR30WW56	TSS-111448
FMX5028	M1261R.....42	N74110W49	NBR40CW56	
FMX6028	M1268KBA.....39	N74110WW49	NBR40WW56	
FMX7028	M1268KBC.....39	N75050KRGB49	NBS10CW.....56	
FMX8028	M1268KBR.....39	N75050RGB-50M...49	NBS10WW56	
FSM1028	M1272R42	N75050W-1849	NCP0454	
FSM1528	M1290A.....42	N75050W-2449	NCP0554	
FSM2028	M1290GB44	N75050W-3649	NCP0954	
FSM2528	M1290R.....42	N75050W-4849	NCP1154	
FSM3028	M1293R.....45	N75050W-50M49	NGU1016CW55	
FSM528	M1661A.....40	N75050W-5M ..49	NGU1016WW ..55	
FSM728	M1661C.....40	N7505149	NMR16CW55	
GSFR004L34	M1661R.....40	BI1910C45	NMR16WW55	
GSFR004R34	M1671A.....40	BI19110C45	NLPV-20-12.....50	
GSFR005L34	M1671C.....40	M11239R45	NPAR16CW55	
GSFR005R34	M1671R.....40	M11238A45	NPAR16WW55	
GSFR008L34	M1681A.....40	M11238R45	NPAR20CW56	
GSFR008R34	M1681C.....40	M11253A45	NPAR20WW56	
GSFR012-2.....34	M1681R.....40	M11253R45	NPAR30CW56	
GSFR012-3.....34	M15630FP50	M11255A45	NPAR30WW56	
GSFR01434	N15630MP50	M11255R45	NPAR38CW56	
GSFR124B34	N15630RGB-20...50	R1510A42	NPAR38WW56	
GSFR124C34	N15630RGB-39...50	R1510R42	NPL2X240CW....56	
GSV001L34	N15630W-1250	R1515A43	NPL2X240WW ..56	



NORTECH
INNOVATIVE PRODUCTS



INDUSTRIAL LED LIGHTING SOLUTIONS

Interior & exterior LED lighting products: strip lighting, rope lighting, Viking modules and bars, flood lights, wall packs, mega wattage flood lighting, and warehouse lighting.

LED WARNING AND VEHICLE SAFETY PRODUCTS

Beacons, directional lights, indicator arrows and warning sticks, mini light bars and full size light bars, back-up alarms, rearview cameras, road and safety flares, LED work lights, conspicuity tape and reflectors, LED strip and rope lighting, Viking modules and bars.

3330 RIDGEWAY DR, UNIT 6
MISSISSAUGA, ON, CANADA

TOLL FREE: (800) 387-3180 | Phone: (905) 569-1669 | Fax: (905) 606-2479

WWW.NORTECHINNOVATIVEPRODUCTS.COM