













































INDUSTRIAL CASTERS (TOP PLATE MODELS)					
	HK/HKR SERIES up to 400 lbs. various top plates	pg 2		LP/LPR SERIES up to 250 lbs. 2-5/8" x 3-3/4" top plate	pg 3
	BW/BWR SERIES up to 1,000 lbs. 4" x 4-1/2" top plate	pg 6		GH/GHR SERIES up to 1,650 lbs. 4-15/16" x 5-5/16" top plate	pg 9
	HD/HDR SERIES up to 1,200 lbs. 4-1/2" x 6-1/4" top plate	pg 12		LH/LHR SERIES up to 1,500 lbs. 4-1/2" x 6-1/4" top plate	pg 13
	FS/FSR SERIES up to 2,000 lbs. 4-1/2" x 6-1/4" top plate	pg 16		LS/LSR SERIES up to 3,500 lbs. 4-1/2" x 6-1/4" top plate	pg 17
	SX/SXR SERIES up to 4,600 lbs. 5-1/4" x 7-1/4" top plate	pg 19		KP/KPR SERIES up to 10,000 lbs. 6-1/4" x 7-1/2" top plate	pg 20
	TWLE/TWLER SERIES up to 3,400 lbs. 4-1/2" x 6-1/4" top plate	pg 22		TWIH/TWIHR SERIES up to 25,000 lbs. 8-1/2" x 8-1/2" top plate	pg 23
	GP/GPR SERIES up to 600 lbs. 3-3/8" x 4-1/8" top plate	pg 4		LD/LDR SERIES up to 1,500 lbs. 4" x 4-1/2" top plate	pg 10
	LE/LER SERIES up to 2,000 lbs. 4-1/2" x 6-1/4" top plate	pg 14		HX/HXR SERIES up to 3,000 lbs. 5-1/4" x 7-1/4" top plate	pg 18
	IH/IHR SERIES up to 17,000 lbs. 8-1/2" x 8-1/2" top plate	pg 21			

INDUSTRIAL CASTERS (BOLT HOLE AND STEM MODELS)					
	LB SERIES up to 230 lbs. 1/2" bolt hole	pg 24		BH SERIES up to 500 lbs. 12.2mm (or 1/2") bolt hole	pg 25
				RT/RTR SERIES up to 700 lbs. various stems	pg 27

STAINLESS STEEL CASTERS					
	SSLP/SSLPR SERIES up to 250 lbs. 2-5/8" x 3-3/4" top plate	pg 30		SSLB SERIES up to 230 lbs. 1/2" bolt hole	pg 31
	SSB SERIES up to 500 lbs. 12.2mm (or 1/2") bolt hole	pg 33		SS/SSR SERIES up to 1,000 lbs. 4" x 4-1/2" top plate	pg 34
	SSLD/SSLDR SERIES up to 1,500 lbs. 4" x 4-1/2" top plate	pg 38		SSHD/SSHDR SERIES up to 1,200 lbs. 4-1/2" x 6-1/4" top plate	pg 40
	SSLS/SSLSR SERIES up to 3,500 lbs. 4-1/2" x 6-1/4" top plate	pg 42		STAINLESS STEEL FLOOR LOCKS	pg 50
				STAINLESS STEEL WHEELS	pg 59

SPECIALTY CASTERS, LIGHT DUTY/FURNITURE CASTERS & ACCESSORIES					
	PNEUMATIC CASTERS up to 4,600 lbs. various top plates	pg 43		SCAFFOLD CASTERS up to 850 lbs. 1-3/8" x 4" stem c/w drift pin hole	pg 43
	DOOR/LADDER & GATE CASTERS	pg 44		BALL TRANSFERS	pg 45
	FC SERIES up to 80 lbs. various mounting types	pg 46		AL SERIES up to 150 lbs. various mounting types	pg 47
	TWN SERIES up to 75 lbs. various mounting types	pg 48		CBC SERIES up to 75 lbs. various mounting types	pg 48
	FLOOR LOCKS	pg 50-51		TRUCK LOCKS	pg 51
				SWIVEL MECHANISMS	pg 44
				SKATE WHEELS	pg 45
				TVAL SERIES up to 180 lbs. various mounting types	pg 47
				MISC. CASTERS	pg 49
				RUBBER BUMPERS	pg 52

WHEELS					
PHENOLIC (BAL SERIES)	pg 53	LAMINATED (LAM SERIES)	pg 54	HI-TEMP (HT SERIES)	pg 54
HI-TEMP (HTM SERIES)	pg 55	CAST STEEL (BST SERIES)	pg 56	V-GROOVE (VG SERIES)	pg 56
DUCTILE IRON (DU SERIES)	pg 57	V-GROOVE DUCTILE (VGD SERIES)	pg 58	FLANGED (FLD SERIES)	pg 59
MACHINED STEEL (MS SERIES)	pg 59	STAINLESS STEEL (SSMS SERIES)	pg 59	URETHANE (UN SERIES)	pg 60
URETHANE/NYLON (UNY SERIES)	pg 60	URETHANE/CAST (UC SERIES)	pg 61	URETHANE/ALUM (UBA SERIES)	pg 62
MEGABEST (MBA SERIES)	pg 62	ELASTOMER, SOLID (ES SERIES)	pg 63	ELASTIGLIDE (EG SERIES)	pg 63
URETHANE/DUCTILE (UDU SERIES)	pg 64	RUBBER (MR SERIES)	pg 65	GREY RUBBER (EL SERIES)	pg 65
RUBBER MOLDON (RMC SERIES)	pg 66	GREY RUBBER (AL-BB SERIES)	pg 67	RUBBER (RTC SERIES)	pg 67
RUBBER (WMT SERIES)	pg 67	POLYOLEFIN (NL SERIES)	pg 68	WHITE POLYOLEFIN (WNL SERIES)	pg 68
NYLON (NY SERIES)	pg 69	PNEUMATIC WHEELS (PN SERIES)	pg 70	SEMI-PNEUMATICS (SO SERIES)	pg 70
ANTI-STATIC WHEELS (EAS SERIES)	pg 71	PALLET WHEELS (PAL SERIES)	pg 71	CONVEYOR WHEELS (CW SERIES)	pg 71

REPLACEMENT PARTS					
BEARINGS	pg 72-74	TOP HATS	pg 73	WASHERS	pg 74
VULCA SEALS	pg 74	HEAD SEALS	pg 74	SPANNER BUSHINGS	pg 75
AXLE KITS	pg 76	TOP PLATES	pg 77-80		

HK/HKR "HUSKY" SERIES CASTERS

(formerly 100/130 Series)



400 lbs. Maximum Capacity

Top Plate: Various (see below) Mounting Holes: Various (see below)



HK-4150-EL-RB

This husky riveted caster features hardened balls in an extra wide, deep dish single race to provide long life at a reasonable price. Bright zinc plating provides an attractive appearance and added protection for this precision caster. With top plate sizes to match long time industry standards and a wide range of wheel options, this is the ideal light caster for many applications.



HKR-3125-NL

Wheel Diam.	OH	Swiv. Rad.
2"	2-1/2"	1-9/16"
2-1/2"	3-1/4"	2-3/16"
3"	3-13/16"	2-3/16"
4"	5"	3-13/16"

Wheel Size	Top Plate Dimensions		Bolthole Spacing		Bolt Size
	Swivel	Rigid	Swivel	Rigid	
2"	1-7/8" X 2-5/8"	1-7/8" X 2-5/8"	15/16" X 2-1/8"	15/16" X 2-1/8"	1/4"
2-1/2"	2-3/4" X 3-15/16"	2-1/4" X 4-1/2"	1-3/4" X 3"	1-1/16" X 3-3/8"	5/16"
3"	3-1/8" X 4-1/8"	2-1/2" X 4-15/16"	2-3/8" X 3-3/8"	1-3/16" X 4"	5/16"
4"	4" X 5"	3-1/8" X 6-1/4"	3" X 4"	1-3/4" X 5"	3/8"

Swivel Model Number	Rigid Model Number	Tread Width	Wheel Type	Capacity (lbs.)	Bearing Type	Weight (Approx)	
						Swivel	Rigid
2" Diameter Wheels							
HK-2-BST	HKR-2-BST	1"	Cast Steel	125	Plain	1.0	1.0
HK-2-UN	HKR-2-UN	7/8"	Star-Tech Urethane	120	Plain	1.0	1.0
HK-2-MR	HKR-2-MR	7/8"	Multi-Purpose Rubber	120	Plain	1.0	1.0
HK-2-NL	HKR-2-NL	3/4"	Ny-Lite	100	Plain	1.0	1.0
HK-2-WNL	HKR-2-WNL	3/4"	White Poly-Olefin	100	Plain	1.0	1.0
2-1/2" Diameter Wheels							
HK-25-BST	HKR-25-BST	1-1/8"	Cast Steel	225	Plain	2.0	1.5
HK-25-MR	HKR-25-MR	1-1/8"	Multi-Purpose Rubber	150	Plain	1.5	1.0
HK-25-NL	HKR-25-NL	1-1/8"	Ny-Lite	225	Plain	1.5	1.0
HK-25-NY	HKR-25-NY	1-1/8"	White Nylon	225	Plain	1.5	1.0
3" Diameter Wheels							
HK-3125-BAL	HKR-3125-BAL	1-1/4"	Phenolic	300	Plain	1.5	1.5
HK-3125-BST	HKR-3125-BST	1-1/4"	Cast Steel	300	Plain	2.5	2.5
HK-3125C-BST-RB	HKR-3125C-BST-RB	1-1/4"	Cast Steel (Crowned)	300	Roller	3.0	3.0
HK-3125-UN-BB	HKR-3125-UN-BB	1-1/4"	Star-Tech Urethane	250	Ball Bearing	1.5	1.5
HK-3125-MR	HKR-3125-MR	1-1/4"	Multi-Purpose Rubber	210	Plain	1.5	1.5
HK-3125-EL-BB	HKR-3125-EL-BB	1-1/4"	Eliminator Grey Rubber	200	Ball Bearing	1.5	1.5
HK-3125-NL	HKR-3125-NL	1-1/4"	Ny-Lite	275	Plain	1.5	1.5
HK-3125-WNL	HKR-3125-WNL	1-1/4"	White Poly-Olefin	275	Plain	1.5	1.5
HK-3150-BAL-RB	HKR-3150-BAL-RB	1-1/2"	Phenolic	300	Roller	2.0	2.0
HK-3150-BST-RB	HKR-3150-BST-RB	1-1/2"	Cast Steel	300	Roller	3.5	3.5
CONSULT FACTORY	HKR-3150-VG-RB	1-1/2"	Cast Steel (V-Groove)	300	Roller	3.0	3.0
HK-3150-UC-RB	HKR-3150-UC-RB	1-1/2"	Urethane on Cast	300	Roller	3.0	3.0
HK-3150C-ES-HRB	HKR-3150C-ES-HRB	1-1/2"	Solid Elastomer (Crowned)	300	HD Roller	2.0	2.0
HK-3150-NY-RB	HKR-3150-NY-RB	1-1/2"	White Nylon	300	Roller	2.0	2.0
HK-3150-EAS-PBB	HKR-3150-EAS-PBB	1-1/2"	Anti-Static Elastomer	300	Precision Ball	2.0	2.0
HK-080-HTM-HL	HKR-080-HTM-HL	35mm	Hi-Temp Monolithic	220	Hi-Lex	1.5	1.5
4" Diameter Wheels							
HK-4150-BAL-RB	HKR-4150-BAL-RB	1-1/2"	Phenolic	400	Roller	3.0	3.0
HK-4150-HT-RB	HKR-4150-HT-RB	1-1/2"	Hi-Temp Phenolic	400	Roller	3.0	3.0
HK-4150-BST	HKR-4150-BST	1-1/2"	Cast Steel	400	Plain	5.0	5.0
HK-4150-BST-RB	HKR-4150-BST-RB	1-1/2"	Cast Steel	400	Roller	5.0	5.0
CONSULT FACTORY	HKR-4150-VG-RB	1-1/2"	Cast Steel (V-Groove)	400	Roller	5.0	5.0
HK-4150-UN-RB	HKR-4150-UN-RB	1-1/2"	Star-Tech Urethane	400	Roller	3.0	3.0
HK-4150-UC-RB	HKR-4150-UC-RB	1-1/2"	Urethane on Cast	400	Roller	4.0	4.0
HK-4150C-ES-HRB	HKR-4150C-ES-HRB	1-1/2"	Solid Elastomer (Crowned)	400	HD Roller	3.0	3.0
HK-4150-MR-RB	HKR-4150-MR-RB	1-1/2"	Multi-Purpose Rubber	400	Roller	3.5	3.5
HK-4150-EL-RB	HKR-4150-EL-RB	1-1/2"	Eliminator Grey Rubber	350	Roller	3.0	3.0
HK-4150-RMC-RB	HKR-4150-RMC-RB	1-1/2"	Rubber Moldon (H90)	400	Roller	4.5	4.5
HK-4150-NL-RB	HKR-4150-NL-RB	1-1/2"	Ny-Lite	400	Roller	3.0	3.0
HK-4150-NY-RB	HKR-4150-NY-RB	1-1/2"	White Nylon	400	Roller	3.0	3.0
HK-4150-EAS-PBB	HKR-4150-EAS-PBB	1-1/2"	Anti-Static Elastomer	400	Precision Ball	3.0	3.0

Options: (1) For Side Pedal Brake on swivels only. Add code 'BR' to model number (eg. HK/BR-4150-UN-RB)
 (2) Delrin Bearing. Substitute 'DEL' for 'RB' or 'BB' in Model Number (eg. HK-3150-NY-DEL)

250 lbs. Maximum Capacity

Top Plate: 2-5/8" x 3-3/4" Mounting Holes: 1-3/4" x 2-7/8" Slotted to 1-3/4" x 3" BHS 5/16" Hole Clearance

ALSO AVAILABLE IN STAINLESS STEEL (SEE PAGE 30)

This double ball race caster is extremely versatile in many applications where light loads and ease of movement are required. Hardened balls and bright zinc plating assure long life and dependability. Industry standard top plate, large wheel selection and standard dust cover make this an excellent light duty, general use caster.



LP/BR-5125-UN-BB

Wheel Diam.	OH	Swiv. Rad.
3"	4"	3-1/8"
4"	5"	3-1/4"
5"	6"	4"

Swivel Model Number	Rigid Model Number	Tread Width	Wheel Type	Capacity (lbs.)	Bearing Type	Weight (Approx)	
						Swivel	Rigid
3" Diameter Wheels							
LP-3125-BAL	LPR-3125-BAL	1-1/4"	Phenolic	250	Plain	2.0	1.5
LP-3125-BST	LPR-3125-BST	1-1/4"	Cast Steel	250	Plain	3.0	2.5
LP-3125C-BST-RB	LPR-3125C-BST-RB	1-1/4"	Cast Steel (Crowned)	250	Roller	3.5	3.0
LP-3125-UN-BB	LPR-3125-UN-BB	1-1/4"	Star-Tech Urethane	250	Ball Bearing	2.0	1.5
LP-3125-MR	LPR-3125-MR	1-1/4"	Multi-Purpose Rubber	210	Plain	2.0	1.5
LP-3125-EL-BB	LPR-3125-EL-BB	1-1/4"	Eliminator Grey Rubber	200	Ball Bearing	2.0	1.5
LP-3125-NL	LPR-3125-NL	1-1/4"	Ny-Lite	250	Plain	2.0	1.5
LP-3125-WNL	LPR-3125-WNL	1-1/4"	White Poly-Olefin	250	Plain	2.0	1.5
LP-3150-BAL-RB	LPR-3150-BAL-RB	1-1/2"	Phenolic	250	Roller	2.5	2.0
LP-3150-BST-RB	LPR-3150-BST-RB	1-1/2"	Cast Steel	250	Roller	4.0	3.5
CONSULT FACTORY	LPR-3150-VG-RB	1-1/2"	Cast Steel (V-Groove)	250	Roller	3.5	3.0
LP-3150-UC-RB	LPR-3150-UC-RB	1-1/2"	Urethane on Cast	250	Roller	3.5	3.0
LP-3150C-ES-HRB	LPR-3150C-ES-HRB	1-1/2"	Solid Elastomer (Crowned)	250	HD Roller	2.5	2.0
LP-3150-NY-RB	LPR-3150-NY-RB	1-1/2"	White Nylon	250	Roller	2.5	2.0
LP-3150-EAS-PBB	LPR-3150-EAS-PBB	1-1/2"	Anti-Static Elastomer	250	Precision Ball	2.5	2.0
LP-080-HTM-HL	LPR-080-HTM-HL	35mm	Hi-Temp Monolithic	220	Hi-Lex	2.0	1.5
4" Diameter Wheels							
LP-4125-BAL	LPR-4125-BAL	1-1/4"	Phenolic	250	Plain	2.5	2.0
LP-4125-BST	LPR-4125-BST	1-1/4"	Cast Steel	250	Plain	3.5	3.0
LP-4125-UN-BB	LPR-4125-UN-BB	1-1/4"	Star-Tech Urethane	250	Ball Bearing	2.5	2.0
LP-4125-EL-BB	LPR-4125-EL-BB	1-1/4"	Eliminator Grey Rubber	220	Ball Bearing	2.5	2.0
LP-4125-NL	LPR-4125-NL	1-1/4"	Ny-Lite	250	Plain	2.0	1.5
LP-4125-WNL	LPR-4125-WNL	1-1/4"	White Poly-Olefin	250	Plain	2.0	1.5
LP-4138-MR	LPR-4138-MR	1-3/8"	Multi-Purpose Rubber	250	Plain	3.0	2.5
LP-4150-BAL-RB	LPR-4150-BAL-RB	1-1/2"	Phenolic	250	Roller	2.5	2.0
LP-4150-HT-RB	LPR-4150-HT-RB	1-1/2"	Hi-Temp Phenolic	250	Roller	2.5	2.0
LP-4150-BST	LPR-4150-BST	1-1/2"	Cast Steel	250	Plain	4.5	4.0
LP-4150-BST-RB	LPR-4150-BST-RB	1-1/2"	Cast Steel	250	Roller	4.5	4.0
CONSULT FACTORY	LPR-4150-VG-RB	1-1/2"	Cast Steel (V-Groove)	250	Roller	4.5	4.0
LP-4150-UN-RB	LPR-4150-UN-RB	1-1/2"	Star-Tech Urethane	250	Roller	2.5	2.0
LP-4150-UC-RB	LPR-4150-UC-RB	1-1/2"	Urethane on Cast	250	Roller	3.5	3.0
LP-4150C-ES-HRB	LPR-4150C-ES-HRB	1-1/2"	Solid Elastomer (Crowned)	250	HD Roller	2.5	2.0
LP-4150-MR-RB	LPR-4150-MR-RB	1-1/2"	Multi-Purpose Rubber	250	Roller	3.0	2.5
LP-4150-EL-RB	LPR-4150-EL-RB	1-1/2"	Eliminator Grey Rubber	250	Roller	2.5	2.0
LP-4150-RMC-RB	LPR-4150-RMC-RB	1-1/2"	Rubber Moldon (H90)	250	Roller	4.0	3.5
LP-4150-NL-RB	LPR-4150-NL-RB	1-1/2"	Ny-Lite	250	Roller	2.5	2.0
LP-4150-NY-RB	LPR-4150-NY-RB	1-1/2"	White Nylon	250	Roller	2.5	2.0
LP-4150-EAS-PBB	LPR-4150-EAS-PBB	1-1/2"	Anti-Static Elastomer	250	Precision Ball	2.5	2.0
LP-100-HTM-HL	LPR-100-HTM-HL	35mm	Hi-Temp Monolithic	250	Hi-Lex	2.5	2.0
5" Diameter Wheels							
LP-5125-BAL	LPR-5125-BAL	1-1/4"	Phenolic	250	Plain	2.5	2.0
LP-5125-UN-BB	LPR-5125-UN-BB	1-1/4"	Star-Tech Urethane	250	Ball Bearing	2.5	2.0
LP-5125-EL-BB	LPR-5125-EL-BB	1-1/4"	Eliminator Grey Rubber	250	Ball Bearing	2.5	2.0
LP-5125-NL	LPR-5125-NL	1-1/4"	Ny-Lite	250	Plain	2.0	1.5
LP-5125-WNL	LPR-5125-WNL	1-1/4"	White Poly-Olefin	250	Plain	2.0	1.5
LP-5138-MR	LPR-5138-MR	1-3/8"	Multi-Purpose Rubber	250	Plain	3.0	2.5
LP-5150-BAL-RB	LPR-5150-BAL-RB	1-1/2"	Phenolic	250	Roller	3.0	2.5
LP-5150-BST-RB	LPR-5150-BST-RB	1-1/2"	Cast Steel	250	Roller	4.5	4.0
LP-5150-UN-RB	LPR-5150-UN-RB	1-1/2"	Star-Tech Urethane	250	Roller	2.5	2.0
LP-5150-UC-RB	LPR-5150-UC-RB	1-1/2"	Urethane on Cast	250	Roller	4.5	4.0
LP-5150C-ES-HRB	LPR-5150C-ES-HRB	1-1/2"	Solid Elastomer (Crowned)	250	HD Roller	3.0	2.5
LP-5150-MR-RB	LPR-5150-MR-RB	1-1/2"	Multi-Purpose Rubber	250	Roller	3.5	3.0
LP-5150-EL-RB	LPR-5150-EL-RB	1-1/2"	Eliminator Grey Rubber	250	Roller	2.5	2.0
LP-5150-RMC-RB	LPR-5150-RMC-RB	1-1/2"	Rubber Moldon (H90)	250	Roller	4.5	4.0
LP-5150-NL-RB	LPR-5150-NL-RB	1-1/2"	Ny-Lite	250	Roller	2.5	2.0
LP-5150-NY-RB	LPR-5150-NY-RB	1-1/2"	White Nylon	250	Roller	3.0	2.5
LP-5150-EAS-PBB	LPR-5150-EAS-PBB	1-1/2"	Anti-Static Elastomer	250	Precision Ball	3.0	2.5

Options: (1) For Side Pedal Brake on swivels only. Add code 'BR' to model number (eg. LP/BR-5150-UC-RB)
 (2) Delrin Bearing. Substitute 'DEL' for 'RB' or 'BB' in Model Number (eg. LPR-3150-NY-DEL)

GP/GPR "GENERAL PURPOSE" SERIES CASTERS (formerly GN/GR Series)



600 lbs. Maximum Capacity

Top Plate: 3-3/8" x 4-1/8" Mounting Holes: 2-1/8" x 2-7/8" Slotted to 2-5/8" x 3-3/8" BHS 5/16" Hole Clearance

ALSO AVAILABLE IN STAINLESS STEEL (SEE PAGE 32)



GP-4150-EL-RB



GP/TLB-3150C-ES-HRB



GPR-4150-NY-RB

This medium duty caster is truly a beautiful product. Top plate size matches European standards. Swivels feature precision formed double ball raceways and standard head seals. The optional "Total Lock Brake" locks both the wheel and swivel with one press of the pedal. Simply kick to release. Rigids feature extreme forming for added strength. For medium duty applications nothing beats this caster.

NEW

Optional 4" x 4-1/2" Top Plate now available! (See below)

Wheel Diam.	OH	Swiv. Rad.
3"	4-1/16"	3"
4"	5-1/16"	3-1/2"
5"	6-1/8"	4-1/4"
6"	7-1/8"	4-3/4"

Swivel Model Number	Rigid Model Number	Tread Width	Wheel Type	Capacity (lbs.)	Bearing Type	Weight (Approx)	
						Swivel	Rigid
3" Diameter Wheels							
GP-3125-BAL	GPR-3125-BAL	1-1/4"	Phenolic	300	Plain	2.0	1.5
GP-3125-BST	GPR-3125-BST	1-1/4"	Cast Steel	300	Plain	3.0	2.5
GP-3125C-BST-RB	GPR-3125C-BST-RB	1-1/4"	Cast Steel (Crowned)	300	Roller	3.5	3.0
GP-3125-UN-BB	GPR-3125-UN-BB	1-1/4"	Star-Tech Urethane	250	Ball Bearing	2.0	1.5
GP-3125-MR	GPR-3125-MR	1-1/4"	Multi-Purpose Rubber	210	Plain	2.0	1.5
GP-3125-EL-BB	GPR-3125-EL-BB	1-1/4"	Eliminator Grey Rubber	200	Ball Bearing	2.0	1.5
GP-3125-NL	GPR-3125-NL	1-1/4"	Ny-Lite	275	Plain	2.0	1.5
GP-3125-WNL	GPR-3125-WNL	1-1/4"	White Poly-Olefin	275	Plain	2.0	1.5
GP-3150-BAL-RB	GPR-3150-BAL-RB	1-1/2"	Phenolic	300	Roller	2.5	2.0
GP-3150-BST-RB	GPR-3150-BST-RB	1-1/2"	Cast Steel	300	Roller	4.0	3.5
CONSULT FACTORY	GPR-3150-VG-RB	1-1/2"	Cast Steel (V-Groove)	300	Roller	3.5	3.0
GP-3150-UC-RB	GPR-3150-UC-RB	1-1/2"	Urethane on Cast	300	Roller	3.5	3.0
GP-3150C-ES-HRB	GPR-3150C-ES-HRB	1-1/2"	Solid Elastomer (Crowned)	300	HD Roller	2.5	2.0
GP-3150-NY-RB	GPR-3150-NY-RB	1-1/2"	White Nylon	300	Roller	2.5	2.0
GP-3150-EAS-PBB	GPR-3150-EAS-PBB	1-1/2"	Anti-Static Elastomer	300	Precision Ball	2.5	2.0
GP-080-HTM-HL	GPR-080-HTM-HL	35mm	Hi-Temp Monolithic	220	Hi-Lex	2.0	1.5
4" Diameter Wheels							
GP-4125-BAL	GPR-4125-BAL	1-1/4"	Phenolic	300	Plain	2.5	2.0
GP-4125-BST	GPR-4125-BST	1-1/4"	Cast Steel	400	Plain	3.5	3.0
GP-4125-UN-BB	GPR-4125-UN-BB	1-1/4"	Star-Tech Urethane	250	Ball Bearing	2.5	2.0
GP-4125-EL-BB	GPR-4125-EL-BB	1-1/4"	Eliminator Grey Rubber	220	Ball Bearing	2.5	2.0
GP-4125-NL	GPR-4125-NL	1-1/4"	Ny-Lite	300	Plain	2.0	1.5
GP-4125-WNL	GPR-4125-WNL	1-1/4"	White Poly-Olefin	300	Plain	2.0	1.5
GP-4138-MR	GPR-4138-MR	1-3/8"	Multi-Purpose Rubber	300	Plain	3.0	2.5
GP-4150-BAL-RB	GPR-4150-BAL-RB	1-1/2"	Phenolic	400	Roller	2.5	2.0
GP-4150-HT-RB	GPR-4150-HT-RB	1-1/2"	Hi-Temp Phenolic	400	Roller	2.5	2.0
GP-4150-BST	GPR-4150-BST	1-1/2"	Cast Steel	400	Plain	4.5	4.0
GP-4150-BST-RB	GPR-4150-BST-RB	1-1/2"	Cast Steel	400	Roller	4.5	4.0
CONSULT FACTORY	GPR-4150-VG-RB	1-1/2"	Cast Steel (V-Groove)	400	Roller	4.5	4.0
GP-4150-UN-RB	GPR-4150-UN-RB	1-1/2"	Star-Tech Urethane	400	Roller	2.5	2.0
GP-4150-UC-RB	GPR-4150-UC-RB	1-1/2"	Urethane on Cast	400	Roller	3.5	3.0
GP-4150C-ES-HRB	GPR-4150C-ES-HRB	1-1/2"	Solid Elastomer (Crowned)	400	HD Roller	2.5	2.0
GP-4150-MR-RB	GPR-4150-MR-RB	1-1/2"	Multi-Purpose Rubber	400	Roller	3.0	2.5
GP-4150-EL-RB	GPR-4150-EL-RB	1-1/2"	Eliminator Grey Rubber	350	Roller	2.5	2.0
GP-4150-RMC-RB	GPR-4150-RMC-RB	1-1/2"	Rubber Moldon (H90)	400	Roller	4.0	3.5
GP-4150-NL-RB	GPR-4150-NL-RB	1-1/2"	Ny-Lite	400	Roller	2.5	2.0
GP-4150-NY-RB	GPR-4150-NY-RB	1-1/2"	White Nylon	400	Roller	2.5	2.0
GP-4150-EAS-PBB	GPR-4150-EAS-PBB	1-1/2"	Anti-Static Elastomer	400	Precision Ball	2.5	2.0
GP-100-HTM-HL	GPR-100-HTM-HL	35mm	Hi-Temp Monolithic	275	Hi-Lex	2.5	2.0

Swivel Model Number	Rigid Model Number	Tread Width	Wheel Type	Capacity (lbs.)	Bearing Type	Weight (Approx)	
						Swivel	Rigid
5" Diameter Wheels							
GP-5150-BAL-RB	GPR-5150-BAL-RB	1-1/2"	Phenolic	450	Roller	3.0	2.5
GP-5150-BST-RB	GPR-5150-BST-RB	1-1/2"	Cast Steel	450	Roller	4.5	4.0
GP-5150-UN-RB	GPR-5150-UN-RB	1-1/2"	Star-Tech Urethane	450	Roller	2.5	2.0
GP-5150-UC-RB	GPR-5150-UC-RB	1-1/2"	Urethane on Cast	450	Roller	4.5	4.0
GP-5150C-ES-HRB	GPR-5150C-ES-HRB	1-1/2"	Solid Elastomer (Crowned)	450	HD Roller	3.0	2.5
GP-5150-MR-RB	GPR-5150-MR-RB	1-1/2"	Multi-Purpose Rubber	450	Roller	3.5	3.0
GP-5150-EL-RB	GPR-5150-EL-RB	1-1/2"	Eliminator Grey Rubber	400	Roller	2.5	2.0
GP-5150-RMC-RB	GPR-5150-RMC-RB	1-1/2"	Rubber Moldon (H90)	450	Roller	4.5	4.0
GP-5150-NL-RB	GPR-5150-NL-RB	1-1/2"	Ny-Lite	450	Roller	2.5	2.0
GP-5150-NY-RB	GPR-5150-NY-RB	1-1/2"	White Nylon	450	Roller	3.0	2.5
GP-5150-EAS-PBB	GPR-5150-EAS-PBB	1-1/2"	Anti-Static Elastomer	450	Precision Ball	3.0	2.5
GP-125-HTM-HL	GPR-125-HTM-HL	40mm	Hi-Temp Monolithic	330	Hi-Lex	3.0	2.5
6" Diameter Wheels							
GP-6150-BAL-RB	GPR-6150-BAL-RB	1-1/2"	Phenolic	600	Roller	4.0	3.0
GP-6150-UN-RB	GPR-6150-UN-RB	1-1/2"	Star-Tech Urethane	600	Roller	3.5	2.5
GP-6150-UC-RB	GPR-6150-UC-RB	1-1/2"	Urethane on Cast	600	Roller	5.5	4.5
GP-6150-MR-RB	GPR-6150-MR-RB	1-1/2"	Multi-Purpose Rubber	550	Roller	4.0	3.0
GP-6150-EL-RB	GPR-6150-EL-RB	1-1/2"	Eliminator Grey Rubber	500	Roller	3.5	2.5
GP-6150-RMC-RB	GPR-6150-RMC-RB	1-1/2"	Rubber Moldon (H90)	600	Roller	5.5	4.5
GP-6150-NL-RB	GPR-6150-NL-RB	1-1/2"	Ny-Lite	600	Roller	3.0	2.0
GP-6150-NY-RB	GPR-6150-NY-RB	1-1/2"	White Nylon	600	Roller	3.5	2.5

Options: (1) Total Lock Brake available on swivels only. Add code 'TLB' to model number (eg. GP/TLB-5150-EL-RB)
 (2) Optional 4" x 4-1/2" top plate available. Add code 'STP' to model number. (eg. GP/STP-6150-BAL-RB)
 (3) Delrin Bearing. Substitute 'DEL' for 'RB' or 'BB' in Model Number (eg. GP-3150-BAL-DEL)

TYPES OF BRAKES

Bestway offers a variety of brake styles with our casters. Each type offers it's own advantages over other types as described below. Our experienced sales staff can assist you in selecting the proper brake type for your specific application. Not all brake types are available with every caster series or wheel type. Consult the options list following each series listing in this catalogue for the brake types offered with that series.

Side Pedal Brake (BR):

This pedal brake is mounted on the side of the caster by way of the axle. Pushing the pedal causes the brake to activate against the side of the wheel preventing the wheel from turning. This is the most economical brake type available.



BW/BR-5150-BAL-RB

Total Lock Brake (TLB):

This pedal brake is mounted on the trailing edge of swivel casters only. Depressing the pedal causes the brake to activate against the wheel face, stopping it from turning. At the same time, the swivel lock mechanism activates against the raceway of the caster preventing the caster from swiveling. These brakes may increase the swivel radius on some casters.



GP/TLB-3150C-ES-HRB

T-Handle Brake (TBR):

This simple, yet effective brake consists of a metal "T" handle threaded into a hole in the side of the caster leg. Turning the handle causes it to activate against the side of the wheel preventing it from turning. This is especially effective on heavier casters where a cam style side pedal brake may not provide sufficient locking pressure.



HX/TBR-6300-DU-RB

Poly-Cam Brake (PCB):

This highly effective brake is ideal for heavier casters where maximum braking power is required. A poly-cam handle mounted on the caster is used to activate a brake plunger firmly against the face of the wheel preventing it from turning. These brakes may increase the swivel radius on some casters.



TWLE/PCB-5200-UBA-PBB

BW/BWR "BESTWAY" SERIES CASTERS (formerly 3100/3300 and 7100/7300 Series)



1,000 lbs. Maximum Capacity

Top Plate: 4" x 4-1/2" Mounting Holes: 2-5/8" x 3-5/8" Slotted to 3" x 3" BHS 3/8" Hole Clearance

ALSO AVAILABLE IN STAINLESS STEEL (SEE PAGE 34)



BW/TLB-6200-BAL-RB



BW-6200-PN-RB



BW/BR-5150-BAL-RB



BWR/BR-4200C-UC-RB

Our signature "Bestway" Series is simply the best caster available in the 600 to 1000 lb. capacity range. Top quality North American construction puts the imports to shame. This quiet caster is designed for easy swivelling and to take the abuse of rough, continuous service. Our superior 5/8" nut & bolt kingpin construction with precision double ball raceways prove much more durable than riveted models. Heavy 1/4" material is used throughout for maximum strength and longevity. These casters are zinc plated for lasting wear and feature a grease fitting in the swivel head for easy maintenance. A wide variety of standard options and wheel types make this a truly versatile caster and because we manufacture them here in North America we can offer quick delivery, full customization and competitive pricing. These top quality casters find extensive use in industrial plants, warehouses, institutions, department stores and anywhere that requires smooth mobility beneath a heavy load.

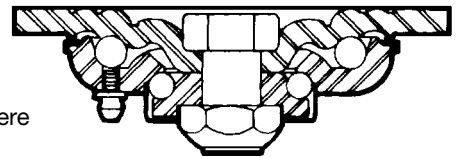

Cross-section illustrates the design of the generously proportioned upper and lower ball races, which ride on 5/16" and 1/4" diameter hardened ball bearings respectively.

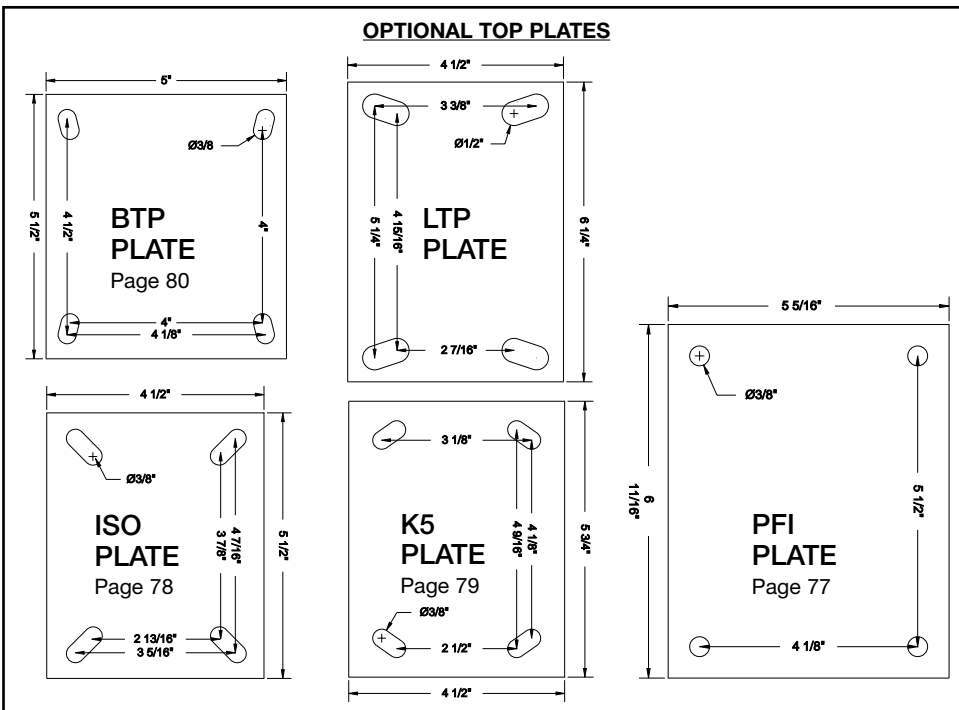

STANDARD TOP PLATE

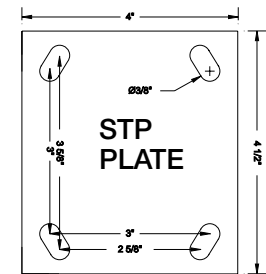

Wheel Diam.	OH	Swiv. Rad.
3"	4-3/8"	2-3/4"
3-1/4"*	4-1/2"	2-13/16"
4"	5-5/8"	3-13/16"
5"	6-1/2"	4-7/16"
6"	7-1/2"	4-9/16"
8"	9-1/2"	5-7/8"

Swivel Model Number	Rigid Model Number	Tread Width	Wheel Type	Capacity (lbs.)	Bearing Type	Weight (Approx) Swivel	Weight (Approx) Rigid
3" Diameter Wheels							
BW-3150-BAL-RB	BWR-3150-BAL-RB	1-1/2"	Phenolic	500	Roller	4.5	3.5
BW-3150-BST-RB	BWR-3150-BST-RB	1-1/2"	Cast Steel	500	Roller	6.0	5.0
CONSULT FACTORY	BWR-3150-VG-RB	1-1/2"	Cast Steel (V-Groove)	350	Roller	5.5	4.5
BW-3150-UC-RB	BWR-3150-UC-RB	1-1/2"	Urethane on Cast	400	Roller	5.5	4.5
BW-3150C-ES-HRB	BWR-3150C-ES-HRB	1-1/2"	Solid Elastomer (Crowned)	350	HD Roller	4.5	3.5
BW-3150-RMC-RB	BWR-3150-RMC-RB	1-1/2"	Rubber Moldon (H90)	300	Roller	5.5	4.5
BW-3150-NY-RB	BWR-3150-NY-RB	1-1/2"	White Nylon	500	Roller	4.5	3.5
BW-3200-BAL-RB*	BWR-3200-BAL-RB*	2"	Phenolic	700	Roller	4.5	3.5
BW-3200-BST-RB	BWR-3200-BST-RB	2"	Cast Steel	700	Roller	7.0	6.0
BW-3200-UC-RB	BWR-3200-UC-RB	2"	Urethane on Cast	540	Roller	6.0	5.0
BW-3200-NY-RB	BWR-3200-NY-RB	2"	White Nylon	700	Roller	4.5	3.5

Swivel Model Number	Rigid Model Number	Tread Width	Wheel Type	Capacity (lbs.)	Bearing Type	Weight (Approx)	
						Swivel	Rigid
4" Diameter Wheels							
BW-4150-BAL-RB	BWR-4150-BAL-RB	1-1/2"	Phenolic	600	Roller	4.5	3.5
BW-4150-HT-RB	BWR-4150-HT-RB	1-1/2"	Hi-Temp Phenolic	400	Roller	4.5	3.5
BW-4150-BST	BWR-4150-BST	1-1/2"	Cast Steel	600	Plain	6.5	5.5
BW-4150-BST-RB	BWR-4150-BST-RB	1-1/2"	Cast Steel	600	Roller	6.5	5.5
CONSULT FACTORY	BWR-4150-VG-RB	1-1/2"	Cast Steel (V-Groove)	500	Roller	6.5	5.5
BW-4150-UN-RB	BWR-4150-UN-RB	1-1/2"	Star-Tech Urethane	440	Roller	4.5	3.5
BW-4150-UC-RB	BWR-4150-UC-RB	1-1/2"	Urethane on Cast	600	Roller	5.5	4.5
BW-4150C-ES-HRB	BWR-4150C-ES-HRB	1-1/2"	Solid Elastomer (Crowned)	400	HD Roller	4.5	3.5
BW-4150-MR-RB	BWR-4150-MR-RB	1-1/2"	Multi-Purpose Rubber	400	Roller	5.0	4.0
BW-4150-EL-RB	BWR-4150-EL-RB	1-1/2"	Eliminator Grey Rubber	350	Roller	4.5	3.5
BW-4150-RMC-RB	BWR-4150-RMC-RB	1-1/2"	Rubber Moldon (H90)	500	Roller	6.0	5.0
BW-4150-NL-RB	BWR-4150-NL-RB	1-1/2"	Ny-Lite	420	Roller	4.5	3.5
BW-4150-NY-RB	BWR-4150-NY-RB	1-1/2"	White Nylon	600	Roller	4.5	3.5
BW-4200-BAL-RB	BWR-4200-BAL-RB	2"	Phenolic	800	Roller	5.0	4.0
BW-4200-LAM-RB	BWR-4200-LAM-RB	2"	Laminated Phenolic	900	Roller	5.0	4.0
BW-4200-HT-RB	BWR-4200-HT-RB	2"	Hi-Temp Phenolic	500	Roller	5.0	4.0
BW-4200-BST-RB	BWR-4200-BST-RB	2"	Cast Steel	800	Roller	7.0	6.0
CONSULT FACTORY	BWR-4200-VG-RB	2"	Cast Steel (V-Groove)	800	Roller	8.0	7.0
BW-4200C-DU-RB	BWR-4200C-DU-RB	2"	Ductile Iron (Crowned)	900	Roller	8.5	7.5
CONSULT FACTORY	BWR-4200-VGD-RB	2"	Ductile Iron (V-Groove)	900	Roller	8.0	7.0
CONSULT FACTORY	BWR-4200-FLD-RB	2"	Ductile Iron (Flanged)	900	Roller	10.0	9.0
BW-4200-UN-RB	BWR-4200-UN-RB	2"	Star-Tech Urethane	600	Roller	4.5	3.5
BW-4200-UC-RB	BWR-4200-UC-RB	2"	Urethane on Cast	700	Roller	6.5	5.5
BW-4200C-UC-RB	BWR-4200C-UC-RB	2"	Urethane on Cast (Crowned)	800	Roller	6.5	5.5
BW-4200C-UBA-PBB	BWR-4200C-UBA-PBB	2"	Urethane on Alum. (Crowned)	900	Precision Ball	5.5	4.5
BW-4200C-MBA-PBB	BWR-4200C-MBA-PBB	2"	Megabest (Crowned)	300	Precision Ball	5.5	4.5
BW-4200C-ES-HRB	BWR-4200C-ES-HRB	2"	Solid Elastomer (Crowned)	800	HD Roller	5.0	4.0
BW-4200C-ES-PBB	BWR-4200C-ES-PBB	2"	Solid Elastomer (Crowned)	800	Precision Ball	5.0	4.0
BW-4200-MR-RB	BWR-4200-MR-RB	2"	Multi-Purpose Rubber	450	Roller	5.5	4.5
BW-4200-EL-RB	BWR-4200-EL-RB	2"	Eliminator Grey Rubber	600	Roller	4.5	3.5
BW-4200-RMC-RB	BWR-4200-RMC-RB	2"	Rubber Moldon (H90)	700	Roller	6.5	5.5
BW-4200-NL-RB	BWR-4200-NL-RB	2"	Ny-Lite	500	Roller	4.5	3.5
BW-4200-NY-RB	BWR-4200-NY-RB	2"	White Nylon	800	Roller	5.0	4.0
5" Diameter Wheels							
BW-5150-BAL-RB	BWR-5150-BAL-RB	1-1/2"	Phenolic	600	Roller	5.5	4.0
BW-5150-BST-RB	BWR-5150-BST-RB	1-1/2"	Cast Steel	650	Roller	7.0	5.5
BW-5150-UN-RB	BWR-5150-UN-RB	1-1/2"	Star-Tech Urethane	500	Roller	5.0	3.5
BW-5150-UC-RB	BWR-5150-UC-RB	1-1/2"	Urethane on Cast	650	Roller	7.0	5.5
BW-5150C-ES-HRB	BWR-5150C-ES-HRB	1-1/2"	Solid Elastomer (Crowned)	500	HD Roller	5.5	4.0
BW-5150-MR-RB	BWR-5150-MR-RB	1-1/2"	Multi-Purpose Rubber	450	Roller	6.0	4.5
BW-5150-EL-RB	BWR-5150-EL-RB	1-1/2"	Eliminator Grey Rubber	400	Roller	5.0	3.5
BW-5150-RMC-RB	BWR-5150-RMC-RB	1-1/2"	Rubber Moldon (H90)	600	Roller	7.0	5.5
BW-5150-NL-RB	BWR-5150-NL-RB	1-1/2"	Ny-Lite	550	Roller	5.0	3.5
BW-5150-NY-RB	BWR-5150-NY-RB	1-1/2"	White Nylon	600	Roller	5.5	4.0
BW-5200-BAL-RB	BWR-5200-BAL-RB	2"	Phenolic	900	Roller	6.0	4.5
BW-5200-LAM-RB	BWR-5200-LAM-RB	2"	Laminated Phenolic	900	Roller	6.0	4.5
BW-5200-HT-RB	BWR-5200-HT-RB	2"	Hi-Temp Phenolic	750	Roller	6.0	4.5
BW-5200-BST-RB	BWR-5200-BST-RB	2"	Cast Steel	825	Roller	9.0	7.5
CONSULT FACTORY	BWR-5200-VG-RB	2"	Cast Steel (V-Groove)	800	Roller	10.0	8.5
BW-5200C-DU-RB	BWR-5200C-DU-RB	2"	Ductile Iron (Crowned)	900	Roller	9.0	7.5
CONSULT FACTORY	BWR-5200-VGD-RB	2"	Ductile Iron (V-Groove)	900	Roller	10.0	8.5
CONSULT FACTORY	BWR-5200-FLD-RB	2"	Ductile Iron (Flanged)	900	Roller	13.0	11.5
BW-5200-UN-RB	BWR-5200-UN-RB	2"	Star-Tech Urethane	750	Roller	5.5	4.0
BW-5200-UC-RB	BWR-5200-UC-RB	2"	Urethane on Cast	900	Roller	7.5	6.0
BW-5200C-UC-RB	BWR-5200C-UC-RB	2"	Urethane on Cast (Crowned)	900	Roller	7.5	6.0
BW-5200C-UBA-PBB	BWR-5200C-UBA-PBB	2"	Urethane on Alum. (Crowned)	900	Precision Ball	6.0	4.5
BW-5200C-MBA-PBB	BWR-5200C-MBA-PBB	2"	Megabest (Crowned)	300	Precision Ball	6.0	4.5
BW-5200C-ES-HRB	BWR-5200C-ES-HRB	2"	Solid Elastomer (Crowned)	900	HD Roller	5.5	4.0
BW-5200C-ES-PBB	BWR-5200C-ES-PBB	2"	Solid Elastomer (Crowned)	900	Precision Ball	5.5	4.0
BW-5200-MR-RB	BWR-5200-MR-RB	2"	Multi-Purpose Rubber	550	Roller	6.0	4.5
BW-5200-EL-RB	BWR-5200-EL-RB	2"	Eliminator Grey Rubber	700	Roller	5.5	4.0
BW-5200-RMC-RB	BWR-5200-RMC-RB	2"	Rubber Moldon (H90)	800	Roller	7.5	6.0
BW-5200-NL-RB	BWR-5200-NL-RB	2"	Ny-Lite	650	Roller	5.5	4.0
BW-5200-NY-RB	BWR-5200-NY-RB	2"	White Nylon	900	Roller	5.5	4.0

Swivel Model Number	Rigid Model Number	Tread Width	Wheel Type	Capacity (lbs.)	Bearing Type	Weight (Approx)	
						Swivel	Rigid
6" Diameter Wheels							
BW-6150-BAL-RB	BWR-6150-BAL-RB	1-1/2"	Phenolic	700	Roller	6.0	4.5
BW-6150-UN-RB	BWR-6150-UN-RB	1-1/2"	Star-Tech Urethane	600	Roller	5.5	4.0
BW-6150-UC-RB	BWR-6150-UC-RB	1-1/2"	Urethane on Cast	700	Roller	7.5	6.0
BW-6150-MR-RB	BWR-6150-MR-RB	1-1/2"	Multi-Purpose Rubber	550	Roller	6.0	4.5
BW-6150-EL-RB	BWR-6150-EL-RB	1-1/2"	Eliminator Grey Rubber	500	Roller	5.5	4.0
BW-6150-RMC-RB	BWR-6150-RMC-RB	1-1/2"	Rubber Moldon (H90)	620	Roller	7.5	6.0
BW-6150-NL-RB	BWR-6150-NL-RB	1-1/2"	Ny-Lite	600	Roller	5.0	3.5
BW-6150-NY-RB	BWR-6150-NY-RB	1-1/2"	White Nylon	700	Roller	5.5	4.0
BW-6200-BAL-RB	BWR-6200-BAL-RB	2"	Phenolic	900	Roller	7.0	5.5
BW-6200-LAM-RB	BWR-6200-LAM-RB	2"	Laminated Phenolic	900	Roller	7.0	5.5
BW-6200-HT-RB	BWR-6200-HT-RB	2"	Hi-Temp Phenolic	900	Roller	7.0	5.5
BW-6200-BST-RB	BWR-6200-BST-RB	2"	Cast Steel	900	Roller	9.5	8.0
CONSULT FACTORY	BWR-6200-VG-RB	2"	Cast Steel (V-Groove)	900	Roller	12.0	10.5
BW-6200C-DU-RB	BWR-6200C-DU-RB	2"	Ductile Iron (Crowned)	900	Roller	11.5	10.0
CONSULT FACTORY	BWR-6200-VGD-RB	2"	Ductile Iron (V-Groove)	900	Roller	12.0	10.5
CONSULT FACTORY	BWR-6200-FLD-RB	2"	Ductile Iron (Flanged)	900	Roller	14.5	13.0
BW-6200-UN-RB	BWR-6200-UN-RB	2"	Star-Tech Urethane	900	Roller	6.0	4.5
BW-6200-UC-RB	BWR-6200-UC-RB	2"	Urethane on Cast	900	Roller	8.5	7.0
BW-6200C-UC-RB	BWR-6200C-UC-RB	2"	Urethane on Cast (Crowned)	900	Roller	8.5	7.0
BW-6200C-UBA-PBB	BWR-6200C-UBA-PBB	2"	Urethane on Alum. (Crowned)	900	Precision Ball	7.0	5.5
BW-6200C-MBA-PBB	BWR-6200C-MBA-PBB	2"	Megabest (Crowned)	400	Precision Ball	7.0	5.5
BW-6200-ES-HRB	BWR-6200-ES-HRB	2"	Solid Elastomer	900	HD Roller	7.0	5.5
BW-6200-ES-PBB	BWR-6200-ES-PBB	2"	Solid Elastomer	900	Precision Ball	7.0	5.5
BW-6200C-ES-HRB	BWR-6200C-ES-HRB	2"	Solid Elastomer (Crowned)	900	HD Roller	6.5	5.0
BW-6200C-ES-PBB	BWR-6200C-ES-PBB	2"	Solid Elastomer (Crowned)	900	Precision Ball	6.5	5.0
BW-6200C-EG-PBB	BWR-6200C-EG-PBB	2"	Elastiglide (Crowned)	900	Precision Ball	7.0	5.5
BW-6200-MR-RB	BWR-6200-MR-RB	2"	Multi-Purpose Rubber	650	Roller	7.0	5.5
BW-6200-EL-RB	BWR-6200-EL-RB	2"	Eliminator Grey Rubber	900	Roller	6.0	4.5
BW-6200-RMC-RB	BWR-6200-RMC-RB	2"	Rubber Moldon (H90)	900	Roller	8.0	6.5
BW-6200C-RTC-RB	BWR-6200C-RTC-RB	2"	Grey Donut Rubber	420	Roller	8.5	7.0
BW-6200-NL-RB	BWR-6200-NL-RB	2"	Ny-Lite	800	Roller	5.5	4.0
BW-6200-NY-RB	BWR-6200-NY-RB	2"	White Nylon	900	Roller	6.0	4.5
BW-6200-PN-RB	BWR-6200-PN-RB	2"	Full Pneumatic	300	Roller	6.0	4.5
8" Diameter Wheels							
BW-8200-BAL-RB	BWR-8200-BAL-RB	2"	Phenolic	1000	Roller	8.0	7.0
BW-8200-LAM-RB	BWR-8200-LAM-RB	2"	Laminated Phenolic	1000	Roller	8.0	7.0
BW-8200-HT-RB	BWR-8200-HT-RB	2"	Hi-Temp Phenolic	1000	Roller	8.0	7.0
BW-8200-BST-RB	BWR-8200-BST-RB	2"	Cast Steel	1000	Roller	13.0	12.0
BW-8200C-DU-RB	BWR-8200C-DU-RB	2"	Ductile Iron (Crowned)	1000	Roller	16.0	15.0
CONSULT FACTORY	BWR-8200-VGD-RB	2"	Ductile Iron (V-Groove)	1000	Roller	15.5	14.5
CONSULT FACTORY	BWR-8200-FLD-RB	2"	Ductile Iron (Flanged)	1000	Roller	25.5	24.5
BW-8200-UN-RB	BWR-8200-UN-RB	2"	Star-Tech Urethane	1000	Roller	6.5	5.5
BW-8200-UC-RB	BWR-8200-UC-RB	2"	Urethane on Cast	1000	Roller	11.0	10.0
BW-8200C-UC-RB	BWR-8200C-UC-RB	2"	Urethane on Cast (Crowned)	1000	Roller	10.5	9.5
BW-8200C-UBA-PBB	BWR-8200C-UBA-PBB	2"	Urethane on Alum. (Crowned)	1000	Precision Ball	9.0	8.0
BW-8200C-MBA-PBB	BWR-8200C-MBA-PBB	2"	Megabest (Crowned)	500	Precision Ball	9.5	8.5
BW-8200-ES-HRB	BWR-8200-ES-HRB	2"	Solid Elastomer	1000	HD Roller	7.5	6.5
BW-8200-ES-PBB	BWR-8200-ES-PBB	2"	Solid Elastomer	1000	Precision Ball	7.5	6.5
BW-8200C-ES-HRB	BWR-8200C-ES-HRB	2"	Solid Elastomer (Crowned)	1000	HD Roller	9.0	8.0
BW-8200C-ES-PBB	BWR-8200C-ES-PBB	2"	Solid Elastomer (Crowned)	1000	Precision Ball	9.0	8.0
BW-8200C-EG-PBB	BWR-8200C-EG-PBB	2"	Elastiglide (Crowned)	1000	Precision Ball	9.5	8.5
BW-8200-MR-RB	BWR-8200-MR-RB	2"	Multi-Purpose Rubber	700	Roller	8.5	7.5
BW-8200-EL-RB	BWR-8200-EL-RB	2"	Eliminator Grey Rubber	900	Roller	6.5	5.5
BW-8200-RMC-RB	BWR-8200-RMC-RB	2"	Rubber Moldon (H90)	1000	Roller	10.5	9.5
BW-8200C-RTC-RB	BWR-8200C-RTC-RB	2"	Grey Donut Rubber	500	Roller	10.5	9.5
BW-8200-NL-RB	BWR-8200-NL-RB	2"	Ny-Lite	1000	Roller	6.0	5.0
BW-8200-NY-RB	BWR-8200-NY-RB	2"	White Nylon	1000	Roller	7.0	6.0

- Options:**
- (1) Pedal Brake available on swivels and rigids. Add code 'BR' to model number (eg. BW/**BR**-8200-BST-RB)
 - (2) Total Lock Brake available on 4" x 4-1/2" plate swivels only. Add code 'TLB' to model number (eg. BW/**TLB**-8200-BAL-RB)
Not available on 3" models.
 - (3) Four Position Swivel Lock. Add code '4SL' to model number (eg. BW/**4SL**-5200-EL-RB). Special order with ISO, K5 and PFI Plates.
 - (4) Optional Top Plates available. Add code LTP, BTP, ISO, K5 or PFI to model number. (eg. BWR/**LTP**-5200-BAL-RB)
 - (5) Head Seals available on swivels only. Add code 'HS' to model number. (eg. BW/**HS**-4150-NL-RB)
 - (6) Delrin Bearing. Substitute 'DEL' for 'RB' in Model Number (eg. BW-4200-MR-**DEL**)
 - (7) Heavy Duty Roller Bearing. Substitute 'HRB' for 'RB' in Model Number (eg. BW-6200C-DU-**HRB**)
 - (8) Flanged Ball Bearing. Substitute 'BB' for 'RB' in Model Number (eg. BW-8200-UC-**BB**)
 - (9) Flanged Brass Bearing. Substitute 'BF' for 'RB' in Model Number (eg. BW-6200-HT-**BF**)

1,650 lbs. Maximum Capacity

Top Plate: 4-5/16" x 5-5/16" Mounting Holes: 2-15/16" x 4-1/8" Slotted to 3-3/8" x 4-1/8" BHS 7/16" Hole Clearance

Double ball race and extreme stiffening on fork sides make this one of the strongest and most dependable casters available for 2" face wheels. Attractive

GOLD coloured dichromate zinc plating and head seals are standard. Top plate size matches common European models. Heavy duty "Total Lock Brake" which locks both the wheel and the swivel with one push of a pedal is available on 5", 6" and 8" models. Excellent results have been achieved in the garbage container and sandblasting industries where rough usage is the norm.

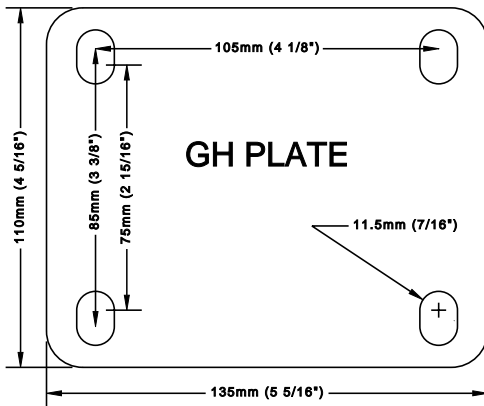

(See Page 78 for full scale drawing)



GHR-8200C-DU-RB

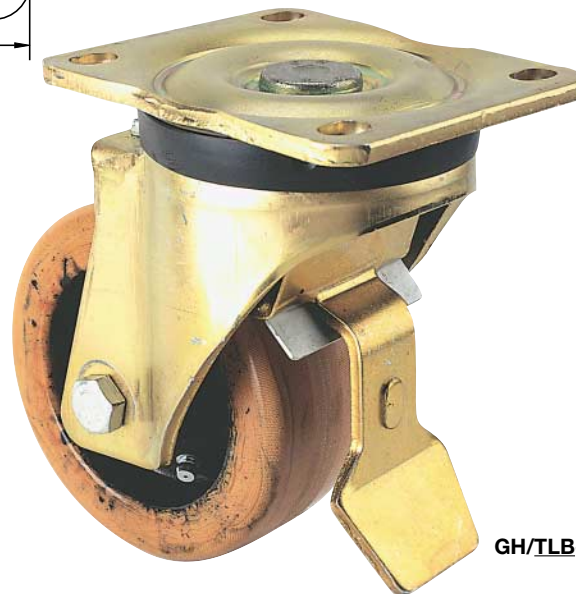

GH/TLB-5200-LAM-RB

Wheel Diam.	OH	Swiv. Rad.
4"	5-7/8"	4-3/16"
5"	6-15/16"	4-11/16"
6"	7-15/16"	5-5/16"
8"	9-7/8"	6-9/16"

Swivel Model Number	Rigid Model Number	Tread Width	Wheel Type	Capacity (lbs.)	Bearing Type	Weight (Approx) Swivel	Weight (Approx) Rigid
4" Diameter Wheels							
GH-4200-BAL-RB	GHR-4200-BAL-RB	2"	Phenolic	800	Roller	6.5	4.5
GH-4200-LAM-RB	GHR-4200-LAM-RB	2"	Laminated Phenolic	1200	Roller	6.5	4.5
GH-4200C-DU-RB	GHR-4200C-DU-RB	2"	Ductile Iron (Crowned)	1650	Roller	10.0	8.0
GH-4200-UN-RB	GHR-4200-UN-RB	2"	Star-Tech Urethane	600	Roller	6.0	4.0
GH-4200C-ES-PBB	GHR-4200C-ES-PBB	2"	Solid Elastomer (Crowned)	800	Precision Ball	6.5	4.5
5" Diameter Wheels							
GH-5200-BAL-RB	GHR-5200-BAL-RB	2"	Phenolic	1000	Roller	7.0	5.5
GH-5200-LAM-RB	GHR-5200-LAM-RB	2"	Laminated Phenolic	1400	Roller	7.0	5.5
GH-5200C-DU-RB	GHR-5200C-DU-RB	2"	Ductile Iron (Crowned)	1650	Roller	10.0	8.5
GH-5200-UN-RB	GHR-5200-UN-RB	2"	Star-Tech Urethane	750	Roller	6.5	5.0
GH-5200C-ES-PBB	GHR-5200C-ES-PBB	2"	Solid Elastomer (Crowned)	1000	Precision Ball	6.5	5.0
6" Diameter Wheels							
GH-6200-BAL-RB	GHR-6200-BAL-RB	2"	Phenolic	1200	Roller	8.0	6.5
GH-6200-LAM-RB	GHR-6200-LAM-RB	2"	Laminated Phenolic	1500	Roller	8.0	6.5
GH-6200C-DU-RB	GHR-6200C-DU-RB	2"	Ductile Iron (Crowned)	1650	Roller	12.5	11.0
GH-6200-UN-RB	GHR-6200-UN-RB	2"	Star-Tech Urethane	900	Roller	7.0	5.5
GH-6200C-ES-PBB	GHR-6200C-ES-PBB	2"	Solid Elastomer (Crowned)	1200	Precision Ball	7.5	6.0
8" Diameter Wheels							
GH-8200-BAL-RB	GHR-8200-BAL-RB	2"	Phenolic	1400	Roller	9.5	8.5
GH-8200-LAM-RB	GHR-8200-LAM-RB	2"	Laminated Phenolic	1650	Roller	9.5	8.5
GH-8200C-DU-RB	GHR-8200C-DU-RB	2"	Ductile Iron (Crowned)	1650	Roller	17.5	16.5
GH-8200-UN-RB	GHR-8200-UN-RB	2"	Star-Tech Urethane	1000	Roller	8.0	7.0
GH-8200C-ES-PBB	GHR-8200C-ES-PBB	2"	Solid Elastomer (Crowned)	1600	Precision Ball	10.5	9.5

- Options:** (1) Total Lock Brake available on 5", 6" and 8" swivels only. Add code 'TLB' to model number (eg. GH/TLB-8200-BAL-RB)
 (2) Delrin Bearing. Substitute 'DEL' for 'RB' in Model Number (eg. GH-4200-UN-DEL)
 (3) Heavy Duty Roller Bearing. Substitute 'HRB' for 'RB' in Model Number (eg. GH-6200C-DU-HRB)
 (4) Flanged Brass Bearing. Substitute 'BF' for 'RB' in Model Number (eg. GH-6200-LAM-BF)

LD/LDR SERIES KINGBOLTLESS CASTERS



1,500 lbs. Maximum Capacity

Top Plate: 4" x 4-1/2" Mounting Holes: 2-5/8" x 3-5/8" Slotted to 3" x 3" BHS 3/8" Hole Clearance

ALSO AVAILABLE IN STAINLESS STEEL (SEE PAGE 38)



LD-6200C-DU-RB



LDR-6200C-UC-RB

This revolutionary caster uses Bestway's PATENTED Double Ball Kingboltless design to eliminate the need for rivets or kingbolts, a common cause of caster failures (see page 15 for full details about our breakthrough design). With a higher capacity than traditional kingpin designs, and engineered to withstand punishing towline and shockload applications which would destroy most ordinary casters, the LD Series is a truly exceptional product.

North American made for fast delivery and competitive pricing and are fully customizable upon request.

The LD swivel uses 3-1/2" diameter precision machined and hardened raceways incorporating over sixty 1/4" diameter ball bearings in two raceways, securely welded to a 1/4" top plate. Legs are welded inside and out. The caster is zinc plated for a lasting finish and fitted with a threaded 45° angle grease fitting for easy maintenance.

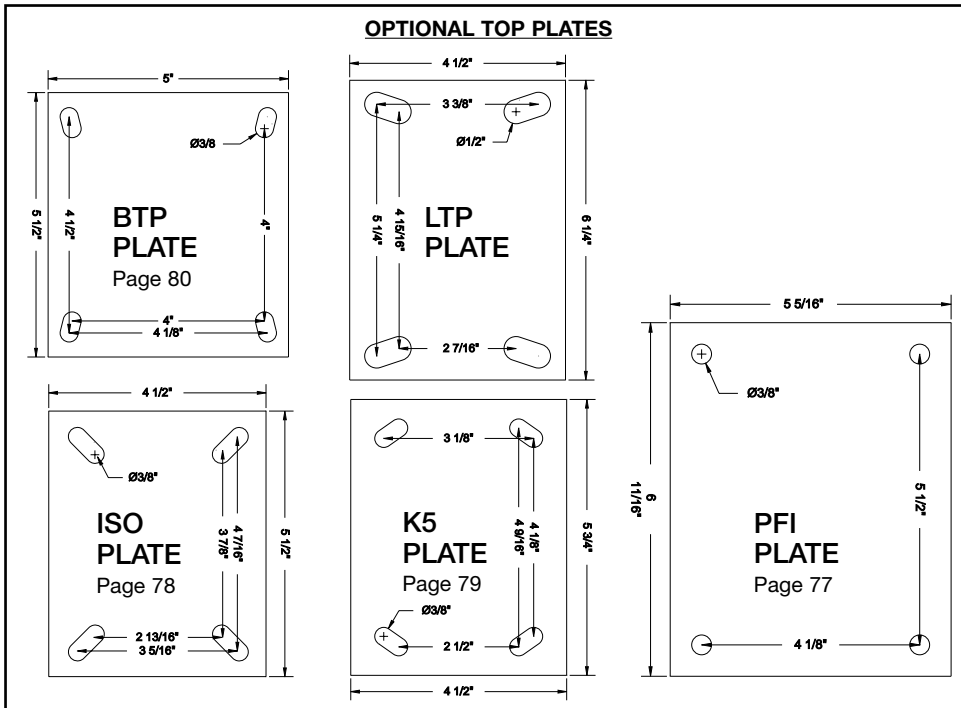

STANDARD TOP PLATE

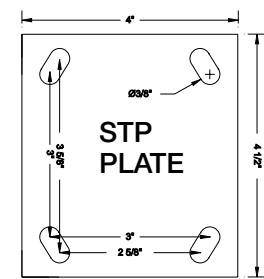

Wheel Diam.	OH	Swiv. Rad.
3"	4-1/2"	2-1/2"
3-1/4"*	4-5/8"	2-9/16"
4"	5-5/8"	2-11/16"
5"	6-1/2"	3-1/2"
6"	7-1/2"	4-1/4"
8"	9-1/2"	6-1/4"

US Patent #: 5,983,451

Canadian Patent #: 2,179,802

Swivel Model Number	Rigid Model Number	Tread Width	Wheel Type	Capacity (lbs.)	Bearing Type	Weight (Approx)	
						Swivel	Rigid
3" Diameter Wheels							
LD-3200-BST-RB	LDR-3200-BST-RB	2"	Cast Steel	700	Roller	8.0	6.0
LD-3200-UC-RB	LDR-3200-UC-RB	2"	Urethane on Cast	540	Roller	7.0	5.0
LD-3200-BAL-RB*	LDR-3200-BAL-RB*	2"	Phenolic	700	Roller	5.5	3.5
4" Diameter Wheels							
LD-4200-BAL-RB	LDR-4200-BAL-RB	2"	Phenolic	800	Roller	6.0	4.0
LD-4200-LAM-RB	LDR-4200-LAM-RB	2"	Laminated Phenolic	1200	Roller	6.0	4.0
LD-4200-HT-RB	LDR-4200-HT-RB	2"	Hi-Temp Phenolic	500	Roller	6.0	4.0
LD-4200-BST-RB	LDR-4200-BST-RB	2"	Cast Steel	800	Roller	8.0	6.0
CONSULT FACTORY	LDR-4200-VG-RB	2"	Cast Steel (V-Groove)	800	Roller	9.0	7.0
LD-4200C-DU-RB	LDR-4200C-DU-RB	2"	Ductile Iron (Crowned)	1500	Roller	9.5	7.5
CONSULT FACTORY	LDR-4200-VGD-RB	2"	Ductile Iron (V-Groove)	1500	Roller	9.0	7.0
CONSULT FACTORY	LDR-4200-FLD-RB	2"	Ductile Iron (Flanged)	1500	Roller	11.0	9.0
LD-4200-MS-RB	LDR-4200-MS-RB	2"	Machined Steel	1500	Roller	13.5	11.5
LD-4200-UN-RB	LDR-4200-UN-RB	2"	Star-Tech Urethane	600	Roller	5.5	3.5
LD-4200-UC-RB	LDR-4200-UC-RB	2"	Urethane on Cast	700	Roller	7.5	5.5
LD-4200C-UC-RB	LDR-4200C-UC-RB	2"	Urethane on Cast (Crowned)	800	Roller	7.5	5.5
LD-4200C-UBA-PBB	LDR-4200C-UBA-PBB	2"	Urethane on Alum. (Crowned)	900	Precision Ball	6.5	4.5
LD-4200C-MBA-PBB	LDR-4200C-MBA-PBB	2"	Megabest (Crowned)	300	Precision Ball	6.5	4.5
LD-4200C-ES-PBB	LDR-4200C-ES-PBB	2"	Solid Elastomer (Crowned)	800	Precision Ball	6.0	4.0
LD-4200-EL-RB	LDR-4200-EL-RB	2"	Eliminator Grey Rubber	600	Roller	5.5	3.5
LD-4200-RMC-RB	LDR-4200-RMC-RB	2"	Rubber Moldon (H90)	700	Roller	7.5	5.5

Swivel Model Number	Rigid Model Number	Tread Width	Wheel Type	Capacity (lbs.)	Bearing Type	Weight (Approx)	
						Swivel	Rigid
5" Diameter Wheels							
LD-5200-BAL-RB	LDR-5200-BAL-RB	2"	Phenolic	1000	Roller	7.0	4.5
LD-5200-LAM-RB	LDR-5200-LAM-RB	2"	Laminated Phenolic	1400	Roller	7.0	4.5
LD-5200-HT-RB	LDR-5200-HT-RB	2"	Hi-Temp Phenolic	750	Roller	7.0	4.5
LD-5200-BST-RB	LDR-5200-BST-RB	2"	Cast Steel	825	Roller	10.0	7.5
CONSULT FACTORY	LDR-5200-VG-RB	2"	Cast Steel (V-Groove)	800	Roller	11.0	8.5
LD-5200C-DU-RB	LDR-5200C-DU-RB	2"	Ductile Iron (Crowned)	1500	Roller	10.0	7.5
CONSULT FACTORY	LDR-5200-VGD-RB	2"	Ductile Iron (V-Groove)	1500	Roller	11.0	8.5
CONSULT FACTORY	LDR-5200-FLD-RB	2"	Ductile Iron (Flanged)	1500	Roller	14.0	11.5
LD-5200-MS-RB	LDR-5200-MS-RB	2"	Machined Steel	1500	Roller	19.0	16.5
LD-5200-UN-RB	LDR-5200-UN-RB	2"	Star-Tech Urethane	750	Roller	6.5	4.0
LD-5200-UC-RB	LDR-5200-UC-RB	2"	Urethane on Cast	1050	Roller	8.5	6.0
LD-5200C-UC-RB	LDR-5200C-UC-RB	2"	Urethane on Cast (Crowned)	1000	Roller	8.5	6.0
LD-5200C-UBA-PBB	LDR-5200C-UBA-PBB	2"	Urethane on Alum. (Crowned)	900	Precision Ball	7.0	4.5
LD-5200C-MBA-PBB	LDR-5200C-MBA-PBB	2"	Megabest (Crowned)	300	Precision Ball	7.0	4.5
LD-5200C-ES-PBB	LDR-5200C-ES-PBB	2"	Solid Elastomer (Crowned)	1000	Precision Ball	6.5	4.0
LD-5200-EL-RB	LDR-5200-EL-RB	2"	Eliminator Grey Rubber	700	Roller	6.5	4.0
LD-5200-RMC-RB	LDR-5200-RMC-RB	2"	Rubber Moldon (H90)	800	Roller	8.5	6.0
6" Diameter Wheels							
LD-6200-BAL-RB	LDR-6200-BAL-RB	2"	Phenolic	1200	Roller	8.0	5.5
LD-6200-LAM-RB	LDR-6200-LAM-RB	2"	Laminated Phenolic	1500	Roller	8.0	5.5
LD-6200-HT-RB	LDR-6200-HT-RB	2"	Hi-Temp Phenolic	900	Roller	8.0	5.5
LD-6200-BST-RB	LDR-6200-BST-RB	2"	Cast Steel	1000	Roller	10.5	8.0
CONSULT FACTORY	LDR-6200-VG-RB	2"	Cast Steel (V-Groove)	1000	Roller	13.0	10.5
LD-6200C-DU-RB	LDR-6200C-DU-RB	2"	Ductile Iron (Crowned)	1500	Roller	12.5	10.0
CONSULT FACTORY	LDR-6200-VGD-RB	2"	Ductile Iron (V-Groove)	1500	Roller	13.0	10.5
CONSULT FACTORY	LDR-6200-FLD-RB	2"	Ductile Iron (Flanged)	1500	Roller	15.5	13.0
LD-6200-MS-RB	LDR-6200-MS-RB	2"	Machined Steel	1500	Roller	25.0	22.5
LD-6200-UN-RB	LDR-6200-UN-RB	2"	Star-Tech Urethane	900	Roller	7.0	4.5
LD-6200-UC-RB	LDR-6200-UC-RB	2"	Urethane on Cast	1230	Roller	9.5	7.0
LD-6200C-UC-RB	LDR-6200C-UC-RB	2"	Urethane on Cast (Crowned)	1050	Roller	9.5	7.0
LD-6200C-UBA-PBB	LDR-6200C-UBA-PBB	2"	Urethane on Alum. (Crowned)	1200	Precision Ball	8.0	5.5
LD-6200C-MBA-PBB	LDR-6200C-MBA-PBB	2"	Megabest (Crowned)	400	Precision Ball	8.0	5.5
LD-6200-ES-PBB	LDR-6200-ES-PBB	2"	Solid Elastomer	1200	Precision Ball	7.5	5.0
LD-6200C-ES-PBB	LDR-6200C-ES-PBB	2"	Solid Elastomer (Crowned)	1200	Precision Ball	7.5	5.0
LD-6200C-EG-PBB	LDR-6200C-EG-PBB	2"	Elastiglide (Crowned)	1200	Precision Ball	8.0	5.5
LD-6200-EL-RB	LDR-6200-EL-RB	2"	Eliminator Grey Rubber	900	Roller	7.0	4.5
LD-6200-RMC-RB	LDR-6200-RMC-RB	2"	Rubber Moldon (H90)	900	Roller	9.0	6.5
8" Diameter Wheels							
LD-8200-BAL-RB	LDR-8200-BAL-RB	2"	Phenolic	1400	Roller	9.0	7.0
LD-8200-LAM-RB	LDR-8200-LAM-RB	2"	Laminated Phenolic	1500	Roller	9.0	7.0
LD-8200-HT-RB	LDR-8200-HT-RB	2"	Hi-Temp Phenolic	1100	Roller	9.0	7.0
LD-8200-BST-RB	LDR-8200-BST-RB	2"	Cast Steel	1200	Roller	14.0	12.0
LD-8200C-DU-RB	LDR-8200C-DU-RB	2"	Ductile Iron (Crowned)	1500	Roller	17.0	15.0
CONSULT FACTORY	LDR-8200-VGD-RB	2"	Ductile Iron (V-Groove)	1500	Roller	16.5	14.5
CONSULT FACTORY	LDR-8200-FLD-RB	2"	Ductile Iron (Flanged)	1500	Roller	26.5	24.5
LD-8200-UN-RB	LDR-8200-UN-RB	2"	Star-Tech Urethane	1000	Roller	7.5	5.5
LD-8200-UC-RB	LDR-8200-UC-RB	2"	Urethane on Cast	1500	Roller	12.0	10.0
LD-8200C-UC-RB	LDR-8200C-UC-RB	2"	Urethane on Cast (Crowned)	1250	Roller	11.5	9.5
LD-8200C-UBA-PBB	LDR-8200C-UBA-PBB	2"	Urethane on Alum. (Crowned)	1500	Precision Ball	10.0	8.0
LD-8200C-MBA-PBB	LDR-8200C-MBA-PBB	2"	Megabest (Crowned)	500	Precision Ball	10.5	8.5
LD-8200-ES-PBB	LDR-8200-ES-PBB	2"	Solid Elastomer	1500	Precision Ball	8.5	6.5
LD-8200C-ES-PBB	LDR-8200C-ES-PBB	2"	Solid Elastomer (Crowned)	1500	Precision Ball	10.0	8.0
LD-8200C-EG-PBB	LDR-8200C-EG-PBB	2"	Elastiglide (Crowned)	1500	Precision Ball	10.5	8.5
LD-8200-EL-RB	LDR-8200-EL-RB	2"	Eliminator Grey Rubber	900	Roller	7.5	5.5
LD-8200-RMC-RB	LDR-8200-RMC-RB	2"	Rubber Moldon (H90)	1000	Roller	11.5	9.5

- Options:** (1) Pedal Brake available on swivels and rigids. Add code 'BR' to model number (eg. LD/**BR**-8200-BST-RB)
(2) Four Position Swivel Lock. Add code '4SL' to model number (eg. LD/**4SL**-5200-EL-RB). Special order with ISO, K5 and PFI Plates.
(3) Optional Top Plates available. Add code LTP, BTP, ISO, K5 or PFI to model number. (eg. LDR/**LTP**-5200-BAL-RB)
(4) Head Seals available on swivels only. Add code 'HS' to model number. (eg. LD/**HS**-4200-NL-RB)
(5) Heavy Duty Roller Bearing. Substitute 'HRB' for 'RB' in Model Number (eg. LD-6200C-DU-**HRB**)
(6) Flanged Brass Bearing. Substitute 'BF' for 'RB' in Model Number (eg. LD-6200-HT-**BF**)

HD/HDR SERIES CASTERS

1,200 lbs. Maximum Capacity

Top Plate: 4-1/2" x 6-1/4" Mounting Holes: 2-7/16" x 4-15/16" Slotted to 3-3/8" x 5-1/4" BHS 1/2" Hole Clearance

ALSO AVAILABLE IN STAINLESS STEEL (SEE PAGE 40)



HD/4SL-6200-UC-RB

This is a heavier duty version of our proven "Bestway" Series casters. It's improved features include; a high-capacity 3/4" nut & bolt kingpin, larger upper and lower ball races featuring 3/8" and 5/16" diameter hardened ball bearings respectively, a larger (4-1/2" x 6-1/4") industry standard top plate, and reinforced legs on both swivels and rigids.



HD-6200-HT-RB

With attractive zinc plate finish and a grease fitting in the swivel head, this caster is ideal for those higher capacity applications. North American made for fast delivery and competitive pricing and are fully customizable upon request.

Wheel Diam.	OH	Swiv. Rad.
4"	5-5/8"	3-5/16"
5"	6-1/2"	3-3/4"
6"	7-1/2"	4-5/8"
8"	New! 9-1/2"	6-3/8"

Swivel Model Number	Rigid Model Number	Tread Width	Wheel Type	Capacity (lbs.)	Bearing Type	Weight (Approx)	
						Swivel	Rigid
4" Diameter Wheels							
HD-4200-BAL-RB	HDR-4200-BAL-RB	2"	Phenolic	800	Roller	6.5	4.5
HD-4200-LAM-RB	HDR-4200-LAM-RB	2"	Laminated Phenolic	1000	Roller	6.5	4.5
HD-4200-HT-RB	HDR-4200-HT-RB	2"	Hi-Temp Phenolic	500	Roller	6.5	4.5
HD-4200-BST-RB	HDR-4200-BST-RB	2"	Cast Steel	800	Roller	8.5	6.5
CONSULT FACTORY	HDR-4200-VG-RB	2"	Cast Steel (V-Groove)	800	Roller	9.5	7.5
HD-4200C-DU-RB	HDR-4200C-DU-RB	2"	Ductile Iron (Crowned)	1000	Roller	10.0	8.0
CONSULT FACTORY	HDR-4200-VGD-RB	2"	Ductile Iron (V-Groove)	1000	Roller	9.5	7.5
CONSULT FACTORY	HDR-4200-FLD-RB	2"	Ductile Iron (Flanged)	1000	Roller	11.5	9.5
HD-4200-UN-RB	HDR-4200-UN-RB	2"	Star-Tech Urethane	600	Roller	6.0	4.0
HD-4200-UC-RB	HDR-4200-UC-RB	2"	Urethane on Cast	700	Roller	8.0	6.0
HD-4200C-UC-RB	HDR-4200C-UC-RB	2"	Urethane on Cast (Crowned)	800	Roller	8.0	6.0
HD-4200C-ES-HRB	HDR-4200C-ES-HRB	2"	Solid Elastomer (Crowned)	800	HD Roller	6.5	4.5
HD-4200-EL-RB	HDR-4200-EL-RB	2"	Eliminator Grey Rubber	600	Roller	6.0	4.0
HD-4200-RMC-RB	HDR-4200-RMC-RB	2"	Rubber Moldon (H90)	700	Roller	8.0	6.0
HD-4200-NL-RB	HDR-4200-NL-RB	2"	Ny-Lite	500	Roller	6.0	4.0
5" Diameter Wheels							
HD-5200-BAL-RB	HDR-5200-BAL-RB	2"	Phenolic	1000	Roller	7.0	5.0
HD-5200-LAM-RB	HDR-5200-LAM-RB	2"	Laminated Phenolic	1000	Roller	7.0	5.0
HD-5200-HT-RB	HDR-5200-HT-RB	2"	Hi-Temp Phenolic	750	Roller	7.0	5.0
HD-5200-BST-RB	HDR-5200-BST-RB	2"	Cast Steel	825	Roller	10.0	8.0
CONSULT FACTORY	HDR-5200-VG-RB	2"	Cast Steel (V-Groove)	800	Roller	11.0	9.0
HD-5200C-DU-RB	HDR-5200C-DU-RB	2"	Ductile Iron (Crowned)	1000	Roller	10.0	8.0
CONSULT FACTORY	HDR-5200-VGD-RB	2"	Ductile Iron (V-Groove)	1000	Roller	11.0	9.0
CONSULT FACTORY	HDR-5200-FLD-RB	2"	Ductile Iron (Flanged)	1000	Roller	14.0	12.0
HD-5200-UN-RB	HDR-5200-UN-RB	2"	Star-Tech Urethane	750	Roller	6.5	4.5
HD-5200-UC-RB	HDR-5200-UC-RB	2"	Urethane on Cast	1000	Roller	8.5	6.5
HD-5200C-UC-RB	HDR-5200C-UC-RB	2"	Urethane on Cast (Crowned)	1000	Roller	8.5	6.5
HD-5200C-ES-HRB	HDR-5200C-ES-HRB	2"	Solid Elastomer (Crowned)	1000	HD Roller	6.5	4.5
HD-5200-EL-RB	HDR-5200-EL-RB	2"	Eliminator Grey Rubber	700	Roller	6.5	4.5
HD-5200-RMC-RB	HDR-5200-RMC-RB	2"	Rubber Moldon (H90)	800	Roller	8.5	6.5
HD-5200-NL-RB	HDR-5200-NL-RB	2"	Ny-Lite	650	Roller	6.5	4.5
6" Diameter Wheels							
HD-6200-BAL-RB	HDR-6200-BAL-RB	2"	Phenolic	1200	Roller	8.5	6.5
HD-6200-LAM-RB	HDR-6200-LAM-RB	2"	Laminated Phenolic	1200	Roller	8.5	6.5
HD-6200-HT-RB	HDR-6200-HT-RB	2"	Hi-Temp Phenolic	900	Roller	8.5	6.5
HD-6200-BST-RB	HDR-6200-BST-RB	2"	Cast Steel	1000	Roller	11.0	9.0
CONSULT FACTORY	HDR-6200-VG-RB	2"	Cast Steel (V-Groove)	1000	Roller	13.5	11.5
HD-6200C-DU-RB	HDR-6200C-DU-RB	2"	Ductile Iron (Crowned)	1200	Roller	13.0	11.0
CONSULT FACTORY	HDR-6200-VGD-RB	2"	Ductile Iron (V-Groove)	1200	Roller	13.5	11.5
CONSULT FACTORY	HDR-6200-FLD-RB	2"	Ductile Iron (Flanged)	1200	Roller	16.0	14.0
HD-6200-UN-RB	HDR-6200-UN-RB	2"	Star-Tech Urethane	900	Roller	7.5	5.5
HD-6200-UC-RB	HDR-6200-UC-RB	2"	Urethane on Cast	1200	Roller	10.0	8.0
HD-6200C-UC-RB	HDR-6200C-UC-RB	2"	Urethane on Cast (Crowned)	1050	Roller	10.0	8.0
HD-6200-ES-HRB	HDR-6200-ES-HRB	2"	Solid Elastomer	1200	HD Roller	8.0	6.0
HD-6200C-ES-HRB	HDR-6200C-ES-HRB	2"	Solid Elastomer (Crowned)	1200	HD Roller	8.0	6.0
HD-6200-EL-RB	HDR-6200-EL-RB	2"	Eliminator Grey Rubber	900	Roller	7.5	5.5
HD-6200-RMC-RB	HDR-6200-RMC-RB	2"	Rubber Moldon (H90)	900	Roller	9.5	7.5
HD-6200-NL-RB	HDR-6200-NL-RB	2"	Ny-Lite	800	Roller	7.0	5.0

Swivel Model Number	Rigid Model Number	Tread Width	Wheel Type	Capacity (lbs.)	Bearing Type	Weight (Approx)	
						Swivel	Rigid
8" Diameter Wheels							
HD-8200-BAL-RB	HDR-8200-BAL-RB	2"	Phenolic	1200	Roller	10.0	8.0
HD-8200-LAM-RB	HDR-8200-LAM-RB	2"	Laminated Phenolic	1200	Roller	10.0	8.0
HD-8200-HT-RB	HDR-8200-HT-RB	2"	Hi-Temp Phenolic	1100	Roller	10.0	8.0
HD-8200-BST-RB	HDR-8200-BST-RB	2"	Cast Steel	1200	Roller	15.0	13.0
HD-8200C-DU-RB	HDR-8200C-DU-RB	2"	Ductile Iron (Crowned)	1200	Roller	18.0	16.0
CONSULT FACTORY	HDR-8200-VGD-RB	2"	Ductile Iron (V-Groove)	1200	Roller	17.5	15.5
CONSULT FACTORY	HDR-8200-FLD-RB	2"	Ductile Iron (Flanged)	1200	Roller	27.5	25.5
HD-8200-UN-RB	HDR-8200-UN-RB	2"	Star-Tech Urethane	1000	Roller	8.5	6.5
HD-8200-UC-RB	HDR-8200-UC-RB	2"	Urethane on Cast	1200	Roller	13.0	11.0
HD-8200C-UC-RB	HDR-8200C-UC-RB	2"	Urethane on Cast (Crowned)	1200	Roller	12.5	10.5
HD-8200-ES-HRB	HDR-8200-ES-HRB	2"	Solid Elastomer	1200	HD Roller	9.5	7.5
HD-8200C-ES-HRB	HDR-8200C-ES-HRB	2"	Solid Elastomer (Crowned)	1200	HD Roller	11.0	9.0
HD-8200-EL-RB	HDR-8200-EL-RB	2"	Eliminator Grey Rubber	900	Roller	8.5	6.5
HD-8200-RMC-RB	HDR-8200-RMC-RB	2"	Rubber Moldon (H90)	1000	Roller	12.5	10.5
HD-8200-NL-RB	HDR-8200-NL-RB	2"	Ny-Lite	1000	Roller	8.0	6.0

- Options:** (1) Pedal Brake available on swivels and rigids. Add code 'BR' to model number (eg. HD/**BR**-8200-BST-RB)
 (2) Four Position Swivel Lock. Add code '4SL' to model number (eg. HD/**4SL**-5200-EL-RB)
 (3) Head Seals available on swivels only. Add code 'HS' to model number. (eg. HD/**HS**-4200-NL-RB)
 (4) Delrin Bearing. Substitute 'DEL' for 'RB' in Model Number (eg. HD-4200-MR-**DEL**)
 (5) Heavy Duty Roller Bearing. Substitute 'HRB' for 'RB' in Model Number (eg. HD-6200C-DU-**HRB**)
 (6) Flanged Brass Bearing. Substitute 'BF' for 'RB' in Model Number (eg. HD-6200-HT-**BF**)

LH/LHR SERIES CASTERS

1,500 lbs. Maximum Capacity

Top Plate: 4-1/2" x 6-1/4" Mounting Holes: 2-7/16" x 4-15/16" Slotted to 3-3/8" x 5-1/4" BHS 1/2" Hole Clearance

ALSO AVAILABLE IN STAINLESS STEEL (CONSULT FACTORY)

The LH Series is designed for those applications that call for a Light Heavy-Duty caster. This caster uses the same high-capacity 3/4" nut & bolt kingpin design as our popular HD Series, but with a heavy-duty 3/4" axle and wider leg spacing to accommodate a 2-1/2" face wheel. This high quality North American made caster is an excellent alternative for those in-between jobs.

Wheel Diam.	OH	Swiv. Rad.
6"	7-1/2"	4-5/8"
8"	10-1/8"	6-1/2"
10"	11-1/2"	7-3/4"

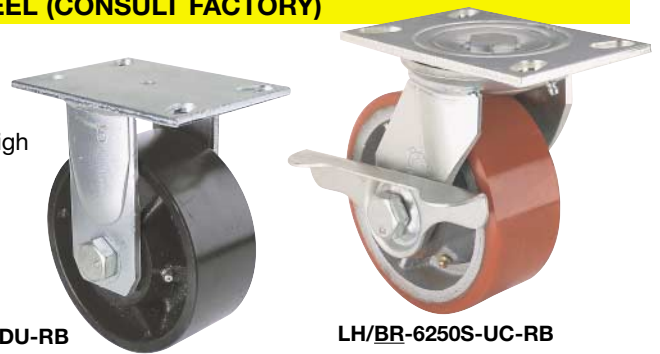

LHR-6250S-DU-RB

LH/BR-6250S-UC-RB

Swivel Model Number	Rigid Model Number	Tread Width	Wheel Type	Capacity (lbs.)	Bearing Type	Weight (Approx)	
						Swivel	Rigid
6" Diameter Wheels							
LH-6250S-BAL-RB	LHR-6250S-BAL-RB	2-1/2"	Phenolic	1500	Roller	10.0	8.5
LH-6250S-DU-RB	LHR-6250S-DU-RB	2-1/2"	Ductile Iron	1500	Roller	17.5	16.0
CONSULT FACTORY	LHR-6250S-VGD-RB	2-1/2"	Ductile Iron (V-Groove)	1500	Roller	17.0	15.5
LH-6250S-UC-RB	LHR-6250S-UC-RB	2-1/2"	Urethane on Cast	1500	Roller	14.5	13.0
LH-6250S-RMC-RB	LHR-6250S-RMC-RB	2-1/2"	Rubber Moldon (H90)	1100	Roller	12.5	11.0
8" Diameter Wheels							
LH-8250S-BAL-RB	LHR-8250S-BAL-RB	2-1/2"	Phenolic	1500	Roller	12.0	10.5
LH-8250S-DU-RB	LHR-8250S-DU-RB	2-1/2"	Ductile Iron	1500	Roller	26.0	24.5
CONSULT FACTORY	LHR-8250S-VGD-RB	2-1/2"	Ductile Iron (V-Groove)	1500	Roller	24.5	23.0
LH-8250S-UC-RB	LHR-8250S-UC-RB	2-1/2"	Urethane on Cast	1500	Roller	19.0	17.5
LH-8250S-RMC-RB	LHR-8250S-RMC-RB	2-1/2"	Rubber Moldon (H90)	1500	Roller	16.0	14.5
10" Diameter Wheels							
LH-10250S-BAL-RB	LHR-10250S-BAL-RB	2-1/2"	Phenolic	1500	Roller	13.5	12.0
LH-10250S-DU-RB	LHR-10250S-DU-RB	2-1/2"	Ductile Iron	1500	Roller	24.5	23.0
LH-10250S-UC-RB	LHR-10250S-UC-RB	2-1/2"	Urethane on Cast	1500	Roller	26.0	24.5
LH-10250SC-UBA-PBB	LHR-10250SC-UBA-PBB	2-1/2"	Urethane on Alum. (Crowned)	1500	Precision Ball	15.0	13.5
LH-10250SC-MBA-PBB	LHR-10250SC-MBA-PBB	2-1/2"	Megabest (Crowned)	1000	Precision Ball	15.0	13.5
LH-10250S-RMC-RB	LHR-10250S-RMC-RB	2-1/2"	Rubber Moldon (H90)	1500	Roller	18.5	17.0

- Options:** (1) Pedal Brake available on swivels and rigids. Add code 'BR' to model number (eg. LH/**BR**-8250S-DU-RB)
 (2) Four Position Swivel Lock. Add code '4SL' to model number (eg. LH/**4SL**-6250S-UC-RB)
 (3) Head Seals available on swivels only. Add code 'HS' to model number. (eg. LH/**HS**-10250SC-MBA-PBB)
 (4) Delrin Bearing. Substitute 'DEL' for 'RB' in Model Number (eg. LH-6250S-BAL-**DEL**)

Note: Stainless Steel versions are available. Add code 'SS' before model number. (eg. **SSLH**-10250SC-UBA-PBB)

LE/LER SERIES KINGBOLTLESS CASTERS



2,000 lbs. Maximum Capacity

Top Plate: 4-1/2" x 6-1/4" Mounting Holes: 2-7/16" x 4-15/16" Slotted to 3-3/8" x 5-1/4" BHS 1/2" Hole Clearance

ALSO AVAILABLE IN STAINLESS STEEL (SEE PAGE 41)

The LE Series uses the same PATENTED Double Ball Kingboltless design as our revolutionary LD Series (see page 15 for full details about our breakthrough design) but takes it a step further. Our LE casters feature a larger 4-1/2" diameter swivel head locked together by over fifty 5/16" ball bearings in two precision machined raceways, a larger (4-1/2" x 6-1/4") industry standard top plate and double welded, extra-strength formed steel fork legs. Together these improvements make for a performance and durability unheard of in a 2" wheel face caster. Since there is no kingpin to bend or break, this caster is ideal for towline and shockload applications. Zinc plating gives an attractive appearance and a lasting finish. Fitted with a threaded 45° angle grease fitting for easy maintenance. North American made for fast delivery and competitive pricing and are fully customizable upon request.



LE-5200-BAL-RB



LER-8200C-EG-PBB

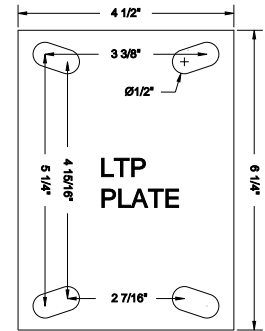

STANDARD TOP PLATE (LTP)

US Patent #: 5,983,451

Canadian Patent #: 2,179,802

Wheel Diam.	OH	Swiv. Rad.
4"	5-5/8"	3-3/8"
5"	6-1/2"	4"
6"	7-1/2"	4-3/8"
8"	New! 9-1/2"	5-11/16"

Swivel Model Number	Rigid Model Number	Tread Width	Wheel Type	Capacity (lbs.)	Bearing Type	Weight (Approx)	
						Swivel	Rigid
4" Diameter Wheels							
LE-4200-BAL-RB	LER-4200-BAL-RB	2"	Phenolic	800	Roller	9.0	5.5
LE-4200-LAM-RB	LER-4200-LAM-RB	2"	Laminated Phenolic	1200	Roller	9.0	5.5
LE-4200-HT-RB	LER-4200-HT-RB	2"	Hi-Temp Phenolic	500	Roller	9.0	5.5
LE-4200C-DU-RB	LER-4200C-DU-RB	2"	Ductile Iron (Crowned)	1750	Roller	12.5	9.0
CONSULT FACTORY	LER-4200-VGD-RB	2"	Ductile Iron (V-Groove)	1500	Roller	12.0	8.5
CONSULT FACTORY	LER-4200-FLD-RB	2"	Ductile Iron (Flanged)	1750	Roller	14.0	10.5
LE-4200-MS-RB	LER-4200-MS-RB	2"	Machined Steel	1750	Roller	16.5	13.0
LE-4200-UN-RB	LER-4200-UN-RB	2"	Star-Tech Urethane	600	Roller	8.5	5.0
LE-4200-UC-RB	LER-4200-UC-RB	2"	Urethane on Cast	700	Roller	10.5	7.0
LE-4200C-UC-RB	LER-4200C-UC-RB	2"	Urethane on Cast (Crowned)	800	Roller	10.5	7.0
LE-4200C-UBA-PBB	LER-4200C-UBA-PBB	2"	Urethane on Alum. (Crowned)	900	Precision Ball	9.5	6.0
LE-4200C-MBA-PBB	LER-4200C-MBA-PBB	2"	Megabest (Crowned)	300	Precision Ball	9.5	6.0
LE-4200C-ES-PBB	LER-4200C-ES-PBB	2"	Solid Elastomer (Crowned)	800	Precision Ball	9.0	5.5
LE-4200-EL-RB	LER-4200-EL-RB	2"	Eliminator Grey Rubber	600	Roller	8.5	5.0
5" Diameter Wheels							
LE-5200-BAL-RB	LER-5200-BAL-RB	2"	Phenolic	1000	Roller	9.5	6.0
LE-5200-LAM-RB	LER-5200-LAM-RB	2"	Laminated Phenolic	1400	Roller	9.5	6.0
LE-5200-HT-RB	LER-5200-HT-RB	2"	Hi-Temp Phenolic	750	Roller	9.5	6.0
LE-5200C-DU-RB	LER-5200C-DU-RB	2"	Ductile Iron (Crowned)	1750	Roller	12.5	9.0
CONSULT FACTORY	LER-5200-VGD-RB	2"	Ductile Iron (V-Groove)	1500	Roller	13.5	10.0
CONSULT FACTORY	LER-5200-FLD-RB	2"	Ductile Iron (Flanged)	1750	Roller	16.5	13.0
LE-5200-MS-RB	LER-5200-MS-RB	2"	Machined Steel	1750	Roller	21.5	18.0
LE-5200-UN-RB	LER-5200-UN-RB	2"	Star-Tech Urethane	750	Roller	8.5	5.0
LE-5200-UC-RB	LER-5200-UC-RB	2"	Urethane on Cast	1050	Roller	11.0	7.5
LE-5200C-UC-RB	LER-5200C-UC-RB	2"	Urethane on Cast (Crowned)	1000	Roller	11.0	7.5
LE-5200C-UBA-PBB	LER-5200C-UBA-PBB	2"	Urethane on Alum. (Crowned)	900	Precision Ball	9.5	6.0
LE-5200C-MBA-PBB	LER-5200C-MBA-PBB	2"	Megabest (Crowned)	300	Precision Ball	9.5	6.0
LE-5200C-ES-PBB	LER-5200C-ES-PBB	2"	Solid Elastomer (Crowned)	1000	Precision Ball	9.0	5.5
LE-5200-EL-RB	LER-5200-EL-RB	2"	Eliminator Grey Rubber	700	Roller	9.0	5.5

Swivel Model Number	Rigid Model Number	Tread Width	Wheel Type	Capacity (lbs.)	Bearing Type	Weight (Approx)	
						Swivel	Rigid
6" Diameter Wheels							
LE-6200-BAL-RB	LER-6200-BAL-RB	2"	Phenolic	1200	Roller	10.5	7.0
LE-6200-LAM-RB	LER-6200-LAM-RB	2"	Laminated Phenolic	1500	Roller	10.5	7.0
LE-6200-HT-RB	LER-6200-HT-RB	2"	Hi-Temp Phenolic	900	Roller	10.5	7.0
LE-6200C-DU-RB	LER-6200C-DU-RB	2"	Ductile Iron (Crowned)	1800	Roller	15.0	11.5
CONSULT FACTORY	LER-6200-VGD-RB	2"	Ductile Iron (V-Groove)	1800	Roller	15.5	12.0
CONSULT FACTORY	LER-6200-FLD-RB	2"	Ductile Iron (Flanged)	1900	Roller	18.0	14.5
LE-6200-MS-RB	LER-6200-MS-RB	2"	Machined Steel	1900	Roller	27.5	24.0
LE-6200-UN-RB	LER-6200-UN-RB	2"	Star-Tech Urethane	900	Roller	9.5	6.0
LE-6200-UC-RB	LER-6200-UC-RB	2"	Urethane on Cast	1230	Roller	12.0	8.5
LE-6200C-UC-RB	LER-6200C-UC-RB	2"	Urethane on Cast (Crowned)	1050	Roller	12.0	8.5
LE-6200C-UBA-PBB	LER-6200C-UBA-PBB	2"	Urethane on Alum. (Crowned)	1200	Precision Ball	10.5	7.0
LE-6200C-MBA-PBB	LER-6200C-MBA-PBB	2"	Megabest (Crowned)	400	Precision Ball	10.5	7.0
LE-6200C-ES-PBB	LER-6200C-ES-PBB	2"	Solid Elastomer (Crowned)	1200	Precision Ball	10.0	6.5
LE-6200C-EG-PBB	LER-6200C-EG-PBB	2"	Elastiglide (Crowned)	1200	Precision Ball	10.5	7.0
LE-6200-EL-RB	LER-6200-EL-RB	2"	Eliminator Grey Rubber	900	Roller	9.5	6.0
8" Diameter Wheels							
LE-8200-BAL-RB	LER-8200-BAL-RB	2"	Phenolic	1400	Roller	12.0	8.5
LE-8200-LAM-RB	LER-8200-LAM-RB	2"	Laminated Phenolic	1700	Roller	12.0	8.5
LE-8200-HT-RB	LER-8200-HT-RB	2"	Hi-Temp Phenolic	1100	Roller	12.0	8.5
LE-8200C-DU-RB	LER-8200C-DU-RB	2"	Ductile Iron (Crowned)	1900	Roller	20.0	16.5
CONSULT FACTORY	LER-8200-VGD-RB	2"	Ductile Iron (V-Groove)	1900	Roller	19.5	16.0
CONSULT FACTORY	LER-8200-FLD-RB	2"	Ductile Iron (Flanged)	1900	Roller	29.5	26.0
LE-8200-UN-RB	LER-8200-UN-RB	2"	Star-Tech Urethane	1000	Roller	10.5	7.0
LE-8200-UC-RB	LER-8200-UC-RB	2"	Urethane on Cast	1500	Roller	15.0	11.5
LE-8200C-UC-RB	LER-8200C-UC-RB	2"	Urethane on Cast (Crowned)	1250	Roller	14.5	11.0
LE-8200C-UBA-PBB	LER-8200C-UBA-PBB	2"	Urethane on Alum. (Crowned)	1500	Precision Ball	13.0	9.5
LE-8200C-MBA-PBB	LER-8200C-MBA-PBB	2"	Megabest (Crowned)	500	Precision Ball	13.5	10.0
LE-8200C-ES-PBB	LER-8200C-ES-PBB	2"	Solid Elastomer (Crowned)	1600	Precision Ball	13.0	9.5
LE-8200C-EG-PBB	LER-8200C-EG-PBB	2"	Elastiglide (Crowned)	1500	Precision Ball	13.5	10.0
LE-8200-EL-RB	LER-8200-EL-RB	2"	Eliminator Grey Rubber	900	Roller	10.5	7.0

- Options:** (1) Pedal Brake available on swivels and rigids. Add code 'BR' to model number (eg. LE/BR-8200C-DU-RB)
 (2) Four Position Swivel Lock. Add code '4SL' to model number (eg. LE/4SL-5200-UC-RB)
 (3) Head Seals available on swivels only. Add code 'HS' to model number. (eg. LE/HS-4200-EL-RB)
 (4) Heavy Duty Roller Bearing. Substitute 'HRB' for 'RB' in Model Number (eg. LE-6200C-DU-HRB)
 (5) Flanged Brass Bearing. Substitute 'BF' for 'RB' in Model Number (eg. LE-6200-HT-BF)

BESTWAY'S PATENTED DOUBLE BALL KINGBOLTLESS CASTERS

Bestway has revolutionized the Caster Industry with the introduction of our PATENTED Double Ball Kingboltless Casters! Traditional Caster designs feature a rivet or kingpin to hold together the raceways of a swivel caster. While this design may be fine for many applications, rough usage, shockload or towline applications can place tremendous force on the kingpin causing it to bend. Once this happens, the caster will fail to swivel properly and the raceway may open up allowing the ball bearings to escape or the kingpin may even break.

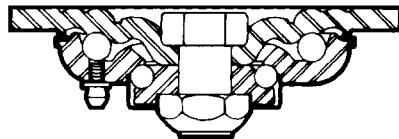

Cross-section of traditional caster designs

Bestway has overcome this problem with the invention of our revolutionary Double Ball Kingboltless Casters. These swivels feature a pair of precision-machined raceways welded directly to the mounting plate. The entire assembly is locked together by a double row of hardened ball bearings. Unlike inferior single race models, this design allows one raceway to handle the load and the second race to take the swivel action, making the caster much easier to operate. Most importantly, there is no kingpin to bend or break. The resulting caster is not only much stronger than traditional designs, but also lasts much longer under even the most extreme conditions.

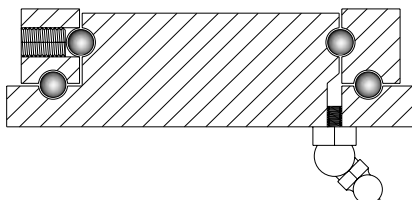

Cross-section of Patented Double Ball Kingboltless Design

US Patent #: 5,983,451

Canadian Patent #: 2,179,802

By using only Bestway PATENTED Double Ball Kingboltless Casters you can rest assured that you are dealing with the industry leader in caster design innovation. Bestway is also your guarantee of quality since all of our PATENTED Double Ball Kingboltless Casters are North American made, ensuring the highest quality construction, quick delivery and full customization available. Don't be satisfied with inferior imitations or imports.

FS/FSR SERIES CASTERS



2,000 lbs. Maximum Capacity

Top Plate: 4-1/2" x 6-1/4" Mounting Holes: 2-7/16" x 4-15/16" Slotted to 3-3/8" x 5-1/4" BHS 1/2" Hole Clearance



FS-6300-UC-RB

Our "Forged Steel" Series of casters are designed for those rugged use areas. Swivels feature a top plate and yoke wrought from SAE 1045 forged steel. A hardened 3/4" nut & bolt kingpin and double ball race construction, and double welded fork legs make for a very rugged, yet easy swivelling caster. North American made for fast delivery and competitive pricing.



FSR-8300-VGD-RB

Wheel Diam.	OH	Swiv. Rad.
6"	7-1/2"	5-1/2"
8"	10-1/8"	6-1/2"
10"	11-1/2"	7-3/4"
12"	13-1/2"	9"

Swivel Model Number	Rigid Model Number	Tread Width	Wheel Type	Capacity (lbs.)	Bearing Type	Weight (Approx) Swivel	Weight (Approx) Rigid
6" Diameter Wheels							
FS-6250L-BAL-RB	FSR-6250L-BAL-RB	2-1/2"	Phenolic	1600	Roller	13.0	8.5
FS-6250L-DU-RB	FSR-6250L-DU-RB	2-1/2"	Ductile Iron	2000	Roller	20.5	16.0
CONSULT FACTORY	FSR-6250L-VGD-RB	2-1/2"	Ductile Iron (V-Groove)	2000	Roller	20.0	15.5
FS-6250L-UC-RB	FSR-6250L-UC-RB	2-1/2"	Urethane on Cast	1600	Roller	21.5	17.0
FS-6300-BAL-RB	FSR-6300-BAL-RB	3"	Phenolic	2000	Roller	13.5	9.0
FS-6300-LAM-RB	FSR-6300-LAM-RB	3"	Laminated Phenolic	2000	Roller	13.5	9.0
FS-6300-DU-RB	FSR-6300-DU-RB	3"	Ductile Iron	2000	Roller	24.5	20.0
CONSULT FACTORY	FSR-6300-VGD-RB	3"	Ductile Iron (V-Groove)	2000	Roller	22.0	17.5
FS-6300-UC-RB	FSR-6300-UC-RB	3"	Urethane on Cast	2000	Roller	19.5	15.0
FS-6300-MBA-PBB	FSR-6300-MBA-PBB	3"	Megabest	700	Precision Ball	15.0	10.5
FS-6300-RMC-RB	FSR-6300-RMC-RB	3"	Rubber Moldon (H90)	1360	Roller	20.5	16.0
8" Diameter Wheels							
FS-8250L-BAL-RB	FSR-8250L-BAL-RB	2-1/2"	Phenolic	2000	Roller	15.5	10.5
FS-8250L-DU-RB	FSR-8250L-DU-RB	2-1/2"	Ductile Iron	2000	Roller	29.0	24.0
CONSULT FACTORY	FSR-8250L-VGD-RB	2-1/2"	Ductile Iron (V-Groove)	2000	Roller	27.5	22.5
FS-8250L-UC-RB	FSR-8250L-UC-RB	2-1/2"	Urethane on Cast	1800	Roller	22.5	17.5
FS-8300-BAL-RB	FSR-8300-BAL-RB	3"	Phenolic	2000	Roller	16.5	11.5
FS-8300-LAM-RB	FSR-8300-LAM-RB	3"	Laminated Phenolic	2000	Roller	16.5	11.5
FS-8300-DU-RB	FSR-8300-DU-RB	3"	Ductile Iron	2000	Roller	32.0	27.0
CONSULT FACTORY	FSR-8300-VGD-RB	3"	Ductile Iron (V-Groove)	2000	Roller	29.0	24.0
FS-8300-UN-RB	FSR-8300-UN-RB	3"	Star-Tech Urethane	2000	Roller	15.5	10.5
FS-8300-UC-RB	FSR-8300-UC-RB	3"	Urethane on Cast	2000	Roller	25.0	20.0
FS-8300-MBA-PBB	FSR-8300-MBA-PBB	3"	Megabest	850	Precision Ball	18.0	13.0
FS-8300-RMC-RB	FSR-8300-RMC-RB	3"	Rubber Moldon (H90)	1680	Roller	22.0	17.0
10" Diameter Wheels							
FS-10250L-BAL-RB	FSR-10250L-BAL-RB	2-1/2"	Phenolic	2000	Roller	17.5	12.5
FS-10250L-DU-RB	FSR-10250L-DU-RB	2-1/2"	Ductile Iron	2000	Roller	28.0	23.0
FS-10250L-UC-RB	FSR-10250L-UC-RB	2-1/2"	Urethane on Cast	2000	Roller	31.5	26.5
FS-10300-BAL-RB	FSR-10300-BAL-RB	3"	Phenolic	2000	Roller	19.5	14.5
FS-10300-DU-RB	FSR-10300-DU-RB	3"	Ductile Iron	2000	Roller	40.5	35.5
CONSULT FACTORY	FSR-10300-VGD-RB	3"	Ductile Iron (V-Groove)	2000	Roller	36.5	31.5
FS-10300-UC-RB	FSR-10300-UC-RB	3"	Urethane on Cast	2000	Roller	32.5	27.5
FS-10300-RMC-RB	FSR-10300-RMC-RB	3"	Rubber Moldon (H90)	2000	Roller	27.0	22.0
12" Diameter Wheels							
FS-12300-BAL-RB	FSR-12300-BAL-RB	3"	Phenolic	2000	Roller	22.5	17.5
FS-12300-DU-RB	FSR-12300-DU-RB	3"	Ductile Iron	2000	Roller	50.5	45.5
CONSULT FACTORY	FSR-12300-VGD-RB	3"	Ductile Iron (V-Groove)	2000	Roller	46.0	41.0
FS-12300-UC-RB	FSR-12300-UC-RB	3"	Urethane on Cast	2000	Roller	39.0	34.0
FS-12300-RMC-RB	FSR-12300-RMC-RB	3"	Rubber Moldon (H90)	2000	Roller	31.5	26.5

Options: (1) Pedal Brake available on swivels and rigids. Add code 'BR' to model number (eg. FS/BR-8300-DU-RB)
 (2) T-Handle Brake available on swivels and rigids. Add code 'TBR' to model number (eg. FS/TBR-6250L-UC-RB)
 (3) Four Position Swivel Lock. Add code '4SL' to model number (eg. FS/4SL-12300-BAL-RB)

3,500 lbs. Maximum Capacity

Top Plate: 4-1/2" x 6-1/4" Mounting Holes: 2-7/16" x 4-15/16" Slotted to 3-3/8" x 5-1/4" BHS 1/2" Hole Clearance

ALSO AVAILABLE IN STAINLESS STEEL (SEE PAGE 42)

Our LS Series caster uses our PATENTED Double Ball Kingboltless design to eliminate the need for rivets or kingbolts, a common cause of caster failures (see page 15 for full details about our breakthrough design). Not only does this caster offer higher capacities and greater durability than traditional forged head designs; it is engineered to withstand punishing towline and shockload applications that would destroy most ordinary casters!

The LS swivel uses 4-1/2" diameter precision machined and hardened raceways incorporating over fifty 5/16" diameter ball bearings in two raceways, securely welded to an industry standard 4-1/2" x 6-1/4" top plate. The

Wheel Diam.	OH	Swiv. Rad.
6"	7-1/2"	5-1/2"
8"	10-1/8"	6-1/2"
10"	11-1/2"	7-3/4"
12"	13-1/2"	9"

caster is painted with a high gloss black finish and is fitted with a threaded 45° angle grease fitting for easy maintenance. North American made for fast delivery and competitive pricing and are fully customizable upon request.



US Patent #: 5,983,451

Canadian Patent #: 2,179,802

LS-6300-DU-RB

Swivel Model Number	Rigid Model Number	Tread Width	Wheel Type	Capacity (lbs.)	Bearing Type	Weight (Approx)	
						Swivel	Rigid
6" Diameter Wheels							
LS-6250L-BAL-RB	LSR-6250L-BAL-RB	2-1/2"	Phenolic	1600	Roller	13.0	8.5
LS-6250L-DU-RB	LSR-6250L-DU-RB	2-1/2"	Ductile Iron	3500	Roller	20.5	16.0
CONSULT FACTORY	LSR-6250L-VGD-RB	2-1/2"	Ductile Iron (V-Groove)	3500	Roller	20.0	15.5
LS-6250L-UC-RB	LSR-6250L-UC-RB	2-1/2"	Urethane on Cast	1600	Roller	19.0	14.5
LS-6300-BAL-RB	LSR-6300-BAL-RB	3"	Phenolic	2000	Roller	13.5	9.0
LS-6300-LAM-RB	LSR-6300-LAM-RB	3"	Laminated Phenolic	2500	Roller	13.5	9.0
LS-6300-DU-RB	LSR-6300-DU-RB	3"	Ductile Iron	3500	Roller	24.5	20.0
CONSULT FACTORY	LSR-6300-VGD-RB	3"	Ductile Iron (V-Groove)	3500	Roller	22.0	17.5
LS-6300-UC-RB	LSR-6300-UC-RB	3"	Urethane on Cast	2050	Roller	19.5	16.0
LS-6300C-UBA-PBB	LSR-6300C-UBA-PBB	3"	Urethane on Alum. (Crowned)	2100	Precision Ball	14.5	10.0
LS-6300-MBA-PBB	LSR-6300-MBA-PBB	3"	Megabest	700	Precision Ball	15.0	10.5
LS-6300-UDU-RB	LSR-6300-UDU-RB	3"	Urethane on Ductile Iron	3500	Roller	26.0	21.5
LS-6300-RMC-RB	LSR-6300-RMC-RB	3"	Rubber Moldon (H90)	1360	Roller	20.5	16.0
8" Diameter Wheels							
LS-8250L-BAL-RB	LSR-8250L-BAL-RB	2-1/2"	Phenolic	2000	Roller	16.0	10.5
LS-8250L-DU-RB	LSR-8250L-DU-RB	2-1/2"	Ductile Iron	3500	Roller	29.5	24.0
CONSULT FACTORY	LSR-8250L-VGD-RB	2-1/2"	Ductile Iron (V-Groove)	3500	Roller	28.0	22.5
LS-8250L-UC-RB	LSR-8250L-UC-RB	2-1/2"	Urethane on Cast	1800	Roller	23.0	17.5
LS-8300-BAL-RB	LSR-8300-BAL-RB	3"	Phenolic	2500	Roller	17.0	11.5
LS-8300-LAM-RB	LSR-8300-LAM-RB	3"	Laminated Phenolic	3100	Roller	17.0	11.5
LS-8300-DU-RB	LSR-8300-DU-RB	3"	Ductile Iron	3500	Roller	32.5	27.0
CONSULT FACTORY	LSR-8300-VGD-RB	3"	Ductile Iron (V-Groove)	3500	Roller	29.5	24.0
LS-8300-UC-RB	LSR-8300-UC-RB	3"	Urethane on Cast	2500	Roller	25.5	20.0
LS-8300C-UBA-PBB	LSR-8300C-UBA-PBB	3"	Urethane on Alum. (Crowned)	2550	Precision Ball	18.0	12.5
LS-8300-MBA-PBB	LSR-8300-MBA-PBB	3"	Megabest	850	Precision Ball	18.5	13.0
LS-8300-UDU-RB	LSR-8300-UDU-RB	3"	Urethane on Ductile Iron	3500	Roller	28.0	22.5
LS-8300-RMC-RB	LSR-8300-RMC-RB	3"	Rubber Moldon (H90)	1680	Roller	22.5	17.0
10" Diameter Wheels							
LS-10250L-BAL-RB	LSR-10250L-BAL-RB	2-1/2"	Phenolic	2400	Roller	18.0	12.5
LS-10250L-DU-RB	LSR-10250L-DU-RB	2-1/2"	Ductile Iron	3500	Roller	28.5	23.0
LS-10250L-UC-RB	LSR-10250L-UC-RB	2-1/2"	Urethane on Cast	2300	Roller	32.0	26.5
LS-10250SC-UBA-PBB	LSR-10250SC-UBA-PBB	2-1/2"	Urethane on Alum. (Crowned)	3000	Precision Ball	19.0	13.5
LS-10250SC-MBA-PBB	LSR-10250SC-MBA-PBB	2-1/2"	Megabest (Crowned)	1000	Precision Ball	19.0	13.5
LS-10300-BAL-RB	LSR-10300-BAL-RB	3"	Phenolic	2500	Roller	20.0	14.5
LS-10300-DU-RB	LSR-10300-DU-RB	3"	Ductile Iron	3500	Roller	41.0	35.5
CONSULT FACTORY	LSR-10300-VGD-RB	3"	Ductile Iron (V-Groove)	3500	Roller	37.0	31.5
LS-10300-UC-RB	LSR-10300-UC-RB	3"	Urethane on Cast	2800	Roller	33.0	27.5
LS-10300-UDU-RB	LSR-10300-UDU-RB	3"	Urethane on Ductile Iron	3500	Roller	36.5	31.0
LS-10300-RMC-RB	LSR-10300-RMC-RB	3"	Rubber Moldon (H90)	2000	Roller	27.5	22.0
12" Diameter Wheels							
LS-12300-BAL-RB	LSR-12300-BAL-RB	3"	Phenolic	3500	Roller	23.0	17.5
LS-12300-DU-RB	LSR-12300-DU-RB	3"	Ductile Iron	3500	Roller	51.0	45.5
CONSULT FACTORY	LSR-12300-VGD-RB	3"	Ductile Iron (V-Groove)	3500	Roller	46.5	41.0
LS-12300-UC-RB	LSR-12300-UC-RB	3"	Urethane on Cast	3200	Roller	39.5	34.0
LS-12300-UDU-RB	LSR-12300-UDU-RB	3"	Urethane on Ductile Iron	3500	Roller	46.0	40.5
LS-12300-RMC-RB	LSR-12300-RMC-RB	3"	Rubber Moldon (H90)	2280	Roller	32.0	26.5

- Options:**
- (1) Pedal Brake available on swivels and rigids. Add code 'BR' to model number (eg. LS/BR-8300-DU-RB)
 - (2) Poly Cam Brake available on swivels and rigids. Add code 'PCB' to model number (eg. LS/PCB-6300-UC-RB)
 - (3) T-Handle Brake available on swivels and rigids. Add code 'TBR' to model number (eg. LS/TBR-6250L-UC-RB)
 - (4) Four Position Swivel Lock. Add code '4SL' to model number (eg. LS/4SL-12300-BAL-RB)
 - (5) Head Seals available on swivels only. Add code 'HS' to model number. (eg. LS/HS-10250SC-UBA-PBB)
 - (6) Flanged Brass Bearing. Substitute 'BF' for 'RB' in Model Number (eg. LS-6300-LAM-BF)

HX/HXR SERIES CASTERS

3,000 lbs. Maximum Capacity

Top Plate: 5-1/4" x 7-1/4" Mounting Holes: 3-3/8" x 5-1/4" Slotted to 4-1/8" x 6-1/8" BHS 1/2" Hole Clearance



HX/TBR-6300-DU-RB

This heavy-duty caster has SAE 1045 drop-forged swivel assembly complete with 5/16" thick legs welded inside and out. A 1" diameter nut & bolt kingpin and double ball construction make this an ideal caster in severe conditions. A grease fitting is located in the head for easy lubrication.



HXR-10300-VGD-RB

Wheel Diam.	OH	Swiv. Rad.
6"	8"	5-1/4"
8"	10-1/2"	6-1/2"
10"	12-1/2"	7-1/2"
12"	15-1/2"	8-1/2"

Swivel Model Number	Rigid Model Number	Tread Width	Wheel Type	Capacity (lbs.)	Bearing Type	Weight (Approx)	
						Swivel	Rigid
6" Diameter Wheels							
HX-6250L-BAL-RB	HXR-6250L-BAL-RB	2-1/2"	Phenolic	1600	Roller	17.0	14.0
HX-6250L-DU-RB	HXR-6250L-DU-RB	2-1/2"	Ductile Iron	3000	Roller	24.5	21.5
CONSULT FACTORY	HXR-6250L-VGD-RB	2-1/2"	Ductile Iron (V-Groove)	3000	Roller	24.0	21.0
HX-6250L-UC-RB	HXR-6250L-UC-RB	2-1/2"	Urethane on Cast	1600	Roller	23.0	20.0
HX-6300-BAL-RB	HXR-6300-BAL-RB	3"	Phenolic	2000	Roller	17.5	14.5
HX-6300-LAM-RB	HXR-6300-LAM-RB	3"	Laminated Phenolic	2500	Roller	17.5	14.5
HX-6300-DU-RB	HXR-6300-DU-RB	3"	Ductile Iron	3000	Roller	28.5	25.5
CONSULT FACTORY	HXR-6300-VGD-RB	3"	Ductile Iron (V-Groove)	3000	Roller	26.0	23.0
HX-6300-UC-RB	HXR-6300-UC-RB	3"	Urethane on Cast	2050	Roller	23.5	20.5
HX-6300-MBA-PBB	HXR-6300-MBA-PBB	3"	Megabest	700	Precision Ball	19.0	16.0
HX-6300-RMC-RB	HXR-6300-RMC-RB	3"	Rubber Moldon (H90)	1360	Roller	24.5	21.5
8" Diameter Wheels							
HX-8250L-BAL-RB	HXR-8250L-BAL-RB	2-1/2"	Phenolic	2000	Roller	20.0	16.5
HX-8250L-DU-RB	HXR-8250L-DU-RB	2-1/2"	Ductile Iron	3000	Roller	33.5	30.0
CONSULT FACTORY	HXR-8250L-VGD-RB	2-1/2"	Ductile Iron (V-Groove)	3000	Roller	32.0	28.5
HX-8250L-UC-RB	HXR-8250L-UC-RB	2-1/2"	Urethane on Cast	1800	Roller	27.0	23.5
HX-8300-BAL-RB	HXR-8300-BAL-RB	3"	Phenolic	2500	Roller	21.0	17.5
HX-8300-LAM-RB	HXR-8300-LAM-RB	3"	Laminated Phenolic	3000	Roller	21.0	17.5
HX-8300-DU-RB	HXR-8300-DU-RB	3"	Ductile Iron	3000	Roller	36.5	33.0
CONSULT FACTORY	HXR-8300-VGD-RB	3"	Ductile Iron (V-Groove)	3000	Roller	33.5	30.0
HX-8300-UC-RB	HXR-8300-UC-RB	3"	Urethane on Cast	2500	Roller	29.5	26.0
HX-8300-MBA-PBB	HXR-8300-MBA-PBB	3"	Megabest	850	Precision Ball	22.5	19.0
HX-8300-RMC-RB	HXR-8300-RMC-RB	3"	Rubber Moldon (H90)	1680	Roller	26.5	23.0
10" Diameter Wheels							
HX-10250L-BAL-RB	HXR-10250L-BAL-RB	2-1/2"	Phenolic	2400	Roller	23.5	19.5
HX-10250L-DU-RB	HXR-10250L-DU-RB	2-1/2"	Ductile Iron	3000	Roller	32.0	28.0
HX-10250L-UC-RB	HXR-10250L-UC-RB	2-1/2"	Urethane on Cast	2300	Roller	36.5	32.5
HX-10300-BAL-RB	HXR-10300-BAL-RB	3"	Phenolic	2500	Roller	24.5	20.5
HX-10300-DU-RB	HXR-10300-DU-RB	3"	Ductile Iron	3000	Roller	45.5	41.5
CONSULT FACTORY	HXR-10300-VGD-RB	3"	Ductile Iron (V-Groove)	3000	Roller	41.5	37.5
HX-10300-UC-RB	HXR-10300-UC-RB	3"	Urethane on Cast	2800	Roller	37.5	33.5
HX-10300-RMC-RB	HXR-10300-RMC-RB	3"	Rubber Moldon (H90)	2000	Roller	32.0	28.0
12" Diameter Wheels							
HX-12300-BAL-RB	HXR-12300-BAL-RB	3"	Phenolic	3000	Roller	31.0	23.5
HX-12300-DU-RB	HXR-12300-DU-RB	3"	Ductile Iron	3000	Roller	59.0	51.5
CONSULT FACTORY	HXR-12300-VGD-RB	3"	Ductile Iron (V-Groove)	3000	Roller	54.5	47.0
HX-12300-UC-RB	HXR-12300-UC-RB	3"	Urethane on Cast	3000	Roller	47.5	40.0
HX-12300-RMC-RB	HXR-12300-RMC-RB	3"	Rubber Moldon (H90)	2280	Roller	40.0	32.5

Options: (1) T-Handle Brake available on swivels and rigids. Add code 'TBR' to model number (eg. HX/TBR-6250L-UC-RB)
 (2) Four Position Swivel Lock. Add code '4SL' to model number (eg. HX/4SL-12300-BAL-RB)

This robust caster has been designed to incorporate our PATENTED Double Ball Kingboltless raceways (see page 15 for full details about our breakthrough design). The 5-1/2" diameter swivel head, precision machined and heat treated for durability, is locked together by over fifty 3/8" diameter ball bearings. Without a kingpin to bend or break as in traditional forged head designs, this revolutionary caster can withstand punishing towline and shockload applications. The caster is painted with a high gloss black finish and is fitted with a threaded 45° angle grease fitting for easy maintenance. North American made for fast delivery and competitive pricing and are fully customizable upon request.



SX-8300-MBA-PBB

Wheel Diam.	OH	Swiv. Rad.
6"	8"	5-1/4"
8"	10-1/2"	6-1/2"
10"	12-1/2"	7-1/2"
12"	15-1/2"	8-1/2"

US Patent #: 5,983,451

Canadian Patent #: 2,179,802

Swivel Model Number	Rigid Model Number	Tread Width	Wheel Type	Capacity (lbs.)	Bearing Type	Weight (Approx)	
						Swivel	Rigid
6" Diameter Wheels							
SX-6250L-BAL-RB	SXR-6250L-BAL-RB	2-1/2"	Phenolic	1600	Roller	20.5	14.0
SX-6250L-DU-RB	SXR-6250L-DU-RB	2-1/2"	Ductile Iron	3500	Roller	28.0	21.5
CONSULT FACTORY	SXR-6250L-VGD-RB	2-1/2"	Ductile Iron (V-Groove)	3500	Roller	27.5	21.0
SX-6250L-UC-RB	SXR-6250L-UC-RB	2-1/2"	Urethane on Cast	1600	Roller	26.5	20.0
SX-6300-BAL-RB	SXR-6300-BAL-RB	3"	Phenolic	2000	Roller	21.0	14.5
SX-6300-LAM-RB	SXR-6300-LAM-RB	3"	Laminated Phenolic	2500	Roller	21.0	14.5
SX-6300-DU-RB	SXR-6300-DU-RB	3"	Ductile Iron	4600	Roller	32.0	25.5
CONSULT FACTORY	SXR-6300-VGD-RB	3"	Ductile Iron (V-Groove)	4600	Roller	29.5	23.0
SX-6300-UC-RB	SXR-6300-UC-RB	3"	Urethane on Cast	2050	Roller	27.0	20.5
SX-6300C-UBA-PBB	SXR-6300C-UBA-PBB	3"	Urethane on Alum. (Crowned)	2100	Precision Ball	22.0	15.5
SX-6300-MBA-PBB	SXR-6300-MBA-PBB	3"	Megabest	700	Precision Ball	22.5	16.0
SX-6300-UDU-RB	SXR-6300-UDU-RB	3"	Urethane on Ductile Iron	4600	Roller	33.5	27.0
SX-6300-RMC-RB	SXR-6300-RMC-RB	3"	Rubber Moldon (H90)	1360	Roller	28.0	21.5
8" Diameter Wheels							
SX-8250L-BAL-RB	SXR-8250L-BAL-RB	2-1/2"	Phenolic	2000	Roller	23.5	16.5
SX-8250L-DU-RB	SXR-8250L-DU-RB	2-1/2"	Ductile Iron	3500	Roller	35.0	28.0
CONSULT FACTORY	SXR-8250L-VGD-RB	2-1/2"	Ductile Iron (V-Groove)	3500	Roller	29.0	22.0
SX-8250L-UC-RB	SXR-8250L-UC-RB	2-1/2"	Urethane on Cast	1800	Roller	30.5	23.5
SX-8300-BAL-RB	SXR-8300-BAL-RB	3"	Phenolic	2500	Roller	24.5	17.5
SX-8300-LAM-RB	SXR-8300-LAM-RB	3"	Laminated Phenolic	3100	Roller	24.5	17.5
SX-8300-DU-RB	SXR-8300-DU-RB	3"	Ductile Iron	4600	Roller	40.0	33.0
CONSULT FACTORY	SXR-8300-VGD-RB	3"	Ductile Iron (V-Groove)	4600	Roller	37.0	30.0
SX-8300-UC-RB	SXR-8300-UC-RB	3"	Urethane on Cast	2500	Roller	33.0	26.0
SX-8300C-UBA-PBB	SXR-8300C-UBA-PBB	3"	Urethane on Alum. (Crowned)	2550	Precision Ball	25.5	18.5
SX-8300-MBA-PBB	SXR-8300-MBA-PBB	3"	Megabest	850	Precision Ball	26.0	19.0
SX-8300-UDU-RB	SXR-8300-UDU-RB	3"	Urethane on Ductile Iron	4600	Roller	35.5	28.5
SX-8300-RMC-RB	SXR-8300-RMC-RB	3"	Rubber Moldon (H90)	1680	Roller	30.0	23.0
10" Diameter Wheels							
SX-10250L-BAL-RB	SXR-10250L-BAL-RB	2-1/2"	Phenolic	2400	Roller	26.0	18.5
SX-10250L-DU-RB	SXR-10250L-DU-RB	2-1/2"	Ductile Iron	4500	Roller	36.5	29.0
SX-10250L-UC-RB	SXR-10250L-UC-RB	2-1/2"	Urethane on Cast	2300	Roller	40.0	32.5
SX-10250SC-UBA-PBB	SXR-10250SC-UBA-PBB	2-1/2"	Urethane on Alum. (Crowned)	3000	Precision Ball	27.0	19.5
SX-10250SC-MBA-PBB	SXR-10250SC-MBA-PBB	2-1/2"	Megabest (Crowned)	1000	Precision Ball	27.0	19.5
SX-10300-BAL-RB	SXR-10300-BAL-RB	3"	Phenolic	2500	Roller	28.0	20.5
SX-10300-DU-RB	SXR-10300-DU-RB	3"	Ductile Iron	4600	Roller	49.0	41.5
CONSULT FACTORY	SXR-10300-VGD-RB	3"	Ductile Iron (V-Groove)	4600	Roller	45.0	37.5
SX-10300-UC-RB	SXR-10300-UC-RB	3"	Urethane on Cast	2800	Roller	41.0	33.5
SX-10300-UDU-RB	SXR-10300-UDU-RB	3"	Urethane on Ductile Iron	4600	Roller	44.5	37.0
SX-10300-RMC-RB	SXR-10300-RMC-RB	3"	Rubber Moldon (H90)	2000	Roller	35.5	28.0
12" Diameter Wheels							
SX-12300-BAL-RB	SXR-12300-BAL-RB	3"	Phenolic	3500	Roller	32.0	23.5
SX-12300-DU-RB	SXR-12300-DU-RB	3"	Ductile Iron	4600	Roller	60.0	51.5
CONSULT FACTORY	SXR-12300-VGD-RB	3"	Ductile Iron (V-Groove)	4600	Roller	55.5	47.0
SX-12300-UC-RB	SXR-12300-UC-RB	3"	Urethane on Cast	3200	Roller	48.5	40.0
SX-12300-UDU-RB	SXR-12300-UDU-RB	3"	Urethane on Ductile Iron	4600	Roller	55.0	46.5
SX-12300-RMC-RB	SXR-12300-RMC-RB	3"	Rubber Moldon (H90)	2280	Roller	41.0	32.5

- Options:** (1) Poly Cam Brake available on swivels and rigids. Add code 'PCB' to model number (eg. SX/**PCB**-6300-UC-RB)
 (2) T-Handle Brake available on swivels and rigids. Add code 'TBR' to model number (eg. SX/**TBR**-6250L-UC-RB)
 (3) Four Position Swivel Lock. Add code '4SL' to model number (eg. SX/**4SL**-12300-BAL-RB)
 (4) Flanged Brass Bearing. Substitute 'BF' for 'RB' in Model Number (eg. SX-6300-LAM-**BF**)

KP/KPR SERIES KINGBOLTLESS CASTERS



10,000 lbs. Maximum Capacity

Top Plate: 6-1/4" x 7-1/2" Mounting Holes: 4-1/2" x 6" Slotted to 4-1/8" x 6-1/8" BHS 1/2" Hole Clearance



KP-6400-DU-TB

Where high capacity and durability are a must – the KP Series are the casters for you! Using our PATENTED Double Ball Kingboltless design, these casters offer unmatched performance. The super-strength 6-1/2" diameter swivel head is securely welded to the 1/2" top plate. The two precision machined and hardened raceways are locked together by over fifty 1/2" diameter ball bearings. The double raceways make for much easier operation than single race models offered by the competition and the Kingboltless design means the caster can withstand even punishing towline and shockload applications. The caster is painted with a high gloss black finish and is fitted with a threaded 45° angle grease fitting for easy maintenance. North American made for fast delivery and competitive pricing and are fully customizable upon request.

US Patent #: 5,983,451

Canadian Patent #: 2,179,802

Wheel Diam.	OH	Swiv. Rad.
6"	8-1/2"	4-3/4"
8"	10-1/2"	6-3/16"
10"	12-1/2"	7-11/16"
12"	15-1/2"	9-5/8"

Swivel Model Number	Rigid Model Number	Tread Width	Wheel Type	Capacity (lbs.)	Bearing Type	Weight (Approx)	
						Swivel	Rigid
6" Diameter Wheels							
KP-6300-LAM-RB	KPR-6300-LAM-RB	3"	Laminated Phenolic	2500	Roller	30.0	17.5
KP-6300-DU-RB	KPR-6300-DU-RB	3"	Ductile Iron	6000	Roller	41.0	28.5
CONSULT FACTORY	KPR-6300-VGD-RB	3"	Ductile Iron (V-Groove)	5000	Roller	38.5	26.0
KP-6300-UC-RB	KPR-6300-UC-RB	3"	Urethane on Cast	2050	Roller	36.0	23.5
KP-6300-UDU-RB	KPR-6300-UDU-RB	3"	Urethane on Ductile Iron	5000	Roller	42.5	30.0
KP-6400-DU-TB	KPR-6400-DU-TB	4"	Ductile Iron	10000	Tapered	46.5	34.0
CONSULT FACTORY	KPR-6400-VGD-TB	4"	Ductile Iron (V-Groove)	10000	Tapered	43.0	30.5
KP-6400-UC-TB	KPR-6400-UC-TB	4"	Urethane on Cast	5750	Tapered	45.0	32.5
KP-6400-UDU-TB	KPR-6400-UDU-TB	4"	Urethane on Ductile Iron	10000	Tapered	46.0	33.5
8" Diameter Wheels							
KP-8300-LAM-RB	KPR-8300-LAM-RB	3"	Laminated Phenolic	3100	Roller	33.0	20.5
KP-8300-DU-RB	KPR-8300-DU-RB	3"	Ductile Iron	6000	Roller	48.5	36.0
CONSULT FACTORY	KPR-8300-VGD-RB	3"	Ductile Iron (V-Groove)	5000	Roller	45.5	33.0
KP-8300-UC-RB	KPR-8300-UC-RB	3"	Urethane on Cast	2500	Roller	41.5	29.0
KP-8300-UDU-RB	KPR-8300-UDU-RB	3"	Urethane on Ductile Iron	6000	Roller	44.0	31.5
KP-8400-DU-TB	KPR-8400-DU-TB	4"	Ductile Iron	10000	Tapered	56.0	43.0
CONSULT FACTORY	KPR-8400-VGD-TB	4"	Ductile Iron (V-Groove)	10000	Tapered	51.5	38.5
KP-8400-UC-TB	KPR-8400-UC-TB	4"	Urethane on Cast	5750	Tapered	50.5	37.5
KP-8400-UDU-TB	KPR-8400-UDU-TB	4"	Urethane on Ductile Iron	10000	Tapered	51.5	38.5
10" Diameter Wheels							
KP-10300-DU-RB	KPR-10300-DU-RB	3"	Ductile Iron	6000	Roller	58.0	45.0
CONSULT FACTORY	KPR-10300-VGD-RB	3"	Ductile Iron (V-Groove)	5000	Roller	54.0	51.0
KP-10300-UC-RB	KPR-10300-UC-RB	3"	Urethane on Cast	2800	Roller	50.0	47.0
KP-10300-UDU-RB	KPR-10300-UDU-RB	3"	Urethane on Ductile Iron	6000	Roller	53.5	50.5
KP-10400-DU-TB	KPR-10400-DU-TB	4"	Ductile Iron	10000	Tapered	67.0	54.0
CONSULT FACTORY	KPR-10400-VGD-TB	4"	Ductile Iron (V-Groove)	10000	Tapered	61.5	48.5
KP-10400-UC-TB	KPR-10400-UC-TB	4"	Urethane on Cast	5750	Tapered	57.0	44.0
KP-10400-UDU-TB	KPR-10400-UDU-TB	4"	Urethane on Ductile Iron	10000	Tapered	62.0	49.0
12" Diameter Wheels							
KP-12300-DU-RB	KPR-12300-DU-RB	3"	Ductile Iron	6000	Roller	69.0	56.0
CONSULT FACTORY	KPR-12300-VGD-RB	3"	Ductile Iron (V-Groove)	5000	Roller	64.5	51.5
KP-12300-UC-RB	KPR-12300-UC-RB	3"	Urethane on Cast	3200	Roller	57.5	44.5
KP-12300-UDU-RB	KPR-12300-UDU-RB	3"	Urethane on Ductile Iron	6000	Roller	64.0	51.0
KP-12400-DU-TB	KPR-12400-DU-TB	4"	Ductile Iron	10000	Tapered	74.0	61.0
CONSULT FACTORY	KPR-12400-VGD-TB	4"	Ductile Iron (V-Groove)	10000	Tapered	67.5	54.5
KP-12400-UC-TB	KPR-12400-UC-TB	4"	Urethane on Cast	5750	Tapered	65.5	52.5
KP-12400-UDU-TB	KPR-12400-UDU-TB	4"	Urethane on Ductile Iron	10000	Tapered	74.5	61.5

- Options:**
- (1) Poly Cam Brake available on swivels and rigids. Add code 'PCB' to model number (eg. KP/**PCB**-8300-UDU-RB)
 - (2) T-Handle Brake available on swivels and rigids. Add code 'TBR' to model number (eg. KP/**TBR**-10300-UC-RB)
 - (3) Four Position Swivel Lock. Add code '4SL' to model number (eg. KP/**4SL**-8400-DU-TB)
 - (4) Optional IH top plate (8-1/2" x 8-1/2" c/w 7" x 7" BHS). Add code 'IH' to model number (eg. KPR/**IH**-6300-LAM-RB)

This super heavy-duty caster can't be beat! Swivels feature our PATENTED Double Ball Kingboltless design (see page 15 for full details about our breakthrough design). The IH Series offers extreme capacity and superb durability in a fully towable caster. The super-strong 7-1/2" diameter swivel head has two precision machined and hardened raceways locked together by over fifty 5/8" diameter ball bearings. With 1/2" thick top plate and formed steel legs and 1-1/4" axle, this caster is quite simply the best heavy-duty caster on the market. The double raceways make for much easier operation than single raceway models offered by the competition and the Kingboltless design means the caster can withstand punishing towline and shockload applications. The caster is painted with a high gloss black finish and is fitted with a threaded 45° angle grease fitting for easy maintenance. North American made for fast delivery and competitive pricing and are fully customizable upon request.



IH-10400-UC-TB

Wheel Diam.	OH	Swiv. Rad.
6"	9"	5-3/8"
8"	11"	6-9/16"
10"	13"	7-3/8"
12"	15"	8-9/16"
14"	17"	10-5/8"
16"	19"	12-7/8"

US Patent #: 5,983,451

Canadian Patent #: 2,179,802

Swivel Model Number	Rigid Model Number	Tread Width	Wheel Type	Capacity (lbs.)	Bearing Type	Weight (Approx) Swivel	Weight (Approx) Rigid
6" Diameter Wheels							
IH-6400-DU-TB	IHR-6400-DU-TB	4"	Ductile Iron	17000	Tapered	63.0	41.5
CONSULT FACTORY	IHR-6400-VGD-TB	4"	Ductile Iron (V-Groove)	17000	Tapered	59.5	38.0
IH-6400-UC-TB	IHR-6400-UC-TB	4"	Urethane on Cast	5750	Tapered	61.5	40.0
IH-6400-UDU-TB	IHR-6400-UDU-TB	4"	Urethane on Ductile Iron	17000	Tapered	62.5	41.0
8" Diameter Wheels							
IH-8400-DU-TB	IHR-8400-DU-TB	4"	Ductile Iron	17000	Tapered	73.0	50.5
CONSULT FACTORY	IHR-8400-VGD-TB	4"	Ductile Iron (V-Groove)	17000	Tapered	68.5	46.0
IH-8400-UC-TB	IHR-8400-UC-TB	4"	Urethane on Cast	5750	Tapered	67.5	45.0
IH-8400-UDU-TB	IHR-8400-UDU-TB	4"	Urethane on Ductile Iron	17000	Tapered	68.5	46.0
10" Diameter Wheels							
IH-10400-DU-TB	IHR-10400-DU-TB	4"	Ductile Iron	17000	Tapered	84.5	62.5
CONSULT FACTORY	IHR-10400-VGD-TB	4"	Ductile Iron (V-Groove)	17000	Tapered	79.0	57.0
IH-10400-UC-TB	IHR-10400-UC-TB	4"	Urethane on Cast	5750	Tapered	74.5	52.5
IH-10400-UDU-TB	IHR-10400-UDU-TB	4"	Urethane on Ductile Iron	17000	Tapered	79.5	57.5
12" Diameter Wheels							
IH-12400-DU-TB	IHR-12400-DU-TB	4"	Ductile Iron	17000	Tapered	91.5	70.0
CONSULT FACTORY	IHR-12400-VGD-TB	4"	Ductile Iron (V-Groove)	17000	Tapered	85.0	63.5
IH-12400-UC-TB	IHR-12400-UC-TB	4"	Urethane on Cast	5750	Tapered	83.0	61.5
IH-12400-UDU-TB	IHR-12400-UDU-TB	4"	Urethane on Ductile Iron	17000	Tapered	92.0	70.5
14" Diameter Wheels							
IH-14500-DU-TB	IHR-14500-DU-TB	5"	Ductile Iron	25000	Tapered	146.0	124.0
CONSULT FACTORY	IHR-14500-VGD-TB	5"	Ductile Iron (V-Groove)	25000	Tapered	139.0	117.0
16" Diameter Wheels							
IH-16500-UC-TB	IHR-16500-UC-TB	5"	Urethane on Cast	8400	Tapered	124.5	102.5
IH-16500-UDU-TB	IHR-16500-UDU-TB	5"	Urethane on Ductile Iron	25000	Tapered	157.0	135.0

- Options:** (1) Poly Cam Brake available on swivels and rigids. Add code 'PCB' to model number (eg. IH/PCB-8400-UDU-TB)
 (2) T-Handle Brake available on swivels and rigids. Add code 'TBR' to model number (eg. IH/TBR-10400-UC-TB)
 (3) Four Position Swivel Lock. Add code '4SL' to model number (eg. IH/4SL-8400-DU-TB)

SPECIALS ARE OUR SPECIALTY!

With Bestway you are dealing with the manufacturer direct. That means that just because you don't see it in our catalogue it doesn't mean you can't have it. We manufacture our own casters and wheels, so if you have special requirements or specifications you need to match call us - we can make it for you!

Here's just a sample of the 'Made To Order' items available from Bestway:

- Special Top Plates and Bolt Hole Patterns
- Custom Stems and Stem Casters
- Made to Order Spanner Bushings, Axles and Top Hats
- Custom Durometer Polyurethanes
- Toe Guards, Single Leg Casters & Custom Twin Wheel Models
- Custom Wheel Sizes
- Non-Standard Overall Heights
- Custom Bore Sizes, Inserts and Keyways
- Special V-Grooves and Flanged Wheels
- No Minimum Quantity and Quick Delivery

TWLE/TWLER SERIES TWIN WHEEL CASTERS (formerly TWLS/TWLSR Series 2" Face)



3,400 lbs. Maximum Capacity

Top Plate: 4-1/2" x 6-1/4" Mounting Holes: 2-7/16" x 4-15/16" Slotted to 3-3/8" x 5-1/4" BHS 1/2" Hole Clearance

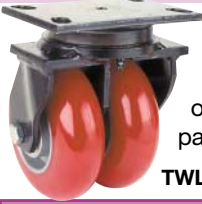

This twin wheel version of our popular LE Series caster is ideal for applications where maximum mobility is required. These casters offer all of the advantages of our PATENTED Double Ball Kingboltless design combined with the greater ease of operation afforded by twin wheel models (see facing page). This caster is painted with a high gloss black finish and is fitted with a threaded 45° angle grease fitting for easy maintenance.

TWLE-6200C-UBA-PBB

Wheel Diam.	OH	Swiv. Rad.
4"	6"	3-3/4"
5"	7"	4"
6"	8"	5"
8"	10"	6-3/4"

Swivel Model Number	Rigid Model Number	Wheel Type	Capacity (lbs.)	Bearing Type	Weight (Approx) Swivel	Weight (Approx) Rigid
Dual 4" x 2" Wheels						
TWLE-4200-BAL-RB	TWLER-4200-BAL-RB	Phenolic	1600	Roller	12.5	9.5
TWLE-4200-LAM-RB	TWLER-4200-LAM-RB	Laminated Phenolic	2250	Roller	12.5	9.5
TWLE-4200-HT-RB	TWLER-4200-HT-RB	Hi-Temp Phenolic	950	Roller	12.5	9.5
TWLE-4200C-DU-RB	TWLER-4200C-DU-RB	Ductile Iron (Crowned)	3400	Roller	19.5	16.5
TWLE-4200-MS-RB	TWLER-4200-MS-RB	Machined Steel	3400	Roller	27.5	24.5
TWLE-4200-UN-RB	TWLER-4200-UN-RB	Star-Tech Urethane	1100	Roller	11.5	8.5
TWLE-4200-UC-RB	TWLER-4200-UC-RB	Urethane on Cast	1300	Roller	15.5	12.5
TWLE-4200C-UC-RB	TWLER-4200C-UC-RB	Urethane on Cast (Crowned)	1500	Roller	15.5	12.5
TWLE-4200C-UBA-PBB	TWLER-4200C-UBA-PBB	Urethane on Alum. (Crowned)	1700	Precision Ball	13.5	10.5
TWLE-4200C-MBA-PBB	TWLER-4200C-MBA-PBB	Megabest (Crowned)	550	Precision Ball	13.5	10.5
TWLE-4200C-ES-PBB	TWLER-4200C-ES-PBB	Solid Elastomer (Crowned)	1500	Precision Ball	12.5	9.5
TWLE-4200-EL-RB	TWLER-4200-EL-RB	Eliminator Grey Rubber	1100	Roller	11.5	8.5
Dual 5" x 2" Wheels						
TWLE-5200-BAL-RB	TWLER-5200-BAL-RB	Phenolic	1900	Roller	14.5	11.0
TWLE-5200-LAM-RB	TWLER-5200-LAM-RB	Laminated Phenolic	2650	Roller	14.5	11.0
TWLE-5200-HT-RB	TWLER-5200-HT-RB	Hi-Temp Phenolic	1400	Roller	14.5	11.0
TWLE-5200C-DU-RB	TWLER-5200C-DU-RB	Ductile Iron (Crowned)	3400	Roller	20.5	17.0
TWLE-5200-MS-RB	TWLER-5200-MS-RB	Machined Steel	3400	Roller	38.5	35.0
TWLE-5200-UN-RB	TWLER-5200-UN-RB	Star-Tech Urethane	1400	Roller	13.5	10.0
TWLE-5200-UC-RB	TWLER-5200-UC-RB	Urethane on Cast	1950	Roller	17.5	14.0
TWLE-5200C-UC-RB	TWLER-5200C-UC-RB	Urethane on Cast (Crowned)	1900	Roller	17.5	14.0
TWLE-5200C-UBA-PBB	TWLER-5200C-UBA-PBB	Urethane on Alum. (Crowned)	1700	Precision Ball	14.5	11.0
TWLE-5200C-MBA-PBB	TWLER-5200C-MBA-PBB	Megabest (Crowned)	550	Precision Ball	14.5	11.0
TWLE-5200C-ES-PBB	TWLER-5200C-ES-PBB	Solid Elastomer (Crowned)	1900	Precision Ball	13.5	10.0
TWLE-5200-EL-RB	TWLER-5200-EL-RB	Eliminator Grey Rubber	1300	Roller	13.5	10.0
Dual 6" x 2" Wheels						
TWLE-6200-BAL-RB	TWLER-6200-BAL-RB	Phenolic	2250	Roller	17.0	13.0
TWLE-6200-LAM-RB	TWLER-6200-LAM-RB	Laminated Phenolic	2850	Roller	17.0	13.0
TWLE-6200-HT-RB	TWLER-6200-HT-RB	Hi-Temp Phenolic	1700	Roller	17.0	13.0
TWLE-6200C-DU-RB	TWLER-6200C-DU-RB	Ductile Iron (Crowned)	3400	Roller	26.0	22.0
TWLE-6200-MS-RB	TWLER-6200-MS-RB	Machined Steel	3400	Roller	51.0	47.0
TWLE-6200-UN-RB	TWLER-6200-UN-RB	Star-Tech Urethane	1700	Roller	25.0	11.0
TWLE-6200-UC-RB	TWLER-6200-UC-RB	Urethane on Cast	2300	Roller	20.0	16.0
TWLE-6200C-UC-RB	TWLER-6200C-UC-RB	Urethane on Cast (Crowned)	1950	Roller	20.0	16.0
TWLE-6200C-UBA-PBB	TWLER-6200C-UBA-PBB	Urethane on Alum. (Crowned)	2250	Precision Ball	17.0	13.0
TWLE-6200C-MBA-PBB	TWLER-6200C-MBA-PBB	Megabest (Crowned)	750	Precision Ball	17.0	13.0
TWLE-6200-ES-PBB	TWLER-6200-ES-PBB	Solid Elastomer	2250	Precision Ball	16.0	12.0
TWLE-6200C-ES-PBB	TWLER-6200C-ES-PBB	Solid Elastomer (Crowned)	2250	Precision Ball	16.0	12.0
TWLE-6200C-EG-PBB	TWLER-6200C-EG-PBB	Elastiglide (Crowned)	2250	Precision Ball	17.0	13.0
TWLE-6200-EL-RB	TWLER-6200-EL-RB	Eliminator Grey Rubber	1700	Roller	15.0	11.0
Dual 8" x 2" Wheels						
TWLE-8200-BAL-RB	TWLER-8200-BAL-RB	Phenolic	2650	Roller	19.0	15.5
TWLE-8200-LAM-RB	TWLER-8200-LAM-RB	Laminated Phenolic	3200	Roller	19.0	15.5
TWLE-8200-HT-RB	TWLER-8200-HT-RB	Hi-Temp Phenolic	2050	Roller	19.0	15.5
TWLE-8200C-DU-RB	TWLER-8200C-DU-RB	Ductile Iron (Crowned)	3400	Roller	35.0	31.5
TWLE-8200-UN-RB	TWLER-8200-UN-RB	Star-Tech Urethane	1900	Roller	16.0	12.5
TWLE-8200-UC-RB	TWLER-8200-UC-RB	Urethane on Cast	2850	Roller	25.0	21.5
TWLE-8200C-UC-RB	TWLER-8200C-UC-RB	Urethane on Cast (Crowned)	2350	Roller	24.0	20.5
TWLE-8200C-UBA-PBB	TWLER-8200C-UBA-PBB	Urethane on Alum. (Crowned)	2850	Precision Ball	21.0	17.5
TWLE-8200C-MBA-PBB	TWLER-8200C-MBA-PBB	Megabest (Crowned)	950	Precision Ball	22.0	18.5
TWLE-8200-ES-PBB	TWLER-8200-ES-PBB	Solid Elastomer	3000	Precision Ball	18.0	14.5
TWLE-8200C-ES-PBB	TWLER-8200C-ES-PBB	Solid Elastomer (Crowned)	3000	Precision Ball	21.0	17.5
TWLE-8200C-EG-PBB	TWLER-8200C-EG-PBB	Elastiglide (Crowned)	2850	Precision Ball	22.0	18.5
TWLE-8200-EL-RB	TWLER-8200-EL-RB	Eliminator Grey Rubber	1700	Roller	16.0	12.5

- Options:**
- (1) Poly Cam Brake available on swivels and rigids. Add code 'PCB' to model number (eg. TWLE/PCB-6200-UC-RB)
 - (2) T-Handle Brake available on swivels and rigids. Add code 'TBR' to model number (eg. TWLER/TBR-4200-BAL-RB)
 - (3) Four Position Swivel Lock. Will increase OH. Add code '4SL' to model number (eg. TWLE/4SL-8200C-DU-RB)
 - (4) Head Seals available on swivels only. Add code 'HS' to model number. (eg. TWLE/HS-4200-EL-RB)
 - (5) Heavy Duty Roller Bearing. Substitute 'HRB' for 'RB' in Model Number (eg. TWLE-6200C-DU-HRB)
 - (6) Flanged Brass Bearing. Substitute 'BF' for 'RB' in Model Number (eg. TWLE-6200-HT-BF)

This twin wheel version of our proven IH Series caster combines unmatched strength, durability and mobility. Swivels use the same super high-capacity PATENTED Double Ball Kingboltless head as our single wheel version, combined with the greater ease of operation afforded by twin wheel models (see below). This caster is painted with a high gloss black finish and is fitted with a threaded 45° angle grease fitting for easy maintenance. If extreme capacity and great mobility are a must, then this is the caster for you.



TWIH-12400-DU-TB

Wheel Diam.	OH	Swiv. Rad.
6"	9-1/2"	6-3/4"
8"	11-1/2"	7-3/4"
10"	13-1/2"	8-3/8"
12"	15-1/2"	9-1/2"

US Patent #: 5,983,451

Canadian Patent #: 2,179,802

Swivel Model Number	Rigid Model Number	Wheel Type	Capacity (lbs.)	Bearing Type	Weight (Approx)	
					Swivel	Rigid
Dual 6" x 4" Wheels						
TWIH-6400-DU-TB	TWIHR-6400-DU-TB	Ductile Iron	25000	Tapered	98.5	78.0
TWIH-6400-UC-TB	TWIHR-6400-UC-TB	Urethane on Cast	10900	Tapered	95.5	75.0
TWIH-6400-UDU-TB	TWIHR-6400-UDU-TB	Urethane on Ductile Iron	25000	Tapered	97.5	77.0
Dual 8" x 4" Wheels						
TWIH-8400-DU-TB	TWIHR-8400-DU-TB	Ductile Iron	25000	Tapered	118.0	97.0
TWIH-8400-UC-TB	TWIHR-8400-UC-TB	Urethane on Cast	10900	Tapered	107.0	86.0
TWIH-8400-UDU-TB	TWIHR-8400-UDU-TB	Urethane on Ductile Iron	25000	Tapered	109.0	88.0
Dual 10" x 4" Wheels						
TWIH-10400-DU-TB	TWIHR-10400-DU-TB	Ductile Iron	25000	Tapered	139.0	119.5
TWIH-10400-UC-TB	TWIHR-10400-UC-TB	Urethane on Cast	10900	Tapered	119.0	99.5
TWIH-10400-UDU-TB	TWIHR-10400-UDU-TB	Urethane on Ductile Iron	25000	Tapered	129.0	109.5
Dual 12" x 4" Wheels						
TWIH-12400-DU-TB	TWIHR-12400-DU-TB	Ductile Iron	25000	Tapered	153.0	132.0
TWIH-12400-UC-TB	TWIHR-12400-UC-TB	Urethane on Cast	10900	Tapered	136.0	115.0
TWIH-12400-UDU-TB	TWIHR-12400-UDU-TB	Urethane on Ductile Iron	25000	Tapered	154.0	133.0

- Options:** (1) Poly Cam Brake available on swivels and rigids. Add code 'PCB' to model number (eg. TWIH/**PCB**-8400-UDU-TB)
 (2) T-Handle Brake available on swivels and rigids. Add code 'TBR' to model number (eg. TWIH/**TBR**-10400-UC-TB)
 (3) Four Position Swivel Lock. Will increase OH. Add code '4SL' to model number (eg. TWIH/**4SL**-8400-DU-TB)

THE ADVANTAGE OF TWIN WHEEL CASTERS

Is it true that two are better than one? In the case of Casters the answer may be YES!

With Bestway's revolutionary Double Ball Kingboltless Caster design, the primary limiting factor on the capacity of the caster is typically the wheel, not the caster itself. By using a twin wheel design you are splitting the caster's weight load between two wheels rather than placing it all on one wheel, thus increasing the overall capacity of the caster.

The other main advantage of twin wheel casters over single wheel models is the increased mobility they provide. It is much easier to change the direction of a twin wheel caster than a single wheel caster with a wide face wheel. This is because twin wheel casters have the advantage of "differential action" when they swivel. When you attempt to change direction with a single wheel caster you must pivot the wheel around its centre point - in effect twisting it across the floor surface. The greater the load on the caster and the wider the wheel face, the more force required and the greater potential for damage to the floor surface, or the tread material of the wheel.

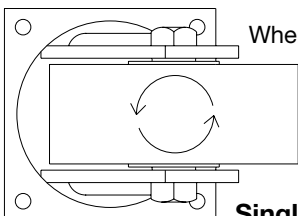

When turning a twin wheel model the caster must still pivot around its centre point. However, because there are two wheels instead of one, nothing must be twisted in place. One wheel rolls in a forward direction while the other rolls backward. Not only does this require much less force, but it also affords much greater protection to both the floor surface and the face of the wheels.

Single Wheel Caster Turning

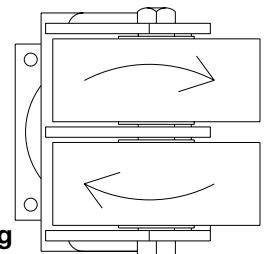

Dual Wheel Caster Turning

We show two of our most commonly requested twin wheel caster series on these pages, but we can create twin wheel versions of any of our Patented Double Ball Kingboltless Caster series (including LS, SX and KP models). And because we manufacture our own casters we can create custom twin wheel casters to match your special requirements. Like all Bestway "Made To Order" items, we offer quick delivery and there is no minimum quantity.

LB SERIES "LIGHT BOLTHOLE" CASTERS

(formerly LBH Series)



230 lbs. Maximum Capacity

Bolt Hole Clearance: 1/2". Standard and Custom Stems Available (Consult Factory).

ALSO AVAILABLE IN STAINLESS STEEL (SEE PAGE 31)



This light duty bolthole caster is designed for applications where top plate mounting is impractical. Using the same double ball raceway construction as our popular LP Series, this caster can be mounted from the underside with a nut & bolt or by any variety of standard and custom stems available from our machine shop. Zinc plated finish and head seals are standard.

LB-3125-BAL

See Page 26 For Standard Stem Options

Wheel Diam.	OH	Swiv. Rad.
3"	4"	3-1/8"
4"	5"	3-1/4"
5"	6"	4"

Swivel Model Number	Tread Width	Wheel Type	Capacity (lbs.)	Bearing Type	Weight (Approx)
3" Diameter Wheels					
LB-3125-BAL	1-1/4"	Phenolic	230	Plain	1.5
LB-3125-BST	1-1/4"	Cast Steel	230	Plain	2.5
LB-3125C-BST-RB	1-1/4"	Cast Steel (Crowned)	230	Roller	3.0
LB-3125-UN-BB	1-1/4"	Star-Tech Urethane	230	Ball Bearing	1.5
LB-3125-MR	1-1/4"	Multi-Purpose Rubber	210	Plain	1.5
LB-3125-EL-BB	1-1/4"	Eliminator Grey Rubber	200	Ball Bearing	1.5
LB-3125-NL	1-1/4"	Ny-Lite	230	Plain	1.5
LB-3125-WNL	1-1/4"	White Poly-Olefin	230	Plain	1.5
LB-3150-BAL-RB	1-1/2"	Phenolic	230	Roller	2.0
LB-3150-BST-RB	1-1/2"	Cast Steel	230	Roller	3.5
LB-3150-UC-RB	1-1/2"	Urethane on Cast	230	Roller	3.0
LB-3150C-ES-HRB	1-1/2"	Solid Elastomer (Crowned)	230	HD Roller	2.0
LB-3150-NY-RB	1-1/2"	White Nylon	230	Roller	2.0
LB-3150-EAS-PBB	1-1/2"	Anti-Static Elastomer	230	Precision Ball	2.0
LB-080-HTM-HL	35mm	Hi-Temp Monolithic	220	Hi-Lex	1.5
4" Diameter Wheels					
LB-4125-BAL	1-1/4"	Phenolic	230	Plain	2.0
LB-4125-BST	1-1/4"	Cast Steel	230	Plain	3.0
LB-4125-UN-BB	1-1/4"	Star-Tech Urethane	230	Ball Bearing	2.0
LB-4125-EL-BB	1-1/4"	Eliminator Grey Rubber	220	Ball Bearing	2.0
LB-4125-NL	1-1/4"	Ny-Lite	230	Plain	1.5
LB-4125-WNL	1-1/4"	White Poly-Olefin	230	Plain	1.5
LB-4138-MR	1-3/8"	Multi-Purpose Rubber	230	Plain	2.5
LB-4150-BAL-RB	1-1/2"	Phenolic	230	Roller	2.0
LB-4150-HT-RB	1-1/2"	Hi-Temp Phenolic	230	Roller	2.0
LB-4150-BST	1-1/2"	Cast Steel	230	Plain	4.0
LB-4150-BST-RB	1-1/2"	Cast Steel	230	Roller	4.0
LB-4150-UN-RB	1-1/2"	Star-Tech Urethane	230	Roller	2.0
LB-4150-UC-RB	1-1/2"	Urethane on Cast	230	Roller	3.0
LB-4150C-ES-HRB	1-1/2"	Solid Elastomer (Crowned)	230	HD Roller	2.0
LB-4150-MR-RB	1-1/2"	Multi-Purpose Rubber	230	Roller	2.5
LB-4150-EL-RB	1-1/2"	Eliminator Grey Rubber	230	Roller	2.0
LB-4150-RMC-RB	1-1/2"	Rubber Moldon (H90)	230	Roller	3.5
LB-4150-NL-RB	1-1/2"	Ny-Lite	230	Roller	2.0
LB-4150-NY-RB	1-1/2"	White Nylon	230	Roller	2.0
LB-4150-EAS-PBB	1-1/2"	Anti-Static Elastomer	230	Precision Ball	2.0
LB-100-HTM-HL	35mm	Hi-Temp Monolithic	230	Hi-Lex	2.0
5" Diameter Wheels					
LB-5125-BAL	1-1/4"	Phenolic	230	Plain	2.0
LB-5125-UN-BB	1-1/4"	Star-Tech Urethane	230	Ball Bearing	2.0
LB-5125-EL-BB	1-1/4"	Eliminator Grey Rubber	230	Ball Bearing	2.0
LB-5125-NL	1-1/4"	Ny-Lite	230	Plain	1.5
LB-5125-WNL	1-1/4"	White Poly-Olefin	230	Plain	1.5
LB-5138-MR	1-3/8"	Multi-Purpose Rubber	230	Plain	2.5
LB-5150-BAL-RB	1-1/2"	Phenolic	230	Roller	2.5
LB-5150-BST-RB	1-1/2"	Cast Steel	230	Roller	4.0
LB-5150-UN-RB	1-1/2"	Star-Tech Urethane	230	Roller	2.0
LB-5150-UC-RB	1-1/2"	Urethane on Cast	230	Roller	4.0
LB-5150C-ES-HRB	1-1/2"	Solid Elastomer (Crowned)	230	HD Roller	2.5
LB-5150-MR-RB	1-1/2"	Multi-Purpose Rubber	230	Roller	3.0
LB-5150-EL-RB	1-1/2"	Eliminator Grey Rubber	230	Roller	2.0
LB-5150-RMC-RB	1-1/2"	Rubber Moldon (H90)	230	Roller	4.0
LB-5150-NL-RB	1-1/2"	Ny-Lite	230	Roller	2.0
LB-5150-NY-RB	1-1/2"	White Nylon	230	Roller	2.5
LB-5150-EAS-PBB	1-1/2"	Anti-Static Elastomer	230	Precision Ball	2.5

- Options:** (1) For Side Pedal Brake add code 'BR' to model number (eg. LB/**BR**-5150-UC-RB)
 (2) Delrin Bearing. Substitute 'DEL' for 'RB' or 'BB' in Model Number (eg. LB-3150-NY-**DEL**)
 (3) Custom stems available. Consult Factory. (See page 26 for standard stem options).

Notes: Listed capacities are for casters only (without stems). Some stems may reduce the above listed capacities. Consult Factory.

500 lbs. Maximum Capacity

Bolt Hole Clearance: 12.2mm (1/2" Optional). Standard and Custom Stems Available (Consult Factory).

ALSO AVAILABLE IN STAINLESS STEEL (SEE PAGE 33)

This medium-duty bolthole caster offers the same high quality construction as our very popular GP Series. The optional "Total Lock Brake" which locks both the wheel and swivel with one push of the pedal makes this an ideal multi-purpose caster. A wide variety of standard or custom stems are available from our machine shop to make mounting easy whatever your application. Double ball race construction and zinc plating are standard.



BH-4125-EL-BB
C/W BH STEM: 7/8" x 2" SC



BH-4150-BAL-RB



BH/TLB-4150-NL-RB

Wheel Diam.	OH	Swiv. Rad.
3"	4"	3"
4"	4-15/16"	3-1/2"
5"	6"	4-1/4"
6"	7"	4-3/4"

See Page 26 For Standard Stem Options

Swivel Model Number	Tread Width	Wheel Type	Capacity (lbs.)	Bearing Type	Weight (Approx)
3" Diameter Wheels					
BH-3125-BAL	1-1/4"	Phenolic	300	Plain	1.5
BH-3125-BST	1-1/4"	Cast Steel	300	Plain	2.5
BH-3125C-BST-RB	1-1/4"	Cast Steel (Crowned)	300	Roller	3.0
BH-3125-UN-BB	1-1/4"	Star-Tech Urethane	250	Ball Bearing	1.5
BH-3125-MR	1-1/4"	Multi-Purpose Rubber	210	Plain	1.5
BH-3125-EL-BB	1-1/4"	Eliminator Grey Rubber	200	Ball Bearing	1.5
BH-3125-NL	1-1/4"	Ny-Lite	275	Plain	1.5
BH-3125-WNL	1-1/4"	White Poly-Olefin	275	Plain	1.5
BH-3150-BAL-RB	1-1/2"	Phenolic	300	Roller	2.0
BH-3150-BST-RB	1-1/2"	Cast Steel	300	Roller	3.5
BH-3150-UC-RB	1-1/2"	Urethane on Cast	300	Roller	3.0
BH-3150C-ES-HRB	1-1/2"	Solid Elastomer (Crowned)	300	HD Roller	2.0
BH-3150-NY-RB	1-1/2"	White Nylon	300	Roller	2.0
BH-3150-EAS-PBB	1-1/2"	Anti-Static Elastomer	300	Precision Ball	2.0
BH-080-HTM-HL	35mm	Hi-Temp Monolithic	220	Hi-Lex	1.5
4" Diameter Wheels					
BH-4125-BAL	1-1/4"	Phenolic	300	Plain	2.5
BH-4125-BST	1-1/4"	Cast Steel	350	Plain	3.5
BH-4125-UN-BB	1-1/4"	Star-Tech Urethane	250	Ball Bearing	2.5
BH-4125-EL-BB	1-1/4"	Eliminator Grey Rubber	220	Ball Bearing	2.5
BH-4125-NL	1-1/4"	Ny-Lite	300	Plain	2.0
BH-4125-WNL	1-1/4"	White Poly-Olefin	300	Plain	2.0
BH-4138-MR	1-3/8"	Multi-Purpose Rubber	300	Plain	3.0
BH-4150-BAL-RB	1-1/2"	Phenolic	350	Roller	2.5
BH-4150-HT-RB	1-1/2"	Hi-Temp Phenolic	350	Roller	2.5
BH-4150-BST	1-1/2"	Cast Steel	350	Plain	4.5
BH-4150-BST-RB	1-1/2"	Cast Steel	350	Roller	4.5
BH-4150-UN-RB	1-1/2"	Star-Tech Urethane	350	Roller	2.5
BH-4150-UC-RB	1-1/2"	Urethane on Cast	350	Roller	3.5
BH-4150C-ES-HRB	1-1/2"	Solid Elastomer (Crowned)	350	HD Roller	2.5
BH-4150-MR-RB	1-1/2"	Multi-Purpose Rubber	350	Roller	3.0
BH-4150-EL-RB	1-1/2"	Eliminator Grey Rubber	350	Roller	2.5
BH-4150-RMC-RB	1-1/2"	Rubber Moldon (H90)	350	Roller	4.0
BH-4150-NL-RB	1-1/2"	Ny-Lite	350	Roller	2.5
BH-4150-NY-RB	1-1/2"	White Nylon	350	Roller	2.5
BH-4150-EAS-PBB	1-1/2"	Anti-Static Elastomer	350	Precision Ball	2.5
BH-100-HTM-HL	35mm	Hi-Temp Monolithic	275	Hi-Lex	2.5

BH SERIES BOLT HOLE CASTERS



Swivel Model Number	Tread Width	Wheel Type	Capacity (lbs.)	Bearing Type	Weight (Approx)
5" Diameter Wheels					
BH-5150-BAL-RB	1-1/2"	Phenolic	450	Roller	3.0
BH-5150-BST-RB	1-1/2"	Cast Steel	450	Roller	4.5
BH-5150-UN-RB	1-1/2"	Star-Tech Urethane	450	Roller	2.5
BH-5150-UC-RB	1-1/2"	Urethane on Cast	450	Roller	4.5
BH-5150C-ES-HRB	1-1/2"	Solid Elastomer (Crowned)	450	HD Roller	3.0
BH-5150-MR-RB	1-1/2"	Multi-Purpose Rubber	450	Roller	3.5
BH-5150-EL-RB	1-1/2"	Eliminator Grey Rubber	400	Roller	2.5
BH-5150-RMC-RB	1-1/2"	Rubber Moldon (H90)	450	Roller	4.5
BH-5150-NL-RB	1-1/2"	Ny-Lite	450	Roller	2.5
BH-5150-NY-RB	1-1/2"	White Nylon	450	Roller	3.0
BH-5150-EAS-PBB	1-1/2"	Anti-Static Elastomer	450	Precision Ball	3.0
BH-125-HTM-HL	40mm	Hi-Temp Monolithic	330	Hi-Lex	3.0
6" Diameter Wheels					
BH-6150-BAL-RB	1-1/2"	Phenolic	500	Roller	3.5
BH-6150-UN-RB	1-1/2"	Star-Tech Urethane	500	Roller	3.0
BH-6150-UC-RB	1-1/2"	Urethane on Cast	500	Roller	5.0
BH-6150-MR-RB	1-1/2"	Multi-Purpose Rubber	500	Roller	3.5
BH-6150-EL-RB	1-1/2"	Eliminator Grey Rubber	500	Roller	3.0
BH-6150-RMC-RB	1-1/2"	Rubber Moldon (H90)	500	Roller	5.0
BH-6150-NL-RB	1-1/2"	Ny-Lite	500	Roller	2.5
BH-6150-NY-RB	1-1/2"	White Nylon	500	Roller	3.0
Options: (1) For Total Lock Brake add code 'TLB' to model number (eg. BH/ <u>TLB</u> -5150-EL-RB) (2) Delrin Bearing. Substitute 'DEL' for 'RB' or 'BB' in Model Number (eg. BH-3150-BAL- <u>DEL</u>) (3) Custom stems available. Consult Factory					
Notes: Listed capacities are for casters only (without stems). Some stems may reduce the above listed capacities. Consult Factory.					

LB AND BH SERIES STANDARD STEMS

Stem Model Number	Stem Type	Stem Material	Stem Weight (Approx.)
LB OR BH STEM: 3/4" PT	PIPE THREAD STEM	ZINC PLATED	0.50
LB OR BH STEM: 7/16" X 1-3/8" SC	STEM & CIRCLIP	ZINC PLATED	0.25
LB OR BH STEM: 5/8" X 1-5/8" SC	STEM & CIRCLIP	ZINC PLATED	0.25
LB OR BH STEM: .845" X 2-1/2" SC	STEM & CIRCLIP	ZINC PLATED	0.75
LB OR BH STEM: 7/8" X 2" SC	STEM & CIRCLIP	ZINC PLATED	0.75
LB OR BH STEM: 3/4" X 2" SQ C/W THREE 1/4" DRIFT HOLES	SQUARE STEM	ZINC PLATED	0.50
LB OR BH STEM: 1/2"-13 X 1" TS C/W LOCKWASHER & NUT	THREADED STEM	STEEL	0.25
LB OR BH STEM: 5/8"-11 X 2" TS	THREADED STEM	STEEL	0.50
LB OR BH STEM: 3/4"-10 X 2-1/4" TS	THREADED STEM	STEEL	0.50
Notes: Specific stem selections may result in reduced overall caster capacities. Consult Factory. Stems are intended to mount the caster flush with the mounting surface and must not be used for load levelling purposes.			

CUSTOM STEMS? NO PROBLEM!

At Bestway Casters & Wheels we manufacture our own stems. Nothing is imported. This means that custom designs are no problem! If our standard stem models just won't do, tell us what you need and we'll make it for you. In-house machining means faster delivery and lower cost.

Here's just a sample of the types of custom stems we can manufacture for you:

- Steel, Zinc Plated or Stainless Steel Material
- Fully or Partially Threaded Stems
- Standard or Custom Threads and Pitches
- Virtually Any Length or Diameter of Material
- Round, Square, Hex or Channel Steel Stems
- Stem & Circlip (Grip Ring) Stems
- Cross Holes
- Custom Mounting Brackets (Gate Casters, etc.)

The RT Series uses the same high quality construction as our signature "Bestway" Series in a stem caster. Our wide selection of standard and custom stems mean that this caster can be mounted in virtually any application. Equipped with 5/8" kingpin construction, 1/4" leg material, zinc plated finish and a huge selection of wheel sizes. This is a truly exceptional product. North American made for fast delivery and competitive pricing and are fully customizable upon request.

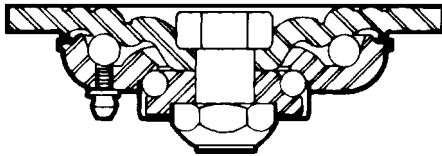

Cross-section illustrates the design of the generously proportioned upper and lower ball races, which ride on 5/16" and 1/4" diameter hardened ball bearings respectively.



RT-6200-ES-RB
C/W RT STEM: 3/4"-10 x 4" TS



GC-6200C-ES-PBB
(See Page 44)



RTR-5200-BAL-RB
C/W RT STEM: 3/4" x 4" PS

Wheel Diam.	OH	Swiv. Rad.
3	4-3/8"	2-3/4"
3-1/4**	4-1/2"	2-13/16"
4"	5-5/8"	3-13/16"
5"	6-1/2"	4-7/16"
6"	7-1/2"	4-9/16"
8"	9-1/2"	5-7/8"

See Page 29 For Standard Stem Options

Swivel Model Number	Rigid Model Number	Tread Width	Wheel Type	Capacity (lbs.)	Bearing Type	Weight (Approx) Swivel	Weight (Approx) Rigid
3" Diameter Wheels							
RT-3150-BAL-RB	RTR-3150-BAL-RB	1-1/2"	Phenolic	500	Roller	4.0	3.0
RT-3150-BST-RB	RTR-3150-BST-RB	1-1/2"	Cast Steel	500	Roller	5.5	4.5
RT-3150-UC-RB	RTR-3150-UC-RB	1-1/2"	Urethane on Cast	400	Roller	5.0	4.0
RT-3150C-ES-HRB	RTR-3150C-ES-HRB	1-1/2"	Solid Elastomer (Crowned)	350	HD Roller	4.0	3.0
RT-3150-RMC-RB	RTR-3150-RMC-RB	1-1/2"	Rubber Moldon (H90)	300	Roller	5.0	4.0
RT-3200-BAL-RB*	RTR-3200-BAL-RB*	2"	Phenolic	600	Roller	4.0	3.0
RT-3200-BST-RB	RTR-3200-BST-RB	2"	Cast Steel	600	Roller	6.5	5.5
RT-3200-UC-RB	RTR-3200-UC-RB	2"	Urethane on Cast	540	Roller	5.5	4.5
4" Diameter Wheels							
RT-4150-BAL-RB	RTR-4150-BAL-RB	1-1/2"	Phenolic	500	Roller	4.0	3.5
RT-4150-HT-RB	RTR-4150-HT-RB	1-1/2"	Hi-Temp Phenolic	400	Roller	4.0	3.5
RT-4150-BST	RTR-4150-BST	1-1/2"	Cast Steel	500	Plain	6.0	5.5
RT-4150-BST-RB	RTR-4150-BST-RB	1-1/2"	Cast Steel	500	Roller	6.0	5.5
RT-4150-UN-RB	RTR-4150-UN-RB	1-1/2"	Star-Tech Urethane	440	Roller	4.0	3.5
RT-4150-UC-RB	RTR-4150-UC-RB	1-1/2"	Urethane on Cast	500	Roller	5.0	4.5
RT-4150C-ES-HRB	RTR-4150C-ES-HRB	1-1/2"	Solid Elastomer (Crowned)	400	HD Roller	4.0	3.5
RT-4150-MR-RB	RTR-4150-MR-RB	1-1/2"	Multi-Purpose Rubber	400	Roller	4.5	4.0
RT-4150-EL-RB	RTR-4150-EL-RB	1-1/2"	Eliminator Grey Rubber	350	Roller	4.0	3.5
RT-4150-RMC-RB	RTR-4150-RMC-RB	1-1/2"	Rubber Moldon (H90)	500	Roller	5.5	5.0
RT-4150-NL-RB	RTR-4150-NL-RB	1-1/2"	Ny-Lite	420	Roller	4.0	3.5
RT-4200-BAL-RB	RTR-4200-BAL-RB	2"	Phenolic	600	Roller	4.5	4.0
RT-4200-HT-RB	RTR-4200-HT-RB	2"	Hi-Temp Phenolic	500	Roller	4.5	4.0
RT-4200-BST-RB	RTR-4200-BST-RB	2"	Cast Steel	600	Roller	6.5	6.0
RT-4200-UN-RB	RTR-4200-UN-RB	2"	Star-Tech Urethane	600	Roller	4.0	3.5
RT-4200-UC-RB	RTR-4200-UC-RB	2"	Urethane on Cast	600	Roller	6.0	5.5
RT-4200C-ES-HRB	RTR-4200C-ES-HRB	2"	Solid Elastomer (Crowned)	600	HD Roller	6.0	5.5
RT-4200-MR-RB	RTR-4200-MR-RB	2"	Multi-Purpose Rubber	450	Roller	5.0	4.5
RT-4200-EL-RB	RTR-4200-EL-RB	2"	Eliminator Grey Rubber	600	Roller	4.0	3.5
RT-4200-RMC-RB	RTR-4200-RMC-RB	2"	Rubber Moldon (H90)	600	Roller	6.0	5.5
RT-4200-NL-RB	RTR-4200-NL-RB	2"	Ny-Lite	500	Roller	4.0	3.5

Swivel Model Number	Rigid Model Number	Tread Width	Wheel Type	Capacity (lbs.)	Bearing Type	Weight (Approx)	
						Swivel	Rigid
5" Diameter Wheels							
RT-5150-BAL-RB	RTR-5150-BAL-RB	1-1/2"	Phenolic	500	Roller	4.5	4.0
RT-5150-BST-RB	RTR-5150-BST-RB	1-1/2"	Cast Steel	500	Roller	6.0	5.5
RT-5150-UN-RB	RTR-5150-UN-RB	1-1/2"	Star-Tech Urethane	500	Roller	4.0	3.5
RT-5150-UC-RB	RTR-5150-UC-RB	1-1/2"	Urethane on Cast	500	Roller	6.0	5.5
RT-5150C-ES-HRB	RTR-5150C-ES-HRB	1-1/2"	Solid Elastomer (Crowned)	500	HD Roller	4.5	4.0
RT-5150-MR-RB	RTR-5150-MR-RB	1-1/2"	Multi-Purpose Rubber	450	Roller	5.0	4.5
RT-5150-EL-RB	RTR-5150-EL-RB	1-1/2"	Eliminator Grey Rubber	400	Roller	4.0	3.5
RT-5150-RMC-RB	RTR-5150-RMC-RB	1-1/2"	Rubber Moldon (H90)	500	Roller	6.0	5.5
RT-5150-NL-RB	RTR-5150-NL-RB	1-1/2"	Ny-Lite	500	Roller	4.0	3.5
RT-5200-BAL-RB	RTR-5200-BAL-RB	2"	Phenolic	600	Roller	5.0	4.5
RT-5200-HT-RB	RTR-5200-HT-RB	2"	Hi-Temp Phenolic	600	Roller	5.0	4.5
RT-5200-BST-RB	RTR-5200-BST-RB	2"	Cast Steel	600	Roller	8.0	7.5
RT-5200-UN-RB	RTR-5200-UN-RB	2"	Star-Tech Urethane	600	Roller	4.5	4.0
RT-5200-UC-RB	RTR-5200-UC-RB	2"	Urethane on Cast	600	Roller	6.5	6.0
RT-5200C-ES-HRB	RTR-5200C-ES-HRB	2"	Solid Elastomer (Crowned)	600	HD Roller	4.5	4.0
RT-5200-MR-RB	RTR-5200-MR-RB	2"	Multi-Purpose Rubber	550	Roller	5.0	4.5
RT-5200-EL-RB	RTR-5200-EL-RB	2"	Eliminator Grey Rubber	600	Roller	4.5	4.0
RT-5200-RMC-RB	RTR-5200-RMC-RB	2"	Rubber Moldon (H90)	600	Roller	6.5	6.0
RT-5200-NL-RB	RTR-5200-NL-RB	2"	Ny-Lite	600	Roller	4.5	4.0
6" Diameter Wheels							
RT-6150-BAL-RB	RTR-6150-BAL-RB	1-1/2"	Phenolic	500	Roller	5.5	4.5
RT-6150-UN-RB	RTR-6150-UN-RB	1-1/2"	Star-Tech Urethane	500	Roller	5.0	4.0
RT-6150-UC-RB	RTR-6150-UC-RB	1-1/2"	Urethane on Cast	500	Roller	7.0	6.0
RT-6150-MR-RB	RTR-6150-MR-RB	1-1/2"	Multi-Purpose Rubber	500	Roller	5.5	4.5
RT-6150-EL-RB	RTR-6150-EL-RB	1-1/2"	Eliminator Grey Rubber	500	Roller	5.0	4.0
RT-6150-RMC-RB	RTR-6150-RMC-RB	1-1/2"	Rubber Moldon (H90)	500	Roller	7.0	6.0
RT-6150-NL-RB	RTR-6150-NL-RB	1-1/2"	Ny-Lite	500	Roller	4.5	3.5
RT-6200-BAL-RB	RTR-6200-BAL-RB	2"	Phenolic	600	Roller	6.5	5.5
RT-6200-HT-RB	RTR-6200-HT-RB	2"	Hi-Temp Phenolic	600	Roller	6.5	5.5
RT-6200-BST-RB	RTR-6200-BST-RB	2"	Cast Steel	600	Roller	9.0	8.0
RT-6200-UN-RB	RTR-6200-UN-RB	2"	Star-Tech Urethane	600	Roller	5.5	4.5
RT-6200-UC-RB	RTR-6200-UC-RB	2"	Urethane on Cast	600	Roller	8.0	7.0
RT-6200-ES-HRB	RTR-6200-ES-HRB	2"	Solid Elastomer	600	HD Roller	6.0	5.0
RT-6200-ES-PBB	RTR-6200-ES-PBB	2"	Solid Elastomer	600	Precision Ball	6.0	5.0
RT-6200C-ES-HRB	RTR-6200C-ES-HRB	2"	Solid Elastomer (Crowned)	600	HD Roller	6.0	5.0
RT-6200-MR-RB	RTR-6200-MR-RB	2"	Multi-Purpose Rubber	600	Roller	6.5	5.5
RT-6200-EL-RB	RTR-6200-EL-RB	2"	Eliminator Grey Rubber	600	Roller	5.5	4.5
RT-6200-RMC-RB	RTR-6200-RMC-RB	2"	Rubber Moldon (H90)	600	Roller	7.5	6.5
RT-6200C-RTC-RB	RTR-6200C-RTC-RB	2"	Grey Donut Rubber	420	Roller	8.0	7.0
RT-6200-NL-RB	RTR-6200-NL-RB	2"	Ny-Lite	600	Roller	5.0	4.0
8" Diameter Wheels							
RT-8200-BAL-RB	RTR-8200-BAL-RB	2"	Phenolic	700	Roller	7.5	7.0
RT-8200-HT-RB	RTR-8200-HT-RB	2"	Hi-Temp Phenolic	700	Roller	7.5	7.0
RT-8200-BST-RB	RTR-8200-BST-RB	2"	Cast Steel	700	Roller	12.5	12.0
RT-8200-UN-RB	RTR-8200-UN-RB	2"	Star-Tech Urethane	700	Roller	6.0	5.5
RT-8200-UC-RB	RTR-8200-UC-RB	2"	Urethane on Cast	700	Roller	10.5	10.0
RT-8200-ES-HRB	RTR-8200-ES-HRB	2"	Solid Elastomer	700	HD Roller	7.0	6.5
RT-8200-ES-PBB	RTR-8200-ES-PBB	2"	Solid Elastomer	700	Precision Ball	7.0	6.5
RT-8200C-ES-HRB	RTR-8200C-ES-HRB	2"	Solid Elastomer (Crowned)	700	HD Roller	8.5	8.0
RT-8200-MR-RB	RTR-8200-MR-RB	2"	Multi-Purpose Rubber	700	Roller	8.0	7.5
RT-8200-EL-RB	RTR-8200-EL-RB	2"	Eliminator Grey Rubber	700	Roller	6.0	5.5
RT-8200-RMC-RB	RTR-8200-RMC-RB	2"	Rubber Moldon (H90)	700	Roller	10.0	9.5
RT-8200C-RTC-RB	RTR-8200C-RTC-RB	2"	Grey Donut Rubber	500	Roller	10.0	9.5
RT-8200-NL-RB	RTR-8200-NL-RB	2"	Ny-Lite	700	Roller	5.5	5.0

- Options:** (1) Pedal Brake available on swivels and rigids. Add code 'BR' to model number (eg. RT/**BR**-8200-BST-RB)
 (2) Head Seals available on swivels only. Add code 'HS' to model number. (eg. RT/**HS**-4150-NL-RB)
 (3) Delrin Bearing. Substitute 'DEL' for 'RB' in Model Number (eg. RT-4200-MR-**DEL**)
 (4) Heavy Duty Roller Bearing. Substitute 'HRB' for 'RB' in Model Number (eg. RT-6200-BST-**HRB**)
 (5) Flanged Ball Bearing. Substitute 'BB' for 'RB' in Model Number (eg. RT-8200-UC-**BB**)
 (6) Flanged Brass Bearing. Substitute 'BF' for 'RB' in Model Number (eg. RT-6200-HT-**BF**)
 (7) Custom stems available. Consult Factory.

Notes: Listed capacities are for casters only (without stems). Some stems may reduce the above listed capacities. Consult Factory.

Stem Model Number	Stem Type	Stem Material	Stem Weight (Approx.)
RT STEM: 3/4" X 4" PS	PLAIN STEM	ZINC PLATED	0.75
RT STEM: 7/8" X 4" PS	PLAIN STEM	ZINC PLATED	1.00
RT STEM: 1" X 4" PS	PLAIN STEM	ZINC PLATED	1.25
RT STEM: 1-3/8" X 4" PS	PLAIN STEM	ZINC PLATED	2.50
RT STEM: .845" X 2-1/2" SC	STEM & CIRCLIP	ZINC PLATED	0.75
RT STEM: 7/8" X 2" SC	STEM & CIRCLIP	ZINC PLATED	0.75
RT STEM: 3/4"-10 X 2-1/4" TS	THREADED STEM	STEEL	0.50
RT STEM: 3/4"-10 X 4" TS	THREADED STEM	STEEL	0.75
RT STEM: 1"-8 X 4" TS	THREADED STEM	STEEL	1.25

Notes: Specific stem selections may result in reduced overall caster capacities. Consult Factory.
Stems are intended to mount the caster flush with the mounting surface and must not be used for load levelling purposes.

AND NOW FOR SOMETHING COMPLETELY DIFFERENT!

At Bestway the word "Custom" doesn't just mean simple modifications to existing caster designs. If you require a truly unique product for a truly unique application call us - we can make it for you.

Here's just a few of the custom designs we have developed in the past:



**Stainless Steel Kingboltless Caster
c/w Special Top Plate & Hi-Temp Nylon Wheel**



**"Mini-LD" 1-1/2" Face
Kingboltless Caster**



**SSRT Series Caster
c/w Swivel Lock**

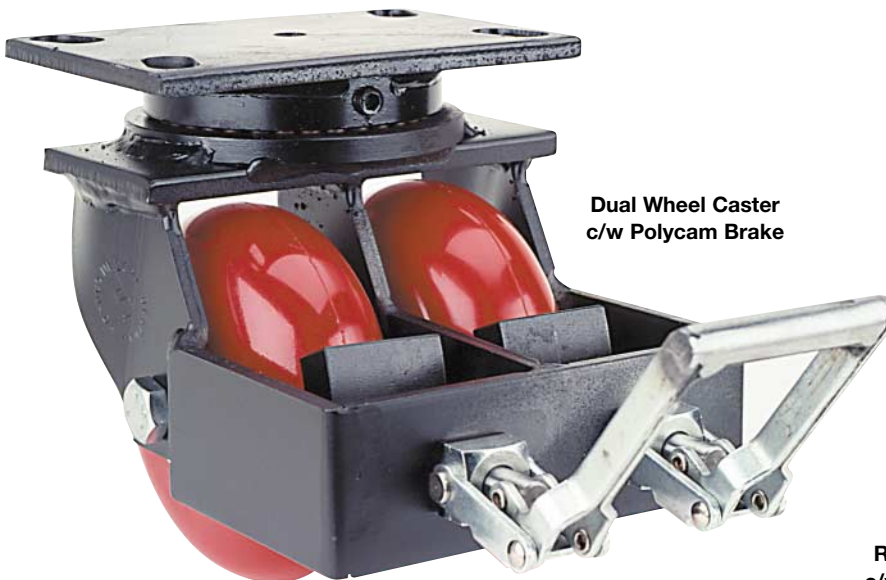

**Dual Wheel Caster
c/w Polycam Brake**



**RT Series Rigid Caster
c/w 3" x 3" Square Stem**

SSLP/SSLPR SERIES STAINLESS STEEL CASTERS

250 lbs. Maximum Capacity

Top Plate: 2-5/8" x 3-3/4" Mounting Holes: 1-3/4" x 2-7/8" Slotted to 1-3/4" x 3" BHS 5/16" Hole Clearance



SSLP/BR-4125-EL-DEL

This is a totally stainless steel version of our popular LP Series caster. Constructed in deep-dish double ball raceways, stainless balls, stainless axles, everything on this beauty is stainless! Industry standard top plate, excellent mobility and large wheel selection make this caster an excellent choice for all of your stainless applications. Ideal for hospital carts, cheese factories, slaughterhouses, poultry and fish plants where steam cleaning and cleanliness are a must. Head seals are standard.



SSLP-4150C-ES-DEL

Wheel Diam.	OH	Swiv. Rad.
3"	4"	3-1/8"
4"	5"	3-1/4"
5"	6"	4"

Swivel Model Number	Rigid Model Number	Tread Width	Wheel Type	Capacity (lbs.)	Bearing Type	Weight (Approx)	
						Swivel	Rigid
3" Diameter Wheels							
SSLP-3125-BAL	SSLPR-3125-BAL	1-1/4"	Phenolic	250	Plain	2.0	1.5
SSLP-3125-UN-DEL	SSLPR-3125-UN-DEL	1-1/4"	Star-Tech Urethane	250	Delrin	2.0	1.5
SSLP-3125-EL-DEL	SSLPR-3125-EL-DEL	1-1/4"	Eliminator Grey Rubber	200	Delrin	2.0	1.5
SSLP-3125-NL	SSLPR-3125-NL	1-1/4"	Ny-Lite	250	Plain	2.0	1.5
SSLP-3125-WNL	SSLPR-3125-WNL	1-1/4"	White Poly-Olefin	250	Plain	2.0	1.5
SSLP-3150C-ES-DEL	SSLPR-3150C-ES-DEL	1-1/2"	Solid Elastomer (Crowned)	250	Delrin	2.5	2.0
SSLP-3150-NY-DEL	SSLPR-3150-NY-DEL	1-1/2"	White Nylon	250	Delrin	2.5	2.0
SSLP-080-UNY-SSRB	SSLPR-080-UNY-SSRB	30mm	Urethane on Nylon	220	Stainless Roller	2.0	1.5
SSLP-080-HTM-HL	SSLPR-080-HTM-HL	35mm	Hi-Temp Monolithic	220	Hi-Lex	2.0	1.5
4" Diameter Wheels							
SSLP-4125-BAL	SSLPR-4125-BAL	1-1/4"	Phenolic	250	Plain	2.5	2.0
SSLP-4125-UN-DEL	SSLPR-4125-UN-DEL	1-1/4"	Star-Tech Urethane	250	Delrin	2.5	2.0
SSLP-4125-EL-DEL	SSLPR-4125-EL-DEL	1-1/4"	Eliminator Grey Rubber	220	Delrin	2.5	2.0
SSLP-4125-NL	SSLPR-4125-NL	1-1/4"	Ny-Lite	250	Plain	2.0	1.5
SSLP-4125-WNL	SSLPR-4125-WNL	1-1/4"	White Poly-Olefin	250	Plain	2.0	1.5
SSLP-4150-HT-SSRB	SSLPR-4150-HT-SSRB	1-1/2"	Hi-Temp Phenolic	250	Stainless Roller	2.5	2.0
SSLP-4150-UN-DEL	SSLPR-4150-UN-DEL	1-1/2"	Star-Tech Urethane	250	Delrin	2.5	2.0
SSLP-4150C-ES-DEL	SSLPR-4150C-ES-DEL	1-1/2"	Solid Elastomer (Crowned)	250	Delrin	2.5	2.0
SSLP-4150-EL-DEL	SSLPR-4150-EL-DEL	1-1/2"	Eliminator Grey Rubber	250	Delrin	2.5	2.0
SSLP-4150-NL-DEL	SSLPR-4150-NL-DEL	1-1/2"	Ny-Lite	250	Delrin	2.5	2.0
SSLP-4150-NY-DEL	SSLPR-4150-NY-DEL	1-1/2"	White Nylon	250	Delrin	2.5	2.0
SSLP-100-UNY-SSRB	SSLPR-100-UNY-SSRB	30mm	Urethane on Nylon	240	Stainless Roller	2.0	1.5
SSLP-100-HTM-HL	SSLPR-100-HTM-HL	35mm	Hi-Temp Monolithic	250	Hi-Lex	2.5	2.0
5" Diameter Wheels							
SSLP-5125-BAL	SSLPR-5125-BAL	1-1/4"	Phenolic	250	Plain	2.5	2.0
SSLP-5125-UN-DEL	SSLPR-5125-UN-DEL	1-1/4"	Star-Tech Urethane	250	Delrin	2.5	2.0
SSLP-5125-EL-DEL	SSLPR-5125-EL-DEL	1-1/4"	Eliminator Grey Rubber	250	Delrin	2.5	2.0
SSLP-5125-NL	SSLPR-5125-NL	1-1/4"	Ny-Lite	250	Plain	2.0	1.5
SSLP-5125-WNL	SSLPR-5125-WNL	1-1/4"	White Poly-Olefin	250	Plain	2.0	1.5
SSLP-5150-UN-DEL	SSLPR-5150-UN-DEL	1-1/2"	Star-Tech Urethane	250	Delrin	2.5	2.0
SSLP-5150C-ES-DEL	SSLPR-5150C-ES-DEL	1-1/2"	Solid Elastomer (Crowned)	250	Delrin	3.0	2.5
SSLP-5150-EL-DEL	SSLPR-5150-EL-DEL	1-1/2"	Eliminator Grey Rubber	250	Delrin	2.5	2.0
SSLP-5150-NL-DEL	SSLPR-5150-NL-DEL	1-1/2"	Ny-Lite	250	Delrin	2.5	2.0
SSLP-5150-NY-DEL	SSLPR-5150-NY-DEL	1-1/2"	White Nylon	250	Delrin	3.0	2.5

- Options:** (1) For Side Pedal Brake on swivels only. Add code 'BR' to model number (eg. SSLP/BR-5150-UN-DEL)
 (2) Brass Flanged Bearing. Substitute 'BF' for 'DEL' in Model Number (eg. SSLPR-3150-NY-BF)
 (3) Stainless Steel Roller Bearing. Substitute 'SSRB' for 'DEL' in Model Number (eg. SSLP-4150-NY-SSRB)

Notes: Due to the forming process, the overall top plate dimensions for rigid casters may be somewhat larger than the dimensions listed above.

230 lbs. Maximum Capacity

Bolt Hole Clearance: 1/2". Standard and Custom Stems Available (Consult Factory).

We've developed a fully stainless steel version of our hugely popular LB Series bolthole caster. This caster can be mounted using a nut & bolt or by a wide variety of standard or custom stainless steel stems available from our machine shop.



Wheel Diam.	OH	Swiv. Rad.
3"	4"	3-1/8"
4"	5"	3-1/4"
5"	6"	4"

See Below for Standard Stem Options

SSLB-5125-NY
C/W SSLP STEM: 3/4"-10 x 2" TS

Swivel Model Number	Tread Width	Wheel Type	Capacity (lbs.)	Bearing Type	Weight (Approx)
3" Diameter Wheels					
SSLB-3125-BAL	1-1/4"	Phenolic	230	Plain	1.5
SSLB-3125-UN-DEL	1-1/4"	Star-Tech Urethane	230	Delrin	1.5
SSLB-3125-EL-DEL	1-1/4"	Eliminator Grey Rubber	200	Delrin	1.5
SSLB-3125-NL	1-1/4"	Ny-Lite	230	Plain	1.5
SSLB-3125-WNL	1-1/4"	White Poly-Olefin	230	Plain	1.5
SSLB-3150C-ES-DEL	1-1/2"	Solid Elastomer (Crowned)	230	Delrin	2.0
SSLB-3150-NY-DEL	1-1/2"	White Nylon	230	Delrin	2.0
SSLB-080-UNY-SSRB	30mm	Urethane on Nylon	220	Stainless Roller	1.5
SSLB-080-HTM-HL	35mm	Hi-Temp Monolithic	220	Hi-Lex	1.5
4" Diameter Wheels					
SSLB-4125-BAL	1-1/4"	Phenolic	230	Plain	2.0
SSLB-4125-UN-DEL	1-1/4"	Star-Tech Urethane	230	Delrin	2.0
SSLB-4125-EL-DEL	1-1/4"	Eliminator Grey Rubber	220	Delrin	2.0
SSLB-4125-NL	1-1/4"	Ny-Lite	230	Plain	1.5
SSLB-4125-WNL	1-1/4"	White Poly-Olefin	230	Plain	1.5
SSLB-4150-HT-SSRB	1-1/2"	Hi-Temp Phenolic	230	Stainless Roller	2.0
SSLB-4150-UN-DEL	1-1/2"	Star-Tech Urethane	230	Delrin	2.0
SSLB-4150C-ES-DEL	1-1/2"	Solid Elastomer (Crowned)	230	Delrin	2.0
SSLB-4150-EL-DEL	1-1/2"	Eliminator Grey Rubber	230	Delrin	2.0
SSLB-4150-NL-DEL	1-1/2"	Ny-Lite	230	Delrin	2.0
SSLB-4150-NY-DEL	1-1/2"	White Nylon	230	Delrin	2.0
SSLB-100-UNY-SSRB	30mm	Urethane on Nylon	230	Stainless Roller	1.5
SSLB-100-HTM-HL	35mm	Hi-Temp Monolithic	230	Hi-Lex	2.0
5" Diameter Wheels					
SSLB-5125-BAL	1-1/4"	Phenolic	230	Plain	2.0
SSLB-5125-UN-DEL	1-1/4"	Star-Tech Urethane	230	Delrin	2.0
SSLB-5125-EL-DEL	1-1/4"	Eliminator Grey Rubber	230	Delrin	2.0
SSLB-5125-NL	1-1/4"	Ny-Lite	230	Plain	1.5
SSLB-5125-WNL	1-1/4"	White Poly-Olefin	230	Plain	1.5
SSLB-5150-UN-DEL	1-1/2"	Star-Tech Urethane	230	Delrin	2.0
SSLB-5150C-ES-DEL	1-1/2"	Solid Elastomer (Crowned)	230	Delrin	2.5
SSLB-5150-EL-DEL	1-1/2"	Eliminator Grey Rubber	230	Delrin	2.0
SSLB-5150-NL-DEL	1-1/2"	Ny-Lite	230	Delrin	2.0
SSLB-5150-NY-DEL	1-1/2"	White Nylon	230	Delrin	2.5

- Options:** (1) For Side Pedal Brake add code 'BR' to model number (eg. SSLB/**BR**-5150-UN-DEL)
 (2) Brass Flanged Bearing. Substitute 'BF' for 'DEL' in Model Number (eg. SSLB-3150-NY-**BF**)
 (3) Stainless Steel Roller Bearing. Substitute 'SSRB' for 'DEL' in Model Number (eg. SSLB-4150-NY-**SSRB**)
 (4) Custom stems available. Consult Factory.

Notes: Listed capacities are for casters only (without stems). Some stems may reduce the above listed capacities. Consult Factory.

SSLB SERIES STANDARD STEMS

Stem Model Number	Stem Type	Stem Material	Stem Weight (Approx.)
SSLB STEM: 7/16" X 1-3/8" SC	STEM & CIRCLIP	STAINLESS STEEL	0.25
SSLB STEM: 5/8" X 1-5/8" SC	STEM & CIRCLIP	STAINLESS STEEL	0.25
SSLB STEM: .845" X 2-1/2" SC	STEM & CIRCLIP	STAINLESS STEEL	0.75
SSLB STEM: 7/8" X 2" SC	STEM & CIRCLIP	STAINLESS STEEL	0.75
SSLB STEM: 3/4" X 2" SQ C/W THREE 1/4" DRIFT HOLES	SQUARE STEM	STAINLESS STEEL	0.50
SSLB STEM: 1/2"-13 X 1" TS C/W LOCKWASHER & NUT	THREADED STEM	STAINLESS STEEL	0.25
SSLB STEM: 5/8"-11 X 2" TS	THREADED STEM	STAINLESS STEEL	0.50
SSLB STEM: 3/4"-10 X 2" TS	THREADED STEM	STAINLESS STEEL	0.50

Notes: Specific stem selections may result in reduced overall caster capacities. Consult Factory.
 Stems are intended to mount the caster flush with the mounting surface and must not be used for load levelling purposes.

600 lbs. Maximum Capacity

Top Plate: 3-3/8" x 4-1/8" Mounting Holes: 2-1/8" x 2-7/16" Slotted to 2-5/8" x 3-3/8" BHS 5/16" Hole Clearance



SSGP/TLB-100-UNY-SSRB

This fully stainless steel version of our popular GP Series caster is truly an excellent product. No other medium duty stainless caster can compare. Excellent performance, great durability, and the same top quality "Total Lock Brake" as the standard GP Series make this an ideal caster for your steam cleaning and clean room applications. Double ball construction for maximum mobility, and a large wheel selection to suit any purpose.



SSGPR-4150-EL-DEL

NEW

Optional 4" x 4-1/2" Top Plate now available! (See below)

Wheel Diam.	OH	Swiv. Rad.
3"	4-1/16"	3"
4"	5-1/16"	3-1/2"
5"	6-1/8"	4-1/4"
6"	7-1/8"	4-3/4"

Swivel Model Number	Rigid Model Number	Tread Width	Wheel Type	Capacity (lbs.)	Bearing Type	Weight (Approx)	
						Swivel	Rigid
3" Diameter Wheels							
SSGP-3125-UN-DEL	SSGPR-3125-UN-DEL	1-1/4"	Star-Tech Urethane	250	Delrin	2.0	1.5
SSGP-3125-EL-DEL	SSGPR-3125-EL-DEL	1-1/4"	Eliminator Grey Rubber	200	Delrin	2.0	1.5
SSGP-3125-NL	SSGPR-3125-NL	1-1/4"	Ny-Lite	275	Plain	2.0	1.5
SSGP-3125-WNL	SSGPR-3125-WNL	1-1/4"	White Poly-Olefin	275	Plain	2.0	1.5
SSGP-3150-BAL-DEL	SSGPR-3150-BAL-DEL	1-1/2"	Phenolic	300	Delrin	2.5	2.0
SSGP-3150C-ES-DEL	SSGPR-3150C-ES-DEL	1-1/2"	Solid Elastomer (Crowned)	300	Delrin	2.5	2.0
SSGP-3150-NY-DEL	SSGPR-3150-NY-DEL	1-1/2"	White Nylon	300	Delrin	2.5	2.0
SSGP-080-UNY-SSRB	SSGPR-080-UNY-SSRB	30mm	Urethane on Nylon	220	Stainless Roller	2.0	1.5
SSGP-080-NY	SSGPR-080-NY	30mm	White Nylon	220	Plain	2.0	1.5
SSGP-080-HTM-HL	SSGPR-080-HTM-HL	35mm	Hi-Temp Monolithic	220	Hi-Lex	2.0	1.5
4" Diameter Wheels							
SSGP-4125-UN-DEL	SSGPR-4125-UN-DEL	1-1/4"	Star-Tech Urethane	250	Delrin	2.5	2.0
SSGP-4125-EL-DEL	SSGPR-4125-EL-DEL	1-1/4"	Eliminator Grey Rubber	220	Delrin	2.5	2.0
SSGP-4125-NL	SSGPR-4125-NL	1-1/4"	Ny-Lite	300	Plain	2.0	1.5
SSGP-4125-WNL	SSGPR-4125-WNL	1-1/4"	White Poly-Olefin	300	Plain	2.0	1.5
SSGP-4150-BAL-DEL	SSGPR-4150-BAL-DEL	1-1/2"	Phenolic	400	Delrin	2.5	2.0
SSGP-4150-HT-SSRB	SSGPR-4150-HT-SSRB	1-1/2"	Hi-Temp Phenolic	400	Stainless Roller	2.5	2.0
SSGP-4150-UN-DEL	SSGPR-4150-UN-DEL	1-1/2"	Star-Tech Urethane	400	Delrin	2.5	2.0
SSGP-4150C-ES-DEL	SSGPR-4150C-ES-DEL	1-1/2"	Solid Elastomer (Crowned)	400	Delrin	2.5	2.0
SSGP-4150-EL-DEL	SSGPR-4150-EL-DEL	1-1/2"	Eliminator Grey Rubber	350	Delrin	2.5	2.0
SSGP-4150-NL-DEL	SSGPR-4150-NL-DEL	1-1/2"	Ny-Lite	400	Delrin	2.5	2.0
SSGP-4150-NY-DEL	SSGPR-4150-NY-DEL	1-1/2"	White Nylon	400	Delrin	2.5	2.0
SSGP-100-UNY-SSRB	SSGPR-100-UNY-SSRB	30mm	Urethane on Nylon	240	Stainless Roller	2.0	1.5
SSGP-100-NY	SSGPR-100-NY	35mm	White Nylon	300	Plain	2.0	1.5
SSGP-100-HTM-HL	SSGPR-100-HTM-HL	35mm	Hi-Temp Monolithic	275	Hi-Lex	2.5	2.0
5" Diameter Wheels							
SSGP-5150-BAL-DEL	SSGPR-5150-BAL-DEL	1-1/2"	Phenolic	500	Delrin	3.0	2.5
SSGP-5150-UN-DEL	SSGPR-5150-UN-DEL	1-1/2"	Star-Tech Urethane	500	Delrin	2.5	2.0
SSGP-5150C-ES-DEL	SSGPR-5150C-ES-DEL	1-1/2"	Solid Elastomer (Crowned)	500	Delrin	3.0	2.5
SSGP-5150-EL-DEL	SSGPR-5150-EL-DEL	1-1/2"	Eliminator Grey Rubber	400	Delrin	2.5	2.0
SSGP-5150-NL-DEL	SSGPR-5150-NL-DEL	1-1/2"	Ny-Lite	500	Delrin	2.5	2.0
SSGP-5150-NY-DEL	SSGPR-5150-NY-DEL	1-1/2"	White Nylon	500	Delrin	3.0	2.5
SSGP-125-UNY-SSRB	SSGPR-125-UNY-SSRB	30mm	Urethane on Nylon	400	Stainless Roller	2.5	2.0
SSGP-125-NY	SSGPR-125-NY	40mm	White Nylon	350	Plain	2.5	2.0
SSGP-125-HTM-HL	SSGPR-125-HTM-HL	40mm	Hi-Temp Monolithic	330	Hi-Lex	3.0	2.5
6" Diameter Wheels							
SSGP-6150-BAL-DEL	SSGPR-6150-BAL-DEL	1-1/2"	Phenolic	600	Delrin	5.0	3.0
SSGP-6150-UN-DEL	SSGPR-6150-UN-DEL	1-1/2"	Star-Tech Urethane	600	Delrin	4.5	2.5
SSGP-6150-EL-DEL	SSGPR-6150-EL-DEL	1-1/2"	Eliminator Grey Rubber	500	Delrin	4.5	2.5
SSGP-6150-NL-DEL	SSGPR-6150-NL-DEL	1-1/2"	Ny-Lite	600	Delrin	4.0	2.0
SSGP-6150-NY-DEL	SSGPR-6150-NY-DEL	1-1/2"	White Nylon	600	Delrin	4.5	2.5

- Options:** (1) For Total Lock Brake on swivels only add code 'TLB' to model number (eg. SSGP/TLB-5150-UN-DEL)
 (2) Optional 4" x 4-1/2" top plate available. Add code 'STP' to model number. (eg. SSGP/STP-6150-BAL-DEL)
 (3) Brass Flanged Bearing. Substitute 'BF' for 'DEL' in Model Number (eg. SSGP-3150-NY-BF)
 (4) Stainless Steel Roller Bearing. Substitute 'SSRB' for 'DEL' in Model Number (eg. SSGP-4150-NY-SSRB)

500 lbs. Maximum Capacity

Bolt Hole Clearance: 12.2mm. Standard and Custom Stems Available (Consult Factory)

The SSBH Series combines the versatility of mounting options of a bolthole caster with the unbeatable environmental

resistance of a fully stainless steel caster. Mount this caster with a nut & bolt or with one of the many standard or custom stainless steel stems available from our machine shop. The optional "Total Lock Brake" locks both the wheel and swivel with one push of the pedal. With double ball raceway construction and all stainless steel components, this is an excellent medium duty caster.



Wheel Diam.	OH	Swiv. Rad.
3"	4"	3"
4"	4-15/16"	3-1/2"
5"	6"	4-1/4"
6"	7"	4-3/4"

See Below for Standard Stem Options

SSBH/TLB-100-NY

Swivel Model Number	Tread Width	Wheel Type	Capacity (lbs.)	Bearing Type	Weight (Approx)
3" Diameter Wheels					
SSBH-3125-UN-DEL	1-1/4"	Star-Tech Urethane	250	Delrin	1.5
SSBH-3125-EL-DEL	1-1/4"	Eliminator Grey Rubber	200	Delrin	1.5
SSBH-3125-NL	1-1/4"	Ny-Lite	275	Plain	1.5
SSBH-3125-WNL	1-1/4"	White Poly-Olefin	275	Plain	1.5
SSBH-3150-BAL-DEL	1-1/2"	Phenolic	300	Delrin	2.0
SSBH-3150C-ES-DEL	1-1/2"	Solid Elastomer (Crowned)	300	Delrin	2.0
SSBH-3150-NY-DEL	1-1/2"	White Nylon	300	Delrin	2.0
SSBH-080-UNY-SSRB	30mm	Urethane on Nylon	220	Stainless Roller	1.5
SSBH-080-NY	30mm	White Nylon	220	Plain	1.5
SSBH-080-HTM-HL	35mm	Hi-Temp Monolithic	220	Hi-Lex	1.5
4" Diameter Wheels					
SSBH-4125-UN-DEL	1-1/4"	Star-Tech Urethane	250	Delrin	2.0
SSBH-4125-EL-DEL	1-1/4"	Eliminator Grey Rubber	220	Delrin	2.0
SSBH-4125-NL	1-1/4"	Ny-Lite	300	Plain	1.5
SSBH-4125-WNL	1-1/4"	White Poly-Olefin	300	Plain	1.5
SSBH-4150-BAL-DEL	1-1/2"	Phenolic	350	Delrin	2.0
SSBH-4150-HT-SSRB	1-1/2"	Hi-Temp Phenolic	350	Stainless Roller	2.0
SSBH-4150-UN-DEL	1-1/2"	Star-Tech Urethane	350	Delrin	2.0
SSBH-4150C-ES-DEL	1-1/2"	Solid Elastomer (Crowned)	350	Delrin	2.0
SSBH-4150-EL-DEL	1-1/2"	Eliminator Grey Rubber	350	Delrin	2.0
SSBH-4150-NL-DEL	1-1/2"	Ny-Lite	350	Delrin	2.0
SSBH-4150-NY-DEL	1-1/2"	White Nylon	350	Delrin	2.0
SSBH-100-UNY-SSRB	30mm	Urethane on Nylon	240	Stainless Roller	1.5
SSBH-100-NY	35mm	White Nylon	300	Plain	1.5
SSBH-100-HTM-HL	35mm	Hi-Temp Monolithic	275	Hi-Lex	2.0
5" Diameter Wheels					
SSBH-5150-BAL-DEL	1-1/2"	Phenolic	450	Delrin	3.0
SSBH-5150-UN-DEL	1-1/2"	Star-Tech Urethane	450	Delrin	2.5
SSBH-5150C-ES-DEL	1-1/2"	Solid Elastomer (Crowned)	450	Delrin	3.0
SSBH-5150-EL-DEL	1-1/2"	Eliminator Grey Rubber	400	Delrin	2.5
SSBH-5150-NL-DEL	1-1/2"	Ny-Lite	450	Delrin	2.5
SSBH-5150-NY-DEL	1-1/2"	White Nylon	450	Delrin	3.0
SSBH-125-UNY-SSRB	30mm	Urethane on Nylon	400	Stainless Roller	2.5
SSBH-125-NY	40mm	White Nylon	350	Plain	2.5
SSBH-125-HTM-HL	40mm	Hi-Temp Monolithic	330	Hi-Lex	3.0
6" Diameter Wheels					
SSBH-6150-BAL-DEL	1-1/2"	Phenolic	500	Delrin	3.5
SSBH-6150-UN-DEL	1-1/2"	Star-Tech Urethane	500	Delrin	3.0
SSBH-6150-EL-DEL	1-1/2"	Eliminator Grey Rubber	500	Delrin	3.0
SSBH-6150-NL-DEL	1-1/2"	Ny-Lite	500	Delrin	2.5
SSBH-6150-NY-DEL	1-1/2"	White Nylon	500	Delrin	3.0

- Options:** (1) For Total Lock Brake add code 'TLB' to model number (eg. SSBH/TLB-5150-UN-DEL)
 (2) Brass Flanged Bearing. Substitute 'BF' for 'DEL' in Model Number (eg. SSBH-3150-NY-BF)
 (3) Stainless Steel Roller Bearing. Substitute 'SSRB' for 'DEL' in Model Number (eg. SSBH-4150-NY-SSRB)
 (4) Custom stems available. Consult Factory.

Notes: Listed capacities are for casters only (without stems). Some stems may reduce the above listed capacities. Consult Factory.

SSBH SERIES STANDARD STEMS

Stem Model Number	Stem Type	Stem Material	Stem Weight (Approx.)
SSBH STEM: 7/16" X 1-3/8" SC	STEM & CIRCLIP	STAINLESS STEEL	0.25
SSBH STEM: 5/8" X 1-5/8" SC	STEM & CIRCLIP	STAINLESS STEEL	0.25
SSBH STEM: .845" X 2-1/2" SC	STEM & CIRCLIP	STAINLESS STEEL	0.75
SSBH STEM: 7/8" X 2" SC	STEM & CIRCLIP	STAINLESS STEEL	0.75
SSBH STEM: 3/4" X 2" SQ C/W THREE 1/4" DRIFT HOLES	SQUARE STEM	STAINLESS STEEL	0.50
SSBH STEM: 1/2"-13 X 1" TS C/W LOCKWASHER & NUT	THREADED STEM	STAINLESS STEEL	0.25
SSBH STEM: 5/8"-11 X 2" TS	THREADED STEM	STAINLESS STEEL	0.50
SSBH STEM: 3/4"-10 X 2" TS	THREADED STEM	STAINLESS STEEL	0.50

Notes: Specific stem selections may result in reduced overall caster capacities. Consult Factory.
 Stems are intended to mount the caster flush with the mounting surface and must not be used for load levelling purposes.

SS/SSR SERIES STAINLESS STEEL CASTERS



1,000 lbs. Maximum Capacity

Top Plate: 4" x 4-1/2" Mounting Holes: 2-5/8" x 3-5/8" Slotted to 3" x 3" BHS 3/8" Hole Clearance



SS/BR-6200-NY-DEL

Compare our SS Series casters to the competition and you'll quickly see the difference. This caster uses the same top quality design that has made our signature "Bestway" Series an industry leader. Our superior 5/8" nut & bolt kingpin construction with precision double ball raceways prove much more durable than riveted models. Heavy 1/4" material is used throughout for maximum strength and longevity.



SSR-6200-UN-DEL

North American made for fast delivery and competitive pricing and are fully customizable upon request. A huge selection of wheel sizes, wheel types, standard options and bearing types mean that this caster can fill virtually any role you have for it. We carry a huge inventory of our stainless casters to ensure speedy delivery!



SSFL-4 (See Page 50)

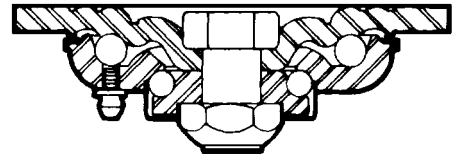

Cross-section illustrates the design of the generously proportioned upper and lower ball races, which ride on 5/16" and 1/4" diameter hardened ball bearings respectively.

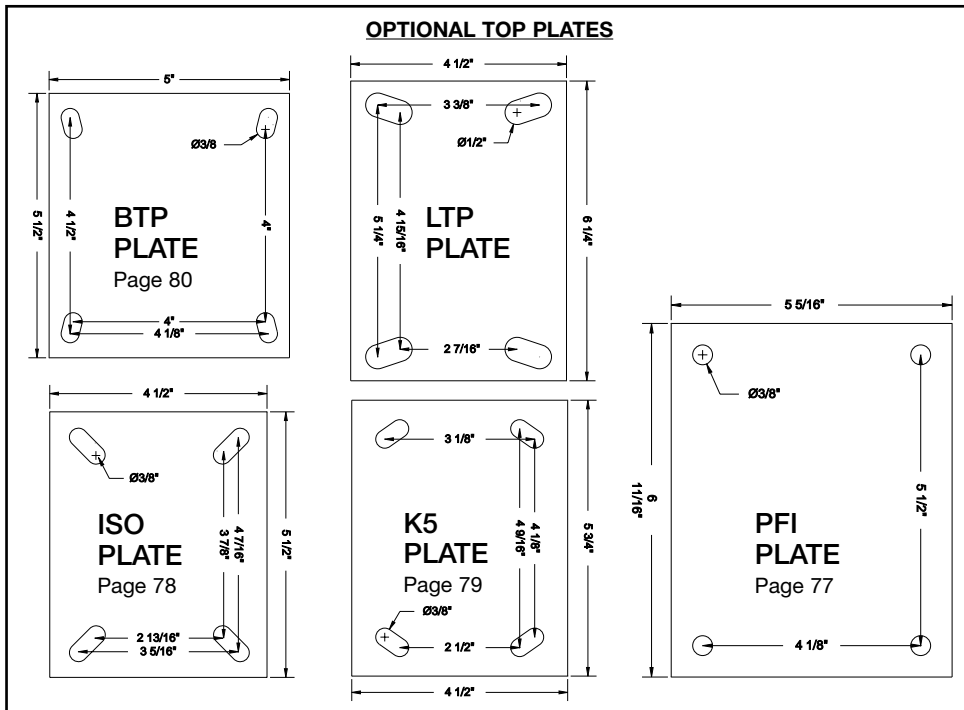

STANDARD TOP PLATE

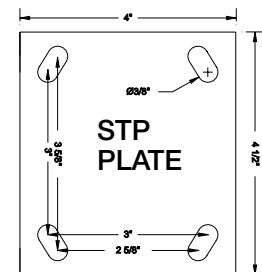

Wheel Diam.	OH	Swiv. Rad.
3"	4-3/8"	2-3/4"
3-1/4"*	4-1/2"	2-13/16"
4"	5-5/8"	3-13/16"
5"	6-1/2"	4-7/16"
6"	7-1/2"	4-9/16"
8"	9-1/2"	5-7/8"

Swivel Model Number	Rigid Model Number	Tread Width	Wheel Type	Capacity (lbs.)	Bearing Type	Weight (Approx) Swivel	Weight (Approx) Rigid
3" Diameter Wheels							
SS-3150-BAL-DEL	SSR-3150-BAL-DEL	1-1/2"	Phenolic	500	Delrin	4.5	3.5
SS-3150C-ES-DEL	SSR-3150C-ES-DEL	1-1/2"	Solid Elastomer (Crowned)	350	Delrin	4.5	3.5
SS-3150-NY-DEL	SSR-3150-NY-DEL	1-1/2"	White Nylon	500	Delrin	4.5	3.5
SS-3200-BAL-DEL*	SSR-3200-BAL-DEL*	2"	Phenolic	700	Delrin	4.5	3.5
SS-3200-NY-DEL	SSR-3200-NY-DEL	2"	White Nylon	700	Delrin	4.5	3.5
4" Diameter Wheels							
SS-4150-BAL-DEL	SSR-4150-BAL-DEL	1-1/2"	Phenolic	600	Delrin	4.5	3.5
SS-4150-HT-SSRB	SSR-4150-HT-SSRB	1-1/2"	Hi-Temp Phenolic	400	Stainless Roller	4.5	3.5
SS-4150-UN-DEL	SSR-4150-UN-DEL	1-1/2"	Star-Tech Urethane	440	Delrin	4.5	3.5
SS-4150C-ES-DEL	SSR-4150C-ES-DEL	1-1/2"	Solid Elastomer (Crowned)	400	Delrin	5.0	4.0
SS-4150-EL-DEL	SSR-4150-EL-DEL	1-1/2"	Eliminator Grey Rubber	350	Delrin	4.5	3.5
SS-4150-NL-DEL	SSR-4150-NL-DEL	1-1/2"	Ny-Lite	420	Delrin	4.5	3.5
SS-4150-NY-DEL	SSR-4150-NY-DEL	1-1/2"	White Nylon	600	Delrin	4.5	3.5

Swivel Model Number	Rigid Model Number	Tread Width	Wheel Type	Capacity (lbs.)	Bearing Type	Weight (Approx) Swivel	Weight (Approx) Rigid
4" Diameter Wheels							
SS-4200-BAL-DEL	SSR-4200-BAL-DEL	2"	Phenolic	800	Delrin	5.0	4.0
SS-4200-HT-SSRB	SSR-4200-HT-SSRB	2"	Hi-Temp Phenolic	500	Stainless Roller	5.0	4.0
SS-4200-SSMS-SSRB	SSR-4200-SSMS-SSRB	2"	Stainless Steel	900	Stainless Roller	12.5	11.5
SS-4200-UN-DEL	SSR-4200-UN-DEL	2"	Star-Tech Urethane	600	Delrin	4.5	3.5
SS-4200C-UBA-PBB	SSR-4200C-UBA-PBB	2"	Urethane on Alum. (Crowned)	900	Precision Ball	5.5	4.5
SS-4200C-MBA-PBB	SSR-4200C-MBA-PBB	2"	Megabest (Crowned)	300	Precision Ball	5.5	4.5
SS-4200C-ES-DEL	SSR-4200C-ES-DEL	2"	Solid Elastomer (Crowned)	800	Delrin	5.0	4.0
SS-4200-EL-DEL	SSR-4200-EL-DEL	2"	Eliminator Grey Rubber	600	Delrin	4.5	3.5
SS-4200-NL-DEL	SSR-4200-NL-DEL	2"	Ny-Lite	500	Delrin	4.5	3.5
SS-4200-NY-DEL	SSR-4200-NY-DEL	2"	White Nylon	800	Delrin	5.0	4.0
5" Diameter Wheels							
SS-5150-BAL-DEL	SSR-5150-BAL-DEL	1-1/2"	Phenolic	600	Delrin	5.5	4.0
SS-5150-UN-DEL	SSR-5150-UN-DEL	1-1/2"	Star-Tech Urethane	500	Delrin	5.0	3.5
SS-5150C-ES-DEL	SSR-5150C-ES-DEL	1-1/2"	Solid Elastomer (Crowned)	500	Delrin	5.5	4.0
SS-5150-EL-DEL	SSR-5150-EL-DEL	1-1/2"	Eliminator Grey Rubber	400	Delrin	5.0	3.5
SS-5150-NL-DEL	SSR-5150-NL-DEL	1-1/2"	Ny-Lite	550	Delrin	5.0	3.5
SS-5150-NY-DEL	SSR-5150-NY-DEL	1-1/2"	White Nylon	600	Delrin	5.5	4.0
SS-5200-BAL-DEL	SSR-5200-BAL-DEL	2"	Phenolic	900	Delrin	6.0	4.5
SS-5200-HT-SSRB	SSR-5200-HT-SSRB	2"	Hi-Temp Phenolic	750	Stainless Roller	6.0	4.5
SS-5200-UN-DEL	SSR-5200-UN-DEL	2"	Star-Tech Urethane	750	Delrin	5.5	4.0
SS-5200C-UBA-PBB	SSR-5200C-UBA-PBB	2"	Urethane on Alum. (Crowned)	900	Precision Ball	6.0	4.5
SS-5200C-MBA-PBB	SSR-5200C-MBA-PBB	2"	Megabest (Crowned)	300	Precision Ball	6.0	4.5
SS-5200C-ES-DEL	SSR-5200C-ES-DEL	2"	Solid Elastomer (Crowned)	900	Delrin	5.5	4.0
SS-5200-EL-DEL	SSR-5200-EL-DEL	2"	Eliminator Grey Rubber	700	Delrin	5.5	4.0
SS-5200-NL-DEL	SSR-5200-NL-DEL	2"	Ny-Lite	650	Delrin	5.5	4.0
SS-5200-NY-DEL	SSR-5200-NY-DEL	2"	White Nylon	900	Delrin	5.5	4.0
6" Diameter Wheels							
SS-6150-BAL-DEL	SSR-6150-BAL-DEL	1-1/2"	Phenolic	700	Delrin	6.0	5.0
SS-6150-UN-DEL	SSR-6150-UN-DEL	1-1/2"	Star-Tech Urethane	600	Delrin	5.5	4.5
SS-6150-EL-DEL	SSR-6150-EL-DEL	1-1/2"	Eliminator Grey Rubber	500	Delrin	5.5	4.5
SS-6150-NL-DEL	SSR-6150-NL-DEL	1-1/2"	Ny-Lite	600	Delrin	5.0	4.0
SS-6150-NY-DEL	SSR-6150-NY-DEL	1-1/2"	White Nylon	700	Delrin	5.5	4.5
SS-6200-BAL-DEL	SSR-6200-BAL-DEL	2"	Phenolic	900	Delrin	7.0	6.0
SS-6200-HT-SSRB	SSR-6200-HT-SSRB	2"	Hi-Temp Phenolic	900	Stainless Roller	7.0	6.0
SS-6200-SSMS-SSRB	SSR-6200-SSMS-SSRB	2"	Stainless Steel	900	Stainless Roller	24.0	23.0
SS-6200-UN-DEL	SSR-6200-UN-DEL	2"	Star-Tech Urethane	900	Delrin	6.0	5.0
SS-6200C-UBA-PBB	SSR-6200C-UBA-PBB	2"	Urethane on Alum. (Crowned)	900	Precision Ball	7.0	6.0
SS-6200C-MBA-PBB	SSR-6200C-MBA-PBB	2"	Megabest (Crowned)	400	Precision Ball	7.0	6.0
SS-6200-ES-DEL	SSR-6200-ES-DEL	2"	Solid Elastomer	900	Delrin	6.5	5.5
SS-6200C-ES-DEL	SSR-6200C-ES-DEL	2"	Solid Elastomer (Crowned)	900	Delrin	6.5	5.5
SS-6200C-EG-PBB	SSR-6200C-EG-PBB	2"	Elastiglide (Crowned)	900	Precision Ball	7.0	6.0
SS-6200-EL-DEL	SSR-6200-EL-DEL	2"	Eliminator Grey Rubber	900	Delrin	6.0	5.0
SS-6200-NL-DEL	SSR-6200-NL-DEL	2"	Ny-Lite	800	Delrin	5.5	4.5
SS-6200-NY-DEL	SSR-6200-NY-DEL	2"	White Nylon	900	Delrin	6.0	5.0
8" Diameter Wheels							
SS-8200-BAL-DEL	SSR-8200-BAL-DEL	2"	Phenolic	950	Delrin	8.0	7.0
SS-8200-HT-SSRB	SSR-8200-HT-SSRB	2"	Hi-Temp Phenolic	1000	Stainless Roller	8.0	7.0
SS-8200-UN-DEL	SSR-8200-UN-DEL	2"	Star-Tech Urethane	950	Delrin	6.5	5.5
SS-8200C-UBA-PBB	SSR-8200C-UBA-PBB	2"	Urethane on Alum. (Crowned)	1000	Precision Ball	9.0	8.0
SS-8200C-MBA-PBB	SSR-8200C-MBA-PBB	2"	Megabest (Crowned)	500	Precision Ball	9.5	8.5
SS-8200-ES-DEL	SSR-8200-ES-DEL	2"	Solid Elastomer	950	Delrin	7.5	6.5
SS-8200C-ES-DEL	SSR-8200C-ES-DEL	2"	Solid Elastomer (Crowned)	950	Delrin	9.0	8.0
SS-8200C-EG-PBB	SSR-8200C-EG-PBB	2"	Elastiglide (Crowned)	1000	Precision Ball	9.5	8.5
SS-8200-EL-DEL	SSR-8200-EL-DEL	2"	Eliminator Grey Rubber	900	Delrin	6.5	5.5
SS-8200-NL-DEL	SSR-8200-NL-DEL	2"	Ny-Lite	950	Delrin	6.0	5.0
SS-8200-NY-DEL	SSR-8200-NY-DEL	2"	White Nylon	950	Delrin	7.0	6.0

- Options:** (1) Pedal Brake available on swivels and rigids. Add code 'BR' to model number (eg. SS/**BR**-8200-BAL-DEL)
(2) Four Position Swivel Lock. Add code '4SL' to model number (eg. SS/**4SL**-5200-EL-DEL). Special order with ISO, K5 and PFI Plates.
(3) Optional Top Plates available. Add code LTP, BTP, ISO, K5 or PFI to model number. (eg. SSR/**LTP**-5200-BAL-DEL)
(4) Flanged Brass Bearing. Substitute 'BF' for 'DEL' in Model Number (eg. SS-6200-NY-**BF**)
(5) Stainless Steel Roller Bearing. Substitute 'SSRB' for 'DEL' in Model Number (eg. SS-6200-NY-**SSRB**)
(6) Stainless Steel Precision Ball Bearing. Substitute 'SSPBB' for 'PBB' in Model Number (eg. SS-8200C-EG-**SSPBB**)

700 lbs. Maximum Capacity

Mounting: Standard and Custom Stems Available (Consult Factory)



SSRT/BR-5200-EL-DEL
C/W SSRT STEM 1" x 4" PS

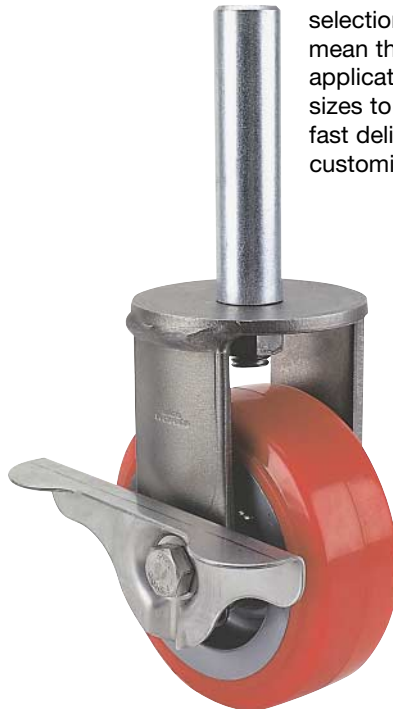

SSRTR/BR-5200-UN-DEL
C/W SSRT STEM 1" x 4" PS

This unique caster offers both the top quality construction and performance of our SS Series with the versatility of a stem caster. Equipped with 5/8" kingpin construction, heavy 1/4" leg material and all stainless steel material, this is an exceptional product. Our wide selection of standard and custom stainless steel stems mean that this caster can be mounted in virtually any application. We offer a large variety of wheel types and sizes to suit your many needs. North American made for fast delivery and competitive pricing and are fully customizable upon request.

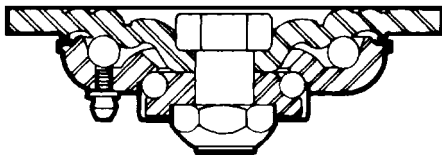

Cross-section illustrates the design of the generously proportioned upper and lower ball races, which ride on 5/16" and 1/4" diameter stainless steel ball bearings respectively.

Wheel Diam.	OH	Swiv. Rad.
3"	4-3/8"	2-3/4"
3-1/4"*	4-1/2"	2-13/16"
4"	5-5/8"	3-13/16"
5"	6-1/2"	4-7/16"
6"	7-1/2"	4-9/16"
8"	9-1/2"	5-7/8"

See Page 37 for Standard Stem Options

Swivel Model Number	Rigid Model Number	Tread Width	Wheel Type	Capacity (lbs.)	Bearing Type	Weight (Approx)	
						Swivel	Rigid
3" Diameter Wheels							
SSRT-3150-BAL-DEL	SSRTR-3150-BAL-DEL	1-1/2"	Phenolic	500	Delrin	4.0	3.0
SSRT-3150C-ES-DEL	SSRTR-3150C-ES-DEL	1-1/2"	Solid Elastomer (Crowned)	350	Delrin	4.0	3.0
SSRT-3150-NY-DEL	SSRTR-3150-NY-DEL	1-1/2"	White Nylon	500	Delrin	4.0	3.0
SSRT-3200-BAL-DEL*	SSRTR-3200-BAL-DEL*	2"	Phenolic	600	Delrin	4.0	3.0
SSRT-3200-NY-DEL	SSRTR-3200-NY-DEL	2"	White Nylon	600	Delrin	4.0	3.0
4" Diameter Wheels							
SSRT-4150-BAL-DEL	SSRTR-4150-BAL-DEL	1-1/2"	Phenolic	500	Delrin	4.0	3.5
SSRT-4150-HT-SSRB	SSRTR-4150-HT-SSRB	1-1/2"	Hi-Temp Phenolic	400	Stainless Roller	4.0	3.5
SSRT-4150-UN-DEL	SSRTR-4150-UN-DEL	1-1/2"	Star-Tech Urethane	440	Delrin	4.0	3.5
SSRT-4150C-ES-DEL	SSRTR-4150C-ES-DEL	1-1/2"	Solid Elastomer (Crowned)	400	Delrin	4.5	4.0
SSRT-4150-EL-DEL	SSRTR-4150-EL-DEL	1-1/2"	Eliminator Grey Rubber	350	Delrin	4.0	3.5
SSRT-4150-NL-DEL	SSRTR-4150-NL-DEL	1-1/2"	Ny-Lite	420	Delrin	4.0	3.5
SSRT-4150-NY-DEL	SSRTR-4150-NY-DEL	1-1/2"	White Nylon	500	Delrin	4.0	3.5
SSRT-4200-BAL-DEL	SSRTR-4200-BAL-DEL	2"	Phenolic	600	Delrin	4.5	4.0
SSRT-4200-HT-SSRB	SSRTR-4200-HT-SSRB	2"	Hi-Temp Phenolic	500	Stainless Roller	4.5	4.0
SSRT-4200-SSMS-SSRB	SSRTR-4200-SSMS-SSRB	2"	Stainless Steel	600	Stainless Roller	12.0	11.5
SSRT-4200-UN-DEL	SSRTR-4200-UN-DEL	2"	Star-Tech Urethane	600	Delrin	4.0	3.5
SSRT-4200C-UBA-PBB	SSRTR-4200C-UBA-PBB	2"	Urethane on Alum. (Crowned)	600	Precision Ball	5.0	4.5
SSRT-4200C-MBA-PBB	SSRTR-4200C-MBA-PBB	2"	Megabest (Crowned)	300	Precision Ball	5.0	4.5
SSRT-4200C-ES-DEL	SSRTR-4200C-ES-DEL	2"	Solid Elastomer (Crowned)	600	Delrin	4.5	4.0
SSRT-4200-EL-DEL	SSRTR-4200-EL-DEL	2"	Eliminator Grey Rubber	600	Delrin	4.0	3.5
SSRT-4200-NL-DEL	SSRTR-4200-NL-DEL	2"	Ny-Lite	500	Delrin	4.0	3.5
SSRT-4200-NY-DEL	SSRTR-4200-NY-DEL	2"	White Nylon	600	Delrin	4.5	4.0

Swivel Model Number	Rigid Model Number	Tread Width	Wheel Type	Capacity (lbs.)	Bearing Type	Weight (Approx) Swivel	Weight (Approx) Rigid
5" Diameter Wheels							
SSRT-5150-BAL-DEL	SSRTR-5150-BAL-DEL	1-1/2"	Phenolic	500	Delrin	5.0	4.0
SSRT-5150-UN-DEL	SSRTR-5150-UN-DEL	1-1/2"	Star-Tech Urethane	500	Delrin	4.5	3.5
SSRT-5150C-ES-DEL	SSRTR-5150C-ES-DEL	1-1/2"	Solid Elastomer (Crowned)	500	Delrin	5.0	4.0
SSRT-5150-EL-DEL	SSRTR-5150-EL-DEL	1-1/2"	Eliminator Grey Rubber	400	Delrin	4.5	3.5
SSRT-5150-NL-DEL	SSRTR-5150-NL-DEL	1-1/2"	Ny-Lite	500	Delrin	4.5	3.5
SSRT-5150-NY-DEL	SSRTR-5150-NY-DEL	1-1/2"	White Nylon	500	Delrin	5.0	4.0
SSRT-5200-BAL-DEL	SSRTR-5200-BAL-DEL	2"	Phenolic	600	Delrin	5.5	4.5
SSRT-5200-HT-SSRB	SSRTR-5200-HT-SSRB	2"	Hi-Temp Phenolic	600	Stainless Roller	5.5	4.5
SSRT-5200-UN-DEL	SSRTR-5200-UN-DEL	2"	Star-Tech Urethane	600	Delrin	5.0	4.0
SSRT-5200C-UBA-PBB	SSRTR-5200C-UBA-PBB	2"	Urethane on Alum. (Crowned)	600	Precision Ball	5.5	4.5
SSRT-5200C-MBA-PBB	SSRTR-5200C-MBA-PBB	2"	Megabest (Crowned)	300	Precision Ball	5.5	4.5
SSRT-5200C-ES-DEL	SSRTR-5200C-ES-DEL	2"	Solid Elastomer (Crowned)	600	Delrin	5.0	4.0
SSRT-5200-EL-DEL	SSRTR-5200-EL-DEL	2"	Eliminator Grey Rubber	600	Delrin	5.0	4.0
SSRT-5200-NL-DEL	SSRTR-5200-NL-DEL	2"	Ny-Lite	600	Delrin	5.0	4.0
SSRT-5200-NY-DEL	SSRTR-5200-NY-DEL	2"	White Nylon	600	Delrin	5.0	4.0
6" Diameter Wheels							
SSRT-6150-BAL-DEL	SSRTR-6150-BAL-DEL	1-1/2"	Phenolic	600	Delrin	5.5	4.5
SSRT-6150-UN-DEL	SSRTR-6150-UN-DEL	1-1/2"	Star-Tech Urethane	600	Delrin	5.0	4.0
SSRT-6150-EL-DEL	SSRTR-6150-EL-DEL	1-1/2"	Eliminator Grey Rubber	500	Delrin	5.0	4.0
SSRT-6150-NL-DEL	SSRTR-6150-NL-DEL	1-1/2"	Ny-Lite	600	Delrin	4.5	3.5
SSRT-6150-NY-DEL	SSRTR-6150-NY-DEL	1-1/2"	White Nylon	600	Delrin	5.0	4.0
SSRT-6200-BAL-DEL	SSRTR-6200-BAL-DEL	2"	Phenolic	600	Delrin	6.5	5.5
SSRT-6200-HT-SSRB	SSRTR-6200-HT-SSRB	2"	Hi-Temp Phenolic	600	Stainless Roller	6.5	5.5
SSRT-6200-SSMS-SSRB	SSRTR-6200-SSMS-SSRB	2"	Stainless Steel	600	Stainless Roller	23.5	22.5
SSRT-6200-UN-DEL	SSRTR-6200-UN-DEL	2"	Star-Tech Urethane	600	Delrin	5.5	4.5
SSRT-6200C-UBA-PBB	SSRTR-6200C-UBA-PBB	2"	Urethane on Alum. (Crowned)	600	Precision Ball	6.5	5.5
SSRT-6200C-MBA-PBB	SSRTR-6200C-MBA-PBB	2"	Megabest (Crowned)	400	Precision Ball	6.5	5.5
SSRT-6200-ES-DEL	SSRTR-6200-ES-DEL	2"	Solid Elastomer	600	Delrin	6.0	5.0
SSRT-6200C-ES-DEL	SSRTR-6200C-ES-DEL	2"	Solid Elastomer (Crowned)	600	Delrin	6.0	5.0
SSRT-6200C-EG-PBB	SSRTR-6200C-EG-PBB	2"	Elastiglide (Crowned)	600	Precision Ball	6.5	5.5
SSRT-6200-EL-DEL	SSRTR-6200-EL-DEL	2"	Eliminator Grey Rubber	600	Delrin	5.5	4.5
SSRT-6200-NL-DEL	SSRTR-6200-NL-DEL	2"	Ny-Lite	600	Delrin	5.0	4.0
SSRT-6200-NY-DEL	SSRTR-6200-NY-DEL	2"	White Nylon	600	Delrin	5.5	4.5
8" Diameter Wheels							
SSRT-8200-BAL-DEL	SSRTR-8200-BAL-DEL	2"	Phenolic	700	Delrin	7.5	7.0
SSRT-8200-HT-SSRB	SSRTR-8200-HT-SSRB	2"	Hi-Temp Phenolic	700	Stainless Roller	7.5	7.0
SSRT-8200-UN-DEL	SSRTR-8200-UN-DEL	2"	Star-Tech Urethane	700	Delrin	6.0	5.5
SSRT-8200C-UBA-PBB	SSRTR-8200C-UBA-PBB	2"	Urethane on Alum. (Crowned)	700	Precision Ball	8.5	8.0
SSRT-8200C-MBA-PBB	SSRTR-8200C-MBA-PBB	2"	Megabest (Crowned)	500	Precision Ball	9.0	8.5
SSRT-8200-ES-DEL	SSRTR-8200-ES-DEL	2"	Solid Elastomer	700	Delrin	7.0	6.5
SSRT-8200C-ES-DEL	SSRTR-8200C-ES-DEL	2"	Solid Elastomer (Crowned)	700	Delrin	8.5	8.0
SSRT-8200C-EG-PBB	SSRTR-8200C-EG-PBB	2"	Elastiglide (Crowned)	700	Precision Ball	9.0	8.5
SSRT-8200-EL-DEL	SSRTR-8200-EL-DEL	2"	Eliminator Grey Rubber	700	Delrin	6.0	5.5
SSRT-8200-NL-DEL	SSRTR-8200-NL-DEL	2"	Ny-Lite	700	Delrin	5.5	5.0
SSRT-8200-NY-DEL	SSRTR-8200-NY-DEL	2"	White Nylon	700	Delrin	6.5	6.0

- Options:** (1) Pedal Brake available on swivels and rigids. Add code 'BR' to model number (eg. SSRT/BR-8200-BAL-DEL)
 (2) Flanged Brass Bearing. Substitute 'BF' for 'DEL' in Model Number (eg. SSRT-6200-NY-BF)
 (3) Stainless Steel Roller Bearing. Substitute 'SSRB' for 'DEL' in Model Number (eg. SSRT-6200-NY-SSRB)
 (4) Stainless Steel Precision Ball Bearing. Substitute 'SSPBB' for 'PBB' in Model Number (eg. SSRT-8200C-EG-SSPBB)
 (5) Custom stems available. Consult Factory.

Notes: Listed capacities are for casters only (without stems). Some stems may reduce the above listed capacities. Consult Factory.

SSRT/SSRTR SERIES STANDARD STEMS

Stem Model Number	Stem Type	Stem Material	Stem Weight (Approx.)
SSRT STEM: 3/4" X 4" PS	PLAIN STEM	STAINLESS STEEL	0.75
SSRT STEM: 7/8" X 4" PS	PLAIN STEM	STAINLESS STEEL	1.00
SSRT STEM: 1" X 4" PS	PLAIN STEM	STAINLESS STEEL	1.25
SSRT STEM: 1-3/8" X 4" PS	PLAIN STEM	STAINLESS STEEL	2.50
SSRT STEM: .845" X 2-1/2" SC	STEM & CIRCLIP	STAINLESS STEEL	0.75
SSRT STEM: 7/8" X 2" SC	STEM & CIRCLIP	STAINLESS STEEL	0.75
SSRT STEM: 3/4"-10 X 2" TS	THREADED STEM	STAINLESS STEEL	0.50
SSRT STEM: 3/4"-10 X 4" TS	THREADED STEM	STAINLESS STEEL	0.75
SSRT STEM: 1"-8 X 4" TS	THREADED STEM	STAINLESS STEEL	1.25

- Notes:** Specific stem selections may result in reduced overall caster capacities. Consult Factory.
 Stems are intended to mount the caster flush with the mounting surface and must not be used for load levelling purposes.

SSLD/SSLDR SERIES STAINLESS STEEL CASTERS



1500 lbs. Maximum Capacity

Top Plate: 4" x 4-1/2" Mounting Holes: 2-5/8" x 3-5/8" Slotted to 3" x 3" BHS 3/8" Hole Clearance



SSLD/4SL-6200-SSMS-SSRB

Looking for the strength and durability of a Kingboltless caster in a stainless steel product? Look no further. Bestway now offers a fully stainless steel version of our revolutionary LD Series PATENTED Double Ball Kingboltless caster. With higher capacities and greater durability than traditional kingpin models (see page 15 for full details about our breakthrough design), these casters can withstand punishing topline and shockload applications. They are also ideal for applications that require a corrosive resistant, steam cleanable caster. North American made for fast delivery and competitive pricing and are fully customizable upon request.



SSFL-4 (See Page 50)

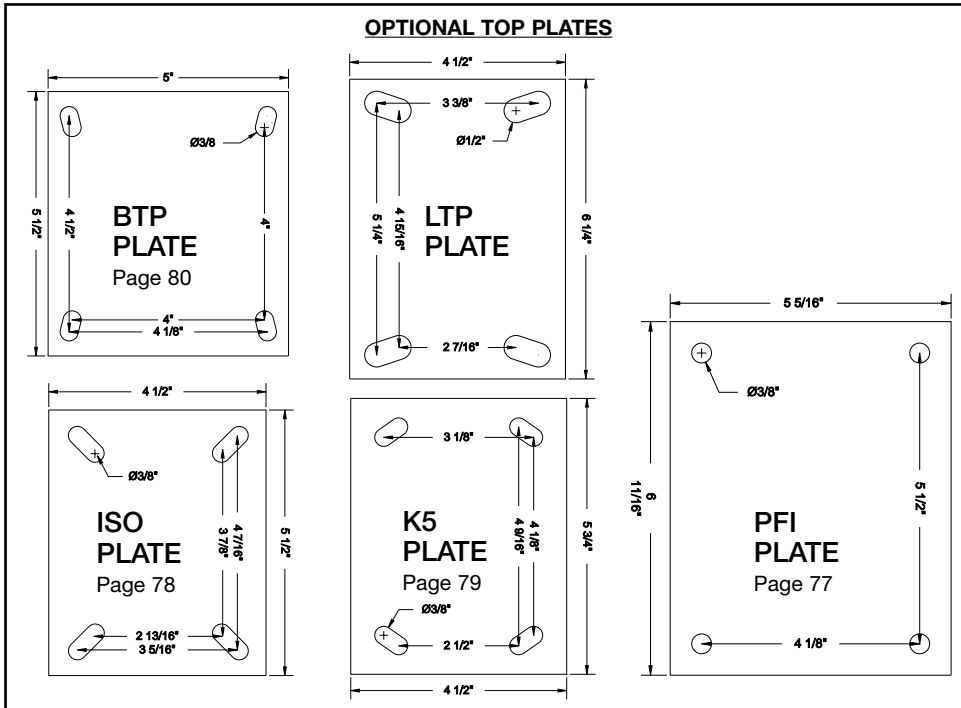

STANDARD TOP PLATE

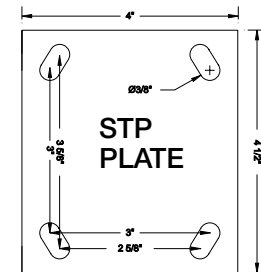

Wheel Diam.	OH	Swiv. Rad.
3"	4-1/2"	2-1/2"
3-1/4"*	4-5/8"	2-9/16"
4"	5-5/8"	2-11/16"
5"	6-1/2"	3-1/2"
6"	7-1/2"	4-1/4"
8"	9-1/2"	6-1/2"

US Patent #: 5,983,451

Canadian Patent #: 2,179,802

Swivel Model Number	Rigid Model Number	Tread Width	Wheel Type	Capacity (lbs.)	Bearing Type	Weight (Approx)	
						Swivel	Rigid
3" Diameter Wheels							
SSLD-3200-BAL-DEL*	SSLDR-3200-BAL-DEL*	2"	Phenolic	700	Delrin	6.0	3.5
SSLD-3200-NY-DEL	SSLDR-3200-NY-DEL	2"	White Nylon	800	Delrin	6.0	3.5
4" Diameter Wheels							
SSLD-4200-BAL-DEL	SSLDR-4200-BAL-DEL	2"	Phenolic	800	Delrin	6.5	4.0
SSLD-4200-LAM-DEL	SSLDR-4200-LAM-DEL	2"	Laminated Phenolic	950†	Delrin	6.5	4.0
SSLD-4200-HT-SSRB	SSLDR-4200-HT-SSRB	2"	Hi-Temp Phenolic	500	Stainless Roller	6.5	4.0
SSLD-4200-SSMS-SSRB	SSLDR-4200-SSMS-SSRB	2"	Stainless Steel	1500	Stainless Roller	14.0	11.5
SSLD-4200-UN-DEL	SSLDR-4200-UN-DEL	2"	Star-Tech Urethane	600	Delrin	6.0	3.5
SSLD-4200C-UBA-PBB	SSLDR-4200C-UBA-PBB	2"	Urethane on Alum. (Crowned)	900	Precision Ball	7.0	4.5
SSLD-4200C-MBA-PBB	SSLDR-4200C-MBA-PBB	2"	Megabest (Crowned)	300	Precision Ball	7.0	4.5
SSLD-4200C-ES-DEL	SSLDR-4200C-ES-DEL	2"	Solid Elastomer (Crowned)	800	Delrin	6.5	4.0
SSLD-4200C-ES-PBB	SSLDR-4200C-ES-PBB	2"	Solid Elastomer (Crowned)	800	Precision Ball	6.5	4.0
SSLD-4200-EL-DEL	SSLDR-4200-EL-DEL	2"	Eliminator Grey Rubber	600	Delrin	6.0	3.5
SSLD-4200-NY-DEL	SSLDR-4200-NY-DEL	2"	White Nylon	800	Delrin	6.5	4.0

Swivel Model Number	Rigid Model Number	Tread Width	Wheel Type	Capacity (lbs.)	Bearing Type	Weight (Approx)	
						Swivel	Rigid
5" Diameter Wheels							
SSLD-5200-BAL-DEL	SSLDR-5200-BAL-DEL	2"	Phenolic	950 [†]	Delrin	7.0	4.5
SSLD-5200-LAM-DEL	SSLDR-5200-LAM-DEL	2"	Laminated Phenolic	950 [†]	Delrin	7.0	4.5
SSLD-5200-HT-SSRB	SSLDR-5200-HT-SSRB	2"	Hi-Temp Phenolic	750	Stainless Roller	7.0	4.5
SSLD-5200-UN-DEL	SSLDR-5200-UN-DEL	2"	Star-Tech Urethane	750	Delrin	6.5	4.0
SSLD-5200C-UBA-PBB	SSLDR-5200C-UBA-PBB	2"	Urethane on Alum. (Crowned)	900	Precision Ball	7.0	4.5
SSLD-5200C-MBA-PBB	SSLDR-5200C-MBA-PBB	2"	Megabest (Crowned)	300	Precision Ball	7.0	4.5
SSLD-5200C-ES-DEL	SSLDR-5200C-ES-DEL	2"	Solid Elastomer (Crowned)	950 [†]	Delrin	6.5	4.0
SSLD-5200C-ES-PBB	SSLDR-5200C-ES-PBB	2"	Solid Elastomer (Crowned)	1000	Precision Ball	6.5	4.0
SSLD-5200-EL-DEL	SSLDR-5200-EL-DEL	2"	Eliminator Grey Rubber	700	Delrin	6.5	4.0
SSLD-5200-NY-DEL	SSLDR-5200-NY-DEL	2"	White Nylon	950 [†]	Delrin	6.5	4.0
6" Diameter Wheels							
SSLD-6200-BAL-DEL	SSLDR-6200-BAL-DEL	2"	Phenolic	950 [†]	Delrin	8.5	6.0
SSLD-6200-LAM-DEL	SSLDR-6200-LAM-DEL	2"	Laminated Phenolic	950 [†]	Delrin	8.5	6.0
SSLD-6200-HT-SSRB	SSLDR-6200-HT-SSRB	2"	Hi-Temp Phenolic	900	Stainless Roller	8.5	6.0
SSLD-6200-SSMS-SSRB	SSLDR-6200-SSMS-SSRB	2"	Stainless Steel	1500	Stainless Roller	25.5	23.0
SSLD-6200-UN-DEL	SSLDR-6200-UN-DEL	2"	Star-Tech Urethane	900	Delrin	7.5	5.0
SSLD-6200C-UBA-PBB	SSLDR-6200C-UBA-PBB	2"	Urethane on Alum. (Crowned)	1200	Precision Ball	8.5	6.0
SSLD-6200C-MBA-PBB	SSLDR-6200C-MBA-PBB	2"	Megabest (Crowned)	400	Precision Ball	8.5	6.0
SSLD-6200C-ES-DEL	SSLDR-6200C-ES-DEL	2"	Solid Elastomer (Crowned)	950 [†]	Delrin	8.0	5.5
SSLD-6200C-ES-PBB	SSLDR-6200C-ES-PBB	2"	Solid Elastomer (Crowned)	1200	Precision Ball	8.0	5.5
SSLD-6200C-EG-PBB	SSLDR-6200C-EG-PBB	2"	Elastiglide (Crowned)	1200	Precision Ball	8.5	6.0
SSLD-6200-EL-DEL	SSLDR-6200-EL-DEL	2"	Eliminator Grey Rubber	900	Delrin	7.5	5.0
SSLD-6200-NY-DEL	SSLDR-6200-NY-DEL	2"	White Nylon	950 [†]	Delrin	7.5	5.0
8" Diameter Wheels							
SSLD-8200-BAL-DEL	SSLDR-8200-BAL-DEL	2"	Phenolic	950 [†]	Delrin	9.5	7.0
SSLD-8200-LAM-DEL	SSLDR-8200-LAM-DEL	2"	Laminated Phenolic	950 [†]	Delrin	9.5	7.0
SSLD-8200-HT-SSRB	SSLDR-8200-HT-SSRB	2"	Hi-Temp Phenolic	1100	Stainless Roller	9.5	7.0
SSLD-8200-UN-DEL	SSLDR-8200-UN-DEL	2"	Star-Tech Urethane	950 [†]	Delrin	8.0	5.5
SSLD-8200C-UBA-PBB	SSLDR-8200C-UBA-PBB	2"	Urethane on Alum. (Crowned)	1500	Precision Ball	10.5	8.0
SSLD-8200C-MBA-PBB	SSLDR-8200C-MBA-PBB	2"	Megabest (Crowned)	500	Precision Ball	11.0	8.5
SSLD-8200C-ES-DEL	SSLDR-8200C-ES-DEL	2"	Solid Elastomer (Crowned)	950 [†]	Delrin	10.5	8.0
SSLD-8200C-ES-PBB	SSLDR-8200C-ES-PBB	2"	Solid Elastomer (Crowned)	1500	Precision Ball	10.5	8.0
SSLD-8200C-EG-PBB	SSLDR-8200C-EG-PBB	2"	Elastiglide (Crowned)	1500	Precision Ball	11.0	8.5
SSLD-8200-EL-DEL	SSLDR-8200-EL-DEL	2"	Eliminator Grey Rubber	900	Delrin	8.0	5.5
SSLD-8200-NY-DEL	SSLDR-8200-NY-DEL	2"	White Nylon	950 [†]	Delrin	8.5	6.0

- Options:** (1) Pedal Brake available on swivels and rigids. Add code 'BR' to model number (eg. SSLD/BR-8200-BAL-DEL)
(2) Four Position Swivel Lock. Add code '4SL' to model number (eg. SSLD/4SL-5200-EL-DEL). Special option for ISO, K5 and PFI Plates.
(3) Optional Top Plates available. Add code LTP, BTP, ISO, K5 or PFI to model number. (eg. SSLDR/LTP-5200-BAL-DEL)
(4) Flanged Brass Bearing. Substitute 'BF' for 'DEL' in Model Number (eg. SSLD-6200-NY-BF)
(5) Stainless Steel Roller Bearing. Substitute 'SSRB' for 'DEL' in Model Number (eg. SSLD-6200-NY-SSRB)
(6) Stainless Steel Precision Ball Bearing. Substitute 'SSPBB' for 'PBB' in Model Number (eg. SSLD-8200C-EG-SSPBB)
- Note:** † Higher capacities can be achieved using these wheels by substituting alternate bearing types.

THE BESTWAY STAINLESS ADVANTAGE

When it comes to Stainless Steel Casters nobody does it better than Bestway.

Once again we have shown why we continue to be the industry leader in Stainless Steel Casters with the introduction of our new SSLD, SSLE and SSLS Series Casters using our PATENTED Double Ball Kingboltless technology. Now the same Kingboltless design which has revolutionized the industrial caster market is available in a fully stainless steel version! Now there's a stainless steel caster that can withstand those punishing high-capacity, towline and shockload applications. And like all of our Kingboltless casters they can be fully customized to suite your specific needs.

Our ever popular SS and SSHD Series nut & bolt kingpin casters continue to top the list for quality, reliability and durability in the stainless market. We offer excellent North American quality, speedy delivery and a huge range of casters to suit almost any stainless application.

When it comes to stainless bolthole and stem casters, nobody compares to Bestway. From the light duty SSLB Series to our SSBH with its outstanding "Total Lock Brake", or the high-capacity SSRT workhorse - we have the caster for you! With virtually any custom stem available from our manufacturing facility make us your first choice for stainless stem casters.

For those lighter capacity applications don't forget our SSLP and SSGP Series top plate mounting casters. Value and Quality combined in a beautiful, fully stainless caster.

SSHD/SSHDR SERIES STAINLESS STEEL CASTERS

1200 lbs. Maximum Capacity

Top Plate: 4-1/2" x 6-1/4" Mounting Holes: 2-7/16" x 4-15/16" Slotted to 3-3/8" x 5-1/4" BHS 1/2" Hole Clearance



SSHD-4200-LAM-DEL

This is an even heavier duty version of our popular SS Series casters. It's improved features include; a high-capacity 3/4" nut & bolt kingpin, larger upper and lower ball raceways featuring 3/8" and 5/16" diameter ball bearings respectively, a larger (4-1/2" x 6-1/4") industry standard top plate, and reinforced legs on both swivels and rigids. Of course everything is 100% stainless steel. This product is ideal for those applications where a higher capacity stainless caster is required. North American made for fast delivery and competitive pricing and are fully customizable upon request.



SSHFL-4 (See Page 50)

Wheel Diam.	OH	Swiv. Rad.
4"	5-5/8"	3-5/16"
5"	6-1/2"	3-3/4"
6"	7-1/2"	4-5/8"
8"	New! 9-1/2"	6-3/8"

Swivel Model Number	Rigid Model Number	Tread Width	Wheel Type	Capacity (lbs.)	Bearing Type	Weight (Approx)	
						Swivel	Rigid
4" Diameter Wheels							
SSHD-4200-BAL-DEL	SSHDR-4200-BAL-DEL	2"	Phenolic	800	Delrin	6.5	4.5
SSHD-4200-LAM-DEL	SSHDR-4200-LAM-DEL	2"	Laminated Phenolic	950 [†]	Delrin	6.5	4.5
SSHD-4200-HT-SSRB	SSHDR-4200-HT-SSRB	2"	Hi-Temp Phenolic	500	Stainless Roller	6.5	4.5
SSHD-4200-SSMS-SSRB	SSHDR-4200-SSMS-SSRB	2"	Stainless Steel	1000	Stainless Roller	14.0	12.0
SSHD-4200-UN-DEL	SSHDR-4200-UN-DEL	2"	Star-Tech Urethane	600	Delrin	6.0	4.0
SSHD-4200C-ES-DEL	SSHDR-4200C-ES-DEL	2"	Solid Elastomer (Crowned)	800	Delrin	6.5	4.5
SSHD-4200-EL-DEL	SSHDR-4200-EL-DEL	2"	Eliminator Grey Rubber	600	Delrin	6.0	4.0
SSHD-4200-NL-DEL	SSHDR-4200-NL-DEL	2"	Ny-Lite	500	Delrin	6.0	4.0
SSHD-4200-NY-DEL	SSHDR-4200-NY-DEL	2"	White Nylon	800	Delrin	6.5	4.5
5" Diameter Wheels							
SSHD-5200-BAL-DEL	SSHDR-5200-BAL-DEL	2"	Phenolic	950 [†]	Delrin	7.0	5.5
SSHD-5200-LAM-DEL	SSHDR-5200-LAM-DEL	2"	Laminated Phenolic	950 [†]	Delrin	7.0	5.5
SSHD-5200-HT-SSRB	SSHDR-5200-HT-SSRB	2"	Hi-Temp Phenolic	750	Stainless Roller	7.0	5.5
SSHD-5200-UN-DEL	SSHDR-5200-UN-DEL	2"	Star-Tech Urethane	750	Delrin	6.5	5.0
SSHD-5200C-ES-DEL	SSHDR-5200C-ES-DEL	2"	Solid Elastomer (Crowned)	950 [†]	Delrin	6.5	5.0
SSHD-5200-EL-DEL	SSHDR-5200-EL-DEL	2"	Eliminator Grey Rubber	700	Delrin	6.5	5.0
SSHD-5200-NL-DEL	SSHDR-5200-NL-DEL	2"	Ny-Lite	650	Delrin	6.5	5.0
SSHD-5200-NY-DEL	SSHDR-5200-NY-DEL	2"	White Nylon	950 [†]	Delrin	6.5	5.0
6" Diameter Wheels							
SSHD-6200-BAL-DEL	SSHDR-6200-BAL-DEL	2"	Phenolic	950 [†]	Delrin	8.5	6.5
SSHD-6200-LAM-DEL	SSHDR-6200-LAM-DEL	2"	Laminated Phenolic	950 [†]	Delrin	8.5	6.5
SSHD-6200-HT-SSRB	SSHDR-6200-HT-SSRB	2"	Hi-Temp Phenolic	900	Stainless Roller	8.5	6.5
SSHD-6200-SSMS-SSRB	SSHDR-6200-SSMS-SSRB	2"	Stainless Steel	1200	Stainless Roller	25.5	23.5
SSHD-6200-UN-DEL	SSHDR-6200-UN-DEL	2"	Star-Tech Urethane	900	Delrin	7.5	5.5
SSHD-6200-ES-DEL	SSHDR-6200-ES-DEL	2"	Solid Elastomer	950 [†]	Delrin	8.0	6.0
SSHD-6200C-ES-DEL	SSHDR-6200C-ES-DEL	2"	Solid Elastomer (Crowned)	950 [†]	Delrin	8.0	6.0
SSHD-6200-EL-DEL	SSHDR-6200-EL-DEL	2"	Eliminator Grey Rubber	900	Delrin	7.5	5.5
SSHD-6200-NL-DEL	SSHDR-6200-NL-DEL	2"	Ny-Lite	800	Delrin	7.0	5.0
SSHD-6200-NY-DEL	SSHDR-6200-NY-DEL	2"	White Nylon	950 [†]	Delrin	7.5	5.5
8" Diameter Wheels							
SSHD-8200-BAL-DEL	SSHDR-8200-BAL-DEL	2"	Phenolic	950 [†]	Delrin	10.0	8.0
SSHD-8200-LAM-DEL	SSHDR-8200-LAM-DEL	2"	Laminated Phenolic	950 [†]	Delrin	10.0	8.0
SSHD-8200-HT-SSRB	SSHDR-8200-HT-SSRB	2"	Hi-Temp Phenolic	1100	Stainless Roller	10.0	8.0
SSHD-8200-UN-DEL	SSHDR-8200-UN-DEL	2"	Star-Tech Urethane	950 [†]	Delrin	8.5	6.5
SSHD-8200-ES-DEL	SSHDR-8200-ES-DEL	2"	Solid Elastomer	950 [†]	Delrin	9.5	7.5
SSHD-8200C-ES-DEL	SSHDR-8200C-ES-DEL	2"	Solid Elastomer (Crowned)	950 [†]	Delrin	11.0	9.0
SSHD-8200-EL-DEL	SSHDR-8200-EL-DEL	2"	Eliminator Grey Rubber	900	Delrin	8.5	6.5
SSHD-8200-NL-DEL	SSHDR-8200-NL-DEL	2"	Ny-Lite	950 [†]	Delrin	8.0	6.0
SSHD-8200-NY-DEL	SSHDR-8200-NY-DEL	2"	White Nylon	950 [†]	Delrin	9.0	7.0

- Options:** (1) Pedal Brake available on swivels and rigids. Add code 'BR' to model number (eg. SSHD/BR-8200-BAL-DEL)
 (2) Four Position Swivel Lock. Add code '4SL' to model number (eg. SSHD/4SL-5200-EL-DEL)
 (3) Flanged Brass Bearing. Substitute 'BF' for 'DEL' in Model Number (eg. SSHD-6200-NY-BF)
 (4) Stainless Steel Roller Bearing. Substitute 'SSRB' for 'DEL' in Model Number (eg. SSHD-6200-NY-SSRB)

Note: † Higher capacities can be achieved using these wheels by substituting alternate bearing types.

A fully stainless steel version of our LE Series PATENTED Double Ball Kingboltless caster. The same features as our regular LE Series make this the best stainless steel caster available for a 2" face wheel. Unmatched strength and durability, North American quality, and large wheel selection make this the choice for those high-performance applications that require a corrosive resistant, steam cleanable caster. And since there is no kingpin to bend or break, this caster is ideal for towline and shockload applications.

Wheel Diam.	OH	Swiv. Rad.
4"	5-5/8"	3-3/8"
5"	6-1/2"	4"
6"	7-1/2"	4-3/8"
8"	New 9-1/2"	5-11/16"

US Patent #: 5,983,451

Canadian Patent #: 2,179,802



SSLE-6200C-ES-PBB

Swivel Model Number	Rigid Model Number	Tread Width	Wheel Type	Capacity (lbs.)	Bearing Type	Weight (Approx)	
						Swivel	Rigid
4" Diameter Wheels							
SSLE-4200-BAL-DEL	SSLER-4200-BAL-DEL	2"	Phenolic	800	Delrin	9.5	5.5
SSLE-4200-LAM-DEL	SSLER-4200-LAM-DEL	2"	Laminated Phenolic	950 [†]	Delrin	9.5	5.5
SSLE-4200-HT-SSRB	SSLER-4200-HT-SSRB	2"	Hi-Temp Phenolic	500	Stainless Roller	9.5	5.5
SSLE-4200-SSMS-SSRB	SSLER-4200-SSMS-SSRB	2"	Stainless Steel	1500	Stainless Roller	17.0	13.0
SSLE-4200-UN-DEL	SSLER-4200-UN-DEL	2"	Star-Tech Urethane	600	Delrin	9.0	5.0
SSLE-4200C-UBA-PBB	SSLER-4200C-UBA-PBB	2"	Urethane on Alum. (Crowned)	900	Precision Ball	10.0	6.0
SSLE-4200C-MBA-PBB	SSLER-4200C-MBA-PBB	2"	Megabest (Crowned)	300	Precision Ball	10.0	6.0
SSLE-4200C-ES-DEL	SSLER-4200C-ES-DEL	2"	Solid Elastomer (Crowned)	800	Delrin	9.5	5.5
SSLE-4200C-ES-PBB	SSLER-4200C-ES-PBB	2"	Solid Elastomer (Crowned)	800	Precision Ball	9.5	5.5
SSLE-4200-EL-DEL	SSLER-4200-EL-DEL	2"	Eliminator Grey Rubber	600	Delrin	9.0	5.0
SSLE-4200-NY-DEL	SSLER-4200-NY-DEL	2"	White Nylon	800	Delrin	9.5	5.5
5" Diameter Wheels							
SSLE-5200-BAL-DEL	SSLER-5200-BAL-DEL	2"	Phenolic	950 [†]	Delrin	10.0	6.0
SSLE-5200-LAM-DEL	SSLER-5200-LAM-DEL	2"	Laminated Phenolic	950 [†]	Delrin	10.0	6.0
SSLE-5200-HT-SSRB	SSLER-5200-HT-SSRB	2"	Hi-Temp Phenolic	750	Stainless Roller	10.0	6.0
SSLE-5200-UN-DEL	SSLER-5200-UN-DEL	2"	Star-Tech Urethane	750	Delrin	9.5	5.5
SSLE-5200C-UBA-PBB	SSLER-5200C-UBA-PBB	2"	Urethane on Alum. (Crowned)	900	Precision Ball	10.0	6.0
SSLE-5200C-MBA-PBB	SSLER-5200C-MBA-PBB	2"	Megabest (Crowned)	300	Precision Ball	10.0	6.0
SSLE-5200C-ES-DEL	SSLER-5200C-ES-DEL	2"	Solid Elastomer (Crowned)	950 [†]	Delrin	9.5	5.5
SSLE-5200C-ES-PBB	SSLER-5200C-ES-PBB	2"	Solid Elastomer (Crowned)	1000	Precision Ball	9.5	5.5
SSLE-5200-EL-DEL	SSLER-5200-EL-DEL	2"	Eliminator Grey Rubber	700	Delrin	9.5	5.5
SSLE-5200-NY-DEL	SSLER-5200-NY-DEL	2"	White Nylon	950 [†]	Delrin	9.5	5.5
6" Diameter Wheels							
SSLE-6200-BAL-DEL	SSLER-6200-BAL-DEL	2"	Phenolic	950 [†]	Delrin	11.5	7.5
SSLE-6200-LAM-DEL	SSLER-6200-LAM-DEL	2"	Laminated Phenolic	950 [†]	Delrin	11.5	7.5
SSLE-6200-HT-SSRB	SSLER-6200-HT-SSRB	2"	Hi-Temp Phenolic	900	Stainless Roller	11.5	7.5
SSLE-6200-SSMS-SSRB	SSLER-6200-SSMS-SSRB	2"	Stainless Steel	1800	Stainless Roller	28.5	24.5
SSLE-6200-UN-DEL	SSLER-6200-UN-DEL	2"	Star-Tech Urethane	900	Delrin	10.5	6.5
SSLE-6200C-UBA-PBB	SSLER-6200C-UBA-PBB	2"	Urethane on Alum. (Crowned)	1200	Precision Ball	11.5	7.5
SSLE-6200C-MBA-PBB	SSLER-6200C-MBA-PBB	2"	Megabest (Crowned)	400	Precision Ball	11.5	7.5
SSLE-6200C-ES-DEL	SSLER-6200C-ES-DEL	2"	Solid Elastomer (Crowned)	950 [†]	Delrin	11.0	7.0
SSLE-6200C-ES-PBB	SSLER-6200C-ES-PBB	2"	Solid Elastomer (Crowned)	1200	Precision Ball	11.0	7.0
SSLE-6200C-EG-PBB	SSLER-6200C-EG-PBB	2"	Elastiglide (Crowned)	1200	Precision Ball	11.5	7.5
SSLE-6200-EL-DEL	SSLER-6200-EL-DEL	2"	Eliminator Grey Rubber	900	Delrin	10.5	6.5
SSLE-6200-NY-DEL	SSLER-6200-NY-DEL	2"	White Nylon	950 [†]	Delrin	10.5	6.5
8" Diameter Wheels							
SSLE-8200-BAL-DEL	SSLER-8200-BAL-DEL	2"	Phenolic	950 [†]	Delrin	13.0	9.0
SSLE-8200-LAM-DEL	SSLER-8200-LAM-DEL	2"	Laminated Phenolic	950 [†]	Delrin	13.0	9.0
SSLE-8200-HT-SSRB	SSLER-8200-HT-SSRB	2"	Hi-Temp Phenolic	1100	Stainless Roller	13.0	9.0
SSLE-8200-UN-DEL	SSLER-8200-UN-DEL	2"	Star-Tech Urethane	950 [†]	Delrin	11.5	7.5
SSLE-8200C-UBA-PBB	SSLER-8200C-UBA-PBB	2"	Urethane on Alum. (Crowned)	1500	Precision Ball	14.0	10.0
SSLE-8200C-MBA-PBB	SSLER-8200C-MBA-PBB	2"	Megabest (Crowned)	500	Precision Ball	14.5	10.5
SSLE-8200C-ES-DEL	SSLER-8200C-ES-DEL	2"	Solid Elastomer (Crowned)	950 [†]	Delrin	14.0	10.0
SSLE-8200C-ES-PBB	SSLER-8200C-ES-PBB	2"	Solid Elastomer (Crowned)	1600	Precision Ball	14.0	10.0
SSLE-8200C-EG-PBB	SSLER-8200C-EG-PBB	2"	Elastiglide (Crowned)	1500	Precision Ball	14.5	10.5
SSLE-8200-EL-DEL	SSLER-8200-EL-DEL	2"	Eliminator Grey Rubber	900	Delrin	11.5	7.5
SSLE-8200-NY-DEL	SSLER-8200-NY-DEL	2"	White Nylon	950 [†]	Delrin	12.0	8.0

- Options:** (1) Pedal Brake available on swivels and rigids. Add code 'BR' to model number (eg. SSLE/BR-8200-BAL-DEL)
 (2) Four Position Swivel Lock. Add code '4SL' to model number (eg. SSLE/4SL-5200-EL-DEL)
 (3) Flanged Brass Bearing. Substitute 'BF' for 'DEL' in Model Number (eg. SSLE-6200-NY-BF)
 (4) Stainless Steel Roller Bearing. Substitute 'SSRB' for 'DEL' in Model Number (eg. SSLE-6200-NY-SSRB)
 (5) Stainless Steel Precision Ball Bearing. Substitute 'SSPBB' for 'PBB' in Model Number (eg. SSLE-8200C-ES-SSPBB)

Note: † Higher capacities can be achieved using these wheels by substituting alternate bearing types.

SSLS/SSLR SERIES STAINLESS STEEL CASTERS



3500 lbs. Maximum Capacity

Top Plate: 4-1/2" x 6-1/4" Mounting Holes: 2-7/16" x 4-15/16" Slotted to 3-3/8" x 5-1/4" BHS 1/2" Hole Clearance



SSLS-6300-UN-DEL



SSFL-6 (See Page 50)

You simply won't find a caster anywhere to compare to this beauty. Finally there is a fully stainless steel solution for your high capacity, rough usage, applications which require a corrosive resistant, steam cleanable caster. Using the same PATENTED Double Ball Kingboltless technology as our standard LS Series caster, this heavy duty stainless caster can stand up to punishing towline and shockload applications. North American made for fast delivery and competitive pricing and are fully customizable upon request.

Note: On high-capacity stainless steel casters, stainless steel floor locks may be a much more effective alternative to wheel brakes. Consult Factory.

US Patent #: 5,983,451

Canadian Patent #: 2,179,802

Wheel Diam.	OH	Swiv. Rad.
6"	7-1/2"	5-1/2"
8"	10-1/8"	6-1/2"
10"	11-1/2"	7-3/4"
12"	13-1/2"	9"

Swivel Model Number	Rigid Model Number	Tread Width	Wheel Type	Capacity (lbs.)	Bearing Type	Weight (Approx)	
						Swivel	Rigid
6" Diameter Wheels							
SSLS-6250L-BAL-DEL	SSLR-6250L-BAL-DEL	2-1/2"	Phenolic	1600	Delrin	14.0	8.5
SSLS-6250SC-ES-PBB	SSLR-6250SC-ES-PBB	2-1/2"	Solid Elastomer (Crowned)	1500	Precision Ball	14.5	9.0
SSLS-6300-BAL-DEL	SSLR-6300-BAL-DEL	3"	Phenolic	2000	Delrin	14.5	9.0
SSLS-6300-LAM-DEL	SSLR-6300-LAM-DEL	3"	Laminated Phenolic	2500	Delrin	14.5	9.0
SSLS-6300-UN-DEL	SSLR-6300-UN-DEL	3"	Star-Tech Urethane	2250	Delrin	14.0	8.5
SSLS-6300C-UBA-PBB	SSLR-6300C-UBA-PBB	3"	Urethane on Alum. (Crowned)	2100	Precision Ball	15.5	10.0
SSLS-6300-MBA-PBB	SSLR-6300-MBA-PBB	3"	Megabest	700	Precision Ball	16.0	10.5
8" Diameter Wheels							
SSLS-8250L-BAL-DEL	SSLR-8250L-BAL-DEL	2-1/2"	Phenolic	2000	Delrin	17.0	11.0
SSLS-8250SC-ES-PBB	SSLR-8250SC-ES-PBB	2-1/2"	Solid Elastomer (Crowned)	2000	Precision Ball	18.5	12.5
SSLS-8300-BAL-DEL	SSLR-8300-BAL-DEL	3"	Phenolic	2500	Delrin	18.0	12.0
SSLS-8300-LAM-DEL	SSLR-8300-LAM-DEL	3"	Laminated Phenolic	3100	Delrin	18.0	12.0
SSLS-8300-UN-DEL	SSLR-8300-UN-DEL	3"	Star-Tech Urethane	2250	Delrin	17.0	11.0
SSLS-8300C-UBA-PBB	SSLR-8300C-UBA-PBB	3"	Urethane on Alum. (Crowned)	2550	Precision Ball	19.0	13.0
SSLS-8300-MBA-PBB	SSLR-8300-MBA-PBB	3"	Megabest	850	Precision Ball	19.5	13.5
10" Diameter Wheels							
SSLS-10250L-BAL-DEL	SSLR-10250L-BAL-DEL	2-1/2"	Phenolic	2400	Delrin	19.0	13.0
SSLS-10250SC-UBA-PBB	SSLR-10250SC-UBA-PBB	2-1/2"	Urethane on Alum. (Crowned)	3000	Precision Ball	20.0	14.0
SSLS-10250SC-MBA-PBB	SSLR-10250SC-MBA-PBB	2-1/2"	Megabest (Crowned)	1000	Precision Ball	20.0	14.0
SSLS-10250SC-ES-PBB	SSLR-10250SC-ES-PBB	2-1/2"	Solid Elastomer (Crowned)	2200	Precision Ball	21.5	15.5
SSLS-10300-BAL-DEL	SSLR-10300-BAL-DEL	3"	Phenolic	2500	Delrin	21.0	15.0
12" Diameter Wheels							
SSLS-12300-BAL-DEL	SSLR-12300-BAL-DEL	3"	Phenolic	3500	Delrin	24.0	17.5

- Options:**
- (1) T-Handle Brake available on swivels and rigids. Add code 'TBR' to model number (eg. SSLS/**TBR**-8300-BAL-DEL)
 - (2) Poly Cam Brake available on swivels and rigids. Add code 'PCB' to model number (eg. SSLS/**PCB**-6300-UN-DEL)
 - (3) Four Position Swivel Lock. Add code '4SL' to model number (eg. SSLS/**4SL**-10250SC-UBA-PBB)
 - (4) Flanged Brass Bearing. Substitute 'BF' for 'DEL' in Model Number (eg. SSLS-6300-LAM-**BF**)
 - (5) Stainless Steel Roller Bearing. Substitute 'SSRB' for 'DEL' in Model Number (eg. SSLS-6300-UN-**SSRB**)
 - (6) Stainless Steel Precision Ball Bearing. Substitute 'SSPBB' for 'PBB' in Model Number (eg. SSLS-8300C-UBA-**SSPBB**)

1,000 lbs. Maximum Capacity

Top Plate (6"-12"): 4" x 4-1/2" Mounting Holes: 2-5/8" x 3-5/8" Slotted to 3" x 3" BHS 3/8" Hole Clearance
Top Plate (16"): 4-1/2" x 6-1/4" Mounting Holes: 2-7/16" x 4-15/16" Slotted to 3-3/8" x 5-1/4" BHS 1/2" Hole Clearance
Top Plate (18"): 5-1/4" x 7-1/4" Mounting Holes: 3-3/8" x 5-1/4" Slotted to 4-1/8" x 6-1/8" BHS 1/2" Hole Clearance

These casters are ideal when used for maneuvering over rough surfaces, shock situations (i.e. delicate instruments, etc.), or anywhere that requires smooth, quiet operation of a wheeled unit. All 6" to 12" units feature the same durable double ball raceway construction as our signature "Bestway" Series casters with an attractive zinc plated finish. All 16" and 18" units are constructed using our PATENTED Double Ball

Kingboltless construction for superior performance and durability.

Wheel Diam.	OH	Swiv. Rad.
6"	7-1/2"	4-9/16"
8"	9-1/2"	6-1/16"
10"	12-1/8"	7-1/2"
12"	14-1/2"	9-1/4"
16"	19"	12-9/16"
18"	19-5/8"	14-1/4"



BW-6200-PN-RB

PC-8L-PN-BB

PC-18-PN-TB

Swivel Model Number	Rigid Model Number	Tread Width	Wheel Type	Capacity (lbs.)	Bearing Type	Weight (Approx) Swivel	Weight (Approx) Rigid
6" Diameter Wheels							
BW-6200-PN-RB	BWR-6200-PN-RB	2"	Full Pneumatic	300	Roller	6.0	4.5
8" Diameter Wheels							
PC-8L-PN-BB	PCR-8L-PN-BB	2-1/2"	Full Pneumatic	300	Ball Bearing	7.0	6.0
PC-8L-PN-RB	PCR-8L-PN-RB	2-1/2"	Full Pneumatic	300	Roller	8.5	7.5
10" Diameter Wheels							
PC-10L-PN-BB	PCR-10L-PN-BB	3-1/2"	Full Pneumatic	350	Ball Bearing	9.0	8.0
PC-10L-PN-RB	PCR-10L-PN-RB	3-1/2"	Full Pneumatic	500	Roller	12.5	11.5
12" Diameter Wheels							
PC-12L-PN-BB	PCR-12L-PN-BB	3-1/2"	Full Pneumatic	350	Ball Bearing	12.5	11.5
PC-12L-PN-RB	PCR-12L-PN-RB	3-1/2"	Full Pneumatic	650	Roller	17.0	16.0
16" Diameter Wheels							
PC-16-PN-BB	PCR-16-PN-BB	4"	Full Pneumatic	500	Ball Bearing	16.5	13.0
PC-16-PN-PBB	PCR-16-PN-PBB	4"	Full Pneumatic	745	Precision Ball	28.5	25.0
18" Diameter Wheels							
PC-18-PN-TB	PCR-18-PN-TB	5-1/4"	Full Pneumatic	1000	Tapered	43.5	35.5

- Options:** (1) Pedal Brake available on 6" to 12" swivels and rigids. Add code 'BR' to model number (eg. PC/BR-8L-PN-BB)
 (2) Poly Cam Brake available on 16" and 18" swivels and rigids. Add code 'PCB' to model number (eg. PC/PCB-16-PN-BB)
 (3) Four Position Swivel Lock. Add code '4SL' to model number (eg. PC/4SL-12L-PN-BB)
 (4) Delrin Bearing. Substitute 'DEL' for 'BB' in Model Number (eg. PC-8L-PN-DEL)

SC SERIES SCAFFOLD CASTERS

850 lbs. Maximum Capacity

Mounting: 1-3/8" x 4" Stem c/w Drift Pin Hole 2-1/2" up from Base Plate

These rugged scaffold casters feature cold forged construction, heat treated ball bearings and double welded legs to ensure longer life and higher resistance to wear. Their functional design ensures both wheel and swivel assembly lock by stepping on the brake pedal. An easy upward movement of the pedal simultaneously releases the brake and stows the pedal out of the way for moving the scaffold. This pedal action can be reversed if required. Zinc plated finish for long wear.



SC-8200-RMC-RB

Wheel Diam.	OH	Swiv. Rad.
6"	7-5/8"	5"
8"	9-3/8"	6-3/8"

Swivel Model Number	Tread Width	Wheel Type	Capacity (lbs.)	Bearing Type	Weight (Approx)
6" Diameter Wheels					
SC-6200-BAL-RB	2"	Phenolic	800	Roller	9.0
SC-6200-UC-RB	2"	Urethane on Cast	800	Roller	10.5
SC-6200-RMC-RB	2"	Rubber Moldon (H90)	800	Roller	10.0
8" Diameter Wheels					
SC-8200-BAL-RB	2"	Phenolic	850	Roller	10.0
SC-8200-UC-RB	2"	Urethane on Cast	850	Roller	13.0
SC-8200-RMC-RB	2"	Rubber Moldon (H90)	850	Roller	12.5

- Options:** (1) Delrin Bearing. Substitute 'DEL' for 'RB' in Model Number (eg. SC-8200-BAL-DEL)

SWIVEL MECHANISMS



These units are ideal for turntables, wagons or any application that requires two surfaces to rotate on a strong base. The BWSM model uses the same proven 5/8" nut & bolt kingpin construction as our BW Series casters.



BWSM



LDSM

The LDSM and IHSM models utilize our revolutionary PATENTED Double Ball Kingboltless technology for unmatched weight capacity and durability. All of our swivel mechanisms can be customized to suit your specific requirements. Other models and mounting plates are available (consult factory).

Model Number	Capacity (lbs.)	Top Plate Size	Overall Height	Swivel Type	Weight (Approx)
BWSM	1500	4-1/2" X 6-1/2"	1" + nut	Kingpin	4.5
LDSM	2500	4" X 4-1/2"	1-9/16"	Kingboltless	5.0
IHSM	30000	8-1/2" X 8-1/2"	3-3/8"	Kingboltless	44.0

Options: (1) Four Position Swivel Lock. Add code '4SL' to model number (eg. LDSM/4SL)
 (2) Other sizes and mounting types available. Consult Factory.

Note: Swivel Locks will increase the Overall Height of the unit. Consult Factory.

LADDER & DOOR CASTERS



LC-3

DC-3

Ladder & Door Casters use mounting brackets and compression springs to support the weight of a gate, door or ladder for easier movement and reduced wear on hinges/pivots. The LC Series uses a 25 lb compression spring, while the heavier DC Series uses a more robust 100 lb compression spring.

For heavier or custom applications please see our GC Series Gate Caster (below).

Swivel Model Number	Plate Size and Hole Spacing	Capacity (lbs.)	Wheel Type	Weight (Approx)
2" Diameter Wheels				
LC-2	1" X 3-3/8" c/w 2 holes 2-1/8" BHS	75	Multi-Purpose Rubber	1.5
DC-2	2" X 5-1/8" c/w 4 holes 1-1/4" x 3" BHS	75	Multi-Purpose Rubber	3.0
3" Diameter Wheels				
LC-3	1" X 3-3/8" c/w 2 holes 2-1/8" BHS	100	Multi-Purpose Rubber	1.5
DC-3	2" X 5-1/8" c/w 4 holes 1-1/4" x 3" BHS	125	Multi-Purpose Rubber	3.5

Note: Other sizes may be available. Consult Factory.

GATE CASTERS



700 lbs. Maximum Capacity

Mounting Plate: 11" x 4" Mounting Holes: 2 each 2-9/16" x 2-1/2" or



GC-6200C-ES-PBB

GC-5200-MR-RB

These high-capacity Gate Casters are ideal for use on heavy doors, gates, uneven floors or anywhere spring action is needed. The 11" x 4" plate is mounted with eight 3/8" bolts.

The heavy-duty compression spring helps support the weight of the gate. These casters are commonly used on Ice Rink gates.

Swivel Model Number	Width	Wheel Type	Capacity (lbs.)	Bearing Type	Weight (Approx)
5" Diameter Wheels					
GC-5200-MR-RB	2"	Multi-Purpose Rubber	550	Roller	12.0
GC-5200C-ES-PBB	2"	Solid Elastomer (Crowned)	700	Precision Ball	11.5
6" Diameter Wheels					
GC-6200-MR-RB	2"	Multi-Purpose Rubber	650	Roller	13.0
GC-6200C-ES-PBB	2"	Solid Elastomer (Crowned)	700	Precision Ball	12.5

Note: Other sizes and wheel types are available. Consult Factory.

These all-steel rollers are designed for ball-up applications on material handling systems. The flanged base features two (BT-10), or four (BT-15) mounting holes to facilitate easy installation and allow for quick and simple field replacement.

The BT-10 features a 1" diameter carbon steel ball rotating on 1/8" support balls mounted in a steel cup. The housing is zinc plated for a lasting, attractive finish.

The high capacity BT-15 features a 1-1/2" diameter carbon steel ball fitted with a moulded nylon seal. The main ball rotates on 3/16" hardened and ground support balls in a precision formed and hardened cup. The protective cover prohibits entry of dirt and foreign matter. The cover is zinc plated for an attractive and long lasting finish.

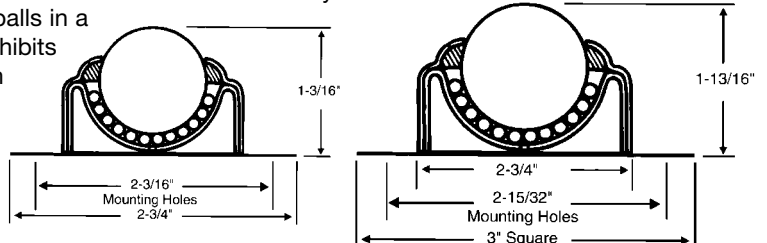

Model Number	Ball Diameter	Overall Height	Ball Type	Bolt Hole Spacing	Mounting Hole Size	Static Load Cap	Dynamic Load Cap	Weight (Approx)
BT-10	1"	1-3/16"	Steel	2-3/16"	7/32"	65 lbs.	75 lbs.	0.5
BT-15	1-1/2"	1-13/16"	Steel	2-15/32" X 2-15/32"	9/32"	250 lbs.	200 lbs.	1.5

Notes: Other sizes and materials (including Stainless Steel and Nylon Ball) may be available. Consult Factory.

BALL TRANSFERS - SINGLE STUD MOUNTED

These all-steel rollers are designed for ball-up applications on material handling systems. This model is mounted using a 5/16"-18 x 11/16" threaded stud. The 1" diameter carbon steel ball rotates on 1/8" support balls mounted in a steel cup. The housing is zinc plated for a lasting, attractive finish.

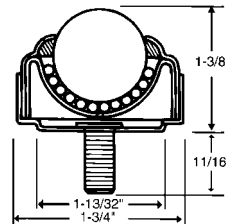

BT-10-TS 5/16"-18 x 11/16"

Model Number	Ball Diameter	Overall Height	Ball Type	Mounting Stud Length	Mounting Stud Size	Static Load Cap	Dynamic Load Cap	Weight (Approx)
BT-10-TS 5/16"-18 X 11/16"	1"	1-3/8"	Steel	11/16"	5/16"-18	65 lbs.	75 lbs.	0.5

Notes: Other sizes and materials (including Stainless Steel) may be available. Consult Factory.

CONVEYOR SKATE WHEEL

These industry standard Skate Wheels are typically used grouped together in conveyor systems. The 1-15/16" diameter formed steel wheels feature a 1/4" bore and 15/16" hub length.

Note: Other sizes may be available. Consult Factory.

Capacity: 75 lbs. (dynamic load)
Weight (Approx): 0.5



SKW-1

FC SERIES FURNITURE CASTERS



80 lbs. Maximum Capacity

Top Plate (LTP): 1-1/2" x 2-1/2" Mounting Holes: 1" x 2" BHS 3/16" Hole Clearance

Top Plate (FTP): 1-3/16" x 2" Mounting Holes: 13/16" x 1-9/16" BHS 3/16" Hole Clearance

Mounting (TS): 5/16"-18 x 1" or 3/8"-16 x 1" Threaded Stem

Mounting (SC): 7/16" x 1-3/8" Stem and Circlip

This light-duty, zinc-plated caster is ideal for light loads and where height limitations are a factor. Double ball race construction allows for easy swivel action and comes with our new soft/hard rubber wheel, making this an ideal caster for light-duty applications. These casters are competitively priced and readily available from stock. A variety of mounting types are available to suit any application.



FC-3-LTP

Large Top Plate (LTP)

These casters feature an industry standard top plate for bolt or screw mounting to any flat surface and have a matching rigid caster.



FCR-3-LTP



FC-3-FTP

Flat Top Plate (FTP)

This model uses a smaller top plate than the LTP model for mounting in tight spaces. Swivel casters only.



FC-3-TS 3/8"-16 x 1"

Threaded Stem (TS)

These models are used when flat plate types are not practical to mount. Two common stem sizes are available as standard.



FC-3-SC 7/16" x 1-3/8"

Stem & Circlip (SC)

These "grip ring" style stems are used on office chairs and other light duty socket mounting applications.

Wheel Diam.	OH	Swiv. Rad.
2" (LTP/FTP)	2-5/8"	1-7/8"
2" (TS/SC)	2-9/16"	1-7/8"
3" (LTP/FTP)	3-13/16"	2-9/16"
3" (TS/SC)	3-3/4"	2-9/16"

Swivel Model Number	Rigid Model Number	Capacity (lbs.)	Wheel Type	Mounting Type	Weight (Approx)
2" Diameter Wheels					
FC-2-LTP	FCR-2-LTP	80	Multi-Purpose Rubber	1-1/2" x 2-1/2" Top Plate	0.5
FC-2-FTP	N/A	80	Multi-Purpose Rubber	1-3/16" x 2" Top Plate	0.5
FC-2-TS 5/16"-18 x 1"	N/A	80	Multi-Purpose Rubber	5/16"-18 x 1" Threaded Stem	0.5
FC-2-TS 3/8"-16 x 1"	N/A	80	Multi-Purpose Rubber	3/8"-16 x 1" Threaded Stem	0.5
FC-2-SC 7/16" x 1-3/8"	N/A	80	Multi-Purpose Rubber	7/16" x 1-3/8" Stem & Circlip	0.5
3" Diameter Wheels					
FC-3-LTP	FCR-3-LTP	80	Multi-Purpose Rubber	1-1/2" x 2-1/2" Top Plate	1.0
FC-3-FTP	N/A	80	Multi-Purpose Rubber	1-3/16" x 2" Top Plate	1.0
FC-3-TS 5/16"-18 x 1"	N/A	80	Multi-Purpose Rubber	5/16"-18 x 1" Threaded Stem	1.0
FC-3-TS 3/8"-16 x 1"	N/A	80	Multi-Purpose Rubber	3/8"-16 x 1" Threaded Stem	1.0
FC-3-SC 7/16" x 1-3/8"	N/A	80	Multi-Purpose Rubber	7/16" x 1-3/8" Stem & Circlip	1.0

Options: (1) Pedal Brake available on swivels only. Add code 'BR' to model number (eg. FC/BR-2-LTP)

Notes: Other sizes and mounting types may be available. Consult Factory. Wheel colours may not be exactly as shown.

AL SERIES CASTERS

150 lbs. Maximum Capacity

(50-FTP): Top Plate: 2-3/8" X 2-3/8" Mounting Holes: 1-1/2" x 1-1/2" to 1-7/8" x 1-7/8" BHS 6mm Hole Clearance
 (75-FTP): Top Plate: 3-3/8" X 4-1/8" Mounting Holes: 2" x 2-3/4" to 2-1/2" x 3-1/4" BHS 9mm Hole Clearance
 (50-BH): 10mm Bolt Hole. Custom Stems Available.
 (75-BH): 12.2mm Bolt Hole. Custom Stems Available.

The AL Series standard features include a highly formed steel yoke, double ball raceway, non-marking grey rubber wheels complete with ball bearings, and thread guards, making this attractive caster ideal for hotels, institutions, and virtually any operation where a highly maneuverable, quiet, smooth rolling caster is required. The optional "Total Lock Brake" locks both the swivel and wheel with one press of the pedal. Two mounting options are available – an industry standard top plate to match models produced in Europe, and a bolt hole version for use with a wide variety of available standard and custom stems. Consult factory.



Wheel Diam.	OH	Swiv. Rad.
50mm	2-7/8"	2-1/4"
75mm	4-1/8"	2-5/8"

AL-75-FTP

AL/TLB-75-FTP

AL-75-BH

Swivel Model Number	Rigid Model Number	Capacity (lbs.)	Wheel Type	Mounting Type	Weight (Approx)
50mm (2") Diameter Wheels					
AL-50-FTP	ALR-50-FTP	80	Grey Non-Marking Rubber	2-3/8" x 2-3/8" Top Plate	0.5
AL-50-BH	N/A	80	Grey Non-Marking Rubber	10mm Bolt Hole	0.5
75mm (3") Diameter Wheels					
AL-75-FTP	ALR-75-FTP	150	Grey Non-Marking Rubber	3-3/8" x 4-1/8" Top Plate	1.5
AL-75-BH	N/A	150	Grey Non-Marking Rubber	12.2mm Bolt Hole	1.5

Options: (1) Total Lock Brake available on swivels only. Add code 'TLB' to model number (eg. AL/TLB-50-FTP)

Notes: Other sizes may be available. Consult Factory.
 See Pages 77 and 80 for drawing of actual top plates.

TWAL SERIES CASTERS

180 lbs. Maximum Capacity

(FTP): Top Plate: 2-3/8" X 2-3/8" Mounting Holes: 1-1/2" x 1-1/2" to 1-7/8" x 1-7/8" BHS 6mm Hole Clearance
 (50-BH): 10mm Bolt Hole. Custom Stems Available.
 (75-BH): 12.2mm Bolt Hole. Custom Stems Available.

This twin wheel version of our popular AL Series casters offer the improved mobility, better distribution of floor load, and increased capacity of a dual wheel caster. The optional "Total Lock Brake" locks both the swivel and wheel with one press of the pedal. Available in both top plate and bolt hole mounting styles.



TWAL-75-FTP

TWAL-75-BH

Wheel Diam.	OH	Swiv. Rad.
50mm	2-7/8"	2-3/8"
75mm	4"	3"

Swivel Model Number	Capacity (lbs.)	Wheel Type	Mounting Type	Weight (Approx)
50mm (2") Diameter Wheels				
TWAL-50-FTP	135	Grey Non-Marking Rubber	2-3/8" x 2-3/8" Top Plate	1.0
TWAL-50-BH	135	Grey Non-Marking Rubber	10mm Bolt Hole	1.0
75mm (3") Diameter Wheels				
TWAL-75-FTP	180	Grey Non-Marking Rubber	2-3/8" x 2-3/8" Top Plate	2.0
TWAL-75-BH	180	Grey Non-Marking Rubber	12.2mm Bolt Hole	1.5

Options: (1) Total Lock Brake available. Add code 'TLB' to model number (eg. TWAL/TLB-75-BH)

Notes: Other sizes may be available. Consult Factory.
 See Page 77 for drawing of actual top plates.

TWN SERIES CASTERS



These twin nylon wheel casters are ideal for a wide variety of home and office uses. A variety of mounting options are available to suit any application. Optional pedal brake available.



TWN/BR-50-FTP



TWN-50-TS 5/16"-18 x 3/4"

Wheel Diam.	OH	Swiv. Rad.
50mm	2-7/16"	1-7/8"

Swivel Model Number	Capacity (lbs.)	Wheel Type	Mounting Type	Weight (Approx)
50mm (2") Diameter Wheels				
TWN-50-FTP	75	Black Plastic	1-1/2" X 1-1/2" Plate	0.25
TWN-50-SC 7/16" X 1-1/4"	75	Black Plastic	7/16" X 1-1/4" Circlip	0.25
TWN-50-TS 5/16"-18 X 3/4"	75	Black Plastic	5/16"-18 X 3/4" Threaded	0.25
TWN-50-WS 5/16" X 1-1/2" C/W 3/8" SOCKET	75	Black Plastic	5/16" X 1-1/2" WS	0.25

Options: (1) Pedal Brake available. Add code 'BR' to model number (eg. TWN/BR-50-FTP)

Notes: Other sizes, colours and mounting types may be available. Consult Factory.

CBC SERIES CHROME BALL CASTERS

These rugged ball casters are an attractive compliment to any piece of office furniture or home application (i.e. television and stereo stands, teacarts, baby cribs, etc.). The unique wide-tread design gives maximum mobility and carpet protection. A variety of mounting options are available to suit any application.



CBC-SC 7/16" x 1-3/8"



CBC-TS 5/16"-18 x 1"



CBC-FTP

Wheel Diam.	OH	Swiv. Rad.
2" (SC)	2-1/2"	1-7/8"
2" (FTP/TS)	2-5/8"	1-7/8"

Swivel Model Number	Capacity (lbs.)	Wheel Type	Mounting Type	Weight (Approx)
2" Diameter Wheels				
CBC-FTP	75	Hard Rubber	2-1/2" X 1-1/4" Plate	0.5
CBC-SC 7/16" X 1-3/8"	75	Hard Rubber	7/16" X 1-3/8" Circlip	0.5
CBC-TS 5/16"-18 X 1"	75	Hard Rubber	5/16"-18 X 1" Threaded	0.5

Notes: Other mounting types may be available. Consult Factory.

This low-load design is ideal for mechanic's garage creepers and many other applications such as the textile and associated industries.

Capacity: 150 lbs.
Weight (Approx): 1.0

**CCS-300****HUMIDIFIER AND GENERAL PURPOSE CASTERS**

This lightweight and robust general-purpose caster is popular for use on domestic and mobile office humidifiers in addition to many other home and office applications.

Capacity: 50 lbs.
Weight (Approx): 0.25

**HC-125****RUG ROLLER CASTERS**

Bestway's rug roller casters are designed to work on either steel or wood bed frames. Generous 2-1/2" wide by 2" diameter crowned wheel affords maximum rug protection and assures a large contact surface with the floor. This attractive caster is produced in Canada for quick delivery and competitive pricing. The bright zinc finish and clean woodgrain wheel adapt to any decor.

This caster is also available with brakes.

Capacity: 110 lbs.
Weight (Approx): 0.5

**RR-200****RR-200-BR**

STAINLESS STEEL FLOOR LOCKS



These beauties are a fully stainless steel version of our Bestway Series Floor Locks. They are ideal for immobilizing rolling stock or equipment using our SS, SSRT, SSLD, SSHD and SSLE Series stainless steel casters. These Floor Locks work great where conditions prohibit wheel brakes from working properly (i.e. wet or oily floor surfaces, etc.).

SSFL-4

Model Number	Height Unlocked	Height Locked	Bolt Hole Centres	Bolt Hole Spacing	Top Plate Size	Bolt Hole Size	Weight (Approx)
SSFL-4	4-1/2"	5-5/8"	3" X 3"	2-5/8" X 3-5/8"	4" X 4-1/2"	3/8"	3.5
SSFL-6	6-1/2"	7-1/2"	3" X 3"	2-5/8" X 3-5/8"	4" X 4-1/2"	3/8"	4.0

BESTWAY FLOOR LOCKS



The Floor Lock is an ideal way to securely immobilize rolling stock or moveable equipment. Floor Locks may be welded or bolted to scaffolding, dollies, platform trucks, etc. and utilised when rolling is not required. Our Bestway Series Floor Locks can be used with a wide variety of caster series including the BW, HD, LD, LE, and LH Series.

Please note that Floor Locks are designed to firmly fix the position of the equipment, NOT to lift it off the floor.

FL-6

Model Number	Height Unlocked	Height Locked	Bolt Hole Centres	Bolt Hole Spacing	Top Plate Size	Bolt Hole Size	Weight (Approx)
FL-4	4-1/2"	5-5/8"	3" X 3"	2-5/8" X 3-5/8"	4" X 4-1/2"	3/8"	3.5
FL-5	5-3/8"	6-1/2"	3" X 3"	2-5/8" X 3-5/8"	4" X 4-1/2"	3/8"	4.0
FL-6	6-1/2"	7-1/2"	3" X 3"	2-5/8" X 3-5/8"	4" X 4-1/2"	3/8"	4.0
FL-8	8-1/2"	9-1/2"	3" X 3"	2-5/8" X 3-5/8"	4" X 4-1/2"	3/8"	4.0

Typical Floor or Truck Lock Installation Configuration

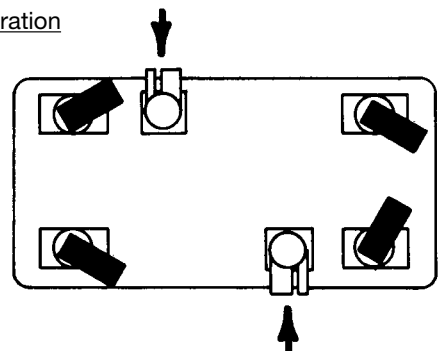
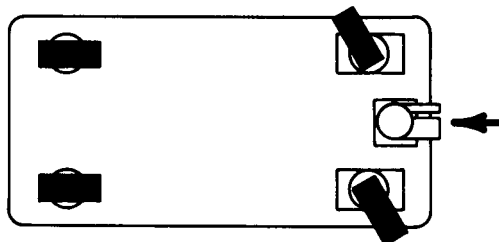

This superb floor lock is unmatched in design and performance and is adaptable to all types of portable equipment. The double pedal design will not allow the operator to place his or her foot under the load. The large steel disc foot has a rubber pad for non-slip floor contact. The zinc plated all steel construction eliminates the need for maintenance. To operate, simply press down the large activation pedal to set the positive locking force against the floor. Press down on the release pedal and the spring quickly returns the lock to the non-operating position. Both pedals are on the front of the unit for safety and ease of operation.

Please note that Floor Locks are designed to firmly fix the position of the equipment, NOT to lift it off the floor.

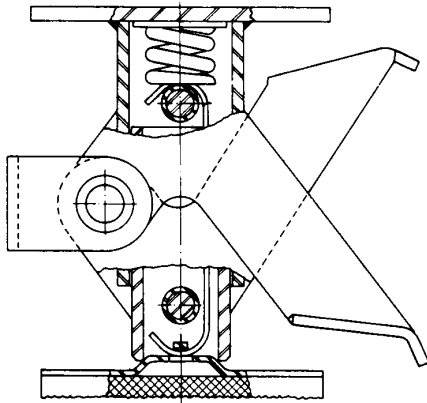

Model Number	Height Unlocked	Height Locked	Bolt Hole Centres	Bolt Hole Spacing	Top Plate Size	Bolt Hole Size	Weight (Approx)
DFL-558	4-7/8"	5-5/8"	3" X 3"	2-5/8" X 3-5/8"	3-3/4" X 4-5/8"	3/8"	4.5
DFL-634	6"	6-3/4"	3" X 3"	2-5/8" X 3-5/8"	3-3/4" X 4-5/8"	3/8"	5.0
DFL-734	7"	7-3/4"	3" X 3"	2-5/8" X 3-5/8"	3-3/4" X 4-5/8"	3/8"	5.0
DFL-934	9"	9-3/4"	3" X 3"	2-5/8" X 3-5/8"	3-3/4" X 4-5/8"	3/8"	5.0

TRUCK LOCKS

Cast from steel, these heavy-duty truck locks will securely immobilize rolling stock or moveable equipment and are easily fitted to virtually any wheeled equipment. Stepping on the pedal activates a toggle action engaging the large, spring-loaded, friction-faced brake pad to prevent inadvertent movement. Pressing the release rod disengages the lock for easy rolling.

Please note that Floor Locks are designed to firmly fix the position of the equipment, NOT to lift it off the floor.



TL-4

Model Number	Height Unlocked	Height Locked	Bolt Hole Centres	Bolt Hole Spacing	Top Plate Size	Bolt Hole Size	Weight (Approx)
TL-4	4-9/16"	5-5/8"	3" X 3"	2-5/8" X 3-5/8"	4-1/4" X 4-13/16"	3/8"	7.5
TL-6	6-11/16"	7-3/4"	2-7/16" X 4-15/16"	3-5/8" X 5-1/4"	4-3/4" X 6-1/2"	1/2"	11.0
TL-8	9-1/2"	10-1/2"	2-7/16" X 4-15/16"	3-5/8" X 5-1/4"	4-3/4" X 6-1/2"	1/2"	15.0

RUBBER CORNER BUMPERS



CB-20

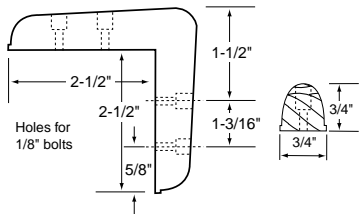

CB-331

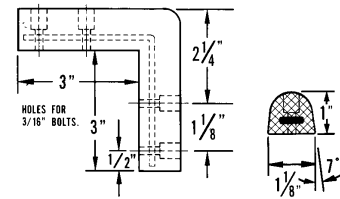

Our full range of Corner Bumpers will protect your portable equipment, walls, corridors and doors. Easy to install, these bumpers are constructed of a tough non-marking compound that will protect all surfaces.

The CB-24 Model features a built-up rounded corner to offer extra protection.



CB-24

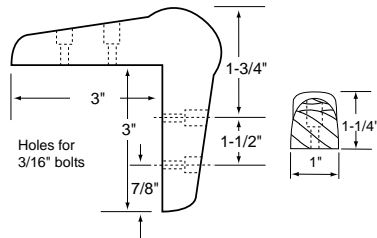

The CB-331 Model combined with our SB-333 Strip Bumper provides uniform and continuous protection around the entire unit.

Part Number	Weight (Approx)	Specifications
CB-20	0.25	See Drawing
CB-24	0.25	See Drawing
CB-331	0.50	See Drawing

RUBBER STRIP BUMPERS



SB-333

These non-marking rubber Strip Bumpers are easily applied to protect your portable equipment, walls, corridors, and doors, and do not require a special channel for installation.

Model SB-333 is used for flat surfaces and combined with our Corner Bumper CB-331 provides uniform and continuous protection around the entire unit. Available in 24' rolls, the rectangular shaped tunnel integral to the design allows for the insertion of a flat metal strip for extra strength (not included).

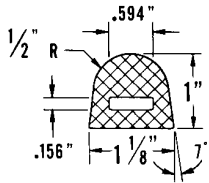

Model SB-23 is for use on 90' outside corners and comes complete with a steel insert and rounded corners for extra protection and strength.



SB-23

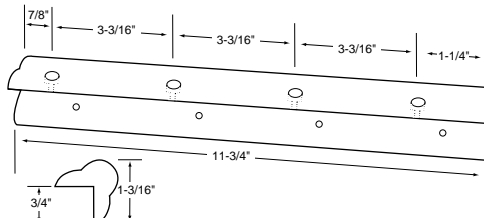

Part Number	Weight (Approx)	Specifications
SB-23	0.5	See Drawing
SB-333	0.5	See Drawing

RUBBER HANDLE BUMPERS



HB-325

Constructed of non-marking grey rubber, handle bumpers are most frequently installed on the ends of tubular handles of hand and platform trucks to give needed protection to equipment, furniture, walls and doorways. A flat steel insert is moulded into these bumpers to ensure additional strength.

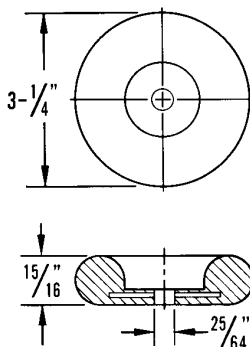

Part Number	Weight (Approx)	Specifications
HB-325	0.5	See Drawing

Our "Best-A-Lex" Phenolic wheels are made of macerated canvas or fibre-filler impregnated with phenolic resin and moulded under extreme heat and pressure into a product with a uniformly hard, smooth finish. The resulting wheel is resistant to corrosion from oil, water, grease, and commonly used solvents, and will not spark. It's uniformly hard surface means that it rolls very easily, but it is not as hard on floor surfaces as metallic wheels and will not leave marks like some rubber wheels can. They can be operated continuously in temperatures from -50° F to 250° F and intermittently to 300° F.

Special High Capacity types (LAM Series) and High-Temperature versions (HT Series) are also available.

We use only North American made Phenolic wheels to ensure quality and availability unmatched by inferior imported products.



8200-BAL-RB

Model Number	Wheel Size	Hub Length	Bearing Size	Bearing Type	Capacity (lbs.)	Wheel Face	Weight (Approx)
3125-BAL-P	3" X 1-1/4"	1-3/8"	1/2"	Plain	300	Flat	0.5
3150-BAL-RB	3" X 1-1/2"	1-5/8"	5/8" or 3/4"	Roller	600	Flat	1.0
3200-BAL-RB	3-1/4" X 2"	2-3/16"	5/8" or 3/4"	Roller	700	Flat	1.0
4125-BAL-P	4" X 1-1/4"	1-3/8"	1/2"	Plain	300	Flat	1.0
4150-BAL-RB	4" X 1-1/2"	1-5/8"	5/8" or 3/4"	Roller	600	Flat	1.0
4200-BAL-RB	4" X 2"	2-3/16"	5/8" or 3/4"	Roller	800	Flat	1.5
5125-BAL-P	5" X 1-1/4"	1-3/8"	1/2"	Plain	300	Flat	1.0
5150-BAL-RB	5" X 1-1/2"	1-5/8"	5/8" or 3/4"	Roller	600	Flat	1.5
5200-BAL-RB	5" X 2"	2-3/16"	5/8" or 3/4"	Roller	1000	Flat	2.0
6150-BAL-RB	6" X 1-1/2"	1-5/8"	5/8" or 3/4"	Roller	800	Flat	2.0
6200-BAL-RB	6" X 2"	2-3/16"	5/8" or 3/4"	Roller	1200	Flat	3.0
6250S-BAL-RB	6" X 2-1/2"	2-3/4"	1" or 1-1/4"	Roller	1600	Flat	4.5
6250L-BAL-RB	6" X 2-1/2"	3-1/4"	1" or 1-1/4"	Roller	1600	Flat	4.5
6300-BAL-RB	6" X 3"	3-1/4"	1" or 1-1/4"	Roller	2000	Flat	5.0
8200-BAL-RB	8" X 2"	2-3/16"	5/8" or 3/4"	Roller	1400	Flat	4.0
8250S-BAL-RB	8" X 2-1/2"	2-3/4"	1" or 1-1/4"	Roller	2000	Flat	6.0
8250L-BAL-RB	8" X 2-1/2"	3-1/4"	1" or 1-1/4"	Roller	2000	Flat	6.5
8300-BAL-RB	8" X 3"	3-1/4"	1" or 1-1/4"	Roller	2500	Flat	7.5
10250S-BAL-RB	10" X 2-1/2"	2-3/4"	1" or 1-1/4"	Roller	2400	Flat	7.5
10250L-BAL-RB	10" X 2-1/2"	3-1/4"	1" or 1-1/4"	Roller	2400	Flat	8.0
10300-BAL-RB	10" X 3"	3-1/4"	1" or 1-1/4"	Roller	2500	Flat	10.0
12300-BAL-RB	12" X 3"	3-1/4"	1" or 1-1/4"	Roller	3500	Flat	12.5

Options: (1) 1/2", 5/8" or 3/4" Delrin Bearing (1-1/2" and 2" Face only). Substitute "DEL" for "RB" in model number (eg. 5200-BAL-DEL)
 (2) 1" or 1-1/4" Delrin Bearing (2-1/2" and 3" Face only). Substitute "DEL" for "RB" in model number (eg. 10250L-BAL-DEL)
 (3) 5/8" or 3/4" Heavy Duty Roller Bearing (1-1/2" Face only). Substitute "HRB" for "RB" in model number (eg. 4150-BAL-HRB)
 (4) 3/4" Heavy Duty Roller Bearing (2" Face only). Substitute "HRB" for "RB" in model number (eg. 6200-BAL-HRB)
 (5) 1/2" Flanged Ball Bearing (1-1/2" and 2" Face only). Substitute "BB" for "RB" in model number (eg. 4200-BAL-BB)
 (6) 3/4" Brass Flanged Bearing (1-1/2" and 2" Face only). Substitute "BF" for "RB" in model number (eg. 6200-BAL-BF)
 (7) 1" Brass Flanged Bearing (2-1/2" and 3" Face only). Substitute "BF" for "RB" in model number (eg. 12300-BAL-BF)
 (8) 5/8" or 3/4" Vulcanized Rubber Seals (1-1/2" and 2" Face only). Add "VS" to model number (eg. 6150-BAL-RB-VS)
 (9) 1" or 1-1/4" Vulcanized Rubber Seals (2-1/2" and 3" Face only). Add "VS" to model number (eg. 8250L-BAL-RB-VS)

Notes: Wheels can be supplied with Steel, Stainless Steel or Delrin Spanner Bushings. See Page 75 for complete listing.

LAM SERIES LAMINATED TREAD PHENOLIC WHEELS

BESTWAY



This rugged and long lasting wheel is the ultimate Phenolic wheel made. Unlike regular Phenolics this wheel has laminations in the tread for increased strength and durability. The resulting wheel runs like iron but is still protective of floor surfaces. They can be used in temperatures up to 250° F (300° F intermittently) and are very good around most chemicals.

6200-LAM-RB

Model Number	Wheel Size	Hub Length	Bearing Size	Bearing Type	Capacity (lbs.)	Wheel Face	Weight (Approx)
4200-LAM-RB	4" X 2"	2-3/16"	5/8" or 3/4"	Roller	1200	Flat	1.5
5200-LAM-RB	5" X 2"	2-3/16"	5/8" or 3/4"	Roller	1400	Flat	2.0
6200-LAM-RB	6" X 2"	2-3/16"	5/8" or 3/4"	Roller	1500	Flat	3.0
6300-LAM-RB	6" X 3"	3-1/4"	1" or 1-1/4"	Roller	2500	Flat	5.0
8200-LAM-RB	8" X 2"	2-3/16"	5/8" or 3/4"	Roller	1700	Flat	4.0
8300-LAM-RB	8" X 3"	3-1/4"	1" or 1-1/4"	Roller	3100	Flat	7.5

- Options:** (1) 1/2", 5/8" or 3/4" Delrin Bearing (2" Face only). Substituted 'DEL' for 'RB' in the model number. (eg. 4200-LAM-DEL)
 (2) 1" or 1-1/4" Delrin Bearing (3" Face only). Substitute "DEL" for "RB" in model number (eg. 6300-LAM-DEL)
 (3) 3/4" Heavy Duty Roller Bearing (2" Face only). Substitute "HRB" for "RB" in model number (eg. 6200-LAM-HRB)
 (4) 3/4" Brass Flanged Bearing (2" Face only). Substitute "BF" for "RB" in model number (eg. 5200-LAM-BF)
 (5) 1" Brass Flanged Bearing (3" Face only). Substitute "BF" for "RB" in model number (eg. 8300-LAM-BF)
 (6) 5/8" or 3/4" Vulcanized Rubber Seals (2" Face only). Add "VS" to model number (eg. 5200-LAM-RB-VS)
 (7) 1" or 1-1/4" Vulcanized Rubber Seals (3" Face only). Add "VS" to model number (eg. 6300-LAM-RB-VS)

Notes: Wheels can be supplied with Steel, Stainless Steel or Delrin Spanner Bushings. See Page 75 for complete listing.

HT SERIES HI-TEMP PHENOLIC WHEELS

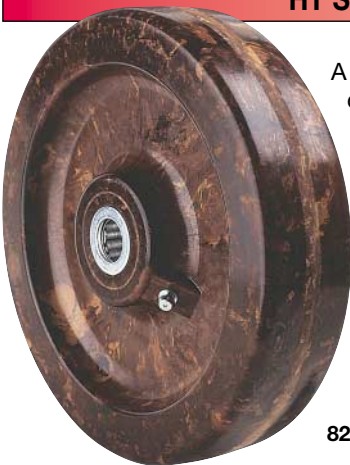

8200-HT-RB

A special Phenolic compound is used to make these wheels resistant to high heat. They can be run continuously at 475° F or intermittently at 525° F. An excellent choice instead of steel.

Model Number	Wheel Size	Hub Length	Bearing Size	Bearing Type	Capacity (lbs.)	Wheel Face	Weight (Approx)
4150-HT-RB	4" X 1-1/2"	1-5/8"	5/8" or 3/4"	Roller	400	Flat	1.0
4200-HT-RB	4" X 2"	2-3/16"	5/8" or 3/4"	Roller	500	Flat	1.5
5200-HT-RB	5" X 2"	2-3/16"	5/8" or 3/4"	Roller	750	Flat	2.0
6200-HT-RB	6" X 2"	2-3/16"	5/8" or 3/4"	Roller	900	Flat	3.0
8200-HT-RB	8" X 2"	2-3/16"	5/8" or 3/4"	Roller	1100	Flat	4.0

- Options:** (1) 5/8" or 3/4" Heavy Duty Roller Bearing (1-1/2" Face only). Substitute "HRB" for "RB" in model number (eg. 4150-HT-HRB)
 (2) 3/4" Heavy Duty Roller Bearing (2" Face only). Substitute "HRB" for "RB" in model number (eg. 6200-HT-HRB)
 (3) 3/4" Brass Flanged Bearing. Substitute "BF" for "RB" in model number (eg. 5200-HT-BF)
 (4) 3/4" Stainless Steel Roller Bearing. Substitute "SSRB" for "RB" in model number (eg. 8200-HT-SSRB)

Notes: Wheels can be supplied with Steel, Stainless Steel or Delrin Spanner Bushings. See Page 75 for complete listing.

This wheel is designed for high heat applications up to 535° F continuous (570° F intermittent) where steel wheels are not suitable. The special monolithic compound used in these wheels will outwear standard Phenolic types at least 2 to 1 and will not flake.

These wheels use our special “Hi-Lex” Teflon® Spanner Bushings that allow the wheel to continue to turn through the expansion and contraction caused by temperature change where other types squeak and bind.

**125-HTM-HL**

Model Number	Wheel Size	Hub Length	Bearing Size	Bearing Type	Capacity (lbs.)	Wheel Face	Weight (Approx)
080-HTM-HL	3" x 1-5/16"	1-5/8"	5/16"	Hi-Lex	220	Flat	0.5
100-HTM-HL	4" x 1-5/16"	1-5/8"	5/16"	Hi-Lex	275	Flat	1.0
125-HTM-HL	5" x 1-1/2"	1-7/8"	3/8"	Hi-Lex	330	Flat	1.5
150-HTM-RB	6" x 2"	2-3/16"	3/4"	Roller	660	Flat	4.0
200-HTM-RB	8" x 2"	2-3/16"	3/4"	Roller	880	Flat	5.5

BESTWAY STEEL WHEELS - THERE IS NO COMPARISON

When it comes to strength, durability, resistance and wear, nothing can match a steel wheel. However, not all steel wheels are created equal, so beware!

Bestway has long been the industry leader in the production of top quality steel wheels for all applications. We have a wide variety of wheels to suit a variety of applications and pricing requirements.

GOOD: BESTWAY PRECISION CAST STEEL WHEELS

If you're looking for great value and high quality in a cast steel wheel – look no further. An inexpensive alternative to Ductile Iron models, these wheels offer an excellent combination of strength, durability and value. This is the material used in our BST (Flat) and VG (V-Groove) Series Cast Steel Wheels.

BETTER: BESTWAY DUCTILE IRON WHEELS

Ductile Iron (also called malleable iron) is far superior to cast or forged steel wheels. It is strong enough to withstand virtually any load your equipment can carry, and unlike inferior products it will not break, chip or crack even under the most severe impact loadings. All of our Ductile Iron wheels are custom forged in North America with heavy-duty bosses and feature fully machined treads which distribute loads over the entire wheel surface for maximum floor protection. Possibly the best wheel of its type available on the market today, it is available in both flat and crowned treads (DU Series), V-Groove (VGD Series) and Flanged tread (FLD Series).

BEST: BESTWAY MACHINED STEEL WHEELS

Do you have an application where even the finest quality cast steel wheels just won't do? Then Bestway's Machined Steel Wheels are the product for you. Precision machined in our machine shop from a solid piece of high-grade machine steel, these wheels are quite simply the ultimate steel wheel available on the market today. Slab sided for maximum strength and durability, this wheel has to be seen to be believed. Available both in Steel (MS Series) and Stainless Steel (SSMS Series).

SPECIALS: BESTWAY CUSTOM MACHINING SERVICES

At Bestway we manufacture our own steel wheels. This means that all of our Steel Wheels can be fully customized by our in-house machine shop. Custom sizes (diameter, wheel face, hub length, etc.), special bore sizes, inserts, keyways and wheel faces (flat, crowned, V-grooves, U-grooves, flanges and double flanges) are all available upon request.



BST SERIES CAST STEEL WHEELS



Bestway's cast steel wheels offer an excellent combination of strength, durability and value. These easy rolling wheels offer good load bearing capability and are an inexpensive alternative to Ductile Iron models.

6200-BST-RB

Model Number	Wheel Size	Hub Length	Bearing Size	Bearing Type	Capacity (lbs.)	Wheel Face	Weight (Approx)
2-BST-P	2" X 1"	1-1/16"	1/4"	Plain	200	Flat	0.5
25-BST-P	2-1/2" X 1-1/8"	1-3/16"	5/16"	Plain	250	Flat	1.0
3125-BST-P	3" X 1-1/4"	1-1/2"	1/2"	Plain	350	Flat	1.5
3125C-BST-RB	3" X 1-1/4"	1-1/2"	1/2"	Roller	450	Crowned	2.0
3150-BST-RB	3" X 1-1/2"	1-5/8"	5/8" or 3/4"	Roller	600	Flat	2.5
3200-BST-RB	3" X 2"	2-3/16"	5/8" or 3/4"	Roller	700	Flat	3.5
4125-BST-P	4" X 1-1/4"	1-1/2"	1/2"	Plain	450	Flat	2.0
4150-BST-P	4" X 1-1/2"	1-5/8"	5/8"	Plain	650	Flat	3.0
4150-BST-RB	4" X 1-1/2"	1-5/8"	5/8" or 3/4"	Roller	650	Flat	3.0
4200-BST-RB	4" X 2"	2-3/16"	5/8" or 3/4"	Roller	800	Flat	3.5
5150-BST-RB	5" X 1-1/2"	1-5/8"	5/8" or 3/4"	Roller	700	Flat	3.0
5200-BST-RB	5" X 2"	2-3/16"	5/8" or 3/4"	Roller	825	Flat	5.0
6200-BST-RB	6" X 2"	2-3/16"	5/8" or 3/4"	Roller	1000	Flat	5.5
8200-BST-RB	8" X 2"	2-3/16"	5/8" or 3/4"	Roller	1200	Flat	9.0
14300-BST-RB	14" X 3"	3-1/4"	1" or 1-1/4"	Roller	3200	Flat	36.0

- Options:** (1) 5/8" or 3/4" Heavy Duty Roller Bearing (1-1/2" Face only). Substitute "HRB" for "RB" in model number (eg. 4150-BST-**HRB**)
 (2) 3/4" Heavy Duty Roller Bearing (2" Face only). Substitute "HRB" for "RB" in model number (eg. 6200-BST-**HRB**)
 (3) 3/4" Brass Flanged Bearing (1-1/2" and 2" Face only). Substitute "BF" for "RB" in model number (eg. 5200-BST-**BF**)
 (4) 1" Brass Flanged Bearing (3" Face only). Substitute "BF" for "RB" in model number (eg. 14300-BST-**BF**)
 (5) 5/8" or 3/4" Vulcanized Rubber Seals (1-1/2" and 2" Face only). Add "VS" to model number (eg. 8200-BST-RB-**VS**)
 (6) 1" or 1-1/4" Vulcanized Rubber Seals (3" Face only). Add "VS" to model number (eg. 14300-BST-RB-**VS**)

Notes: Wheels can be supplied with Steel, Stainless Steel or Delrin Spanner Bushings. See Page 75 for complete listing.

VG SERIES V-GROOVE CAST STEEL WHEELS



4200-VG-RB

These "V-Groove" wheels are made from Bestway's cast steel formula. Designed for use on inverted angle iron tracks, these value-priced wheels give you long life and good performance.

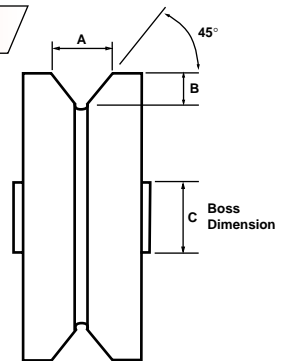

Model Number	Wheel Size	Hub Length	Bearing Size	Wheel Dimensions			Bearing Type	Capacity (lbs.)	Weight (Approx)
				A	B	C			
3150-VG-RB	3" X 1-1/2"	1-5/8"	5/8" or 3/4"	7/8"	7/16"	1-1/2"	Roller	350	2.0
4150-VG-RB	4" X 1-1/2"	1-5/8"	5/8" or 3/4"	7/8"	7/16"	1-5/8"	Roller	500	3.0
4200-VG-RB	4" X 2"	2-3/16"	5/8" or 3/4"	7/8"	7/16"	1-5/8"	Roller	800	4.5
5200-VG-RB	5" X 2"	2-3/16"	5/8" or 3/4"	7/8"	7/16"	1-3/4"	Roller	800	6.0
6200-VG-RB	6" X 2"	2-3/16"	5/8" or 3/4"	7/8"	7/16"	1-3/4"	Roller	1000	8.0

- Options:** (1) 5/8" or 3/4" Heavy Duty Roller Bearing (1-1/2" Face only). Substitute "HRB" for "RB" in model number (eg. 4150-BST-**HRB**)
 (2) 3/4" Heavy Duty Roller Bearing (2" Face only). Substitute "HRB" for "RB" in model number (eg. 6200-BST-**HRB**)
 (3) 3/4" Brass Flanged Bearing. Substitute "BF" for "RB" in model number (eg. 5200-BST-**BF**)
 (4) 5/8" or 3/4" Vulcanized Rubber Seals. Add "VS" to model number (eg. 8200-BST-RB-**VS**)

Notes: Wheels can be supplied with Steel, Stainless Steel or Delrin Spanner Bushings. See Page 75 for complete listing.

Ductile iron wheels are far superior to cast and forged steel products. Also referred to as "malleable iron", these wheels are unbelievably resistant to breakage, chipping and cracking, even under the most severe impact loadings. The special alloys used in these wheels result in load capacities far beyond those of standard steel wheels. Our heavy-duty designs feature fully machined treads that distribute loads over the entire surface for maximum floor protection. These wheels are 100% North American made to guarantee the finest possible quality, value and availability.



6200C-DU-RB

10300-DU-RB

Model Number	Wheel Size	Hub Length	Bearing Size	Bearing Type	Boss Dimension	Capacity (lbs.)	Wheel Face	Weight (Approx)
4200C-DU-RB	4" X 2"	2-3/16"	5/8", 3/4" or 1"	Roller	2"	1800	Crowned	5.0
5200C-DU-RB	5" X 2"	2-3/16"	5/8", 3/4" or 1"	Roller	2"	1800	Crowned	5.0
6200C-DU-RB	6" X 2"	2-3/16"	5/8", 3/4" or 1"	Roller	2"	1800	Crowned	7.5
6250S-DU-RB	6" X 2-1/2"	2-3/4"	1" or 1-1/4"	Roller	3"	3500	Flat	12.0
6250L-DU-RB	6" X 2-1/2"	3-1/4"	1" or 1-1/4"	Roller	3"	3500	Flat	12.0
6300-DU-RB	6" X 3"	3-1/4"	1" or 1-1/4"	Roller	3"	6000	Flat	16.0
6300-DU-TB	6" X 3"	3-1/2"	3/4" or 1"	Tapered	3"	10000	Flat	16.0
6300C-DU-RB	6" X 3"	3-1/4"	1" or 1-1/4"	Roller	3"	6000	Crowned	16.0
6300C-DU-TB	6" X 3"	3-1/2"	3/4" or 1"	Tapered	3"	8000	Crowned	16.0
6400-DU-RB	6" X 4"	4-1/4"	1-1/4" or 1-1/2"	Roller	3-1/2"	8000	Flat	21.5
6400-DU-TB	6" X 4"	4-1/2"	1-1/4"	Tapered	3-1/2"	17000	Flat	21.5
8200C-DU-RB	8" X 2"	2-3/16"	5/8", 3/4" or 1"	Roller	2"	2000	Crowned	12.0
8250S-DU-RB	8" X 2-1/2"	2-3/4"	1" or 1-1/4"	Roller	2-3/4"	3500	Flat	20.0
8250L-DU-RB	8" X 2-1/2"	3-1/4"	1" or 1-1/4"	Roller	2-3/4"	3500	Flat	20.0
8300-DU-RB	8" X 3"	3-1/4"	1" or 1-1/4"	Roller	3"	6000	Flat	23.0
8300-DU-TB	8" X 3"	3-1/2"	3/4" or 1"	Tapered	3"	10000	Flat	23.0
8300C-DU-RB	8" X 3"	3-1/4"	1" or 1-1/4"	Roller	3"	6000	Crowned	23.0
8300C-DU-TB	8" X 3"	3-1/2"	3/4" or 1"	Tapered	3"	8000	Crowned	23.0
8400-DU-RB	8" X 4"	4-1/4"	1-1/4" or 1-1/2"	Roller	3-5/8"	8000	Flat	30.0
8400-DU-TB	8" X 4"	4-1/2"	1-1/4"	Tapered	3-5/8"	17000	Flat	30.0
10250S-DU-RB	10" X 2-1/2"	2-3/4"	1" or 1-1/4"	Roller	2-5/8"	4500	Flat	18.5
10250L-DU-RB	10" X 2-1/2"	3-1/4"	1" or 1-1/4"	Roller	2-5/8"	4500	Flat	18.5
10300-DU-RB	10" X 3"	3-1/4"	1" or 1-1/4"	Roller	3-5/8"	6000	Flat	31.0
10300-DU-TB	10" X 3"	3-1/2"	3/4" or 1"	Tapered	3-5/8"	10000	Flat	31.0
10300C-DU-RB	10" X 3"	3-1/4"	1" or 1-1/4"	Roller	3-5/8"	6000	Crowned	31.0
10300C-DU-TB	10" X 3"	3-1/2"	3/4" or 1"	Tapered	3-5/8"	8000	Crowned	31.0
10400-DU-RB	10" X 4"	4-1/4"	1-1/4" or 1-1/2"	Roller	3-1/2"	8000	Flat	40.0
10400-DU-TB	10" X 4"	4-1/2"	1-1/4"	Tapered	3-1/2"	17000	Flat	40.0
12300-DU-RB	12" X 3"	3-1/4"	1" or 1-1/4"	Roller	3-5/8"	6000	Flat	40.5
12300-DU-TB	12" X 3"	3-1/2"	3/4" or 1"	Tapered	3-5/8"	10000	Flat	40.5
12300C-DU-RB	12" X 3"	3-1/4"	1" or 1-1/4"	Roller	3-5/8"	6000	Crowned	40.5
12300C-DU-TB	12" X 3"	3-1/2"	3/4" or 1"	Tapered	3-5/8"	8000	Crowned	40.5
12400-DU-RB	12" X 4"	4-1/4"	1-1/4" or 1-1/2"	Roller	3-1/2"	8000	Flat	45.5
12400-DU-TB	12" X 4"	4-1/2"	1-1/4"	Tapered	3-1/2"	17000	Flat	45.5
14500-DU-RB	14" X 5"	5-1/4"	1-1/4" or 1-1/2"	Roller	5"	10000	Flat	99.0
14500-DU-TB	14" X 5"	5-1/2"	1-1/4" or 1-1/2"	Tapered	5"	25000	Flat	99.0

Options: (1) 3/4" Heavy Duty Roller Bearing (2" Face only). Substitute "HRB" for "RB" in model number (eg. 6200C-DU-HRB)
 (2) 3/4" Brass Flanged Bearing (2" Face only). Substitute "BF" for "RB" in model number (eg. 8200C-DU-BF)
 (3) 1" Brass Flanged Bearing (2-1/2" and 3" Face only). Substitute "BF" for "RB" in model number (eg. 10250S-DU-BF)
 (4) 5/8" or 3/4" Vulcanized Rubber Seals (2" Face only). Add "VS" to model number (eg. 5200C-DU-RB-VS)

Notes: Wheels can be supplied with Steel, Stainless Steel or Delrin Spanner Bushings. See Page 75 for complete listing. Custom sizes available. Consult Factory



8400-VGD-RB

These rugged, ductile iron "V-Groove" wheels are made from the same high-performance malleable iron alloys as our DU Series wheels. Precision machined and 100% North American made, these wheels have unmatched resistance to breakage, chipping and cracking. With load capacities far greater than inferior cast or forged steel products, these wheels are the best V-Grooves available on the market.

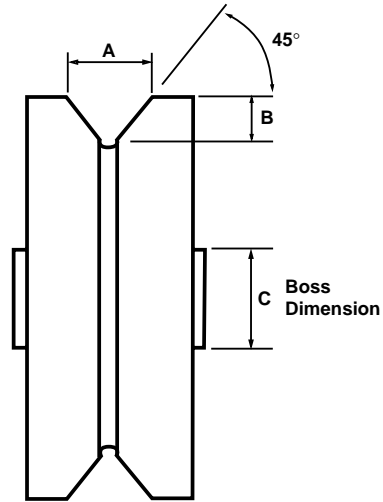

Model Number	Wheel Size	Hub Length	Bearing Size	Wheel Dimensions			Bearing Type	Capacity (lbs.)	Weight (Approx)
				A	B	C			
4200-VGD-RB	4" X 2"	2-3/16"	5/8", 3/4" or 1"	7/8"	7/16"	2"	Roller	1500	4.5
5200-VGD-RB	5" X 2"	2-3/16"	5/8", 3/4" or 1"	7/8"	7/16"	2"	Roller	1500	6.0
6200-VGD-RB	6" X 2"	2-3/16"	5/8", 3/4" or 1"	7/8"	7/16"	2"	Roller	1800	8.0
6250S-VGD-RB	6" X 2-1/2"	2-3/4"	1" or 1-1/4"	7/8"	7/16"	3"	Roller	3500	11.5
6250L-VGD-RB	6" X 2-1/2"	3-1/4"	1" or 1-1/4"	7/8"	7/16"	3"	Roller	3500	11.5
6300-VGD-RB	6" X 3"	3-1/4"	1" or 1-1/4"	1-3/8"	11/16"	3"	Roller	5000	13.5
6300-VGD-TB	6" X 3"	3-1/2"	3/4" or 1"	1-3/8"	11/16"	3"	Tapered	6000	13.5
6400-VGD-RB	6" X 4"	4-1/4"	1-1/4" or 1-1/2"	1-3/4"	7/8"	3-1/2"	Roller	8000	18.0
6400-VGD-TB	6" X 4"	4-1/2"	1-1/4"	1-3/4"	7/8"	3-1/2"	Tapered	17000	18.0
8200-VGD-RB	8" X 2"	2-3/16"	5/8", 3/4" or 1"	7/8"	7/16"	2"	Roller	2000	11.5
8250S-VGD-RB	8" X 2-1/2"	2-3/4"	1" or 1-1/4"	7/8"	7/16"	3"	Roller	3500	18.5
8250L-VGD-RB	8" X 2-1/2"	3-1/4"	1" or 1-1/4"	7/8"	7/16"	3"	Roller	3500	18.5
8300-VGD-RB	8" X 3"	3-1/4"	1" or 1-1/4"	1-3/8"	11/16"	3"	Roller	5000	20.0
8300-VGD-TB	8" X 3"	3-1/2"	3/4" or 1"	1-3/8"	11/16"	3"	Tapered	6000	20.0
8400-VGD-RB	8" X 4"	4-1/4"	1-1/4" or 1-1/2"	1-3/4"	7/8"	3-5/8"	Roller	8000	25.5
8400-VGD-TB	8" X 4"	4-1/2"	1-1/4"	1-3/4"	7/8"	3-5/8"	Tapered	17000	25.5
10300-VGD-RB	10" X 3"	3-1/4"	1" or 1-1/4"	1-3/8"	11/16"	3-5/8"	Roller	5000	27.0
10300-VGD-TB	10" X 3"	3-1/2"	3/4" or 1"	1-3/8"	11/16"	3-5/8"	Tapered	6000	27.0
10400-VGD-RB	10" X 4"	4-1/4"	1-1/4" or 1-1/2"	1-3/4"	7/8"	3-1/2"	Roller	8000	34.5
10400-VGD-TB	10" X 4"	4-1/2"	1-1/4"	1-3/4"	7/8"	3-1/2"	Tapered	17000	34.5
12300-VGD-RB	12" X 3"	3-1/4"	1" or 1-1/4"	1-3/8"	11/16"	3-5/8"	Roller	5000	36.0
12300-VGD-TB	12" X 3"	3-1/2"	3/4" or 1"	1-3/8"	11/16"	3-5/8"	Tapered	6000	36.0
12400-VGD-RB	12" X 4"	4-1/4"	1-1/4" or 1-1/2"	1-3/4"	7/8"	3-1/2"	Roller	8000	39.0
12400-VGD-TB	12" X 4"	4-1/2"	1-1/4"	1-3/4"	7/8"	3-1/2"	Tapered	17000	39.0
14500-VGD-RB	14" X 5"	5-1/4"	1-1/4" or 1-1/2"	1-3/4"	7/8"	5"	Roller	10000	92.0
14500-VGD-TB	14" X 5"	5-1/2"	1-1/4" or 1-1/2"	1-3/4"	7/8"	5"	Tapered	25000	92.0

Options: (1) 3/4" Heavy Duty Roller Bearing (2" Face only). Substitute "HRB" for "RB" in model number (eg. 4200-VGD-HRB)
 (2) 3/4" Brass Flanged Bearing (2" Face only). Substitute "BF" for "RB" in model number (eg. 6200-VGD-BF)
 (3) 1" Brass Flanged Bearing (2-1/2" and 3" Face only). Substitute "BF" for "RB" in model number (eg. 12300-VGD-BF)
 (4) 5/8" or 3/4" Vulcanized Rubber Seals (2" Face only). Add "VS" to model number (eg. 8200-VGD-RB-VS)

Notes: Wheels can be supplied with Steel, Stainless Steel or Delrin Spanner Bushings. See Page 75 for complete listing. Custom sizes available. Consult Factory

Designed to operate on steel "railroad" type tracks to minimize rolling effort and aid in guidance, these wheels offer superior wear resistance to "V-Groove" types. They are particularly suited to heat treatment operations, marine railroads, travelling cranes, bogey, skips and other transport operations. Using the same high-performance malleable iron alloys as our popular DU and VGD Series, these wheels are incredibly resistant to breakage, chipping and cracking. Load capacities, durability and performance are far superior to inferior cast and forged steel products. 100% North American made and precision machined to guarantee the highest quality, value and availability.

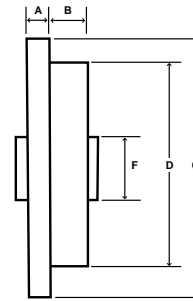

6200-FLD-RB

Model Number	Wheel Size	Hub Length	Bearing Size	Wheel Dimensions					Bearing Type	Capacity (lbs.)	Weight (Approx)
				A	B	C	D	F			
4200-FLD-RB	4" X 2"	2-3/16"	5/8", 3/4" or 1"	7/16"	1-7/16"	5"	4"	2-1/4"	Roller	1800	6.5
5200-FLD-RB	5" X 2"	2-3/16"	5/8", 3/4" or 1"	7/16"	1-7/16"	6"	5"	2-1/4"	Roller	1800	9.0
6200-FLD-RB	6" X 2"	2-3/16"	5/8", 3/4" or 1"	7/16"	1-7/16"	6-7/8"	6"	2-1/4"	Roller	2000	10.5
8200-FLD-RB	8" X 2"	2-3/16"	5/8", 3/4" or 1"	7/16"	1-9/16"	9"	8"	3-1/2"	Roller	2000	21.5
9400-FLD-P	7-3/4" X 2-1/2"	3-11/16"	1-1/2"	5/8"	2-1/2"	9-1/2"	7-3/4"	4-3/16"	Plain	8500	33.0
10400-FLD-RB	10" X 4"	4-1/4"	1-1/4" or 1-1/2"	1"	3"	12"	10"	4"	Roller	8000	71.0

- Options:** (1) 3/4" Heavy Duty Roller Bearing (2" Face only). Substitute "HRB" for "RB" in model number (eg. 6200-FLD-HRB)
 (2) 3/4" Brass Flanged Bearing (2" Face only). Substitute "BF" for "RB" in model number (eg. 8200-FLD-BF)
 (3) 5/8" or 3/4" Vulcanized Rubber Seals (2" Face only). Add "VS" to model number (eg. 5200-FLD-RB-VS)
 (4) 1-1/4" or 1-1/2" Vulcanized Rubber Seals (4" Face only). Add "VS" to model number (eg. 10400-FLD-RB-VS)

Notes: Wheels can be supplied with Steel, Stainless Steel or Delrin Spanner Bushings. See Page 75 for complete listing. Custom sizes available. Consult Factory



MS SERIES MACHINED STEEL WHEELS

Bestway's MS Series Machined Steel wheels are precision machined in-house from hot-rolled solid steel bar stock. These "Slab Sided" wheels are highly resistant to shock loads and offer incomparable strength, durability and performance. 100% North American made to ensure the highest possible quality, these wheels can be fully customised to suit your specific application.

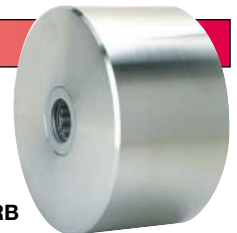

4200-MS-RB

Model Number	Wheel Size	Hub Length	Bearing Size	Bearing Type	Capacity (lbs.)	Wheel Face	Weight (Approx)
4200-MS-RB	4" X 2"	2-3/16"	5/8", 3/4" or 1"	Roller	2000	Flat	9.0
4200-MS-TB	4" X 2"	2-3/16"	1/2"	Tapered	3500	Flat	9.0
5200-MS-RB	5" X 2"	2-3/16"	5/8", 3/4" or 1"	Roller	2000	Flat	14.0
5200-MS-TB	5" X 2"	2-3/16"	1/2"	Tapered	3500	Flat	14.0
6200-MS-RB	6" X 2"	2-3/16"	5/8", 3/4" or 1"	Roller	2000	Flat	20.0
6200-MS-TB	6" X 2"	2-3/16"	1/2"	Tapered	3500	Flat	20.0

- Options:** (1) 3/4" Heavy Duty Roller Bearing. Substitute "HRB" for "RB" in model number (eg. 6200-MS-HRB)
 (2) 3/4" Brass Flanged Bearing. Substitute "BF" for "RB" in model number (eg. 5200-MS-BF)
 (3) 5/8" or 3/4" Vulcanized Rubber Seals. Add "VS" to model number (eg. 5200-MS-RB-VS)

Notes: Wheels can be supplied with Steel, Stainless Steel or Delrin Spanner Bushings. See Page 75 for complete listing. Custom sizes available. Consult Factory



SSMS SERIES STAINLESS STEEL MACHINED STEEL WHEELS

These unique wheels are precision machined in-house from solid high-grade stainless steel bar stock. Ideal for use in high capacity applications where the utility of metal is required but resistance to corrosion and cleanliness are a must. 100% North American made and fully customizable (i.e. v-grooves, etc.), these wheels must be seen to be believed!



6200-SSMS-SSRB

Model Number	Wheel Size	Hub Length	Bearing Size	Bearing Type	Capacity (lbs.)	Wheel Face	Weight (Approx)
4200-SSMS-SSRB	4" X 2"	2-3/16"	3/4"	Stainless Roller	1500	Flat	9.0
6200-SSMS-SSRB	6" X 2"	2-3/16"	3/4"	Stainless Roller	1800	Flat	20.0

Notes: Wheels can be supplied with Steel, Stainless Steel or Delrin Spanner Bushings. See Page 75 For complete listing. Custom sizes available. Consult Factory

UN SERIES URETHANE WHEELS

BESTWAY



6200-UN-RB

Polyurethane wheels offer superior abrasion and tear resistance to rubber and are also non-marking and have higher load bearing capacities. Our lightweight UN Series wheels feature a 95A durometer (nominal) polyurethane tread bonded to a high-impact polyolefin core. The resulting wheel meets the stringent requirements of clinical environments such as the food industry, laboratories as well as the standard of hygiene required in the catering and cleaning professions. It is also ideal for cart wash operations. The hard polyurethane tread surface makes for an easy rolling wheel that is highly resistant to weather and corrosive environments.

Model Number	Wheel Size	Hub Length	Bearing Size	Bearing Type	Capacity (lbs.)	Wheel Face	Weight (Approx)
2-UN-P	2" X 7/8"	1"	1/4"	Plain	120	Flat	0.5
3125-UN-BB	3" X 1-1/4"	1-1/2"	3/8"	Ball Bearing	250	Flat	0.5
4125-UN-BB	4" X 1-1/4"	1-1/2"	3/8"	Ball Bearing	250	Flat	1.0
4150-UN-RB	4" X 1-1/2"	1-5/8"	5/8" or 3/4"	Roller	440	Flat	1.0
4200-UN-RB	4" X 2"	2-3/16"	5/8" or 3/4"	Roller	600	Flat	1.0
5125-UN-BB	5" X 1-1/4"	1-1/2"	3/8"	Ball Bearing	250	Flat	1.0
5150-UN-RB	5" X 1-1/2"	1-5/8"	5/8" or 3/4"	Roller	500	Flat	1.0
5200-UN-RB	5" X 2"	2-3/16"	5/8" or 3/4"	Roller	750	Flat	1.5
6150-UN-RB	6" X 1-1/2"	1-5/8"	5/8" or 3/4"	Roller	600	Flat	1.5
6200-UN-RB	6" X 2"	2-3/16"	5/8" or 3/4"	Roller	900	Flat	2.0
6300-UN-RB	6" X 3"	3-1/4"	1" or 1-1/4"	Roller	2250	Flat	4.5
8200-UN-RB	8" X 2"	2-3/16"	5/8" or 3/4"	Roller	1000	Flat	2.5
8300-UN-RB	8" X 3"	3-1/4"	1" or 1-1/4"	Roller	2250	Flat	6.5

- Options:**
- (1) 1/2" Delrin Bearing (1-1/4" Face only). Substitute "DEL" for "BB" in model number (eg. 3125-UN-DEL)
 - (2) 1/2", 5/8" or 3/4" Delrin Bearing (1-1/2" and 2" Face only). Substitute "DEL" for "RB" in model number (eg. 5200-UN-DEL)
 - (3) 1" or 1-1/4" Delrin Bearing (3" Face only). Substitute "DEL" for "RB" in model number (eg. 8300-UN-DEL)
 - (4) 1/2" Flanged Ball Bearing (1-1/2" and 2" Face only). Substitute "BB" for "RB" in model number (eg. 4200-UN-BB)
 - (5) 3/4" Stainless Steel Roller Bearing (1-1/2" and 2" Face only). Substitute "SSRB" for "RB" in model number (eg. 6200-UN-SSRB)
 - (6) 1" Stainless Steel Roller Bearing (3" Face only). Substitute "SSRB" for "RB" in model number (eg. 6300-UN-SSRB)
 - (7) 5/8" or 3/4" Vulcanized Rubber Seals (1-1/2" and 2" Face only). Add "VS" to model number (eg. 8200-UN-RB-VS)
 - (8) 1" or 1-1/4" Vulcanized Rubber Seals (3" Face only). Add "VS" to model number (eg. 8300-UN-RB-VS)

Notes: Wheels can be supplied with Steel, Stainless Steel or Delrin Spanner Bushings. See Page 75 for complete listing.

UNY SERIES URETHANE ON WHITE NYLON WHEELS (formerly NDRX Series)



125-UNY-SSRB

This wheel was specially designed for use with our SSGP and SSBH Series Stainless Steel Casters. It features a red 95A durometer (nominal) Polyurethane tread bonded to a #6 Nylon core. Stainless steel roller bearings are standard. This wheel is completely waterproof, highly impact and chemical resistant and can safely be steam cleaned. It is ideal for poultry plants, slaughterhouses, cheese plants, hospitals and drug processing industries. The hard polyurethane tread is easy rolling, non-marking and reasonably quiet.

Model Number	Wheel Size	Hub Length	Bearing Size	Bearing Type	Capacity (lbs.)	Wheel Face	Weight (Approx)
080-UNY-SSRB	80mm x 30mm	40mm	12mm	Stainless Roller	220	Flat	0.5
100-UNY-SSRB	100mm x 30mm	40mm	12mm	Stainless Roller	240	Flat	0.5
125-UNY-SSRB	125mm x 30mm	46mm	15mm	Stainless Roller	400	Flat	1.0

Our UC Series "Urethane on Cast" wheels are composed of a 95A durometer (nominal) polyurethane tread formed on a cast steel core. The special bonding process results in a wheel of outstanding shock, load and abrasion resistance. They are much more durable than rubber tread wheels and are highly resistant to most oils, chemicals and solvents. The precision cast core gives it load ratings comparable to steel and the polyurethane tread is non-marking, relatively quiet, protects the floor surface and has an elastic memory which prevents permanent flat-spotting.

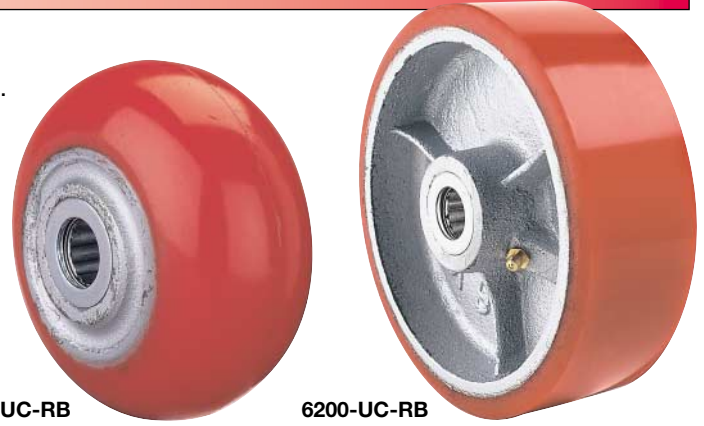

4200C-UC-RB

6200-UC-RB

Model Number	Wheel Size	Hub Length	Bearing Size	Bearing Type	Capacity (lbs.)	Wheel Face	Weight (Approx)
3150-UC-RB	3" X 1-1/2"	1-5/8"	5/8" or 3/4"	Roller	400	Flat	2.0
3200-UC-RB	3" X 2"	2-3/16"	5/8" or 3/4"	Roller	540	Flat	2.5
4150-UC-RB	4" X 1-1/2"	1-5/8"	5/8" or 3/4"	Roller	600	Flat	2.0
4200-UC-RB	4" X 2"	2-3/16"	5/8" or 3/4"	Roller	700	Flat	3.0
4200C-UC-RB	4" X 2"	2-3/16"	5/8" or 3/4"	Roller	800	Crowned	3.0
5150-UC-RB	5" X 1-1/2"	1-5/8"	5/8" or 3/4"	Roller	720	Flat	3.0
5200-UC-RB	5" X 2"	2-3/16"	5/8" or 3/4"	Roller	1050	Flat	3.5
5200C-UC-RB	5" X 2"	2-3/16"	5/8" or 3/4"	Roller	1000	Crowned	3.5
6150-UC-RB	6" X 1-1/2"	1-5/8"	5/8" or 3/4"	Roller	840	Flat	3.5
6200-UC-RB	6" X 2"	2-3/16"	5/8" or 3/4"	Roller	1230	Flat	4.5
6200C-UC-RB	6" X 2"	2-3/16"	5/8" or 3/4"	Roller	1050	Crowned	4.5
6250S-UC-RB	6" X 2-1/2"	2-3/4"	1" or 1-1/4"	Roller	1600	Flat	9.0
6250L-UC-RB	6" X 2-1/2"	3-1/4"	1" or 1-1/4"	Roller	1600	Flat	10.5
6300-UC-RB	6" X 3"	3-1/4"	1" or 1-1/4"	Roller	2050	Flat	11.0
6300-UC-TB	6" X 3"	3-1/2"	3/4" or 1"	Tapered	2050	Flat	11.0
6400-UC-RB	6" X 4"	4-1/4"	1-1/4" or 1-1/2"	Roller	5750	Flat	20.0
6400-UC-TB	6" X 4"	4-1/2"	1-1/4"	Tapered	5750	Flat	20.0
8200-UC-RB	8" X 2"	2-3/16"	5/8" or 3/4"	Roller	1500	Flat	7.0
8200C-UC-RB	8" X 2"	2-3/16"	5/8" or 3/4"	Roller	1250	Crowned	6.5
8250S-UC-RB	8" X 2-1/2"	2-3/4"	1" or 1-1/4"	Roller	1800	Flat	13.0
8250L-UC-RB	8" X 2-1/2"	3-1/4"	1" or 1-1/4"	Roller	1800	Flat	13.5
8300-UC-RB	8" X 3"	3-1/4"	1" or 1-1/4"	Roller	2500	Flat	16.0
8300-UC-TB	8" X 3"	3-1/2"	3/4" or 1"	Tapered	2500	Flat	16.0
8400-UC-RB	8" X 4"	4-1/4"	1-1/4" or 1-1/2"	Roller	5750	Flat	24.5
8400-UC-TB	8" X 4"	4-1/2"	1-1/4"	Tapered	5750	Flat	24.5
10250S-UC-RB	10" X 2-1/2"	2-3/4"	1" or 1-1/4"	Roller	2300	Flat	20.0
10250L-UC-RB	10" X 2-1/2"	3-1/4"	1" or 1-1/4"	Roller	2300	Flat	22.0
10300-UC-RB	10" X 3"	3-1/4"	1" or 1-1/4"	Roller	2800	Flat	23.0
10300-UC-TB	10" X 3"	3-1/2"	3/4" or 1"	Tapered	2800	Flat	23.0
10400-UC-RB	10" X 4"	4-1/4"	1-1/4" or 1-1/2"	Roller	5750	Flat	30.0
10400-UC-TB	10" X 4"	4-1/2"	1-1/4"	Tapered	5750	Flat	30.0
12300-UC-RB	12" X 3"	3-1/4"	1" or 1-1/4"	Roller	3200	Flat	29.0
12300-UC-TB	12" X 3"	3-1/2"	3/4" or 1"	Tapered	3200	Flat	29.0
12400-UC-RB	12" X 4"	4-1/4"	1-1/4" or 1-1/2"	Roller	5750	Flat	37.0
12400-UC-TB	12" X 4"	4-1/2"	1-1/4"	Tapered	5750	Flat	37.0
16300-UC-RB	16" X 3"	3-1/4"	1" or 1-1/4"	Roller	4000	Flat	46.0
16300-UC-TB	16" X 3"	3-1/2"	3/4" or 1"	Tapered	4200	Flat	46.0
16500-UC-TB	16" X 5"	5-1/2"	1-1/4" or 1-1/2"	Tapered	8400	Flat	76.5

Options: (1) 1/2", 5/8" or 3/4" Delrin Bearing (1-1/2" and 2" Face only). Substitute "DEL" for "RB" in model number (eg. 5200-UC-DEL)
 (2) 1" or 1-1/4" Delrin Bearing (2-1/2" and 3" Face only). Substitute "DEL" for "RB" in model number (eg. 10250L-UC-DEL)
 (3) 5/8" or 3/4" Heavy Duty Roller Bearing (1-1/2" Face only). Substitute "HRB" for "RB" in model number (eg. 4150-UC-HRB)
 (4) 3/4" Heavy Duty Roller Bearing (2" Face only). Substitute "HRB" for "RB" in model number (eg. 6200-UC-HRB)
 (5) 1/2" Flanged Ball Bearing (1-1/2" and 2" Face only). Substitute "BB" for "RB" in model number (eg. 4200-UC-BB)
 (6) 3/4" Brass Flanged Bearing (1-1/2" and 2" Face only). Substitute "BF" for "RB" in model number (eg. 6200-UC-BF)
 (7) 1" Brass Flanged Bearing (2-1/2" and 3" Face only). Substitute "BF" for "RB" in model number (eg. 12300-UC-BF)
 (8) 5/8" or 3/4" Vulcanized Rubber Seals (1-1/2" and 2" Face only). Add "VS" to model number (eg. 5200C-UC-RB-VS)

Notes: Wheels can be supplied with Steel, Stainless Steel or Delrin Spanner Bushings. See Page 75 for complete listing.

UBA SERIES URETHANE ON ALUMINUM WHEELS



10250SC-UBA-PBB



8200C-UBA-PBB

These high performance wheels feature a bright red 95A Polyurethane (nominal) tread mechanically and chemically bonded to an aluminum core. The Polyurethane is specially treated to form an extra tough skin designed to resist debris pick-up. These wheels are non-marking and highly resistant oils, solvents, fats, greases and many chemicals. The crowned wheel face and standard precision ball bearings make this wheel perfect for towline applications.

Model Number	Wheel Size	Hub Length C/W Top Hats	Axle Size	Bearing Type	Capacity (lbs.)	Wheel Face	Weight (Approx)
4200C-UBA-PBB	4" X 2"	2-7/16"	1/2"	Precision Ball	900	Crowned	2.0
5200C-UBA-PBB	5" X 2"	2-7/16"	1/2"	Precision Ball	900	Crowned	2.0
6200C-UBA-PBB	6" X 2"	2-7/16"	1/2"	Precision Ball	1200	Crowned	3.0
6300C-UBA-PBB	6" X 3"	3-1/2"	3/4"	Precision Ball	2100	Crowned	6.0
8200C-UBA-PBB	8" X 2"	2-7/16"	1/2"	Precision Ball	1500	Crowned	5.0
8300C-UBA-PBB	8" X 3"	3-1/2"	3/4"	Precision Ball	2550	Crowned	8.5
10250SC-UBA-PBB	10" X 2-1/2"	3" or 3-1/2"	3/4"	Precision Ball	3000	Crowned	9.0

Options: (1) Stainless Steel Precision Ball Bearings. Substitute "SSPBB" for "PBB" in model number (eg. 6200C-UBA-SSPBB)

Notes: Custom sizes available. Consult Factory.

MBA SERIES MEGABEST URETHANE ON ALUMINUM WHEELS



8300-MBA-PBB



6200C-MBA-PBB

Our revolutionary "Megabest" wheels are a true innovation in polyurethane wheel designs. The tread is formed of high performance 70A durometer (nominal) Polyurethane mechanically and chemically bonded to an aluminum core. The Polyurethane is specially treated to form an extra tough skin designed to resist debris pick-up. The resulting wheel offers the soft cushion ride of rubber with the wear and improved life of an elastomer. In addition to being non-marking, it is also highly resistant to oils, solvents, fats, greases and many chemicals. Standard precision ball bearings make this wheel ideal for towline applications. The smooth cushioned ride make this wheel perfect for use with delicate equipment and instruments. Noise reduction is significant over harder Polyurethane models. This wheel is a winner all the way around!

Model Number	Wheel Size	Hub Length C/W Top Hats	Axle Size	Bearing Type	Capacity (lbs.)	Wheel Face	Weight (Approx)
4200C-MBA-PBB	4" X 2"	2-7/16"	1/2"	Precision Ball	300	Crowned	2.0
5200C-MBA-PBB	5" X 2"	2-7/16"	1/2"	Precision Ball	300	Crowned	2.0
6200C-MBA-PBB	6" X 2"	2-7/16"	1/2"	Precision Ball	400	Crowned	3.0
6300-MBA-PBB	6" X 3"	3-1/2"	3/4"	Precision Ball	700	Flat	6.5
8200C-MBA-PBB	8" X 2"	2-7/16"	1/2"	Precision Ball	500	Crowned	5.5
8300-MBA-PBB	8" X 3"	3-1/2"	3/4"	Precision Ball	850	Flat	9.0
10250SC-MBA-PBB	10" X 2-1/2"	3" or 3-1/2"	3/4"	Precision Ball	1000	Crowned	9.0

Options: (1) Stainless Steel Precision Ball Bearings. Substitute "SSPBB" for "PBB" in model number (eg. 6200C-MBA-SSPBB)

Notes: Custom sizes available. Consult Factory.

Continuing research by Bestway has produced this solid Elastomer one-piece caster wheel. Moulded from hard 70D durometer (nominal) Polyurethane to produce a very easy rolling wheel, they have excellent resistance to oils, solvents, fats, greases and many chemicals. This style of wheel eliminates the problem of tread separation that may occur on wheels where the tread is bonded to a separate hub. Being polyurethane, they have greater abrasion and tear resistance and higher load capacity than rubber, offer superior impact resistance and have an elastic memory to help prevent permanent flat spotting. Designed to operate in temperatures ranging from -20° F to 180° F and available with sealed precision ball bearings suitable for towline applications. The pleasing blue colour makes this wheel stand out from others.



Model Number	Wheel Size	Hub Length	Bearing Size	Bearing Type	Capacity (lbs.)	Wheel Face	Weight (Approx)
3150C-ES-HRB	3" X 1-1/2"	1-5/8"	5/8" or 3/4"	Heavy Duty Roller	350	Crowned	1.0
4150C-ES-HRB	4" X 1-1/2"	1-5/8"	5/8" or 3/4"	Heavy Duty Roller	400	Crowned	1.0
4200C-ES-HRB	4" X 2"	2-3/16"	3/4"	Heavy Duty Roller	800	Crowned	1.5
4200C-ES-PBB	4" X 2"	2-7/16" c/w Top Hats	1/2" Axle	Precision Ball	800	Crowned	1.5
5150C-ES-HRB	5" X 1-1/2"	1-5/8"	5/8" or 3/4"	Heavy Duty Roller	500	Crowned	1.5
5200C-ES-HRB	5" X 2"	2-3/16"	3/4"	Heavy Duty Roller	1000	Crowned	1.5
5200C-ES-PBB	5" X 2"	2-7/16" c/w Top Hats	1/2" Axle	Precision Ball	1000	Crowned	1.5
6200-ES-HRB	6" X 2"	2-3/16"	3/4"	Heavy Duty Roller	1200	Flat	2.5
6200-ES-PBB	6" X 2"	2-7/16" c/w Top Hats	1/2" Axle	Precision Ball	1200	Flat	2.5
6200C-ES-HRB	6" X 2"	2-3/16"	3/4"	Heavy Duty Roller	1200	Crowned	2.5
6200C-ES-PBB	6" X 2"	2-7/16" c/w Top Hats	1/2" Axle	Precision Ball	1200	Crowned	2.5
6250SC-ES-PBB	6" X 2-1/2"	3" or 3-1/2" c/w Top Hats	3/4" Axle	Precision Ball	1500	Crowned	5.0
8200-ES-HRB	8" X 2"	2-3/16"	3/4"	Heavy Duty Roller	1600	Flat	3.5
8200-ES-PBB	8" X 2"	2-7/16" c/w Top Hats	1/2" Axle	Precision Ball	1600	Flat	3.5
8200C-ES-HRB	8" X 2"	2-3/16"	3/4"	Heavy Duty Roller	1600	Crowned	5.0
8200C-ES-PBB	8" X 2"	2-7/16" c/w Top Hats	1/2" Axle	Precision Ball	1600	Crowned	5.0
8250SC-ES-PBB	8" X 2-1/2"	3" or 3-1/2" c/w Top Hats	3/4" Axle	Precision Ball	2000	Crowned	8.0
10250SC-ES-PBB	10" X 2-1/2"	3" or 3-1/2" c/w Top Hats	3/4" Axle	Precision Ball	2200	Crowned	10.5

Options: (1) 1/2", 5/8" or 3/4" Delrin Bearing (1-1/2" and 2" Face only). Substitute "DEL" for "HRB" in model number (eg. 5200C-ES-DEL)
 (2) 3/4" Stainless Roller Bearing (1-1/2" and 2" Face only). Substitute "SSRB" for "HRB" in model number (eg. 5200C-ES-SSRB)
 (3) Stainless Steel Precision Ball Bearing. Substitute "SSPBB" for "PBB" in model number (eg. 8200C-ES-SSPBB)
 (4) 5/8" or 3/4" Vulcanized Rubber Seals (1-1/2" and 2" Face only). Add "VS" to model number (eg. 5200C-ES-HRB-VS)

Notes: Wheels can be supplied with Steel, Stainless Steel or Delrin Spanner Bushings. See Page 75 for complete listing. Custom sizes available. Consult Factory

EG SERIES ELASTIGLIDE URETHANE WHEELS

Our EG Series "Elastiglide" wheels feature a hard 70D durometer (nominal) Polyurethane tread mechanically and chemically bonded to an aluminum core. This unique system extends the core into the tread thus virtually locking the tread to the core. The half-round tread design will aid in any casters swivelling action. Precision ball bearings are standard, making this wheel excellent for heavy-duty applications. The hard Polyurethane tread results in a wheel that rolls extremely well and is highly resistant to oils, solvents, fats, greases and many chemicals.



8200C-EG-PBB

Model Number	Wheel Size	Hub Length C/W Top Hats	Axle Size	Bearing Type	Capacity (lbs.)	Wheel Face	Weight (Approx)
6200C-EG-PBB	6" X 2"	2-7/16"	1/2"	Precision Ball	1200	Crowned	3.0
8200C-EG-PBB	8" X 2"	2-7/16"	1/2"	Precision Ball	1500	Crowned	5.5

Options: (1) Stainless Steel Precision Ball Bearing. Substitute "SSPBB" for "PBB" in model number (eg. 8200C-EG-SSPBB)

Notes: Custom sizes available. Consult Factory

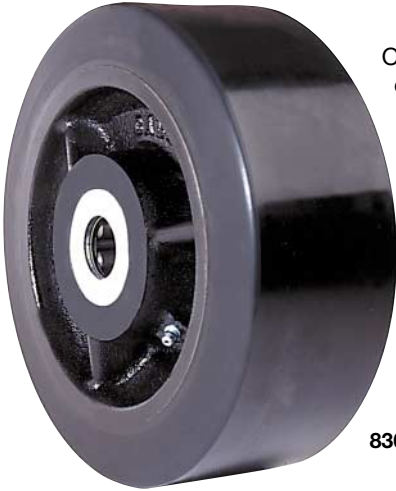

8300-UDU-RB

Our unique UDU Series wheels are the best high-capacity Polyurethane tread wheels available on the market. Designed specifically for use with our heavy-duty PATENTED Double Ball Kingboltless casters, these wheels feature an extremely hard Polyurethane tread bonded to a core made from our high performance Ductile Iron wheels. The resulting wheel has an extremely high load bearing capacity combined with the floor protective properties of a Polyurethane tread wheel.

Model Number	Wheel Size	Hub Length	Bearing Size	Bearing Type	Capacity (lbs.)	Wheel Face	Weight (Approx)
6300-UDU-RB	6" X 3"	3-1/4"	1" or 1-1/4"	Roller	5000	Flat	17.5
6300-UDU-TB	6" X 3"	3-1/2"	3/4" or 1"	Tapered	9000	Flat	17.5
6400-UDU-RB	6" X 4"	4-1/4"	1-1/4" or 1-1/2"	Roller	8000	Flat	21.0
6400-UDU-TB	6" X 4"	4-1/2"	1-1/4"	Tapered	17000	Flat	21.0
8300-UDU-RB	8" X 3"	3-1/4"	1" or 1-1/4"	Roller	6000	Flat	18.5
8300-UDU-TB	8" X 3"	3-1/2"	3/4" or 1"	Tapered	9000	Flat	18.5
8400-UDU-RB	8" X 4"	4-1/4"	1-1/4" or 1-1/2"	Roller	8000	Flat	25.5
8400-UDU-TB	8" X 4"	4-1/2"	1-1/4"	Tapered	17000	Flat	25.5
10300-UDU-RB	10" X 3"	3-1/4"	1" or 1-1/4"	Roller	6000	Flat	26.5
10300-UDU-TB	10" X 3"	3-1/2"	3/4" or 1"	Tapered	9000	Flat	26.5
10400-UDU-RB	10" X 4"	4-1/4"	1-1/4" or 1-1/2"	Roller	8000	Flat	35.0
10400-UDU-TB	10" X 4"	4-1/2"	1-1/4"	Tapered	17000	Flat	35.0
12300-UDU-RB	12" X 3"	3-1/4"	1" or 1-1/4"	Roller	6000	Flat	35.5
12300-UDU-TB	12" X 3"	3-1/2"	3/4" or 1"	Tapered	9000	Flat	35.5
12400-UDU-RB	12" X 4"	4-1/4"	1-1/4" or 1-1/2"	Roller	8000	Flat	46.0
12400-UDU-TB	12" X 4"	4-1/2"	1-1/4"	Tapered	17000	Flat	46.0
16500-UDU-RB	16" X 5"	5-1/4"	1-1/4" or 1-1/2"	Roller	10000	Flat	109.0
16500-UDU-TB	16" X 5"	5-1/2"	1-1/4" or 1-1/2"	Tapered	25000	Flat	109.0

Options: (1) 1" Brass Flanged Bearing (3" Face only). Substitute "BF" for "RB" in model number (eg. 12300-UDU-BF)
 (2) 1" or 1-1/4" Vulcanized Rubber Seals (3" Face only). Add "VS" to model number (eg. 6300-UDU-RB-VS)
 (3) 1-1/4" or 1-1/2" Vulcanized Rubber Seals (4" Face only). Add "VS" to model number (eg. 12400-UDU-RB-VS)

Notes: Custom sizes and Polyurethane durometers available. Consult Factory.

BESTWAY CUSTOM POLYURETHANE WHEELS

At Bestway we know that "off the shelf" products often just won't work for those special applications. That's why we offer our customers a full range of custom polyurethane wheel options to find the perfect product to fit their needs. It doesn't matter if it's a small variation or a totally unique wheel, one piece or a thousand - Bestway can help!

- We can make you a wheel using virtually any durometer of Polyurethane in a wide range of colours.
- Solid Polyurethane wheels or use Aluminum, Ductile Iron, Machined Steel or even Stainless Steel Hubs.
- Any wheel size to suite your needs (diameter, wheel face, hub length, etc.)
- Custom bore sizes, bearing types, inserts and keyways are always available.

Other Options: If the right Polyurethane wheel just can't be found to suit your needs, why not try a custom wheel made from our machineable UHMW ("Ultra High Molecular Weight") Polyethylene material? Approved for use with food, suitable for wet environments, and UV stabilized for outdoor use, it can be custom machined to suit your every need (including V-groove and flanged wheels). A pleasing white colour, it is an excellent alternative to white Polyolefin or Nylon wheels.

Bestway's MR Series rubber wheel is the best of both worlds. This advanced design combines the higher load capacity and ease of movement offered by a hard rubber wheel with the cushioning effect of a soft rubber wheel. These wheels are ideal for a wide range of industrial applications.



4150-MR-RB



5150-MR-RB

Model Number	Wheel Size	Hub Length	Bearing Size	Bearing Type	Capacity (lbs.)	Wheel Face	Weight (Approx)
2-MR-P	2" X 7/8"	1"	1/4"	Plain	120	Flat	0.5
25-MR-P	2-1/2" X 1-1/8"	1-3/8"	5/16"	Plain	150	Flat	0.5
3125-MR-P	3" X 1-1/4"	1-1/2"	3/8"	Plain	210	Flat	0.5
4138-MR-P	4" X 1-3/8"	1-15/32"	3/8"	Plain	300	Flat	1.5
4150-MR-RB	4" X 1-1/2"	1-5/8"	5/8" or 3/4"	Roller	400	Flat	1.5
4200-MR-RB	4" X 2"	2-3/16"	5/8" or 3/4"	Roller	450	Flat	2.0
5138-MR-P	5" X 1-3/8"	1-15/32"	3/8"	Plain	300.	Flat	1.5
5150-MR-RB	5" X 1-1/2"	1-5/8"	5/8" or 3/4"	Roller	450	Flat	2.0
5200-MR-RB	5" X 2"	2-3/16"	5/8" or 3/4"	Roller	550	Flat	2.0
6150-MR-RB	6" X 1-1/2"	1-5/8"	5/8" or 3/4"	Roller	550	Flat	2.0
6200-MR-RB	6" X 2"	2-3/16"	5/8" or 3/4"	Roller	650	Flat	3.0
8200-MR-RB	8" X 2"	2-3/16"	5/8" or 3/4"	Roller	700	Flat	4.5

- Options:** (1) 1/2", 5/8" or 3/4" Delrin Bearing. Substitute "DEL" for "RB" in model number (eg. 5200-MR-DEL)
 (2) 1/2" Flanged Ball Bearing. Substitute "BB" for "RB" in model number (eg. 4150-MR-BB)
 (3) 5/8" or 3/4" Vulcanized Rubber Seals. Add "VS" to model number (eg. 8200-MR-RB-VS)

Notes: All wheels can be supplied with Steel, Stainless Steel or Delrin Spanner Bushings. See Page 75 for complete listing.

EL SERIES ELIMINATOR GREY NON-MARKING RUBBER WHEELS

Our EL Series "Eliminator" wheel represents the ultimate evolution of the rubber wheel. This excellent wheel combines the advantages of a hard wheel for easy movement and a soft wheel for quietness and floor protection. Featuring a grey non-marking rubber tread permanently bonded to a high-impact polyolefin core, this wheel stands up to weather extremely well and resists most chemicals, oils and acids. Wheels can be steam cleaned and also reject most debris and travellers found on shop floors. Compare our capacities to most competition models and you will see the "ELIMINATOR" eliminates the need for various wheels.



6200-EL-RB



4125-EL-BB

Model Number	Wheel Size	Hub Length	Bearing Size	Bearing Type	Capacity (lbs.)	Wheel Face	Weight (Approx)
3125-EL-BB	3" X 1-1/4"	1-1/2"	3/8"	Ball Bearing	200	Flat	0.5
4125-EL-BB	4" X 1-1/4"	1-1/2"	3/8"	Ball Bearing	220	Flat	1.0
4150-EL-RB	4" X 1-1/2"	1-5/8"	5/8" or 3/4"	Roller	350	Flat	1.0
4200-EL-RB	4" X 2"	2-3/16"	5/8" or 3/4"	Roller	600	Flat	1.0
5125-EL-BB	5" X 1-1/4"	1-1/2"	3/8"	Ball Bearing	260	Flat	1.0
5150-EL-RB	5" X 1-1/2"	1-5/8"	5/8" or 3/4"	Roller	400	Flat	1.0
5200-EL-RB	5" X 2"	2-3/16"	5/8" or 3/4"	Roller	700	Flat	1.5
6150-EL-RB	6" X 1-1/2"	1-5/8"	5/8" or 3/4"	Roller	500	Flat	1.5
6200-EL-RB	6" X 2"	2-3/16"	5/8" or 3/4"	Roller	900	Flat	2.0
8200-EL-RB	8" X 2"	2-3/16"	5/8" or 3/4"	Roller	900	Flat	2.5

- Options:** (1) 1/2" Delrin Bearing (1-1/4" Face only). Substitute "DEL" for "BB" in model number (eg. 4125-EL-DEL)
 (2) 1/2", 5/8" or 3/4" Delrin Bearing (1-1/2" and 2" Face only). Substitute "DEL" for "RB" in model number (eg. 5200-EL-DEL)
 (3) 1/2" Flanged Ball Bearing. Substitute "BB" for "RB" in model number (eg. 4150-EL-BB)
 (4) 3/4" Stainless Steel Roller Bearing. Substitute "SSRB" for "RB" in model number (eg. 8200-EL-SSRB)
 (5) 5/8" or 3/4" Vulcanized Rubber Seals. Add "VS" to model number (eg. 6200-EL-RB-VS)

Notes: All wheels can be supplied with Steel, Stainless Steel or Delrin Spanner Bushings. See Page 75 for complete listing.



RMC SERIES HI-CAPACITY RUBBER MOLDON WHEELS



These solid cushion rubber tires permanently moulded onto cast steel wheel centres provide rugged, durable wheels that are widely used on industrial equipment. Their reasonable unit cost contrasted with the high cost of so called "demountable" types make moldons the most economical rubber tires wheels to buy and maintain. Tires average 1" thick and are 90A durometer (nominal) hardness to increase capacity and ease of movement over softer models.

8200-RMC-RB

Model Number	Wheel Size	Hub Length	Bearing Size	Bearing Type	Capacity (lbs.)	Wheel Face	Weight (Approx)
3150-RMC-RB	3" X 1-1/2"	1-5/8"	5/8" or 3/4"	Roller	300	Flat	2.0
4150-RMC-RB	4" X 1-1/2"	1-5/8"	5/8" or 3/4"	Roller	500	Flat	2.5
4200-RMC-RB	4" X 2"	2-3/16"	5/8" or 3/4"	Roller	700	Flat	3.0
5150-RMC-RB	5" X 1-1/2"	1-5/8"	5/8" or 3/4"	Roller	600	Flat	3.0
5200-RMC-RB	5" X 2"	2-3/16"	5/8" or 3/4"	Roller	800	Flat	3.5
6150-RMC-RB	6" X 1-1/2"	1-5/8"	5/8" or 3/4"	Roller	620	Flat	3.5
6200-RMC-RB	6" X 2"	2-3/16"	5/8" or 3/4"	Roller	900	Flat	4.0
6250S-RMC-RB	6" X 2-1/2"	2-3/4"	1" or 1-1/4"	Roller	1100	Flat	7.0
6300-RMC-RB	6" X 3"	3-1/4"	1" or 1-1/4"	Roller	1360	Flat	12.0
8200-RMC-RB	8" X 2"	2-3/16"	5/8" or 3/4"	Roller	1000	Flat	6.5
8250S-RMC-RB	8" X 2-1/2"	2-3/4"	1" or 1-1/4"	Roller	1200	Flat	10.0
8300-RMC-RB	8" X 3"	3-1/4"	1" or 1-1/4"	Roller	1680	Flat	13.0
10250S-RMC-RB	10" X 2-1/2"	2-3/4"	1" or 1-1/4"	Roller	1500	Flat	12.5
10300-RMC-RB	10" X 3"	3-1/4"	1" or 1-1/4"	Roller	2000	Flat	17.5
12300-RMC-RB	12" X 3"	3-1/4"	1" or 1-1/4"	Roller	2280	Flat	21.5

Options: (1) 1/2", 5/8" or 3/4" Delrin Bearing (1-1/2" and 2" Face only). Substitute "DEL" for "RB" in model number (eg. 5200-RMC-DEL)
 (2) 1" or 1-1/4" Delrin Bearing (2-1/2" and 3" Face only). Substitute "DEL" for "RB" in model number (eg. 8300-RMC-DEL)
 (3) 1/2" Flanged Ball Bearing (1-1/2" and 2" Face only). Substitute "BB" for "RB" in model number (eg. 4200-RMC-BB)
 (4) 5/8" or 3/4" Vulcanized Rubber Seals (1-1/2" and 2" Face only). Add "VS" to model number (eg. 8200-RMC-RB-VS)
 (5) 1" or 1-1/4" Vulcanized Rubber Seals (2-1/2" and 3" Face only). Add "VS" to model number (eg. 6250S-RMC-RB-VS)

Notes: All wheels can be supplied with Steel or Stainless Steel Bushings. See Page 75 for complete listing.

SELECTING THE RIGHT WHEEL

With so many wheel types available to choose from, it can be difficult to select the right wheel for your application. Contact our experienced sales staff to ensure that you get the wheel that will work best for you.

Here are a few general tips to help you decide what type of wheel you need:

- Larger diameter wheels roll more easily than smaller diameter wheels.
- The harder the running face of the wheel, the more easily it will roll.
- Crowned tread wheels offer better mobility than Flat tread wheels since there is less surface contact between the wheel and the floor.
- Polyurethane has a higher load bearing capacity than rubber and is much more resistant to abrasion and tearing.
- Polyurethane is available in a very broad hardness range (eraser soft to bowlingball hard)
- Polyolefin/Polypropylene/Polyethylene, Nylon or Plastic core wheels are light weight and corrosion resistant, but will carry less weight than metal hub wheels.
- Aluminum core wheels are corrosion resistant and offer greater capacity than non-metallic types, but have less capacity than Cast Steel or Ductile Iron types.
- Ductile Iron types offer higher capacities than Cast Steel and will not chip, crack or split.
- Monolithic wheels (i.e. wheels made completely from one material) are not subject to tread separation such as may occur on wheels with treads bonded to a metal, Polyolefin or plastic core.

**075-AL-BB**

This is the same smooth rolling, grey non-marking rubber wheel that comes standard in our AL and TWAL Series casters, but can be used anywhere a non-marking wheel is required. Ball bearings and thread guards are standard.

Model Number	Wheel Size	Hub Length	Bearing Size	Bearing Type	Capacity (lbs.)	Wheel Face	Weight (Approx)
050-AL-BB	2" X 3/4"	1-3/16"	5/16"	Ball Bearing	80	Flat	0.5
075-AL-BB	3" X 1"	1-3/8"	5/16"	Ball Bearing	150	Flat	0.5

Notes: Other sizes and bearing types may be available. Consult Factory.

RTC SERIES GREY DONUT NON-MARKING RUBBER WHEELS**10200C-RTC-RB**

The RTC Series wheel is made from 65A Durometer grey non-marking rubber and is ideal for institutional and light industrial use. The unique Donut style tread allows for easy swivelling as only a minor part of the tread comes in contact with the floor. Let this wheel "float" your problems away.

Model Number	Wheel Size	Hub Length	Bearing Size	Bearing Type	Capacity (lbs.)	Wheel Face	Weight (Approx)
6200C-RTC-RB	6" X 2"	2-3/16"	5/8" or 3/4"	Roller	420	Crowned	4.5
8200C-RTC-RB	8" X 2"	2-3/16"	5/8" or 3/4"	Roller	500	Crowned	6.5
10200C-RTC-RB	10" X 2"	2-3/16"	5/8" or 3/4"	Roller	650	Crowned	9.5

Options: (1) 1/2", 5/8" or 3/4" Delrin Bearing. Substitute "DEL" for "RB" in model number (eg. 6200C-RTC-DEL)
 (2) 1/2" Flanged Ball Bearing. Substitute "BB" for "RB" in model number (eg. 10200C-RTC-BB)
 (3) 5/8" or 3/4" Vulcanized Rubber Seals. Add "VS" to model number (eg. 8200C-RTC-RB-VS)

Notes: All wheels can be supplied with Steel, Stainless Steel or Delrin Spanner Bushings. See Page 75 for complete listing.

WMT SERIES METAL DISC RUBBER TREAD WHEELS**8200-WMT-RB**

These wheels are used primarily for the hand truck business. Rugged steel discs hold the solid rubber tread in place to make a strong easy rolling wheel for industrial use.

Model Number	Wheel Size	Hub Length	Bearing Size	Bearing Type	Capacity (lbs.)	Wheel Face	Weight (Approx)
6150-WMT-RB	6" X 1-1/2"	2-3/8"	3/4"	Roller	300	Flat	3.0
8200-WMT-RB	8" X 2"	2-3/8"	5/8" or 3/4"	Roller	400	Flat	4.5
10200-WMT-RB	10" X 2"	2-5/8"	3/4"	Roller	600	Flat	7.0

Notes: All wheels can be supplied with Steel, Stainless Steel or Delrin Spanner Bushings. See Page 75 for complete listing.

NL SERIES NY-LITE POLYOLEFIN WHEELS



3125-NL-P



2-NL-P

Blended from Polyolefins, our NL Series "Ny-Lite" wheels are a hard, non-marking, stain resistant wheel. This material is impervious to water and highly resistant to abrasion, impacts, and chemicals. With a temperature range from -20° F to 180° F, it is steam cleanable to meet a high standard of hygiene. This wheel has a wide range of applications in the food industry and meat processing plants.

Model Number	Wheel Size	Hub Length	Bearing Size	Bearing Type	Capacity (lbs.)	Wheel Face	Weight (Approx)
2-NL-P	2" X 3/4"	1"	1/4"	Plain	100	Flat	0.5
25-NL-P	2-1/2" X 1-1/8"	1-1/4"	5/16"	Plain	225	Flat	0.5
3125-NL-P	3" X 1-1/4"	1-1/2"	3/8" or 1/2"	Plain	275	Flat	0.5
4125-NL-P	4" X 1-1/4"	1-1/2"	3/8" or 1/2"	Plain	300	Flat	0.5
4150-NL-RB	4" X 1-1/2"	1-5/8"	5/8" or 3/4"	Roller	420	Flat	1.0
4200-NL-RB	4" X 2"	2-3/16"	5/8" or 3/4"	Roller	500	Flat	1.0
5125-NL-P	5" X 1-1/4"	1-1/2"	3/8" or 1/2"	Plain	300	Flat	0.5
5150-NL-RB	5" X 1-1/2"	1-5/8"	5/8" or 3/4"	Roller	550	Flat	1.0
5200-NL-RB	5" X 2"	2-3/16"	5/8" or 3/4"	Roller	650	Flat	1.5
6150-NL-RB	6" X 1-1/2"	1-5/8"	5/8" or 3/4"	Roller	600	Flat	1.0
6200-NL-RB	6" X 2"	2-3/16"	5/8" or 3/4"	Roller	800	Flat	1.5
8200-NL-RB	8" X 2"	2-3/16"	5/8" or 3/4"	Roller	1000	Flat	2.0

- Options:** (1) 1/2", 5/8" or 3/4" Delrin Bearing. Substitute "DEL" for "RB" in model number (eg. 5200-NL-DEL)
 (2) 1/2" Flanged Ball Bearing. Substitute "BB" for "RB" in model number (eg. 4200-NL-BB)
 (3) 3/4" Brass Flanged Bearing. Substitute "BF" for "RB" in model number (eg. 6200-NL-BF)
 (4) 3/4" Stainless Steel Roller Bearing. Substitute "SSRB" for "RB" in model number (eg. 5150-NL-SSRB)
 (5) 5/8" or 3/4" Vulcanized Rubber Seals. Add "VS" to model number (eg. 8200-NL-RB-VS)

Notes: All wheels can be supplied with Steel, Stainless Steel or Delrin Spanner Bushings. See Page 75 for complete listing.

WNL SERIES WHITE POLYOLEFIN WHEELS



5125-WNL-P

This wheel is made from the same high-performance Polyolefins as our NL Series wheels but is produced in a white colour. This makes it ideal for steam clean, cart wash and clean room environments (particularly the food industry) so dirt can clearly be seen for proper cleaning.

Model Number	Wheel Size	Hub Length	Bearing Size	Bearing Type	Capacity (lbs.)	Wheel Face	Weight (Approx)
2-WNL-P	2" X 3/4"	1"	1/4"	Plain	100	Flat	0.5
3125-WNL-P	3" X 1-1/4"	1-1/2"	3/8" or 1/2"	Plain	275	Flat	0.5
4125-WNL-P	4" X 1-1/4"	1-1/2"	3/8" or 1/2"	Plain	300	Flat	0.5
5125-WNL-P	5" X 1-1/4"	1-1/2"	3/8" or 1/2"	Plain	300	Flat	0.5
6150-WNL-RB	6" X 1-1/2"	1-5/8"	5/8" or 3/4"	Roller	600	Flat	1.0
8200-WNL-RB	8" X 2"	2-3/16"	5/8" or 3/4"	Roller	1000	Flat	2.0

- Options:** (1) 1/2", 5/8" or 3/4" Delrin Bearing. Substitute "DEL" for "RB" in model number (eg. 6150-WNL-DEL)
 (2) 1/2" Flanged Ball Bearing. Substitute "BB" for "RB" in model **number** (eg. 8200-WNL-BB)
 (3) 3/4" Brass Flanged Bearing. Substitute "BF" for "RB" in model number (eg. 6150-WNL-BF)
 (4) 3/4" Stainless Steel Roller Bearing. Substitute "SSRB" for "RB" in model number (eg. 8200-WNL-SSRB)
 (5) 5/8" or 3/4" Vulcanized Rubber Seals. Add "VS" to model number (eg. 6150-WNL-RB-VS)

Notes: All wheels can be supplied with Steel, Stainless Steel or Delrin Spanner Bushings. See Page 75 for complete listing.

These wheels, moulded from #6 Nylon, are ideal for steam cleaning and wet conditions. Their shiny white colour instantly shows dirt missed in cleaning. This material has exceptional wear and abrasion resistance, high impact strength, is lightweight, has greater load bearing capacity than Polyolefin models, is highly resistant to organic solvents and most chemicals, and can operate at temperatures from -40° F to 210° F. Perfect for use in food processing, poultry and meat packing plants.



6200-NY-RB



8200-NY-RB

Model Number	Wheel Size	Hub Length	Bearing Size	Bearing Type	Capacity (lbs.)	Wheel Face	Weight (Approx)
25-NY-P	2-1/2" X 1-1/8"	1-7/16"	5/16"	Plain	225	Flat	0.5
3150-NY-RB	3" X 1-1/2"	1-5/8"	5/8" or 3/4"	Roller	700	Flat	1.0
3200-NY-RB	3" X 2"	2-3/16"	5/8" or 3/4"	Roller	800	Flat	1.0
080-NY-P	80mm x 30mm	40mm	12mm	Plain	220	Flat	0.5
4150-NY-RB	4" X 1-1/2"	1-5/8"	5/8" or 3/4"	Roller	600	Flat	1.0
4200-NY-RB	4" X 2"	2-3/16"	5/8" or 3/4"	Roller	800	Flat	1.5
100-NY-P	100mm x 35mm	40mm	12mm	Plain	300	Flat	0.5
5150-NY-RB	5" X 1-1/2"	1-5/8"	5/8" or 3/4"	Roller	600	Flat	1.5
5200-NY-RB	5" X 2"	2-3/16"	5/8" or 3/4"	Roller	1000	Flat	1.5
125-NY-P	125mm x 40mm	46mm	15mm	Plain	350	Flat	1.0
6150-NY-RB	6" X 1-1/2"	1-5/8"	5/8" or 3/4"	Roller	800	Flat	1.5
6200-NY-RB	6" X 2"	2-3/16"	5/8" or 3/4"	Roller	1200	Flat	2.0
8200-NY-P 20mm	8" X 2"	2-3/8"	20mm	Plain	1000	Flat	2.0
8200-NY-RB 20mm	8" X 2"	2-3/8"	20mm	Roller	1000	Flat	2.0
8200-NY-RB	8" X 2"	2-3/16"	5/8" or 3/4"	Roller	1200	Flat	3.0

- Options:** (1) 1/2", 5/8" or 3/4" Delrin Bearing. Substitute "DEL" for "RB" in model number (eg. 6200-NY-DEL)
 (2) 1/2" Flanged Ball Bearing. Substitute "BB" for "RB" in model number (eg. 5150-NY-BB)
 (3) 3/4" Brass Flanged Bearing. Substitute "BF" for "RB" in model number (eg. 8200-NY-BF)
 (4) 3/4" Stainless Steel Roller Bearing. Substitute "SSRB" for "RB" in model number (eg. 6200-NY-SSRB)
 (5) 5/8" or 3/4" Vulcanized Rubber Seals. Add "VS" to model number (eg. 3200-NY-RB-VS)

Notes: All wheels can be supplied with Steel, Stainless Steel or Delrin Spanner Bushings. See Page 75 for complete listing.

NYLON vs. POLYOLEFIN WHEELS

The advantage of a white wheel is that its bright white colour readily shows up any dirt deposited on its surface. This is ideal for washdown and steam clean applications (particularly in the food industry) where it is important to ensure that carts are totally clean.

White wheels are available in both Polyolefin (WNL Series) and Nylon (NY Series) materials. Which is best for you?

Both Polyolefin and Nylon are highly resistant to most chemicals, but overall Nylon is a much higher quality material.

Not only does Nylon have a greater load bearing capacity, but it is more resistant to impact, abrasion and wear. It also has a higher tolerance to heat (210° F for Nylon vs. 180° F for Polyolefin).

PN SERIES FULL PNEUMATIC WHEELS (STEEL CENTER)



8L-PN-BB

These fully Pneumatic wheels are ideal for movement over rough surfaces or for loads that require special handling. These wheels feature a de-mountable steel centre for easy repair and replacement of tires or tubes. A variety of hub lengths, bearing types and bearing sizes are offered to suit virtually any application.

Designed for use in our PC Series Pneumatic Casters (see page 43).

Model Number	Wheel Size	Hub Length	Bearing Size	Bearing Type	Capacity (lbs.)	Hub Type	Weight (Approx)
6-PN-RB	6" X 2"	2-3/16"	3/4"	Roller	300	Symetrical	2.0
8S-PN-BB	8" X 2-1/2"	2-1/2"	1/2", 5/8" or 3/4"	Ball Bearing	300	Symetrical	3.0
8L-PN-BB	8" X 2-1/2"	3-1/4"	1/2", 5/8" or 3/4"	Ball Bearing	300	Symetrical	3.0
8L-PN-RB	8" X 2-1/2"	3-1/4"	1"	Roller	300	Symetrical	4.5
10S-PN-BB	10" X 3-1/2"	1-7/8"	1/2", 5/8" or 3/4"	Ball Bearing	350	Symetrical	4.0
10L-PN-BB	10" X 3-1/2"	4"	1/2", 5/8" or 3/4"	Ball Bearing	350	Symetrical	4.5
10-PNO-BB	10" X 3-1/2"	2-1/4"	1/2", 5/8" or 3/4"	Ball Bearing	350	Offset	4.0
10L-PN-RB	10" X 3-1/2"	4-1/4"	1"	Roller	500	Symetrical	8.0
12S-PN-BB	12" X 3-1/2"	2-1/2"	1/2", 5/8" or 3/4"	Ball Bearing	350	Symetrical	7.0
12L-PN-BB	12" X 3-1/2"	4"	1/2", 5/8" or 3/4"	Ball Bearing	350	Symetrical	7.5
12L-PN-RB	12" X 3-1/2"	4-1/4"	1"	Roller	650	Symetrical	12.0
16-PN-BB	16" X 4"	3"	1/2", 5/8" or 3/4"	Ball Bearing	500	Symetrical	7.0
16-PN-RB	16" X 4"	3"	1"	Roller	500	Symetrical	7.0
16-PN-PBB	16" X 4"	3-5/8"	30mm	Precision Ball	745	Symetrical	19.0
18-PN-TB	17-1/4" X 5-1/4"	5-1/2"	1"	Tapered	1000	Symetrical	19.5

Options: (1) 1/2", 5/8" or 3/4" Delrin Bearing. Substitute "DEL" for "BB" in model number (eg. 8L-PN-DEL)

SO SERIES SEMI-PNEUMATIC WHEELS



10275-SO-BB

These Semi-Pneumatic wheels are ideal for hand trucks or for outdoor use in garden centres or any other application that requires a light capacity, large diameter wheel. Ball bearings and offset hubs for easy mounting are standard.

Model Number	Wheel Size	Hub Length	Bearing Size	Bearing Type	Capacity (lbs.)	Hub Type	Weight (Approx)
8175-SO-BB	8" X 1-3/4"	1-3/8"	1/2"	Ball Bearing	60	Offset	2.5
8250-SO-BB	8" X 2-1/2"	2-1/4"	1/2", 5/8" or 3/4"	Ball Bearing	150	Offset	4.5
10175-SO-BB	10" X 1-3/4"	1-3/8"	1/2", 5/8" or 3/4"	Ball Bearing	80	Offset	3.0
10275-SO-BB	10" X 2-3/4"	2-1/4"	1/2", 5/8" or 3/4"	Ball Bearing	250	Offset	6.0

Notes: Other sizes and hub types may be available. Consult Factory.

BESTWAY **NEW** EAS SERIES ELASTOMER (SOLID) ANTI-STATIC WHEELS



4150-EAS-PBB

These yellow Anti-Static wheels are ideal for applications where static electricity is a problem. Moulded from special, hard Polyurethane to form an easy rolling wheel and fitted with Precision ball bearings. Highly resistant to oils, solvents, fats, greases and many chemicals. Conductivity may be affected by oil or wax build-up on floors. Wheels should be checked monthly to assure safety.

Model Number	Wheel Size	Hub Length C/W Top Hats	Axle Size	Bearing Type	Capacity (lbs.)	Wheel Face	Weight (Approx)
3150-EAS-PBB	3" X 1-1/2"	1-11/16"	5/16"	Precision Ball	500	Flat	1.0
4150-EAS-PBB	4" X 1-1/2"	1-11/16"	5/16"	Precision Ball	600	Flat	1.0
5150-EAS-PBB	5" X 1-1/2"	1-7/8"	3/8"	Precision Ball	700	Flat	1.5

Options: (1) Stainless Steel Precision Ball Bearing. Substitute "SSPBB" for "PBB" in model number (eg. 3150-EAS-SSPBB)

Notes: Custom sizes available. Consult Factory

PAL SERIES PALLET WHEELS

These heavy-duty Pallet Wheels are constructed of a hard 70D durometer (nominal) Polyurethane tread, mechanically bonded to a light and strong one-piece aluminum core. Precision ball bearings are standard to facilitate start-up.

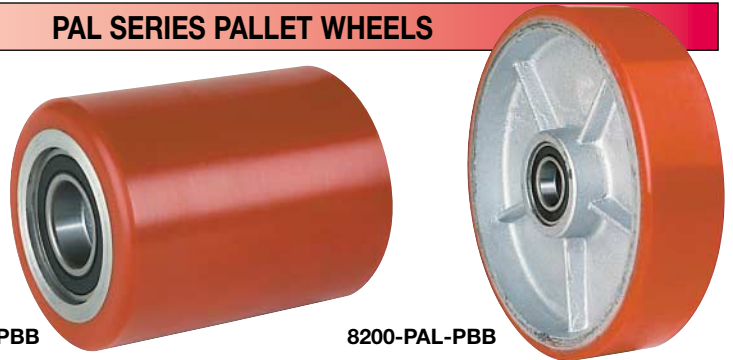

3400-PAL-PBB

8200-PAL-PBB

Model Number	Wheel Size	Hub Length	Bearing Size	Bearing Type	Capacity (lbs.)	Wheel Face	Weight (Approx)
3350-PAL-PBB	3" X 3-1/2"	3-1/2"	20mm	Precision Ball	3000	Flat	2.0
3375-PAL-PBB	3" X 3-3/4"	3-3/4"	20mm	Precision Ball	3000	Flat	2.0
3400-PAL-PBB	3" X 4"	4"	20mm	Precision Ball	3000	Flat	2.0
3254-PAL-PBB	3-1/4" X 4"	4"	20mm	Precision Ball	3000	Flat	2.5
8200-PAL-PBB	8" X 2"	2"	20mm	Precision Ball	1500	Flat	7.0

Options: (1) Can be shipped without bearings (Bore Less Bearing). Substitute 'BLB' for 'PBB' in model number (eg. 3350-PAL-BLB)

Notes: Custom sizes available. Consult Factory

Other Bearing Sizes (including Imperial sizes) may be available. Consult Factory.

NEW CW SERIES ELASTOMER CONVEYOR WHEELS

These solid Elastomer conveyor wheels are made from 70D durometer (nominal) Polyurethane with precision ball bearings moulded directly into the wheel. These wheels offer excellent abrasion resistance and durability combined with a non-marking surface that is quieter than standard steel models.



CW-58-PBB

CW-60-PBB

Model Number	Wheel Size	Hub Length	Bearing Size	Bearing Type	Capacity (lbs.)	Wheel Face	Weight (Approx)
CW-58-PBB	58mm x 20mm	12mm	20mm	Precision Ball	300	Flat	0.5
CW-60-PBB	60mm x 20mm	12mm	20mm	Precision Ball	300	Flat	0.5

Notes: Custom sizes available. Consult Factory

REPLACEMENT PARTS - BEARINGS



Roller bearings offer the best compromise between capacity, rollability and value in a bearing. Constructed with a series of hardened steel rollers encased in a split metal sleeve cover. Our standard bearing type. Made in North America.



ROLLER BEARINGS

Model Number	ID	OD	Length	Retainer Washers			Thrust Washer
				Steel	Nylon	Double Nylon	
RB-12125	1/2"	1-1/16"	1-1/8"	RW-12116	NW-12116		TW-12
RB-58150	5/8"	1-3/16"	1-3/8"	RW-34136	NW-34136	DW-34136	TW-58
RB-34150	3/4"	1-3/16"	1-3/8"	RW-34136	NW-34136	DW-34136	TW-34
RB-34178	3/4"	1-3/16"	1-7/8"	RW-34136	NW-34136	DW-34136	TW-34
RB-58200	5/8"	1-3/16"	2"	RW-34136	NW-34136	DW-34136	TW-58
RB-34200	3/4"	1-3/16"	2"	RW-34136	NW-34136	DW-34136	TW-34
RB-10200	1"	1-7/16"	2"	RW-10176			TW-10
RB-10250	1"	1-15/16"	2-1/2"	RW-10115			TW-10
RB-14250	1-1/4"	1-15/16"	2-1/2"	RW-14115			TW-14
RB-10300	1"	1-15/16"	3"	RW-10115			TW-10
RB-14300	1-1/4"	1-15/16"	3"	RW-14115			TW-14
RB-14400	1-1/4"	2-7/16"	4"	RW-14276			TW-14
RB-15400	1-1/2"	2-7/16"	4"	RW-15276			TW-15
RB-14500	1-1/4"	2-7/16"	5"	RW-14276			TW-14
RB-15500	1-1/2"	2-7/16"	5"	RW-15276			TW-15



An improved version of our standard roller bearing featuring a solid outer sleeve for simplified installation and improved grease retention. Made in North America.



A fully stainless steel version of our standard roller bearing. Provides higher capacity and improved rollability over Delrin Bearings.

1-PIECE HEAVY DUTY ROLLER BEARINGS

Model Number	ID	OD	Length
HRB-58150	5/8"	1-3/16"	1-3/8"
HRB-34150	3/4"	1-3/16"	1-3/8"
HRB-34178	3/4"	1-3/16"	1-7/8"

STAINLESS STEEL ROLLER BEARINGS (ALL STAINLESS)

Model Number	ID	OD	Length
SSRB-34150	3/4"	1-3-16"	1-3/8"
SSRB-34200	3/4"	1-3-16"	2"
SSRB-10300	1"	1-15/16"	3"



A one-piece insert bearing constructed from Delrin material. Our standard bearing for use with stainless steel casters where a cam style brake is used.

ONE PIECE DELRIN BEARINGS

Model Number	ID	OD	Length
DB-12150	1/2"	1-3/16"	1-5/8"
DB-58150	5/8"	1-3/16"	1-5/8"
DB-34150	3/4"	1-3/16"	1-5/8"
DB-12200	1/2"	1-3/16"	2-1/8"
DB-58200	5/8"	1-3/16"	2-1/8"
DB-34200	3/4"	1-3/16"	2-1/8"
DB-10200	1"	1-7/16"	2"
DB-10250	1"	1-15/16"	2 @ 1-1/4"
DB-14250	1-1/4"	1-15/16"	2 @ 1-1/4"
DB-10300	1"	1-15/16"	2 @ 1-1/2"
DB-14300	1-1/4"	1-15/16"	2 @ 1-1/2"

SELECTING THE RIGHT BEARING

Finding the right caster for your application involves more than just picking the fork and wheel types. The bearing you select for your wheel has a great impact on the overall performance of your caster.

- For improved rollability select Flanged Ball Bearings, Precision Ball Bearings, or Tapered Roller Bearings.
- For increased capacity select Tapered Roller Bearings or Precision Ball Bearings.
- Wet conditions call for Delrin Bearings, Stainless Roller Bearings or Stainless Precision Ball Bearings.
- High Heat applications require either Flanged Brass Bearings or Hi-Lex Spanner Bushings.
- Precision Ball Bearings or Tapered Roller Bearings are required for Towline applications.

Remember, whatever bearing you choose, proper regular maintenance is required to keep it working!



Flanged roller bearings are a higher capacity alternative to flanged ball bearings such as those found on our pneumatic and semi-pneumatic wheels. Made in North America.



Flanged brass bearings are ideal for high-heat or corrosive environments or for wet applications where Delrin bearings are inappropriate. Made in North America.

FLANGED ROLLER BEARINGS

Model Number	ID	OD	Length
RF-58138	5/8"	1-3/8"	1"
RF-34138	3/4"	1-3/8"	1"

FLANGED BRASS BEARINGS

Model Number	ID	OD	Length
BF-34136	3/4"	1-3/16"	5/8"
BF-10115	1"	1-15/16"	1-3/8"



Delrin is a high-strength, wear resistant material with a low coefficient of friction. This combined with good chemical resistance and low moisture absorption make it ideal for use as a wheel bearing. This is our standard stainless bearing. One-piece Delrin bearings are required when a cam-style brake (BR) is used.



Flanged ball bearings provide improved rollability over standard roller bearings however load capacity is reduced.

FLANGED DELRIN BEARINGS

Model Number	ID	OD	Length
DF-12118	1/2"	1-1/8"	1/2"
DF-12136	1/2"	1-3/16"	11/16"
DF-58136	5/8"	1-3/16"	11/16"
DF-34136	3/4"	1-3/16"	11/16"
DF-12138	1/2"	1-3/8"	5/8"
DF-58138	5/8"	1-3/8"	5/8"
DF-34138	3/4"	1-3/8"	5/8"

FLANGED BALL BEARINGS

Model Number	ID	OD	Length
BB-38118	3/8"	1-1/8"	13/16"
BB-12136	1/2"	1-3/16"	7/16"
BB-12138	1/2"	1-3/8"	1/2"
BB-58138	5/8"	1-3/8"	1/2"
BB-34138	3/4"	1-3/8"	1/2"



Our fully sealed precision ball bearings (available in both steel and stainless steel) provide both greatly increased rollability and higher capacity over roller bearings. PBB's are ideal for towline applications.

PRECISION BALL BEARINGS

Model Number	ID	OD	Seal Type
PBB-6203-2RS	17mm	40mm	Rubber
PBB-6204-2RS	20mm	47mm	Rubber
PBB-6205-2RS	25mm	52mm	Rubber

STAINLESS PRECISION BALL BEARINGS

Model Number	ID	OD	Seal Type
SSPBB-6203-2RS	17mm	40mm	Rubber
SSPBB-6205-2RS	25mm	52mm	Rubber



Our precision machined Top Hat spacers are designed for use with precision ball bearings.

TOP HATS (SPACERS FOR PRECISION BALL BEARINGS)

Model Number	ID	Typical Wheel Hub Length
TH-56	5/16"	1-5/8" (1-11/16" Leg Spacing)
TH-38	3/8"	1-5/8" (1-7/8" Leg Spacing)
TH-12	1/2"	2-3/16" (2-7/16" Leg Spacing)
TH-34S	3/4"	2-3/4" (3" Leg Spacing)
TH-34L	3/4"	3-1/4" (3-1/2" Leg Spacing)
TH-34XL	3/4"	2-3/4" (3-1/2" Leg Spacing)

TOP HATS (SPACERS FOR PRECISION BALL BEARINGS)

Model Number	ID	Typical Wheel Hub Length
SSTH-38	3/8"	1-5/8" (1-7/8" Leg Spacing)
SSTH-12	1/2"	2-3/16" (2-7/16" Leg Spacing)
SSTH-34S	3/4"	2-3/4" (3" Leg Spacing)
SSTH-34L	3/4"	3-1/4" (3-1/2" Leg Spacing)
SSTH-34XL	3/4"	2-3/4" (3-1/2" Leg Spacing)

Tapered roller bearings offer both much higher load bearing capacity and improved rollability over standard roller bearings. They are suitable for towline applications.



Vulca seals are a rubberised version of our standard steel retainer washers and are used to provide a seal for our standard roller bearings.

TAPERED ROLLER BEARINGS

Model Number	ID	Typical Installation
TB-12	1/2"	Most 1-3/16" Bore Wheels
TB-34	3/4"	Most 1-15/16" Bore Wheels
TB-10	1"	Most 1-15/16" Bore Wheels
TB-14	1-1/4"	Most 2-7/16" Bore Wheels
TB(HD)-14	1-1/4"	Most 2-7/16" Bore Wheels
TB-15	1-1/2"	Most 2-7/16" Bore Wheels
TB-20	2"	Most 2-7/16" Bore Wheels

VULCA SEALS

Model Number	ID	OD	Thickness
VS-34136	3/4"	1-3/16"	3/32"
VS-58136	5/8"	1-3/16"	3/32"
VS-10115	1"	1-15/16"	1/8"
VS-14115	1-1/4"	1-15/16"	1/8"
VS-14276	1-1/4"	2-7/16"	1/8"
VS-15276	1-1/2"	2-7/16"	1/8"



Retainer washers are used to firmly hold roller bearings in place in the wheel. They are available in steel, nylon or stainless steel.



Head seals are soft gaskets used to seal the raceways on a caster to prevent infiltration of debris.

HEAD SEALS

Model Number	Series Used With
HS-BW	BW, RT, SSBW and SSRT Series
HS-HD	HD, LH, SSHD and SSLH Series
HS-LD	LD and SSLD Series
HS-LS	LE, LS, SSLE and SSLS Series

STEEL RETAINER WASHERS

Model Number	ID	OD
RW-12116	1/2"	1-1/16"
RW-34136	3/4"	1-3/16"
RW-10176	1"	1-7/16"
RW-10115	1"	1-15/16"
RW-14115	1-1/4"	1-15/16"
RW-14276	1-1/4"	2-7/16"
RW-15276	1-1/2"	2-7/16"

NYLON RETAINER WASHERS

Model Number	ID	OD
NW-12116	1/2"	1-1/16"
NW-34136	3/4"	1-3/16"

STAINLESS STEEL RETAINER WASHERS

Model Number	ID	OD
SSRW-34136	3/4"	1-3/16"
SSRW-10115	1"	1-15/16"

DOUBLE NYLON RETAINER WASHERS

Model Number	ID	OD
DW-34136	3/4"	1-3/16"

STEEL THRUST WASHERS

Model Number	ID
TW-12	1/2"
TW-58	5/8"
TW-34	3/4"
TW-10	1"
TW-14	1-1/4"
TW-15	1-1/2"

STAINLESS STEEL THRUST WASHERS

Model Number	ID
SSTW-12	1/2"
SSTW-34	3/4"
SSTW-10	1"

WASHERS AND TOP HATS - SELECTION AND INSTALLATION GUIDE

Different bearing types require different combinations of washers to ensure proper operation of the wheel. Here is a brief guide:

- Retainer Washers are used to "retain" or hold in place Roller Bearings (standard, 1-piece and stainless steel).
- Thrust Washers are used in conjunction with Retainer Washers to keep the Caster fork legs from compressing against the side of the wheel.
- Double Nylon Washers are a combination Retainer Washer and Thrust Washer together in one piece.
- Flanged bearings (Delrin, Flanged Brass, Flanged Roller and Flanged Ball) and Tapered Roller Bearings do not require washers to be installed.
- Casters using Cam Style Pedal Brakes (BR) must use separate Retainer and Thrust Washers (rather than Double Nylon Washers) to operate.
- Precision Ball Bearings require the use of Top Hat Spacers.

Spanner bushings are used to “span” the distance between the legs of the fork. The Spanner is locked in place allowing the bearing to turn freely. Precision machined and cross-drilled to allow for lubrication of the wheel bearing.



A fully stainless steel version of our standard steel spanner bushing.

STEEL SPANNER BUSHINGS

Model Number	ID	OD	Length
SB-5638112	5/16"	3/8"	1-1/2"
SB-5638196	5/16"	3/8"	1-9/16"
SB-5612196	5/16"	1/2"	1-9/16"
SB-5658111	5/16"	5/8"	1-11/16"
SB-56RM178	5/16"	12mm	1-7/8"
SB-3812196	3/8"	1/2"	1-9/16"
SB-3812178	3/8"	1/2"	1-7/8"
SB-3858111	3/8"	5/8"	1-11/16"
SB-3858178	3/8"	5/8"	1-7/8"
SB-1258178	1/2"	5/8"	1-7/8"
SB-1258276	1/2"	5/8"	2-7/16"
SB-1234178	1/2"	3/4"	1-7/8"
SB-1234276	1/2"	3/4"	2-7/16"
SB-1210300	1/2"	1"	3"
SB-1210312	1/2"	1"	3-1/2"
SB-5834178	5/8"	3/4"	1-7/8"
SB-5834276	5/8"	3/4"	2-7/16"
SB-5810300	5/8"	1"	3"
SB-5810312	5/8"	1"	3-1/2"
SB-3410300	3/4"	1"	3"
SB-3410312	3/4"	1"	3-1/2"
SB-1014312	1"	1-1/4"	3-1/2"
SB-1014412	1"	1-1/4"	4-1/2"
SB-1415312	1-1/4"	1-1/2"	3-1/2"
SB-1415412	1-1/4"	1-1/2"	4-1/2"

CUSTOM COMPONENTS

Bestway has it's own in-house machine shop where we can quickly manufacture any custom replacement part or component you may require.

If you require a component that is not listed on these pages, give us the specifications and we can make it for you. As with all of our custom specials, we offer speedy delivery and unbeatable pricing. There is no minimum order quantity required.

Here's just a sample of the custom products we can produce for you:

- Axle Kits (Plain and Grease)
- Spanner Bushings
- Top Hat Spacers for PBB's
- Flanged Metal Bearings

We can machine your product in the material of your choice (Steel, Stainless Steel, Brass, Bronze, Delrin).

We can also source non-standard bearing types and sizes to suit your specific application needs.

STAINLESS STEEL SPANNER BUSHINGS

Model Number	ID	OD	Length
SSB-5612M111	5/16"	12mm	1-11/16"
SSB-5612196	5/16"	1/2"	1-9/16"
SSB-5658111	5/16"	5/8"	1-11/16"
SSB-5634111	5/16"	3/4"	1-11/16"
SSB-5612M178	5/16"	12mm	1-7/8"
SSB-3812196	3/8"	1/2"	1-9/16"
SSB-3815M178	3/8"	15mm	1-7/8"
SSB-3858111	3/8"	5/8"	1-11/16"
SSB-3858178	3/8"	5/8"	1-7/8"
SSB-3834111	3/8"	3/4"	1-11/16"
SSB-3834178	3/8"	3/4"	1-7/8"
SSB-1234178	1/2"	3/4"	1-7/8"
SSB-1234276	1/2"	3/4"	2-7/16"
SSB-3410300	3/4"	1"	3"
SSB-3410312	3/4"	1"	3-1/2"

These spanners are made from high-strength Delrin material and are a lower cost alternative to stainless steel spanner bushings.

DELRIN SPANNER BUSHINGS

Model Number	ID	OD	Length
DSB-5612196	5/16"	1/2"	1-9/16"
DSB-3812158	3/8"	1/2"	1-5/8"
DSB-1234178	1/2"	3/4"	1-7/8"
DSB-1234276	1/2"	3/4"	2-7/16"

These special spanner bushings are designed to allow wheels to turn through the expansion and contraction often experienced in high-heat applications that cause other bearings to squeak and bind. They are intended for use with our special High-Temp Monolithic Wheels (HTM Series).

HI-LEX SPANNER BUSHINGS

Model Number	ID	OD	Length
HL-56	5/16"	12mm	1-5/8"
HL-38	3/8"	15mm	1-7/8"

REPAACEMENT PARTS - AXLE KITS



Grease axles are hollow axles that are fitted with a grease nipple to allow periodic lubrication of the wheel bearing.



Plain axles (without grease fittings) are used with spanners and bearings that do not require lubrication.

GREASE AXLE KITS

Model Number	Diam.	Length
GAK-56214	5/16"	2-1/4"
GAK-56212	5/16"	2-1/2"
GAK-38214	3/8"	2-1/4"
GAK-38212	3/8"	2-1/2"
GAK-38300	3/8"	3"
GAK-12300	1/2"	3"
GAK-12312	1/2"	3-1/2"
GAK-12400	1/2"	4"
GAK-12412	1/2"	4-1/2"
GAK-12500	1/2"	5"
GAK-12512	1/2"	5-1/2"
GAK-12612	1/2"	6-1/2"
GAK-34412	3/4"	4-1/2"
GAK-34500	3/4"	5"
GAK-34512	3/4"	5-1/2"
GAK-34900	3/4"	9"
GAK-10512	1"	5-1/2"
GAK-14612	1-1/4"	6-1/2"
GAK-14700	1-1/4"	7"
GAK-14130	1-1/4"	13"

PLAIN AXLE KITS

Model Number	Diam.	Length
AK-25112	1/4"	1-1/2"
AK-25134	1/4"	1-3/4"
AK-25200	1/4"	2"
AK-56200	5/16"	2"
AK-56214	5/16"	2-1/4"
AK-56212	5/16"	2-1/2"
AK-38214	3/8"	2-1/4"
AK-38212	3/8"	2-1/2"
AK-38300	3/8"	3"
AK-12300	1/2"	3"
AK-12312	1/2"	3-1/2"
AK-12400	1/2"	4"
AK-12412	1/2"	4-1/2"
AK-12500	1/2"	5"
AK-12512	1/2"	5-1/2"
AK-12612	1/2"	6-1/2"
AK-34412	3/4"	4-1/2"
AK-34500	3/4"	5"
AK-34512	3/4"	5-1/2"
AK-34900	3/4"	9"
AK-10512	1"	5-1/2"
AK-14612	1-1/4"	6-1/2"
AK-14700	1-1/4"	7"
AK-14912	1-1/4"	9-1/2"
AK-14130	1-1/4"	13"

A fully stainless steel version of our standard plain axles.

STAINLESS STEEL PLAIN AXLE

Model Number	Diam.	Length
SSAK-56214	5/16"	2-1/4"
SSAK-38212	3/8"	2-1/2"
SSAK-12300	1/2"	3"
SSAK-12312	1/2"	3-1/2"
SSAK-34412	3/4"	4-1/2"
SSAK-34500	3/4"	5"



A fully stainless steel version of our standard grease axles.

STAINLESS STEEL GREASE AXLE

Model Number	Diam.	Length
SSGAK-56214	5/16"	2-1/4"
SSGAK-38212	3/8"	2-1/2"
SSGAK-12300	1/2"	3"
SSGAK-12312	1/2"	3-1/2"
SSGAK-34412	3/4"	4-1/2"
SSGAK-34500	3/4"	5"

CHOOSING THE RIGHT AXLE KIT

There are several things to consider when selecting an Axle kit.

- The Diameter of the Axle is determined by the Axle hole size of the caster being used.
- The Length of the Axle is determined by the fork leg spacing of the caster used. On some light duty casters a slightly longer axle may be required if a Side Pedal Brake is installed.
- Stainless Steel material should be used with all Stainless Steel casters regardless of bearing type or material.
- Plain Axles should be used where there is no requirement to lubricate the wheel bearing (i.e. Plain Bore, Flanged Ball Bearings, Flanged Roller Bearings and Precision Ball Bearings).
- Grease Axles are used where periodic lubrication of the wheel bearing is required (i.e. Roller Bearings, Delrin Bearings, 1-Piece Heavy Duty Roller Bearings, Stainless Steel Roller Bearings and Tapered Roller Bearings).

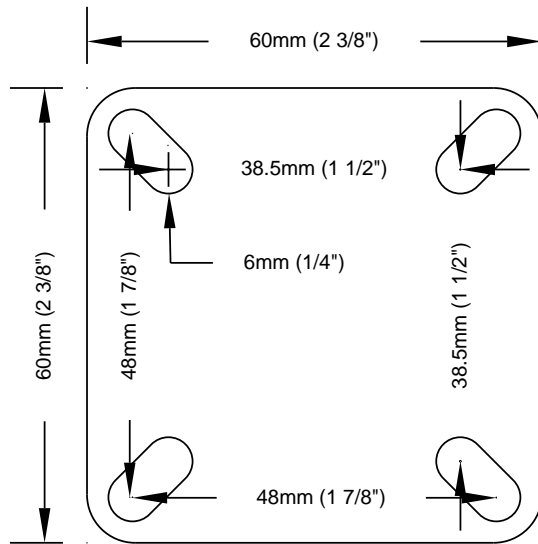

**AL-50-FTP
TWAL-50-FTP &
TWAL-75-FTP
TOP PLATE**

