

Forney

Metal-Working Products and Accessories Catalogue

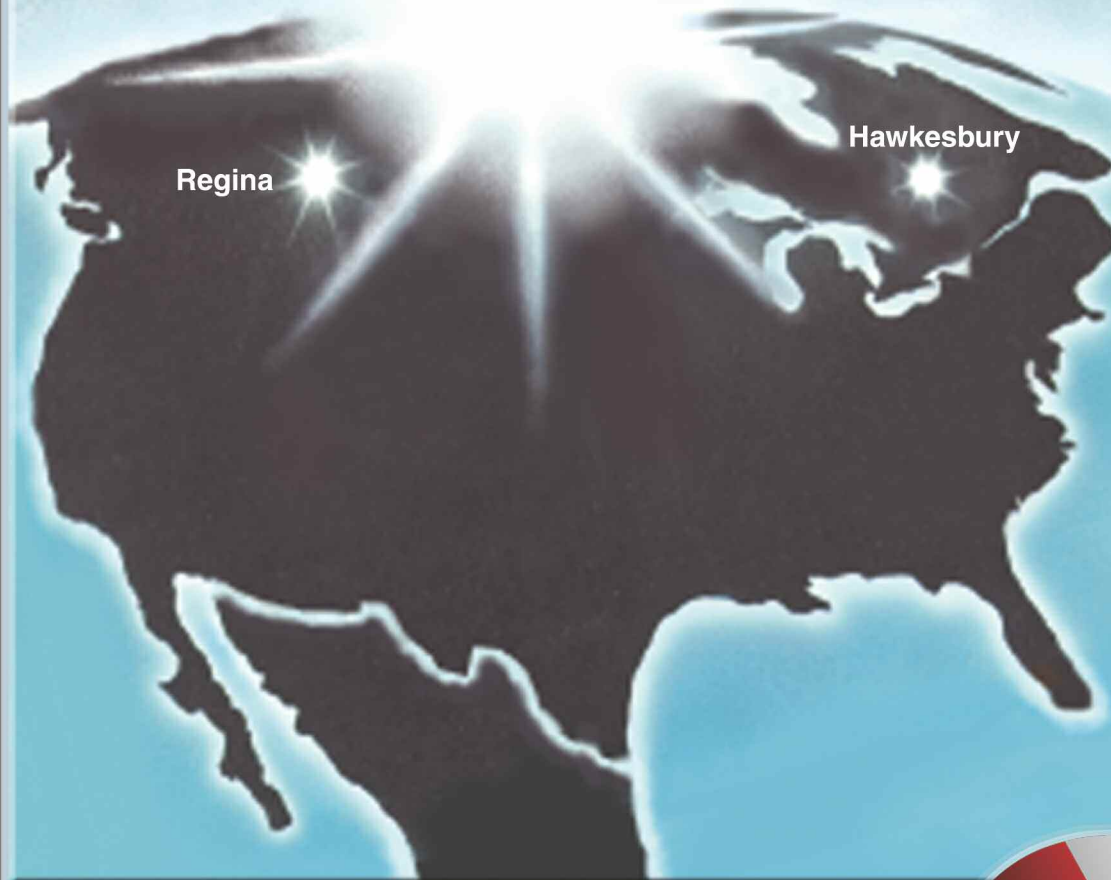

Abrasives

Air Accessories

***Pressure Washer
Accessories***

Utility Hardware

Springs

Files

Gloves

Mig Wire & Solder

Jumper Cables

Micro-Abrasives

Safety Products

Welding

Accessories

Electrodes

Torches

Helmets

Effective January 2012





Welding and Metalworking Products & Supplies

Head Office

140 - 5th Ave. E.
Regina, Sask.
S4N 5A1
Phone: (306) 569-9083
Fax: (306) 565-3177

Eastern Warehouse

1375 Tessier Street
Hawkesbury, Ont.
K6A 3S6
Phone: (613) 632-2205
Fax: (613) 632-8152

DEALER CATALOGUE

Effective January 2012

Supersedes All Previous Catalogues and Supplements

-----TERMS AND CONDITIONS OF SALES -----

PRICES: Prices are subject to change without notice and prices in effect at the time of shipment will apply. G.S.T. will be charged in addition to the prices published in our Price List.

TERMS: Shipment will be on an open basis upon proper credit relations as determined by the Company. All billings are **NET 30 DAYS** from the date of shipment. Please pay from invoice.

TRANSPORTATION: Orders placed that meet with current company policy will be shipped **PREPAID** please contact our office for more information.

CANCELLATIONS: Shipper must receive notice 24 hours prior to shipment. Shipments executed and then cancelled will be treated as Returned Goods.

RETURN POLICY: Our Representatives do not work from warehouses and ARE NOT AUTHORIZED to pick up any merchandise. All returned goods are to be shipped to the Regina Warehouse via **PREPAID FREIGHT**. Any goods returned via **COLLECT FREIGHT** will have all applicable charges deducted from the overall credit. To assure proper credit and/or handling, please request prior authorization from the Regina Office before shipping the merchandise.

WARRANTY: Merchandise may not be returned for credit, replacement or warranty repairs unless authorized by the Regina Office. **UNAUTHORIZED RETURNED GOODS OR COLLECT FREIGHT SHIPMENTS WILL NOT BE ACCEPTED FOR CREDIT.**

CANCELLATION POLICY: All goods out of stock at the time of shipment will be cancelled and must be reordered by the customer. Only equipment and bulk/case lot items ordered and not shipped will be Back Ordered.

DAMAGED SHIPMENT - SHORTAGES: Claims by the buyer for goods damaged or lost in transit will be directed to the Freight Carrier. The shipper's responsibilities end upon delivery of goods to the carrier. Any shortages on orders must be claimed for within **7 days** of receipt of goods by the purchaser.

OBSOLESCENCE POLICY: An unlimited first year annual return will be accepted, freight prepaid, without a restocking charge if the items returned do not require repackaging. An offsetting order of equal value is required.

Subsequent annual returns are limited to 2% of the previous year's purchases and will be accepted, freight prepaid, without a restocking charge if the items do not require repackaging. Any items in excess of 2% or items that are less than standard pack, or items that require repackaging will be subject to a restocking charge.

SPECIAL ORDERS: "Special Order" product(s) not stocked by Forney are **NON-RETURNABLE**.

**RESTOCKING CHARGE ON
PRODUCT RETURNED FOR CREDIT**

PAINT MARKERS



70816

70817
ONE QUART OPENING INVENTORY
 Contains the following items.

5 ea.	70818	WHITE
5 ea.	70819	BLACK
3 ea.	70820	RED
2 ea.	70821	BLUE
3 ea.	70822	YELLOW
2 ea.	70823	GREEN
2 ea.	70824	SILVER
2 ea.	70825	ORANGE

To refill displays, order by individual item number.

70818	WHITE
70819	BLACK
70820	RED
70821	BLUE
70822	YELLOW
70823	GREEN
70824	SILVER
70825	ORANGE

- Fast drying oil based paint.
- Precision valve action controls paint flow.
- Long bullet nib.
- 9/16" easy grip aluminum tube.
- 6 standard colors.

INDUSTRIAL PAINT MARKERS

Ideal for permanent marking and coding on a wide variety of surfaces, with excellent resistance to abrasion, water, sunlight and rough handling. Sold individually or in two convenient starter packages.

70816
LARGE OPENING INVENTORY & DISPLAY
 CONTAINS THE FOLLOWING ITEMS.

10 ea.	70818	WHITE
10 ea.	70819	BLACK
6 ea.	70820	RED
6 ea.	70821	BLUE
6 ea.	70822	YELLOW
4 ea.	70823	GREEN
3 ea.	70824	SILVER
3 ea.	70825	ORANGE

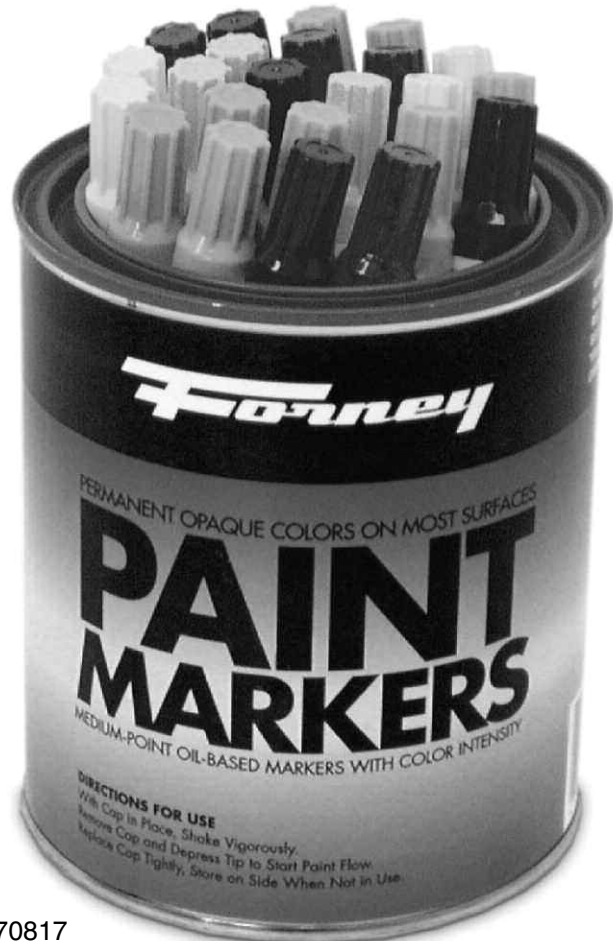

70817

POLY FLEX AIR HOSE

LIGHTER and FLEXIBLE

This hose weighs up to 50% less and is more flexible than rubber.

REPAIR IN THE FIELD

Hose Splicers Available for On - The - Spot Repairs. No Clamps Needed.

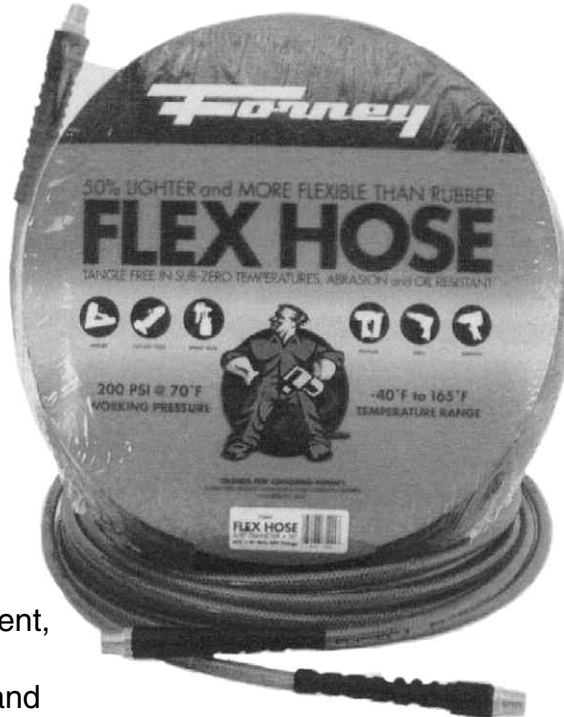

TANGLE FREE

Regardless of Environment, the Poly Flex Air Hose Remains Tangle - Free and Kink - Resistant.

WEATHER PROOF

The Temperature Range -40° to 165° F Means This New Flex Hose Handles any Environment. (200psi @ 70° F)

MADE IN U.S.A.

TsP TOTAL SUPPORT PROGRAM

AIR HOSE

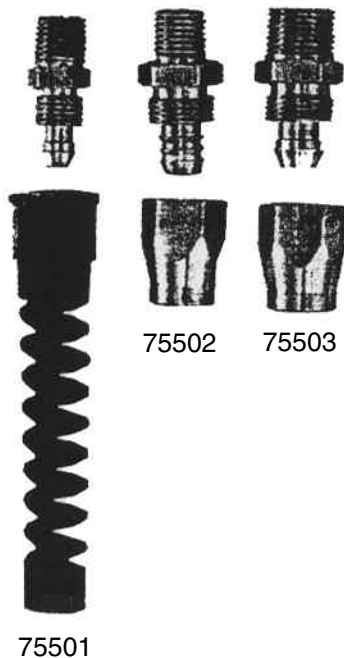

75442	1/4" x 50 FT. POLYFLEX AIR HOSE
75443	1/4" x 100 FT. POLYFLEX AIR HOSE
75444	3/8" x 50 FT. POLYFLEX AIR HOSE
75445	3/8" x 100 FT. POLYFLEX AIR HOSE
75450	1/4" x 25 FT POLYFLEX AIR HOSE ASSEMBLY
75451	3/8" x 25 FT. POLYFLEX AIR HOSE ASSEMBLY
75455	1/4" POLYFLEX AIR HOSE BULK.
75456	3/8" POLYFLEX AIR HOSE BULK.
75498	FLEX HOSE 1/4" SPLICER.
75499	FLEX HOSE 3/8" SPLICER.
75501	STRAIN RELIEF W / 1/4"
75502	3/8" ID x RIGID 1/4" MPT
75503	3/8" ID x RIGID 3/8" MPT

MIG WELDING EQUIPMENT & ACCESSORIES

85358

ARGON GAS REGULATOR KIT

For small to medium size Mig welders. Includes 85359 Adapter



85359

GAS LINE ADAPTER

For 85363 Argon/CO²Regulator & other mig systems with 1/8" gas hose (WE 6650)

85372

TORCH NECK WITH GAS DIFFUSER

(WE 6574). Only for Older Clarke Welders using 5/8" long Tips.



85376

TORCH NECK WITH GAS DIFFUSER

(WE7010) For Current Clarke Welders using 1" Long Tips



85377

WIRE LINER FOR TORCH NECK

(WE7012) For Current Clarke Welders using 1" Long Tips



MIG LINERS FOR ALL MODELS OF 310, 312, 313, 315 & 316 CLARKE UNITS

6' Long. Teflon Recommended for Aluminum wire.

85355 Steel (WE 7001)



**85336 TWECO NOZZLE (#21-50F)
BORE SIZE 1/2" OR 12.7mm**

1/2" gas concentration nozzle fits Tweco & Clarke style Mig guns and is suitable for medium duty applications.



**85337 TWECO NOZZLE (#21-62F)
BORE SIZE 5/8" OR 15.9mm**

5/8" gas concentration nozzle fits Tweco style Mig guns. Suitable for medium to heavy duty applications.



**85338 TWECO SPOTWELD NOZZLE
BORE SIZE 5/8" OR 15.9 mm**

5/8" spot welding nozzle can convert certain Mig welders into instant spot welders.



85339

TWECO GAS DIFFUSER

Replacement gas diffuser efficiently disperses shielding gases for smooth, spatter-free welding on Tweco style Mig guns.



85333

BINZEL SPOTWELD NOZZLE

BORE SIZE 5/8" / 16 mm

Handy 5/8" spot welding nozzle converts Mig welders into instant spot welders.



85378

NEW! TORCH NOZZLE WITH INSULATOR

BORE SIZE 7/16" (WE 6541)

For Current Forney/Clarke Mig welders

MIG WELDER REPAIR ACCESSORIES AND PARTS



MIG WELDING EQUIPMENT & ACCESSORIES

MIG TIPS, NOZZLES AND TIGER TORCHES

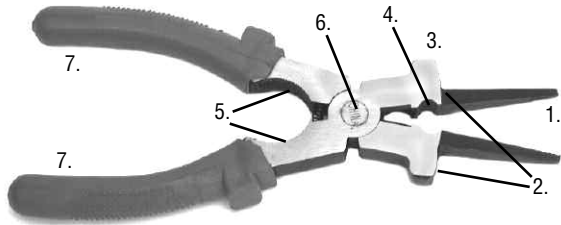
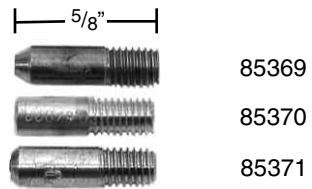
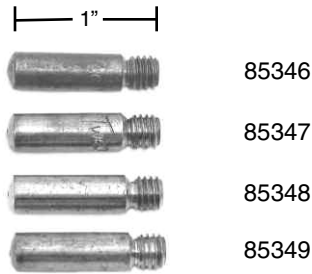

NEW! HOBART MIG REPAIR PARTS

For Handler 135, 175 and Ironman 210, 250.

12 / Bag	4 / Card	
85365	60164Contact Tip-.023/.025
85366	60165Contact Tip-.030
85367	60166Contact Tip-.035
85368	60167Contact Tip-.045

60160Nozzle-1/2"
60161Nozzle-5/8"

1" CONTACT TIPS FOR TWECO/BINZEL MIG GUNS & CURRENT CLARKE UNITS

Precision machined contact tips designed to replace either Tweco or Binzel gun tips. Each or 4 per card.

12 / Bag	4 / Card	Clark #
85346	60170	WE 6514Tweco or Binzel .023 (0.6mm)
85347	60171	WE 6515Tweco or Binzel .030 (0.8mm)
85348	60172	WE 6625Tweco or Binzel .035 (0.9mm)
85349	60173	WE 6525Tweco or Binzel .045 (1.2mm)

5/8" CONTACT TIPS FOR MOST OLDER STYLE CLARKE MIG GUNS

Precision machined contact tips are designed to replace Forney or Clarke Mig gun tips each or 4/card.

12 / Bag	4 / Card	Clark #
85369	60176	WE6539035 (.9mm)
85370	60177	WE6542023 (.6mm)
85371	60178	WE6543030 (.8mm)

85801• MIG PLIERS DOES SEVEN JOBS FOR MIG WELDING

1. Needle nose gripper for pulling
2. Small serrated hole for mig tips
3. Flat surfaces for hammering
4. Cutter to trim mig wire
5. Large serrated hole for nozzle
6. Spring loaded handle
7. Heavy insulated comfort grip.



Three hose lengths Available

3410	10 ft. Hose
3415	15 ft. Hose
3420	20 ft. Hose

208,000 B.T.U. at 30 lbs. P.S.I



Great for thawing frozen pipes and valves, Preheating steel and pipe for welding, Burning weeds, Heating Pots Kettles, Branding irons and any other applications requiring intense heat.

WELDING ELECTRODES AND ROD



6011 WELDING ELECTRODE (VERTICAL&OVERHEAD)

COLOR CODE: YELLOW LABEL- A mild steel, general purpose, all position electrode with stable arc characteristics and deep penetration. Use on AC or DC reverse polarity welding current. Fast freezing or rapid solidification of weld metal facilitates welding in vertical or overhead positions.

- High Penetrating, All Purpose Electrode
- Fence or Post Fabrication/Repairs
- Welding Through Medium Amounts of Paint, Rust, Dirt

Size	Catalogue # / pounds		
	1 lb.	5 lbs.	10 lbs.
3/32"	41101	31105	-
1/8"	41201	-	31210
5/32"	41301	-	31310

6013 WELDING ELECTRODE (GENERAL PURPOSE)

COLOR CODE: RED LABEL-A mild steel, general purpose, all position electrode. Use AC or DC (straight or reverse polarity) welding current. Especially useful for welding where poor fit-up conditions (wide gaps) exist. Small sizes are well suited for welding thin materials where low heat input required.

- Light to Medium Penetrating, All Purpose Electrode
- Ideal for Use on Weld Joints With Poor Fit-ups
- Use on Light Gauge Metal Sheet Metal and Duct Work
- For Metal Buildings and Structures

Size	Catalogue # / pounds		
	1 lb.	5 lbs.	10 lbs.
1/16"	40102	-	-
5/64"	40201	1/2 lbs.	-
5/64"	40202	-	-
3/32"	40301	30305	-
1/8"	40401	-	30410
5/32"	40501	-	30510

7014 WELDING ELECTRODE (HIGH DEPOSITION)

COLOR CODE: ORANGE LABEL- A mild steel, all position iron powder electrode. Designed to increase deposition rates and welding speeds. Provides good arc stability, low spatter and produces medium to low penetration. Can be used on AC or DC (straight or reverse polarity) welding current.

- Light to Medium Penetrating, All Purpose Electrode
- Use Where Higher Deposition Rates & Faster Travel Speeds Are Required
- For Heavy Sheet Metal
- Smooth, Fine-Rippled Bead Appearance

Size	Catalogue # / pounds		
	1 lb.	5 lbs.	10 lbs.
3/32"	42001	32005	-
1/8"	42101	-	32110
5/32"	42201	-	32210

ELECTRODES AND STORAGE CONTAINERS

FORNEY AC 7018 WELDING ELECTRODE (High Strength - Low Hydrogen)

COLOR CODE: LIGHT BLUE & RED LABEL-A low hydrogen 7018 electrode designed for smaller 208/230 volt, single phase AC welders. Provides a smooth, stable arc. Has excellent restart capabilities. Designed for welding low, medium and high carbon steels and some higher strength low-alloy steels.

- Designed to Be Used With Smaller 208/230 Volt AC Welders
- Low Hydrogen Electrode For Low, Medium and High Carbon Steels

Size	Catalogue # / pounds		
	1 lb.	5 lbs	10 lbs
3/32"	40680	30681	-
1/8"	40684	-	30686
5/32"	40688	-	30690

- For Frames, Trailer Hitches and Chassis
- For High Strength (70,000 PSI Min. Tensile Strength) Welding Requirements

FORNEY 7018 WELDING ELECTRODE

COLOR CODE: PALE BLUE LABEL-A low hydrogen iron powder type electrode that produces X-Ray quality welds in all positions. Works best on DC reverse polarity welding current, providing excellent start and restart capabilities. Used in applications where higher strength and resistance to cracking is required.

- Field Erections and Steel Structures
- For Frames, Trailer Hitches and Chassis
- Low Hydrogen Electrode For Low, Medium & High Carbon steel

Size	Catalogue # / pounds		
	1 lb	5 lbs	10 lbs
3/32"	40701	30705	-
1/8"	40801	-	30810
5/32"	40901	-	30910

- For High Strength (70,000 PSI Min. Tensile Strength) Welding Requirements

41000 MILD STEEL ROD DISPLAY RACK

Contains one package of each



# CAT.	DESCRIPTION
41101	6011 Electrode - 3/32" - 1 lb.
41201	6011 Electrode - 1/8" - 1 lb.
41301	6011 Electrode - 5/32" - 1 lb.
40301	6013 Electrode - 3/32" - 1 lb.
40401	6013 Electrode - 1/8" - 1 lb.
40501	6013 Electrode - 5/32" - 1 lb.
42001	7014 Electrode - 3/32" - 1 lb.
42101	7014 Electrode - 1/8" - 1 lb.
42201	7014 Electrode - 5/32" - 1 lb.
40684	7018 Electrode CA - 1/8" - 1 lb

SPECIALTY ELECTRODES



SPECIALTY ELECTRODES

See pages 7-9 for Boxed Specialty Rods

Attractively packaged in plastic sleeves with zip locks to prevent moisture and dirt damage to the rod. Each package has specific, pertinent information and up to date safety warnings. Display Specialty Rods with Header Cat #10573. Opening Inventory Cat# 42680 (pictured at left).

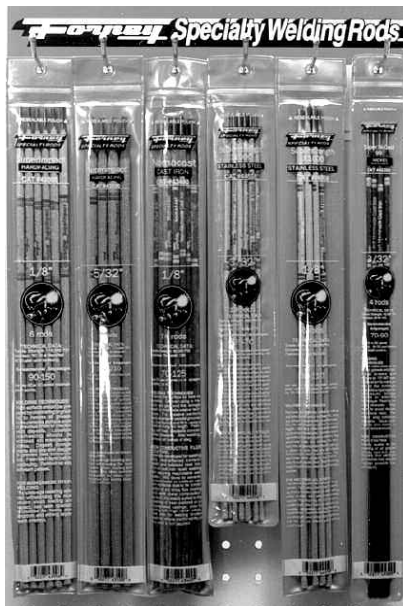

OPENING INVENTORY CAT# 42680

Cat.#	Description
42397	Supercote Hardfacing 1/8"
42801	Superwear 1/8"
43400	Nomacast 1/8"
44556	Stainless Steel 3/32"
44559	Stainless Steel 1/8"
45300	99% Nickel 3/32"
45460	55% Nickel 3/32"
45464	55% Nickel 1/8"
45889	DC Aluminum Arc 1/8"
46111	Easy Flo Aluminum 1/8"x18"
48571	Forney Super Sil-Flo 14"
45860	Super Blast Gouging 1/8"

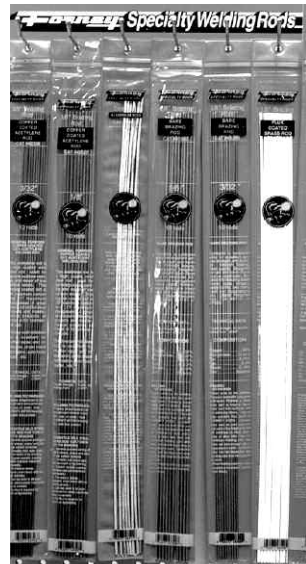
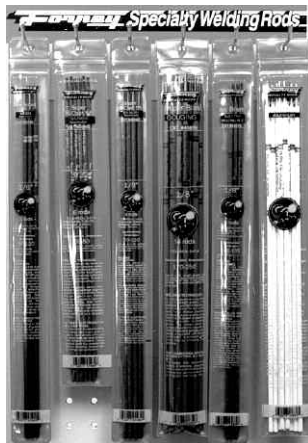

WELDING ELECTRODES AND ROD

SUPERCOTE A

Supercote is an excellent general purpose low cost hard surfacing rod for surfaces subjected to abrasive wear and impact.

Quantity	5 lbs.	5 lbs.	1 lb.
Dia.	1/8"	5/32"	1/8"
Catalogue #	42405	42415	42397
Amperage	70 - 110	70 - 110	70 - 110

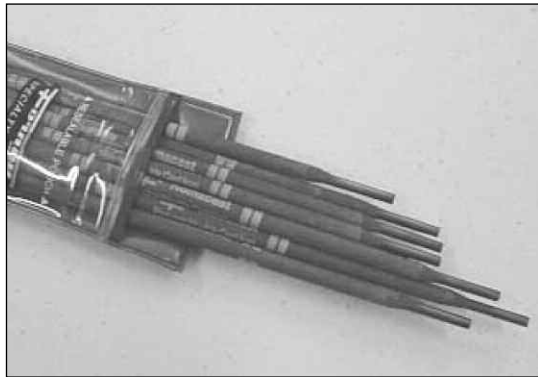

NOMACAST - A.W.S. Electrodes 1/8"

A non-machinable steel electrode designed to run at low amperage to repair cast iron. Use on cast parts that are not subjected to heating and cooling in normal use and where machining is not required. Tensile strength about twice that of a good grade of cast iron. Suitable for use on transmission housings, gear boxes and many other casting. May be used to join cast to other metals.

Dia.	Amps	1/2 lb.	1 lb.	5 lbs.
1/8"	70-125	43400	43401	43405

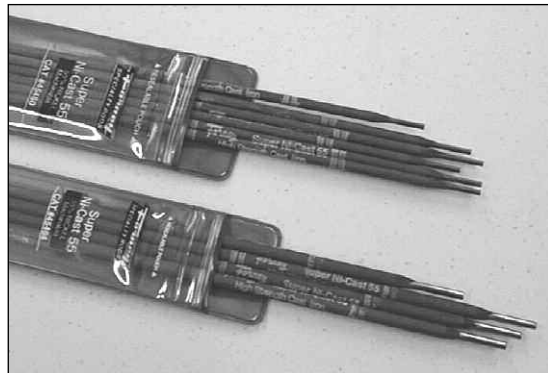

SUPER-NI-CAST-55

ULTIMATE ELECTRODE FOR ALL CAST IRONS

The state - of - the - art coated electrode for welding every known grade of cast iron, heavy sections of thin, and for joining these cast irons to steel. The Computer Controlled Coating produces welds that represent the optimum balance between tensile strength and machinability

TYPICAL APPLICATIONS

Weld all GRADE 30 - 40 - 50 gray cast iron: ductile, nodular (spheroidal graphitic iron), malleable, Meehanite Engine blocks and diesel heads. Gear boxes, transmission housings, differentials. Machine bases and presses.

Dia.	Amps	1/2 lb.	1 lb.
3/32"	50-80	45460	45461
1/8"	70-110	45464	45465

Technical Data

Tensile Strength: 70,000 PSI
Specifications: E NiFe-CI

ARC & ACETYLENE WELDING RODS



STAINLESS STEEL ELECTRODE

FOR WELDING ALL STEELS

The absolute ultimate computer-engineered, high alloy electrode for welding every known grade of steel using every known stick electrode power source! The first truly AC-DC mineral-coated high alloy that can be used by anyone, regardless of prior welding experience. Superior combination of tensile strength and elongation. Arc so ionized you cannot short it out.

Technical Data:
Tensile Strength: 128,000 PSI
Elongation: 32%

Size	Amps	1/2 lb.	1 lb.
1/8"	60-110	44559	44560
3/32"	35-70	44556	44557

ALUMINUM ARC ROD

HIGHEST STRENGTH ALLOY FOR ARC & TORCH WELDING LOW ALLOY ALUMINUM

Universal electrode for welding all cast, wrought and extruded aluminum, and all aluminum alloys in all positions.

TYPICAL APPLICATIONS:

Truck Beds, Bodies, and Frames. Loading Ramps and Docks. Pipe, Railing, Banisters, Stairs and Diamond Plate. Door & Window Frames & Supports. Irrigation Piping. Transmission Housings & Gear Boxes. Engine and Motor Blocks. Machine Bases and Supports. Bus Bars, Electrical Switch Boxes and Mounts.

Technical Data: Tensile Strength: 34,000 PSI
Can also be used as a Torch Brazing Alloy.

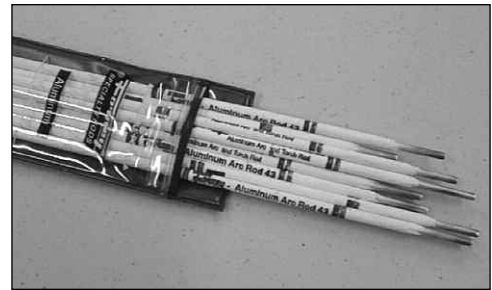

Size	Amps	1/2 lb.	1 lb.
1/8"	70-120	45889	45890

GENERAL PURPOSE OXY/ACETYLENE WELDING ROD MILD STEEL

High Quality mild steel rod for repair of low carbon steels. Copper coated rod is .06 maximum carbon and .17 maximum manganese. Great all around rod for shop projects and maintenance projects for home or commercial use. 45,000 PSI Tensile Strength. 2700°F melting point.

Description	catalogue #	
1/16" x 36"	42330	5 lbs.
3/32" x 36"	42335	5 lbs.
1/8" x 36"	42340	5 lbs.

FLUX COATED BRAZING ROD

(LOW FUMING BRONZE)

High Quality, low fuming bronze brazing rod with flux. Formulated for high tensile strength and ductility. Smooth flowing. Excellent for most brazing uses. Flux coated for best cleaning action. 65,000 PSI Tensile Strength. 1598° F melting point.

Description	catalogue #	
3/32" x 36"	48495	4 lbs.
1/8" x 36"	48504	4 lbs.
3/32" x 18"	48490	(10 Rods)
1/8" x 18"	48500	(10 Rods)



SOLDER AND FLUXES



LEAD-FREE SOLDER (Orange Labels)

Tin-Antimony "Lead-Free" solder can be used for soldering potable water pipe joints. Good for plumbing, refrigeration systems and other non-electrical applications where strength is required.

Cat. #	Grade	Tensile Strength	Melting Temp °F	Melting Temp °C	Wt.
38057	1/8" 95/5	6000	464	240	1/4 lb.
38061	1/8" 95/5	6000	464	240	1/2 lb.
38056	1/8" 95/5	6000	464	240	1 lb.



ROsin CORE SOLDER (Blue Labels)

Ideal for electric wiring connections because its residues are non-conductive. Will not cause deterioration or malfunction of electrical connections.

Cat. #	Grade	Tensile Strength	Melting Temp °F	Melting Temp °C	Wt.
38070	1/8" commercial -		575	299	1 lb.
38071	3/32" 30/70	4500	491	255	1/2 lb.
38072	3/32" 40/60	4900	460	238	1/4 lb.
38073	1/16" 60/40	4900	390	198	1/4 lb.
88107	1/16" 60/40	6900	375	190	250 gr.
88108	1/16" 60/40	6900	375	190	500 gr.



ACID CORE SOLDER (Red Labels)

General purpose solder for sweat fittings, sheet metal joints, gutter work and other big jobs. Works well on galvanized sheet, copper, steel, nickel plate, brass and tin plate. **(NON ELECTRICAL)**

Cat. #	Grade	Tensile Strength	Melting Temp °F	Melting Temp °C	Wt.
38101	1/8" commercial -		575	299	1 lb.
38102	1/8" 30/70	4500	491	255	1/4 lb.
38103	1/8" 95/5	4900	460	238	1/2 lb.



SOLID WIRE SOLDER (Green Labels)

For general use with appropriate type flux such as Forney FireEater #38127, Paste Flux #38128. 50/50 is popular for radiator repair. **(Not for Aluminum)**

Cat. #	Grade	Tensile Strength	Melting Temp °F	Melting Temp °C	Wt.
38114	1/8" commercial -		575	299	1 lb.
38111	1/8" 30/70	4500	491	255	1/2 lb.
38108	1/8" 40/60	4900	460	238	1/4 lb.
38109	3/32" 50/50	5500	421	216	1/4 lb.
38110	1/8" 50/50	5500	421	241	1/2 lb.

FLUXES, GEL AND ANTI-SPATTER SPRAYS



37028

37028 COLD GALVANIZING COMPOUND (76245)

High quality Spray Galvanizing Compound provides exceptional surface protection from rust and corrosion and is specially formulated for easy spraying. 15 oz. can



37029

37029 ANTI-SPATTER POWDER (76243)

Provides protection from weld spatter and Mig gun stick up. For users who prefer the convenience of a dry powder over liquids and gels. Often preferred because it is visible where applied. 11-1/2 oz. can



37030

37030 ANTI-SPATTER LIQUID (76249)

Eliminates welding spatter from the welding zone, mig nozzles, contact tips & surfaces where spatter is objectionable. 13 oz. can



37031

37031 FORNEY NOZZLE GEL

Gel eliminates erratic operation with a film that will not clog orifices and threads. Suitable for use on fixtures of semi and automatic welders. Odorless, non-flammable, non-toxic and silicone free. Will not cause porosity. 16 fl. oz.

MIG WELDING WIRE



MIG WIRE (E70S-6)

Ideal for auto body repair and light fabrication on most thin metals. Contains a higher level of manganese and silicone for a superior weld even on rusty, dirty steel. Produces a smoother bead which requires less grinding. Argon CO2 mix gas shielding required. Use DC reverse polarity. 70,000 PSI Tensile Strength

Diameter	2-lbs.	10-lbs.	30-lbs.	44-lbs.
.023	42290	42285	42275	
.030	42291	42286	42276	
.035	42292	42287		44281
.045				44282



SELF SHIELDING MIG WIRE (E71T-GS)

Self-Shielding all Position Flux Cored Welding Wire
Single pass applications
Excellent for use on thin gauge mild steel High travel speed
Low spatter No shielding gas required 70,000 PSI Tensile Strength
Use DC (straight polarity)

Diameter	1-lbs.	2-lbs.	10-lbs.
.030		42300	42301
.035	42304	42302	42303



42298 (308ER) STAINLESS STEEL MIG WIRE

Welds type 301 302 304 308 321 & 347 stainless steels.
Applications: Food & Beverage Industry, Maintenance and Repair.
Contains 20% Chromium,10% Nickel.
Argon or Argon/CO2 gas shielding required.
85,000 PSI Tensile Strength.

5356 ALUMINUM ALLOY MIG WIRE

5% Magnesium
Bright Finish...Flows freely at 1180°F
Can be used for Mig & Tig welding
Argon gas shielding required.
Applications: Diesel Engine Bases, Truck Frames, Cargo Tanks, Gun Mount Bases 40,000 PSI Tensile Strength.

42293	.030 (5356)	1 lb.
42294	.035 (5356)	1 lb.
42295	.030 (4043)	1 lb.
42296	.035 (4043)	1 lb.



WELDING ACCESSORIES

93097 14-3/8" DELUXE STORAGE CAN

Made of high impact polypropylene plastic. Tight Sealing Screw type cap and rubber O-ring- provide clean, dry, air-tight storage for electrodes. Store up to 10 lbs. of Forney 3/32", 1/8", 5/32" electrodes in 12" & 14" lengths in four convenient compartments.



59021

SOLDERING IRON

59021 30 WATT/110V SOLDERING IRON*

For Fine Wiring, Hobbies: Models, Making Jewelry
Electronics: TV's, Radios, Stereos, Games and Toys

* Comes in Clamshell Packaging



38115 SILVER SOLDER KIT

One length of 12' x 1/16" and one ounce of flux.
Can be used on stainless steel, copper, brass,
nickel alloys, nickel, chrome plated metal and iron.
Stays bright and hard. Nontoxic can be used in
contact with food. 96.5% tin, 3.5% silver.

18000 lb. Tensile Strength.

38059 Liquid flux available separately from 38115.

SOLDER & SOLDERING PASTE

38116 SOFT SILVER SOLDER KIT

Five percent silver content. Self fluxing. Comes in plastic dispenser tube to protect from dirt, & moisture. Can be used on stainless steel, copper, brass, nickel alloys, nickel and chrome plated metal and iron. Stays bright & hard. Harmless in contact with food. Nontoxic. Joint strength up to 20,000 PSI Tensile Strength. (Working temperature up to 1,100° F). Application Temperature 400° F to 700° F

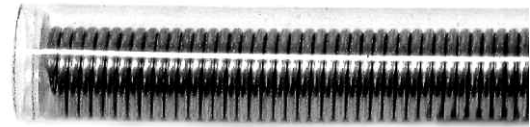

38116

SOLDERING FLUX

For soldering and tinning.

Plumbers, workers in brass, copper, tin, steel & stained glass will achieve superior results with these easy to use products. Produce strong, neat, durable joints. Rubyfluid allows solder to flow in a thin film. Adheres quickly and stays where its applied. Available in paste or liquid.

60301.....	3.5 fl. oz.
38125.....	PASTE 2 oz.
60303.....	PASTE 2 oz.



60301



38125

SOLDERING FLUX BRUSH

Tinning brush for liquid or paste flux.

38141.....	Brush (1GROSS)
60300.....	Brush (3/skin-packed)



60300

42260 SPEEDYBOND for Steel Opening Inventory

42262 SPEEDYBOND for Plastic Opening Inventory

Similar texture as clay. Ideal to repair metal and plastic articles, split or broken. Quickly dries; industrial force. Contains no solvent. When dry, can be bored easily or painted. Proper for interior or exterior work. Resistant to water, chemical product and extreme temperatures.

42267 Steel tube by unit **42269** Plastic tube by unit
Display tray # **10399** - free if you order the opening inventories 42260 and 42262.

38064 J-B QUICKWELD • Two tubes of 1 oz. skin pack
J.B KWIK is great for hobby or craft projects house -hold and auto repair. Cures in 4 minutes. Withstands temperatures to 300° F.

38065 J-B WELD • Two tubes of 1 oz. skin pack

38066 J-B INDUSTROWELD • Two tubes of 5 oz.

38067 J-B WATERWELD • Two tubes of 1 oz. skin pack
For repairs to water lines & containers etc..

38069 J-B MARINEWELD • Two tubes of 1 oz. skin pack
Waterproof, weatherproof, non-corrosive, withstands grease, petro-chemicals and high temperatures to 600° F. Many marine uses fixing deck gear, gally equipment, engines, masts and hulls. So tough you can drill, grind or machine it.



42667

42269



38065



38066

MIXES LIKE PUTTY, BONDS LIKE EPOXY, HARDENS LIKE STEEL

ELECTRODE HOLDERS

ELECTRODE HOLDERS

Brass Bodies, Fiberglass Covers and Triggers Provide Excellent Conductivity and User Protection. Holders Insulated for Safety and Maximum Operator Protection. Grooved Jaws allow Electrodes to be used at Different Angles for Greater Operator Comfort & Efficiency.



56000

56000 TYPE F-2 200 AMP HOLDER

Designed for up to 5/32" rods. Widely used in steel fabrication. Will accept up to #2 welding cable. 8-1/2" length.

56200 TYPE F-3 ELECTRODE HOLDER 300 AMPS 10-1/2" LONG

Heavy-Duty Electrode Holder. Suitable for most arc welding jobs. Accommodates rods 3/32" through 3/16" diameter. Will accept up to #2 welding cable.



56200

56205 SCREW TYPE ELECTRODE HOLDER 400 AMP HOLDER

A quarter turn of its handle locks the jaws tight on the rod. No slip easy grip handle. Brass body with oval point screw for positive contact of cable and handle. Vulcanized fiber insulators designed for longer wear. Holds rod from 3/32" to 3/16" diameter. Will accept up to #2 welding cable. 8-1/2" length.



56205

WELDING EQUIPMENT AND ACCESSORIES

STEEL AND BRASS GROUND CLAMPS

STEEL GROUND CLAMPS

Rugged, Economical Ground Clamps for Shop, Maintenance and Fieldwork.

54410 STEEL GROUND CLAMP 300 AMP

Good positive connection. 1-3/4" wide jaw openings. 8" long. Suitable for all farm and shop welders. #2 cable capacity.



54510 STEEL GROUND CLAMP 500 AMP

For extra heavy jobs. Capacity to 500 Amps. Fine for good grounds on steel plate, angle iron, pipe, etc. 2-1/4" jaw opening. 9-1/2" long. #1/0 cable capacity.

BRASS GROUND CLAMPS

Large Contact Area of These Clamps Assures Positive Grounding. Oval-point Screw Cable Connections make Installation Easy, Assuring Good, Safe Cable Connections. Shim Stock Provided.

54300 BRASS GROUND CLAMP 200 AMP

Wide grooved jaws for positive ground. For medium-duty use. 3/4" jaw opening. 5" long. #2 cable capacity.



54400 BRASS GROUND CLAMP 300 AMP

Wide grooved jaws for positive ground. For medium-duty use. 3/4" jaw opening. 5" long. #2 cable capacity.



54405 BRASS GROUND CLAMP TWECO STYLE 500 AMP

Rugged, versatile, wide jaw ground clamp. Good for most grounding situations. Large contact surface area provides good cable connections and positive grounding. 2" jaw opening. 8" long. #1/0 cable capacity.



WELDING CABLE & ACCESSORIES



FORNEY WELDING CABLE

Highly flexible welding cable manufactured with 30 gauge fine stranded, soft drawn electrolytic copper for maximum conductivity. Vinyl (not paper) sheath separates copper from outer nitrile rubber sheath for super flexibility. Will not kink—even in cold weather. Outer sheath has excellent oil, water and abrasion resistance. Rated at 600 volts. Operating range of -30°F to 150°F. Sequentially marked by the foot, eliminating the need to “floor” measure the cable in the store.

52010	Welding Cable #1/0	By the foot
52016	Welding Cable #1	50'
52017	Welding Cable #1	100'
52018	Welding Cable #1	150'
52019	Welding Cable #4	50'
52020	Welding Cable #4	125'
52021	Welding Cable #4	250'
52023	Welding Cable #2	50'
52024	Welding Cable #2	125'
52025	Welding Cable #2	250'

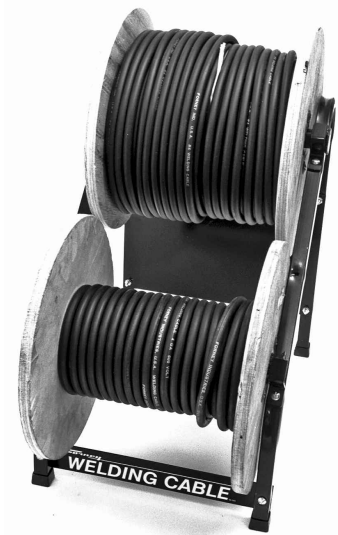

CABLE SELECTION GUIDE

AMPS	0 - 50'	50 - 100'	100 - 150'	150 - 200'	200 - 250'
100	6 Awg	4 Awg	2 Awg	2 Awg	1 Awg
150	4 Awg	4 Awg	2 Awg	2 Awg	1 Awg
180	4 Awg	4 Awg	2 Awg	2 Awg	1 Awg
200	4 Awg	2 Awg	2 Awg	1 Awg	1-0Awg
225	4 Awg	2 Awg	1 Awg	1 Awg	1-0Awg
250	2 Awg	2 Awg	1 Awg	1 Awg	1-0Awg
300	1-0Awg	-	1-0Awg	-	1-0Awg

CABLE CONNECTOR (PAIR)

Camlock quick connectors for welding cable extensions.

57710 - Heavy Duty.....#1 - #4 Welding Cable

57715 - Heavy Duty.....#1/0 - #2/0 Welding Cable



ARC AND MIG WELDER ACCESSORIES

CABLE ENDS SPLICERS & BUMPER JUMPER

FEMALE REPAIR JACKS FOR FORNEY WELDERS

Includes fiber washers & retainer knobs. Fit Models C, CB, FS & F Series Forney Welders .

- 57510.....with black retainer knob
- 57511.....with red retainer knob
- 57512.....for Miller Welders

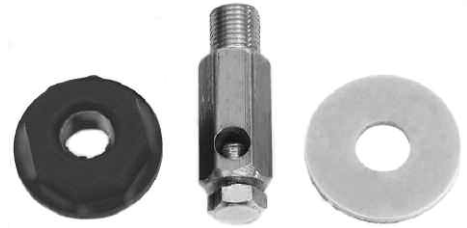

57512 FITS MILLER
57510 black Forney 57511 red Forney

MALE SURE GRIP PLUGS FOR CABLE EXTENSIONS AND BUMPER JUMPER BOOSTER (SEE BELOW)

For assembly or replacement of welding cables #6 to #2. Makes mechanical connection with no soldering. Good for special connecting applications, light to heavy duty. Use on C, CB, FS & F series Forney & Miller welders. Complete with machined solid brass bar stock male plug, insulator sleeve, shim & set screw.

- 57901With black Insulator Forney 3/8"
- 57902With red Insulator Forney 3/8"
- 57903With black Insulator (Miller/Spitfire 5/16"
- 57904With Red Insulator (Miller/Spitfire 5/16"
- 57912Male Plug Fits Comet Welder
- 57915Male Plug W / Insulator for LKS Welders

57901 black
57902 red



FEMALE SURE GRIP PLUG

For assembly or replacement of welding cables and extension cables #6 to #2. Makes mechanical connection with Male Sure-Grip Plugs. Black insulators only.

- 57701Accepts 57901 & 57902 (Forney)
- 57702Accepts 57903 & 57904 (Forney & Spitfire)
- 57913Female Plug W / Insulator Fits Comet Welder
- 57920Female Plug W / Insulator for LKS Welders fits 57915

57701
57702



57705 SPLICER FOR #2 - #6 CABLE

For permanently splicing damaged or broken cables & adding additional cable length to existing welding cable leads.

57705



52841 BUMPER JUMPER

Mount between bumper & service unit battery. Use with male Sure-Grip Plugs (57901 & 57902) on bumper plate end of jumper cables. Starts cars, tractors, trucks with dead batteries in a breeze. Excellent for service stations, auto dealers, garages, trucking firms, contractors, farmers, ranchers. Kit includes output jacks, retaining knobs, insulating washers & bumper plate.

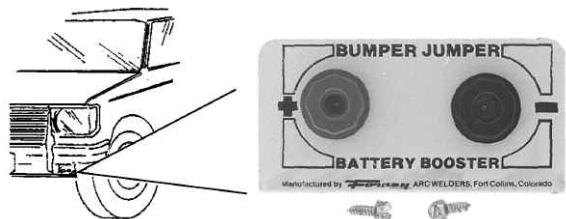

CABLE LUGS & BUTT CONNECTORS

CABLE TERMINAL LUGS AND BUTT CONNECTORS

Premium all-copper cable lugs, carefully engineered and manufactured for sound, solid connections and trouble free service. Easily crimped and/or swaged. Made from electrolytic copper rated for 100% conductivity.

CABLE LUG KITS

- 57639.....Display Tray Only for 57640 / 57641
 - 57640*.....(57645 to 57656) Total of 104 Lugs
 - 57641.....(57645 to 57656) 1 ea. of 12 Lugs
 - 57642.....Display Tray Only for 57643
 - 57643.....New Lug/Butt Connector Assortment
with Tray 57657 to 57668 (5 ea. = 60 Total)
- *Kit includes a display tray with an assortment of 4 to 16 #57645 to 57656. See below.

- 60088.....Cable Lugs & Connectors Inventory
- 60089.....Cable Lugs Opening Inventory

INDIVIDUAL CABLE LUGS

Individual Cat#	Skin Pack Cat # (Packed in prs.)	No. Incl. in kit #57640	Cable Size	Stud Size
57645	60090	12	8	#10
57646	60091	12	6	1/4"
57647	60092	16	4	5/16"
57648	60093	16	4	3/8"
57649	60094	12	2	5/16"
57650	60095	6	1	3/8"
57651	60096	6	1/0	3/8"
57652	60097	6	1/0	1/2"
57653	60098	6	2/0	3/8"
57654	60099	4	2/0	1/2"
57655	60100	4	3/0	1/2"
57656	60101	4	4/0	1/2"

NEW CABLE LUGS

57657	60102	5	8	3/8"
57658	60103	5	6	3/8"
57659	60104	5	4	1/2"
57660	60105	5	2	3/8"
57661	60106	5	2	1/2"
57662	60107	5	1	1/2"

NEW BUTT CONNECTORS

57663	60108	5	8	
57664	60109	5	6	
57665	60110	5	4	
57666	60111	5	2	
57667	60112	5	1/0	
57668	60113	5	2/0	

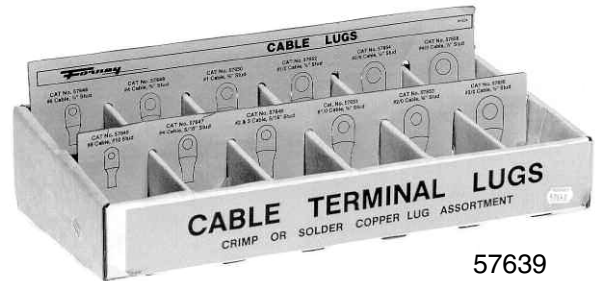

57639



Cable Lugs



Cable Lugs



Butt Connectors

CABLE LUGS

MIG WELDER EQUIPMENT & ACCESSORIES

MULTIMETERS AND WELDING ACCESSORIES



57300 Pocket Size Digital Multimeter

- 7 functions...16 measuring ranges
- Test: DC Voltage, DC current, Resistance, Batteries, Diodes, Tests Audible Continuity and Transistors
- Single knob function switch
- Test Leads
- Nine volt battery included
- Complete instructions inc

57301 Pocket Size Multimeter

- 5 functions, 14 measuring ranges, test leads
- Compact, replaces cumbersome meters
- Wide open dial, clear markings
- Measures AC, DC and resistance
- Self contained resistance battery inside back cover
- Complete instructions included



50 AMP 230 VOLT MALE PLUGS & FEMALE RECEPTACLES

For Welders, Electric Stoves, Dryers, Table Saws and 220 V Power Equipment

Opening Inventory 57598

(1 Ea. 57601, 57602, 58400, 58401, 58402, 58499)

10501 P - O - G (Free) 6 ea. 10232 (free)



57601

57602

58499

58402

58400

58401



REPLACEMENT CARBON

Made with a central core of specially selected materials to give a steadier, quieter arc on alternating current than solid carbon electrodes. Ideally suited for welding and brazing.

CATALOGUE #	SIZE	Carbons PER CARD
60313	5/16" diameter x 6" long	2
60314	3/8" diameter x 6" long	2
60315	1/2" diameter x 6" long	2

INDUSTRIAL QUALITY CUTTING TOOLS

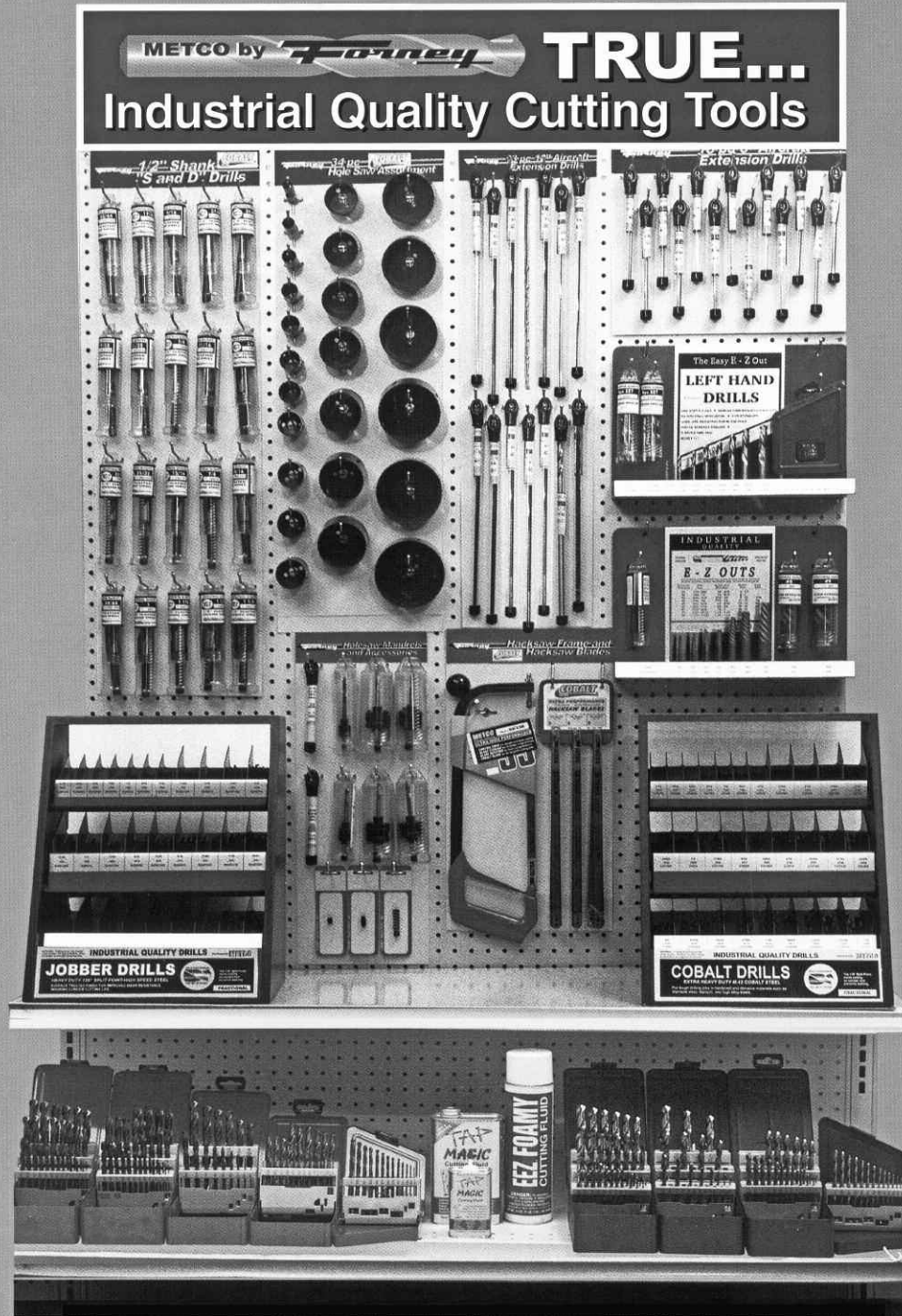

Forney Proudly announces a NEW product line to our successful Family of Metal-Working™ Products... METCO BY FORNEY™. A TRUE Line of Industrial Quality Cutting Tools made with the Best, most durable and consistent QUALITY Steel on the Market Today:

- Aircraft Drills
- Shank Drills
- Left Hand/E-Z Outs
- Masonry Bits
- Taps & Dies
- Extension Drills
- Cobalt Hole saws
- Hacksaws/Cobalt Blades

The opening inventories above feature colorful Plan-O-Grams & user friendly displays. Products on Plan-O-Grams are packaged and labeled in the tried and proven Forney system.

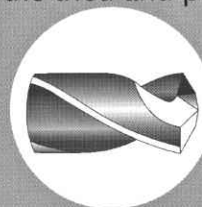

Many of our drill bits feature the 135° split point allowing the user to drill on contact (no punching necessary even on pipe).

OXY-ACETYLENE ACCESSORIES



86102 SINGLE FLINT STRIKER

Our most popular model. Features a square hood and round file with a patented assembly. Dependable. Light weight. Low cost



86103 THREE FLINT STRIKER

Quality tool. Rugged frame. Three large flints. Long lasting round file and brite plated finish. Dependable ignition under all working conditions. Release slotted screws to rotate new flint into position.



86104 THREE-FLINT REPLACEMENT STRIKER FLINTS

Three way rotating flints. Package of Four. Total of twelve flints skin packed on card. Fit most three flint lighters and Forney 86103 Three Flint Lighter.

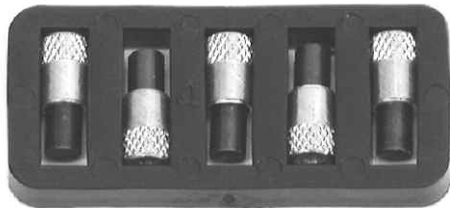

86122 SINGLE REPLACEMENT STRIKER FLINTS

Fit all standard screw-on type lighters and Forney 86102 Single Flint Lighter. Renewal flints easily installed.



86119 LONG TIP CLEANER KIT

Similar to Forney 86120. Extra long cleaners. Tip Cleaner Kit provides as many as 60 or more cleaning edges per inch of cleaner. Fits all tip sizes. Light and easy to use. Contains 13 sizes-6 through 26. Aluminum case includes dressing tool.



86120 STANDARD TIP CLEANER KIT

Tip Cleaner Kit provides as many as 60 or more cleaning edges per inch of cleaner. Fits all tip sizes. Light and easy to use. Contains 13 sizes-6 through 26. Aluminum case includes dressing tool.



86140 TIP DRILL SET (EXTRA BITS STORED IN BARREL)

12 tip drills within a pencil style design, with pocket clip. Used to clean and true most standard orifices of acetylene welding and cutting tips.

OXY-ACETYLENE ACCESSORIES



86101



88066

OXY-ACETYLENE HOSE ASSEMBLIES (GRADE R)

Forney quality Acetylene twin welding hoses complete with fittings. Kink proof for safety & service. Flexible yet strong enough to supply a 4:1 safety factor for welding applications. Neoprene covers. Rated at 100 PSI.

Cat #	Hose Type	Length
86101	3/16" Hose Set	20'
86113	3/16" Hose Set	25'
86109	3/16" Hose Set	50'
86145	1/4" Hose Set	25'
86146	1/4" Hose Set	50'

88066 PLUMBERS TORCH HOSES

A-fittings for Forney and similar kits. 12-1/2'

HOSE NUTS* "B" FITTING, 9/16"

86124.....	Acetylene
86125.....	Oxygen



HOSE FERRULES* OXY-ACETYLENE

86126.....	3/16"
86135.....	1/4"



HOSE BRACE* OXY-ACETYLENE

86127.....	3/16"
86136.....	1/4"



BARBED HOSE NIPPLES* OXY-ACETYLENE

86128.....	3/16"
86137.....	1/4"



HOSE COUPLERS*

"B" FITTING, 9/16-18THD FOR 3/16" & 1/4" HOSE. Allows user to increase the length of their hose for hard-to-reach places.

86129.....	Oxygen
86130.....	Acetylene



OXY-ACETYLENE ACCESSORIES

86131	3/16 "	Hose Connector
86138	1/4"	Hose Connector

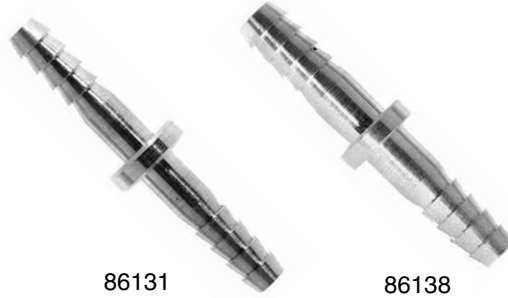

OXY-ACETYLENE QUICK-CLIC CONNECTORS

Quick couplers for instant removal and storage of valuable cutting heads and torch attachments.

87155 - Torch To Hose

87156 - Hose To Hose

87157 - Regulator To Hose

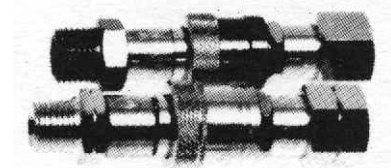

87155 87156 87157

CHECK VALVES (Sold as pairs only)

87147 • REVERSE FLOW HOSE TO TORCH

Prevents gases from mixing in hoses; a common cause of explosions, fires & lost time injuries. Can be used in all Class B connections (9/16-18) even if fuel gas pressure is only 4 ounces. Fit between hose & torch.

87147



87151 • REVERSE FLOW REGULATOR TO HOSE

Prevents gases from burning through regulators to tanks leading to extreme damage, explosions, fires, personal injury & property damage. Fit between regulator outlet and Hose.

87151



REGULATOR FITTINGS

87731 OUTLET CONNECTION (OXYGEN)

87732 OUTLET CONNECTION (ACETYLENE)



87731

87732

87733 INLET NUT (OXYGEN) CGA 540

87734 INLET NUT (ACETYLENE) CGA 510



87733

87734

87735 - INLET SWIVEL, OXYGEN CGA 540

1/4" NPT

87736 - INLET SWIVEL, ACETYLENE CGA 510

1/4" NPT



87735

87736

OXY-ACETYLENE HOSE REPAIR KITS

86139 OXY-ACETYLENE HOSE REPAIR KITS

Each Hose Repair Kit Contains 12 Parts to Repair Any Damaged or Cut Twin Hose. Locking Crimping Tool Included with Kit 86139. Each Compartment Clearly Marked for Easy Identification.

Make hose repairs fast and simple.

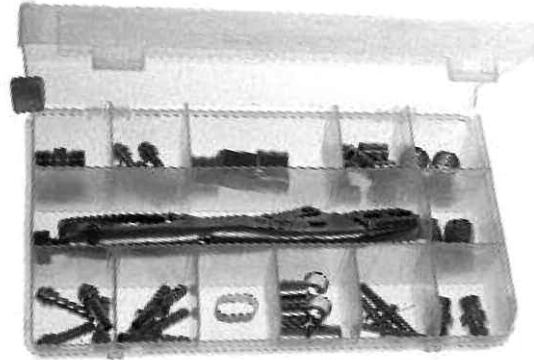

86139

Included With Kit

(1) 10-1/2" x 6-1/2" Plastic Box with 13 Compartments

- 86124 (4) Acetylene Hose Nuts
- 86125 (4) Oxygen Hose Nuts
- 86126 (8) 3/16" Hose Ferrules
- 86127 (1) 3/16" Hose Brace
- 86128 (4) 3/16" Oxy-Acetylene Hose Nipples
- 86129 (2) Oxygen Hose Couplers
- 86130 (2) Acetylene Hose Couplers
- 86131 (4) 3/16" Oxy-Acetylene Hose Splicers
- 86135 (8) 1/4" Oxy-Acetylene Hose Ferrules
- 86136 (3) 1/4" Oxy-Acetylene Hose Braces
- 86137 (3) 1/4" Oxy-Acetylene Hose Nipples
- 86138 (3) 1/4" Oxy-Acetylene Hose Splicers
- 86116 (1) Locking Grip Crimping Tool



86112



86116

ADAPTERS (OXYGEN AND ACETYLENE CYLINDERS)

For connecting oxygen, acetylene, argon etc. regulators to their respective tanks. When the connections between the regulator and tank do not match, one of these adapters may complete the connection.

87805 CGA 520 TO CGA 510

For all B Tanks (SSA-74B).
"B" Tank Cylinder to POL
Acetylene Regulator

87805



86189 Regulator To Tank Adapter

CGA 510 to CGA 410

86189

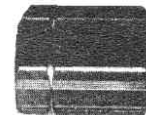

86190 Propane Cylinder To Hose Adapter

CGA 510 by 9/16 - 18LH

86190



OXY-ACETYLENE TORCH KITS & ACCESSORIES

PRESSURE GAUGES AND GAS CYLINDERS



87494



87495



87496



87497



87727



87728



87729



87730

PRESSURE GAUGES

All pressure gauge threads are common to Forney, Victor, Harris, Smith & Marquette regulators. Brass case gauges for long life.

87494 LOW PRESSURE GAUGE ACETYLENE

0-30 PSI. 2-1/2" 1/4" NPT

87495 HIGH PRESSURE GAUGE ACETYLENE

0-400 PSI. 2-1/2" 1/4" NPT

87496 LOW PRESSURE GAUGE OXYGEN

0-200 PSI. 2-1/2" 1/4" NPT

87497 HIGH PRESSURE GAUGE OXYGEN

0-4000 PSI. 2-1/2" 1/4" NPT

87727 HIGH PRESSURE GAUGE OXYGEN

0-4000 PSI. 2" 1/4" NPT

87728 HIGH PRESSURE GAUGE ACETYLENE

0-400 PSI. 2" 1/4" NPT

87729 LOW PRESSURE GAUGE OXYGEN

0-200 PSI. 2" 1/4" NPT

87730 LOW PRESSURE GAUGE ACETYLENE

0-30 PSI. 2" 1/4" NPT

86224 OXYGEN TANK

20 cu. ft. cylinder. "R" size. Recommended for portable or light demand. For use with Forney 1753 Tote-A-Torch. (Or similar Torch Kits)

86228 ACETYLENE TANK

10 cu. ft. cylinder. "MC" size. Recommended for portable or light demand. For use with Forney 1753 Tote-A-Torch. (Or similar Torch Kits)

85362 ARGON-CO₂ TANK

20 cu. ft. cylinder. For use with most Mig Welders. Can be used with #85363 regulator.

86210 VALVE WRENCH

For small "B" and "MC" cylinders (No Picture)



85362



86224



86228

OXY-ACETYLENE TORCH KITS & ACCESSORIES

WELDING NOZZLES & CUTTING TIPS FOR FORNEY & VICTOR MEDIUM DUTY 1680,1702,1705,1753 TORCH KITS

VICTOR STYLE OXY-ACETYLENE WELDING NOZZLES

Use with 87795 Mixer Assembly. See below

87822.....#0	87824.....#2
87823.....#1	87825.....#3
	87826.....#4



87822

VICTOR STYLE OXY-ACETYLENE CUTTING TIPS

Style 3-101

60445.....#000	60448.....#1
60446.....#00	60449.....#2
60447.....#0	60450.....#3
	60451.....#4



60447

VICTOR STYLE PROPANE CUTTING TIPS (2-PIECE)

Style 3-GPN

60482.....#00	60485.....#3
60483.....#0	87936.....#4
60484.....#2	

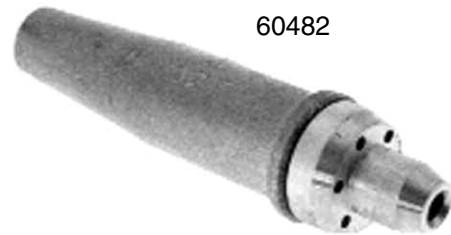

60482

MEDIUM DUTY VICTOR STYLE ROSEBUD HEATING NOZZLE

For 1702 & 1705 & 1753



87790

M.D. VICTOR STYLE WELDING NOZZLES & CUTTING TIPS

OXY-ACETYLENE TORCH KITS & ACCESSORIES

VICTOR STYLE WELDING NOZZLES & CUTTING TIPS

CUTTING AND HEATING TIPS FOR FORNEY SERIES 01711& 01757 TORCHES

OXY-ACETYLENE CUTTING TIPS FOR Victor Style Journeyman

Style 1-101 for 1757 & 01711

60462*#0	60465*#3
60463*#1	87864*#4
60464*#2	



OXY-ACETYLENE CUTTING TIPS FOR Victor Style Journeyman

Style 1-GPN for journeyman & 1757 & 01711

60471*#1	60473*#3
60472*#2	87868*#4



HEAVY DUTY VICTOR STYLE ROSEBUD HEATING NOZZLE Style Victor for 1757 & 01711

87791.....Type 11 (8-MFA)



87796 - MIXER ASSEMBLY FOR VICTOR STYLE TORCH HANDLES

FOR #87822 - 87626



* Indicates a skin-packed display item

OXY-ACETYLENE TORCH KITS & ACCESSORIES

1753 TOTE-A-TORCH PORTABLE VICTOR TYPE OXY-ACETYLENE OUTFIT

COMPLETE W / CYLINDERS

Lightweight Torch Kit is easy to store and can be carried from job-to-job. Ideal for auto repair, plumbing, refrigeration, metal art, general & industrial maintenance. It welds up to 1/2" & cuts up to 4". All accessories fit comfortably in a light, sturdy plastic tote.

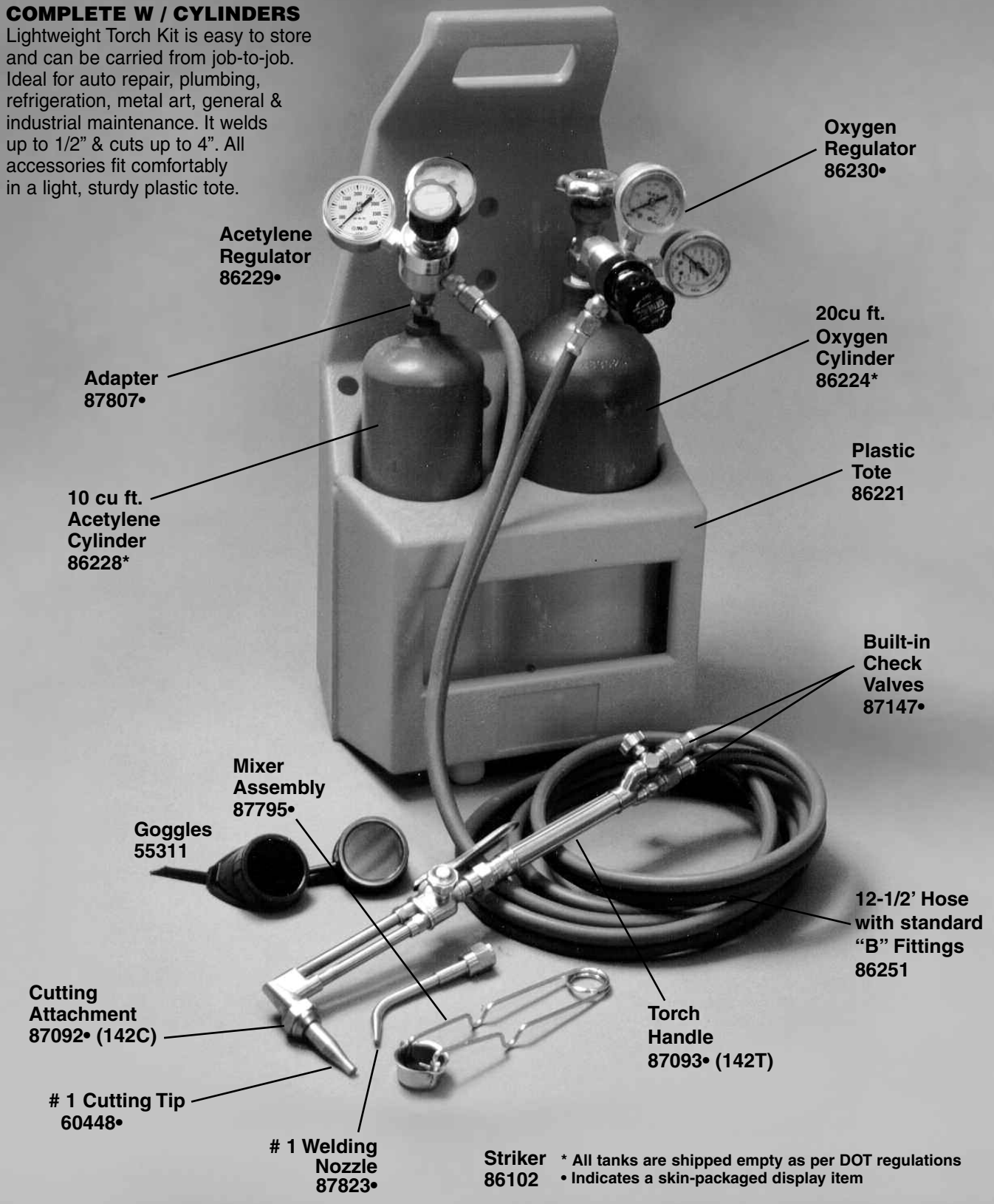

Acetylene Regulator 86229•

Oxygen Regulator 86230•

Adapter 87807•

20cu ft. Oxygen Cylinder 86224*

10 cu ft. Acetylene Cylinder 86228*

Plastic Tote 86221

Built-in Check Valves 87147•

Mixer Assembly 87795•

Goggles 55311

12-1/2' Hose with standard "B" Fittings 86251

Cutting Attachment 87092• (142C)

Torch Handle 87093• (142T)

1 Cutting Tip 60448•

1 Welding Nozzle 87823•

Striker 86102 * All tanks are shipped empty as per DOT regulations
• Indicates a skin-packaged display item

1753 TOTE-A-TORCH PORTABLE OXY-ACETYLENE TORCH KIT

OXY-ACETYLENE TORCH KITS & ACCESSORIES

1705 SHOP FLAME II TORCH KIT & REGULATORS



1705

1705 SHOP FLAME II TORCH KIT

Medium-Duty Oxy-Acetylene Unit. Precision engineered and Designed for Trouble-Free Performance. Welds up to 1/2" and Cuts up to 6". Features Built In Check Valves. Comes Complete with 20' Hose.



87090



87091

Cat #	Description
87090*	OXYGEN REGULATOR
87091*	ACETYLENE REGULATOR
87092*	CUTTING ATTACHMENT
87093*	WELDING TORCH HANDLE
87795*	MIXER ASSEMBLY
87822*	WELDING TIP
60448*	CUTTING TIP
55311	GOGGLES
86101	HOSE (3/16" x 20' not shown)
86102	STRIKER
87147	CHECK VALVES



87092



87093

OXY-ACETYLENE TORCH KITS & ACCESSORIES

1711 FORNEY HEAVY-DUTY TORCH KIT



1711• FOR THE “BIG JOBS” FORNEY SHOP FLAME HEAVY-DUTY TORCH KIT

All Components Feature Quality, Sturdy Construction for the Most Demanding Heavy-Duty Welding. Welds up to 1/2”, Cuts up to 8”. Comes Complete with Hose.

Cat #	Description
87102•	WELDING TORCH HANDLE
87104•	CUTTING ATTACHMENT
87100•	OXYGEN REGULATOR
87101•	ACETYLENE REGULATOR
87796•	MIXER ASSEMBLY
87832•	#0 WELDING TIP
60463•	#1 CUTTING TIP
86102	STRIKER 55311 GOGGLES
86101	HOSE 3/16”X20’ (not shown)



87102

87102• VICTOR WELDING TORCH HANDLE REPLACEMENT FOR 1711



87104

87104• VICTOR CUTTING ATTACHMENT REPLACEMENT FOR 1711



87100

87100• VICTOR OXYGEN REGULATOR

For Victor 1711 and other professional heavy duty applications. 2-1/2” dial faces.



87101

87101• VICTOR ACETYLENE REGULATOR

For Victor 1711 and other professional heavy duty applications. 2-1/2” dial faces.

• Indicates a skin-packed display item



OXY-ACETYLENE TORCH KITS & ACCESSORIES

1680 VICTOR COMPATIBLE LIGHT-MEDIUM DUTY TORCH KIT

Light to Medium Duty Oxy-Acetylene Unit Welds up to 3/16" and Cuts up to 4". Features Built In Check Valves for Safety. Ideal for Maintenance, Automotive, Fabrication, Plumbing and Do-It-Yourselfers. Provides High Performance at a Very Economical Price. Comes Complete with Hose.

Cat.#	Description
87070•	OXYGEN REGULATOR
87071•	ACETYLENE REGULATOR
87092•	CUTTING ATTACHMENT
87093•	WELDING HANDLE
87795•	MIXER ASSEMBLY
87822•	#0 WELDING NOZZLE
60448•	#1 CUTTING TIP
86100	3/16" x 12.5' HOSE (not shown)
86102	STRIKER
55311	GOGGLES



1680 TORCH KIT & ACCESSORIES

87070• OXYGEN REGULATOR (190X)

for 1680 & other light-medium duty applications on most oxygen cylinders



87070

87071• ACETYLENE REGULATOR (190Y)

for 1680 & other light-medium duty applications on most acetylene cylinders.



87071

87092• CUTTING ATTACHMENT (142T)

for 1680



87092

87093• WELDING HANDLE (140C) for 1680



87093

87795 MIXER



87795

OXY-ACETYLENE TORCH KITS & ACCESSORIES



**1687 PRO FLAME
HARRIS STYLE TORCH KIT**
Medium Duty Oxy-Acetylene Unit Features Built-In Check Valves for Safety & Three Tube Cutting Attachment Design. Welds up to 1/2" and Cuts up to 5". Comes with 20' Hose.

Cat #	Description
87080•	OXYGEN REGULATOR
87081•	ACETYLENE REGULATOR
87086•*	CUTTING ATTACHMENT
87087•*	WELDING TORCH HANDLE
87084•*	MIXER ASSEMBLY
60428•	#1 CUTTING TIP
87203•	#3 WELDING TIP
86102•	STRIKER
55311•	GOGGLES
86101•	HOSE 3/16" x 20' (not shown)



87086

***87086• CUTTING ATTACHMENT**
for 1687 harris style (442c)



87087

***87087• WELDING TORCH HANDLE**
for 1687 harris style(442t)



87080

87080• OXYGEN REGULATOR
for 1687 harris style (452x)
And other medium duty applications

Regulators can be used on all Oxygen & Acetylene cylinders



87081

87081• ACETYLENE REGULATOR
for 1687 harris style (452y)
And other medium duty applications



87084

87084• MIXER
For HARRIS STYLE TORCH

** Will not interchange with Harris Equipment*

1687 PRO FLAME MEDIUM DUTY TORCH KIT

OXY-ACETYLENE TORCH KITS & ACCESSORIES

INTRODUCING... THE NEW DP4 FACE SHIELD

Unique design features a clear window for grinding and
a #5 shaded flip down window for cutting and brazing or
a #8 shaded flip down window for Gas Tungsten Arc Welding
(GTAW) or low-amperage Plasma Arc Cutting and Welding

Clear window DP4 with #5 flip-down window - Cat #58615
Clear window DP4 with #8 flip-down window - Cat #58616
Replaceable light-weight ratchet headgear - Cat #58624
Replacement clear window (Cat #58620), #5 flip-down (Cat #58621)
and #8 flip-down (Cat #58622) windows are readily available

Meets ANSI Z87.1 standards

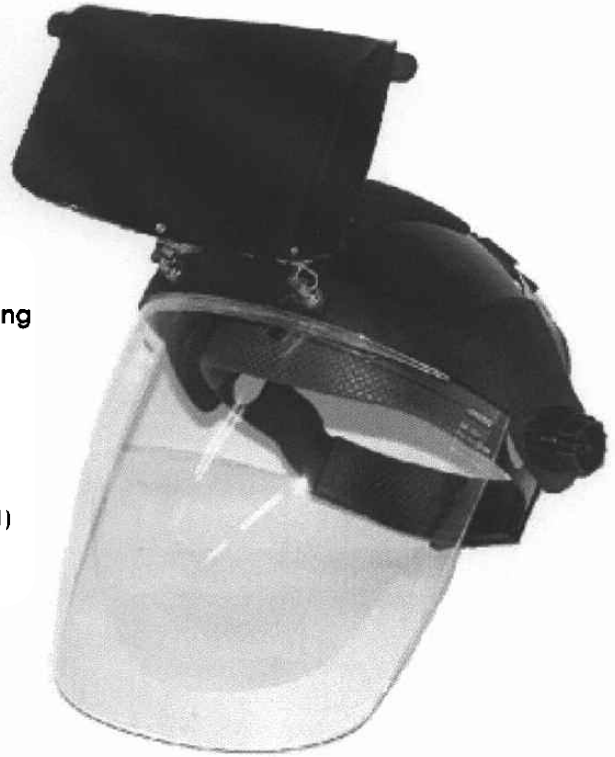

1720 & 1723 TORCH KIT



1720• COMPACT, LIGHT-DUTY AIR ACETYLENE PLUMBER'S TORCH KIT

For Plumbing, Heating and Refrigeration Use

- Heat, Solder & Braze Pipe, Tubing & Thin Gauge Metals
- Easy to Operate
- Adjusts Fuel-Air Mixture Accurately

Cat.#	Description
88061•	#1 Brazing Heating Tip
88062•	#3 Brazing Heating Tip
88063•	#5 Brazing Heating Tip
88064•	Regulator/400 PSI
88065•	Gauge for Regulator (88064)
88066•	Air/Acetylene Hose (12-1/2"X3/16" A Fittings)
88067•	Torch Handle

*Included in Kit. Made in AMERICA

1723• ALL PURPOSE UNI-FLAME BURNER/500,000 BTU'S

- Burn Weeds, Melt Ice and Repair Asphalt and Tar on Roads
- Complete with Striker and 10' Hose
- Attaches Directly to Small 20# Propane Cylinder with POL Fitting
- Attractively Skin-Wrapped*



OXY-ACETYLENE TORCH KITS & ACCESSORIES

WELDING NOZZLES AND CUTTING TIPS FOR FORNEY 1687 TORCH KIT & HARRIS MEDIUM DUTY EQUIPMENT

HARRIS STYLE WELDING NOZZLES-THREADED

Fit #87084 or 87720 mixer

87200.....#0	87202.....#2
87201.....#1	87203.....#3
87204.....#4	87205.....#5
87207.....#7	87220.....Mixer



HARRIS STYLE OXY-ACETYLENE CUTTING TIPS

6290 series

60427.....#0	60430.....#3
60428.....#1	60431.....#4
60429.....#2	



HARRIS STYLE PROPANE CUTTING TIPS (2-PIECE STYLE)

6290 Series

60432.....#00	60435.....#2
60433.....#0	60436.....#3
60434.....#1	



87131• MODEL J63-2 HARRIS STYLE ROSEBUD HEATING TIP

Fits #87084 or 87220 Mixer



87084• MIXER ASSEMBLY FOR 1687

(use 87720 for Genuine Harris Equipment)



87220• ROSEBUD & WELDING TIP MIXER ASSEMBLY. HARRIS E-43

(For 1687 Kit see 87084)



HARRIS STYLE TIPS AND MIXERS

OXY-ACETYLENE TORCH KITS & ACCESSORIES

VICTOR TYPE HEAVY-DUTY TORCH TIPS FOR 1711 COMMANDER, 1757 SHOP FLAME (H.D.) AND VICTOR JOURNEYMAN

VICTOR TYPE HEAVY-DUTY TORCH TIPS FOR 1711 COMMANDER, 1757 SHOP FLAME (H.D.) AND VICTOR JOURNEYMAN		
Description	Victor#	Forney #
Acetylene Cutting Tip	0-1-101	60462
Acetylene Cutting Tip	1-1-101	60463
Acetylene Cutting Tip	2-1-101	60464
Acetylene Cutting Tip	3-1-101	60465
Propane Cutting Tip	1-GPN	60471
Propane Cutting Tip	2-GPN	60472
Propane Cutting Tip	3-GPN	60473
Acetylene Rosebud Tip	8-MFA	87791

VICTOR TYPE SUPER RANGE TORCH TIPS FOR FORNEY 1680/1700/1702 SHOP FLAME 1705 SHOP FLAME II AND 1753 TOTE-A-TORCH

VICTOR TYPE SUPER RANGE TORCH TIPS FOR FORNEY 1680/1700/1702 SHOP FLAME 1705 SHOP FLAME II AND 1753 TOTE-A-TORCH		
Description	Victor #	Forney #
Acetylene Cutting Tip	0-3-101	60447
Acetylene Cutting Tip	1-3-101	60448
Acetylene Cutting Tip	2-3-101	60449
Acetylene Cutting Tip	3-3-101	60450
Propane Cutting Tip	0-3-GPN	60482
Propane Cutting Tip	1-0-GPN	60483
Propane Cutting Tip	2-3-GPN	60484
Propane Cutting Tip	3-3-GPN	60485
Propane Cutting Tip	4-3-GPN	87936
Acetylene Welding Nozzle	0-ET	87822
Acetylene Welding Nozzle	1-ET	87823
Acetylene Welding Nozzle	2-ET	87824
Acetylene Rosebud Tip	8-MFA-1	87790

CUTTING GUIDE FOR ACETYLENE VICTOR TYPE TIPS Series 1-101, 3-101 & 5-101

VICTOR STYLE ACETYLENE CUTTING TIP CHART Series 1-101, 3-101 and 5-101						
Metal Thickness	Tip Size	Cutting Oxygen Pressure (PSI)	Pre-Heat Oxygen (PSI)	Acetylene Pressure (PSI)	Speed I.P.M.	Kerf Width
1/4	00	20/25	3/5	3/5	20/28	.05
3/8	0	25/30	3/5	3/5	18/26	.06
1/2	0	30/35	3/6	3/5	16/22	.06
3/4	1	30/35	4/7	3/5	15/20	.07
1	2	35/40	4/8	3/6	13/18	.09
2	3	40/45	5/10	4/8	10/12	.11

VICTOR STYLE CUTTING TIP CHART FOR PROPANE , NATURAL GAS, LPG (Series GPN)					
Metal Thickness	Tip Size	Cutting Oxygen Pressure (PSI)	Pre-Heat Fuel gas Pressure (PSI)	Speed I.P.M.	Kerf Width
1/4	00	20/25	3/5	21/25	.05
3/8	0	25/30	3/5	20/24	.06
1/2	0	30/35	3/5	18/22	.06
3/4	1	30/35	3/6	15/20	.08
1	2	35/40	3/6	14/18	.09
2	3	40/45	4/8	10/14	.10
2-1/2	3	45/50	5/9	9/12	.10

OETIKER CLAMPS

OETIKER 2 EAR CLAMPS - medium pressure for use on rubber hose, plastic tubing, co-axial and other electrical cable, rope, etc. Use on air, fluid, gas and steam hoses. Suitable for low pressure hydraulics.

INSTALL CORRECTLY

A clamp that is too tight can collapse or deform the material causing leakage. When the clamp ears can be closed all the way the clamp is normally too big and the next smaller size should be used. Close first ear, then the second. When second ear is closed, first one opens slightly and may be squeezed again. Each ear should not be squeezed more than twice.

SIZE		SIZE	
86150	1/4"	86151	5/16"
86152	3/8"	86153	7/16"
86154	1/2"	86155	9/16"
86156	5/8"	86157	3/4"
86158	7/8"	86159	15/16"
86160	1"		

86161 PLIERS FOR OETIKER CLAMPS

Provides easy application and removal of Oetiker clamps.



OXY-ACETYLENE TORCH KITS & ACCESSORIES

PUROX STYLE OXY-ACETYLENE CUTTING TIPS MEDIUM STYLE

General purpose, medium preheat cutting tips sufficient for beveling. Six preheat holes. Fit models CW 200 and CW 202. Style 4202. Cutting depth indicated.

60515.....# 3	60517.....# 7
60516.....# 5	87880.....# 9



AIRCO STYLE* OXY-ACETYLENE CUTTING TIPS

General purpose. Four preheat holes for medium preheating, machine cutting. Style 144. Also fit units using styles 164 and 138. Fit Airco Models 3790-4690-4700-5700-1100-3000-9000 and 9500

60506.....# 1	60508# 3
60507.....# 2	60509 ...Style 229, propane # 1



SMITH STYLE OXY-ACETYLENE MC 12

FOR MODELS MC 505 & 509, AC 305 AND 309. CUTTING DEPTH INDICATED

60408.....# 2 (MC 12-2)
60409.....# 3 (MC 12-3)



SMITH STYLE OXY-PROPANE CUTTING TIPS

STYLE MC 40 FOR MEDIUM-DUTY UNITS

60413.....# 2 (MC 40-2)



SMITH STYLE OXY-ACETYLENE CUTTING TIPS FOR HEAVY-DUTY UNITS.

SC SERIES TIPS NOT FOR MC SERIES TORCHES

60402.....# 1 (SC 12-1)
60403.....# 2 (SC 12-2)
60404.....# 3 (SC 12-3)



PUROX, REGO, AIRCO & SMITH STYLE CUTTING TIPS

METAL WORKING AND SHOP TOOLS

70500 CHIPPING HAMMER WITH BRUSH 70501

The king of all chipping hammers. Tempered chisel to resist dulling during heavy duty usage. Impact resistant handle. Steel wire brush for cleaning. Brush is removable, reversible and replaceable. Loop in handle for belt hook. Black 12" long.



70501 STEEL WIRE BRUSH

Replacement brush for Forney 70500 Chipping Hammer. Sturdy, high quality steel wire brushes set in hardwood with hang hole.



70600 CHIPPING HAMMER STRAIGHT HEAD

High carbon steel. Tempered flat chisel on one end. Point on the other end. Durable. All-purpose. Shock proof handle with loop for belt hook. Black. 10-1/2" long.



70601 CHIPPING HAMMER CROSS-PEEN STYLE

High carbon steel. Tempered flat chisel on one end. Point on the other end. Durable. All-purpose. Has shock proof handle with loop for belt hook. Black. 10-1/2" long.



70610 CHIPPING HAMMER STRAIGHT HEAD WOOD HANDLE

High carbon steel. Tempered flat chisel on one end. Point on the other end. Durable. All-purpose. Sturdy. Hardwood handle for comfort. 10-1/2" long.



METAL WORKING AND SHOP TOOLS

WOOD HANDLE WIRE SCRATCH BRUSHES FOR PAINT & RUST REMOVAL

Heavy-duty wire brushes. Strong, durable, solidly imbedded Carbon Steel, Brass and Stainless Steel bristles. Long or shoe handles with pre-drilled hang holes. Carbon Steel brushes especially good for aggressive cleaning, removing rust and paint from most surfaces. Stainless Steel brushes ideal for cook-out grills, dairy operations, restaurants and surfaces exposed to high humidity. Brass brushes for general purpose cleaning and excellent for cleaning Stainless Steel & Aluminum

Cat. #	Description	Wire Rows
70516	13½" Long Handle Carbon Steel w Metal Scraper	3 x 19
70504	13½" Long Handle Carbon Steel	3 x 19
70518	13½" Long Handle Brass	3 x 19
70521	13½" Long Handle Stainless	3 x 19
70517	10¼" Shoe Handle Carbon Steel W Metal Scraper	4 x 16
70505	10¼" Shoe Handle Carbon Steel W Metal Scraper	4 x 16
70519	10¼" Shoe Handle Brass	4 x 16
70520	10¼" Shoe Handle Stainless	4 x 16



70516



70518 Brass
70504 Carbon Steel
70521 Stainless Steel



70517



70519 Brass
70505 Carbon steel
70520 Stainless steel

V-GROOVE WIRE BRUSHES LONG HANDLE (3x14 ROWS)

70522 CARBON STEEL 13-1/2"

Great for cleaning tight, hard-to-reach areas: welds, concrete, driveway joints, auto body seams, removing paint in corners, etc. Hang hole in handle.

70523 STAINLESS STEEL 13-1/2"

Great for cleaning tight, hard-to-reach areas in dairy operations, restaurants, boats & areas where humidity is a problem. Ideal for cleaning most aluminum. Hang hole in handle.

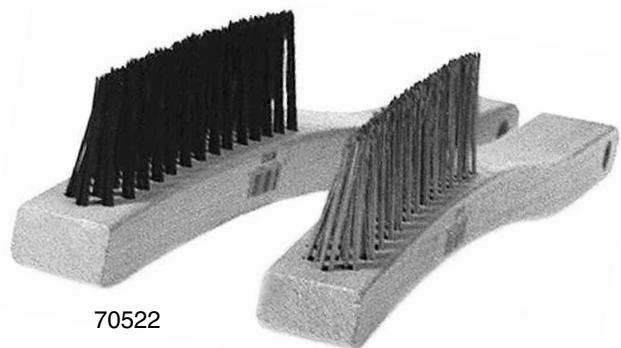

70522

70523

WIRE BRUSHES

METAL WORKING AND SHOP TOOLS

SMALL SIZE KNUCKLE SAVER STYLE BRUSHES

70488

STAINLESS STEEL WIRE BRUSH

Abrasive cleaning action. Will not rust. Plastic Handle. Hang hole in plastic handle. 7-1/4" long 3 x 7 rows.



70489 BRASS WIRE BRUSH

Abrasive cleaning action on non-ferrous materials where scratches are undesirable. Hang hole in plastic handle. 7-1/4" long 3 x 7 rows.



70490 BRASS WIRE BRUSH

Aggressive cleaning action. Will not rust. Hang hole in wooden handle. 7-1/4" long 3 x 7 rows.



70506

STAINLESS STEEL WIRE BRUSH COMPACT

General purpose cleaning, especially on aluminum. Hang hole in wooden handle. 7-3/4" long 3 x 7 rows.



MEDIUM SIZE KNUCKLE SAVER STYLE BRUSHES

70491 BRASS WIRE BRUSH

Won't scratch stainless or polished steel. Excellent for finish or delicate work. Angle-head design eliminates cut or bruised knuckles. Hang hole in wooden handle. 8-3/4" long - 2 x 9 rows.



70503 STAINLESS STEEL WIRE BRUSH

Excellent for general cleaning. Angle-head design eliminates cut and bruised knuckles. Hang hole in wooden handle. 8-3/4" long - 2 x 9 rows.



METAL WORKING AND SHOP TOOLS

STAINLESS STEEL & BRASS SCRATCH BRUSHES

NYLON TUBE BRUSH WITH WIRE HANDLE

70469 8 1/2"L x 3/4"D x 3" Brush Length

70485 8 1/2"L x 1/2"D x 3" Brush Length

Firm bristle, stiff stem brush ideal for cleaning bottles, carburetors, brake cylinders, radiator hoses, engine blocks, blocked hoses and drains, etc.



70469



70485

WIRE FITTING BRUSH WITH WIRE HANDLE

70470 6"L x 5/8"D

70484 6"L x 7/8"D

For cleaning copper fittings prior to soldering. Great for removing corrosion from battery terminals, tubing or black pipe.



70470



70484

PLASTIC HANDLED WIRE FITTING BRUSHES

70471 4-3/4"L x 1/2"D

70472 4-3/4"L x 3/4"D

For cleaning plumbing joints prior to soldering. Great for removing corrosion from battery terminals, tubing & black pipe.

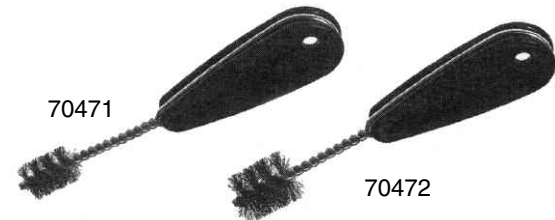

70471

70472

STAINLESS STEEL POWER TUBE BRUSHES

70473 4"L x 1/2"D

70474 4"L x 3/4"D

Insert brushes in power drill for swift & easy cleaning of plumbing joints prior to soldering. Skin-packed as a display item.



70473



70474

OUTSIDE TUBE CLEANING BRUSHES

70475 1/2" D

70476 3/4" D

Ideal for cleaning corrosion from terminals and similar cylindrical shapes.

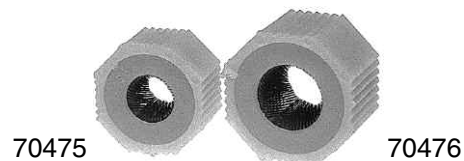

70475

70476

• Indicates a Skin-Packed display item

METAL WORKING AND SHOP TOOLS



70483 WIRE BRUSH

Solvent resistant, aggressive bristles. Wide range of cleansing applications. 5-5/16" long x 1-1/2" wide.



70507 PARTS CLEANING BRUSH ECONOMY-MEDIUM DUTY

Durable brush made entirely of polypropylene. Resistant to most auto parts cleaning solutions. One piece, unitized brush vulcanized in rubber. Size 10 brush. Overall length: 10-1/2".



70508 PARTS CLEANING BRUSH DELUXE-HEAVY DUTY

Durable brush made entirely of polypropylene. Resistant to most auto parts cleaning solutions. One piece, unitized brush vulcanized in rubber construction. Metal ferrule for more support and durability. Plus a slightly heavier fill. Size 10 brush. Overall length: 10-1/2".



70509 WIRE PARTS CLEANING BRUSH

Premium brush provides more aggressive action than nylon. Good for removing gasket material or baked on varnish. Overall length: 9"



70510 BATTERY CABLE TERMINAL BRUSH

Handy for cleaning insides of cable ends and battery posts.



70221 DELUXE MAGNETIC LEVEL

An all position—vertical, horizontal and diagonal—magnetic level. Strong lifetime magnet frees hands for work. Designed for mechanics, engineers, plumbers, sheet metal workers, electricians, carpenters, masons, hobbyists and homemakers. Patented. 90 day warrantee. 9" x 1-1/4" x 1/2". **(Blister Packed)**



70709/70710 4-WAY PICK REPAIR KIT

Handy repair kit includes four tempered steel picks: retriever pick, "O" ring remover, 90° pick and straight pick/scribe. Convenient. Durable. Built with quality. Useful for professional or handyman.

Available in 4" (70709) or 6" (70710) lengths



70714• PREMIUM SCRIBE

Useful marking tool features a handy pocket clip, knurled aluminum handle and tungsten carbide tip. Also cuts glass.



PAINT MARKER (Yellow only)

70811 SKIN-PACKED 2/CARD

Unique because it is really **Paint!** Doesn't fade. Weatherproof. Marks permanently on wet, dry, smooth or extremely rough surfaces. Even on oily, icy, slick surfaces such as lumber, plastics, ceramics, rubber, glass and **all** metals. Contains no lead or zinc compounds.

METAL WORKING AND SHOP TOOLS

SOAPSTONE PENCILS



70718

70718 COMBO SCRIBE-MAGNET

All the features of the 70714 plus a powerful Alnico magnet for metal retrieval.

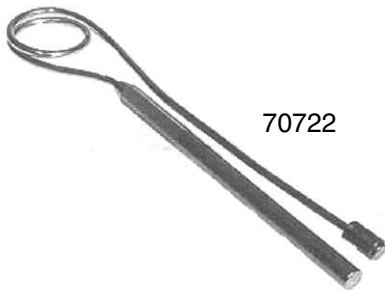

70722

70722 THIN FLEX MAGNET

Won't lose its shape going around corners. Rigid, yet can be bent to any shape. 20" overall length.



70802 SOAPSTONE PENCIL FLAT METAL HOLDER

With pocket clip. Refills: 80803, 80805 & 60306

80805.....	1 Gross Box (144)
80803.....	Single
60306 •	3 per Pkg.



70807 SOAPSTONE PENCIL ROUND ALUMINUM HOLDER

With pocket clip. Refills: 80801, 80804 & 60305

80800.....	1 Gross Box (144)
80801.....	Single
60305 •	3 per Pkg.

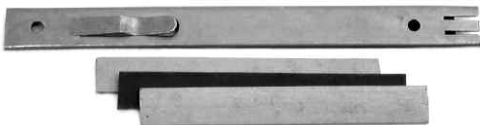

70795 THIN LINE MARKING PENCIL

Visible under heat. More break-resistant than soapstone. Makes thin lines without resharpening. Comes with 3 refills: 1 red and 2 silver.



70796 SILVER THIN LINE REFILL

Excellent for marking metals & all layout measurement work.



70797 RED THIN LINE REFILL

Excellent for light, bright or polished metals, wood and all your measurement work.

METAL WORKING AND SHOP TOOLS



70201 LOCKING PLIER STYLE C-CLAMP

Extra clamping capacity for large objects. 10-1/2" long. 3-3/4" maximum opening. 3" depth.

70202 LOCKING PLIER WITH SWIVEL PADS



70301 LOCKING PLIER STYLE WELDING CLAMP

Designed to grip a few inches from end of metal. Allows weld to start or finish at end of joint. Plated steel construction. 2" maximum jaw opening. 8-3/8" long. 2-1/2"-3" depth.



70235 LOCKING PLIER STYLE CHAIN CLAMP

Designed to grip anything the chain can be wrapped around. Releases with the flick of a finger. Ideal for pipes and awkward shaped items.



MALLEABLE IRON C-CLAMPS 3" & 4"

High quality C-clamp for light industrial use. Malleable cast metal frame. Copper plated screw, Swivel pad and Sliding T- handle.

70226 / 70227

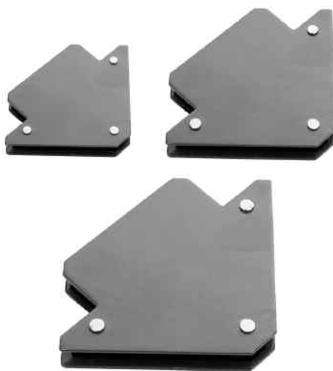

MULTI-PURPOSE MAGNETS

70716 SMALL

70717 LARGE

70715 X-LARGE

These strong magnets stick to any iron object. Magnets have 45, 90 & 135 degree angles. Excellent "3rd Hand" for welding, soldering, assembly, pipe installation, marking, floating and separating thin metal stacks. Hole in 70717 is for crane mounted lifting of small items.

(CAUTION: MAGNETS ARE NOT FOR OVERHEAD USE.)

METAL WORKING AND SHOP TOOLS

HACKSAWS, BLADES & SCREWDRIVER BITS

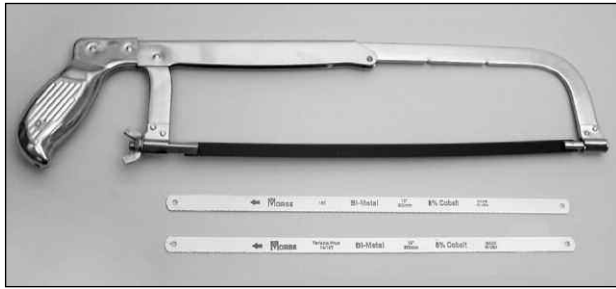

73000 HACKSAW FRAME & BLADE

Sturdy, adjustable frame. Fits all standard length blades. Lightweight and strong. Complete with one blade.

HACKSAW BLADES (Made in the U.S.A.)

*Variable tooth blades bring teeth into the work at constantly changing angles for faster, smoother and quieter cutting.

Cat#	Size	Teeth/In.
72005	12" Bi-Metal	18
72006	12" Bi-Metal	24
72007	12" Bi-Metal	32

POWER HACKSAW BLADES

Redstripe Molybdenum High Speed Steel For general purpose cut-off jobs in powered machines. Solid high-speed steel, hardened from top edge to cutting edge for maximum hardness and rigidity. Long wear life and top performance in sawing a wide range of material including stainless and tough to cut alloy steels.

8224012" x 5/8" x 14 Teeth	82243 12" x 1" x 14 Teeth
82241 12" x 5/8" x 18 Teeth	82245 14" x 1" x 14 Teeth

1/4" HEX SHANK POWER DRIVEN SCREWDRIVER BITS AND NUTSETTERS

Premium Hardened Steel. Made to Exacting Specifications.



70730

Square Recess Insert Bits 1" Long

CAT #	Size
70730	Insert # 1
70731	Insert # 2



70755

70755 # 2 Phillips Drywall Bit 1" Long



70735

Square Recess Power Bits 2" Long

CAT #	Size
70735	Power Insert # 1
70736	Power Insert # 2
80760	Power Insert # 3

METAL WORKING AND SHOP TOOLS

CAT #	Phillips Power Bits 2" Long
70762	Insert # 1
70763	Insert # 2
80771	Insert # 3



CAT #	Phillips Insert Bits 1" Long
70756	Insert # 1
70757	Insert # 2
70758	Insert # 3



CAT #	Flat Insert Bits 1" Long
80766	3/32" x 1" Insert # 4
80767	1/4" x 1" Insert # 6
80768	9/32" x 1" Insert # 8



CAT #	Magnetic Nut Setters
70770	1/4" Nut Setter 1-3/4" Long
70771	5/16" Nut Setter 1-3/4" Long
80753	3/8" Nut Setter 1-3/4" Long
80754	7/16" Nut Setter 1-3/4" Long



80753

70773 Bit Holder 1/4" x 3"



80762 1/4" x 2" Extension



70738	T10 x 1" Torx Insert Bit
70739	T15 x 1" Torx Insert Bit
70740	T20 x 1" Torx Insert Bit
70741	T25 x 1" Torx Insert Bit
70742	T30 x 1" Torx Insert Bit
70743	T40 x 1" Torx Insert Bit

FILES AND ACCESSORIES

Forney Files

Are heat treated for maximum performance, give perfect service for all filing needs. Are manufactured in Switzerland. They are available in a variety of sizes, styles and shapes for all of your filing needs.

2 Files	2 Files + handle	Dimensions
70365	70366	Round File 8" 5/32"
70367	70368	Round File 8" 11/64"
70369	70370	Round File 8" 3/16"
70371	70372	Round File 8" 13/64"
70373	70374	Round File 8" 7/32"



70375 6" Flat Chain Saw File
70376 8" Flat Chain Saw File



70375

70405 WOODEN FILE HANDLE

(Not Illustrated)

70395 PLASTIC CHAIN SAW HANDLE

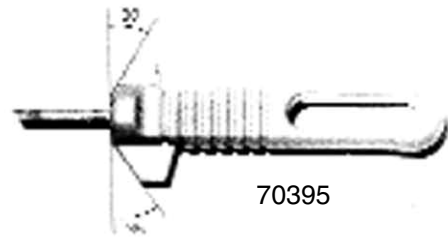

70395

Forney Machinist's Files

70377	1 Side Bastard & 1 Side Smooth	Farmer File	8"
70378		Farmer File	10"
70379		Flat Bastard File	8"
70380		Flat Bastard File	10"
70381		Flat Bastard File	12"
70384		Half Round Bastard File	8"
70385		Half Round Bastard File	10"
70386		Half Round Bastard File	12"
70382		Flat Smooth File	8"
70383		Flat Smooth File	10"
70387		Round Bastard File	8"
70388		Round Bastard File	10"
70389		Round Smooth File	8"
70390		Square Bastard File	10"
70391		Triangular Tapered Saw File	6"
70392		Half Round Bastard Rasp	10"
70393		Half Round Bastard Rasp	12"
70394		Contact Point File (2 pack)	

Chain Saw File Handle

Plastic file handle, with built in angle guide & suspension hole.

70396 Handle for 6" and 8"
70397 Handle for 8" and 10"
70398 Handle for 12"



70396

FILES AND ACCESSORIES

70360 - ENGINEER'S OPENING FILE INVENTORY

Contains one each of the following items.

70365	70376	70386	70396
70366	70377	70387	70397
70367	70378	70388	70398
70368	70379	70389	70399
70369	70380	70390	70400
70370	70381	70391	70401
70371	70382	70392	70402
70372	70383	70393	70403
70373	70384	70394 (2)	70404
70374	70385	70395	70405
70375			
42 Items			



70361

70361 - CHAIN SAW FILE OPENING INVENTORY

Contains one each of the following items.

70365	70366	70367	70368
70369	70370	70371	70372
70373	70374	70375	70376
70395			70405
14 Items			

70362 - MACHINIST'S FILE OPENING INVENTORY

Contains one each of the following items.

70377	70381	70385	70389	70394	70400
70378	70382	70386	70390	70395	70401
70379	70383	70387	70391	70396	70402
70380	70384	70388	70392	70397	70403
			70393	70398	70404
			70399		
28 Items					

70401	Mill File 6"
70399	Mill File 8"
70402	Extra Slim Taper Saw File 6"
70403	Half Round Rasp 8"
70404	Universal File 6"

70362



UTILITY HARDWARE CENTRE

WIRE ROPE CLIPS, THIMBLES, SHUTS, REPAIR & QUICK LINKS



WARNING: Observe all Maximum Working Load Limits listed on this notice for the specific products being used. Never exceed these limits. Overhead lifting or support of human weight requires special chain and accessories not available from Forney Industries. Inspect chain and accessories frequently and replace worn or stressed components with new product.

Wire Rope Clips, Links & Shuts allow Farmers, Garages, Service Stations, Shops & (Do-It-Yourselfers) to repair broken chains instead of replacing them. Steel Wire Rope Clips come Galvanized or Plated. Steel Quick Links, Repair Links, Cold Shuts & Thimbles also are Galvanized. **This prevents rust.**

UTILITY HARDWARE CENTRE LOZIER DISPLAY 61000—INCLUDES EIGHT 12"X24" POG'S WITH FULL DESCRIPTIONS, CAT #'S & BAR CODES: 61001 SMALL HOOK CENTRE, 61002 LARGE HOOK CENTRE, 61003 LINKING CENTRE, 61004 CLEVIS LINKS, SHACKLES & SWIVELS CENTRE, 61005 U-BOLTS CENTRE, 61006 EYE BOLTS, LAG EYES, & SCREW HOOKS CENTRE, 61007 SNAP HOOKS CENTRE, 61008 TURNBUCKLE CENTRE. THE FORNEY SPINNER RACK DISPLAY INCLUDES OPENING INVENTORY 61000 & SPINNER RACK 10279.

Linking Centre— 61003: includes POG 10602

WIRE ROPE CLIPS (Galvanized)		DIMENSIONS								
#	CAT	Gr.	A	B	C	D	E	G	H	#
61010	1/8"	7/32"	23/32"	7/16"	15/32"	13/32"	13/16"	15/16"		
61011	3/16	1/4	31/32	9/16	19/32	1/2	15/16	1-5/32		
61012	1/4	5/16	1-1/32	1/2	3/4	21/32	1-3/16	1-7/16		
61013	5/16	3/8	1-3/8	3/4	7/8	23/32	1-5/16	1-11/16		
61014	3/8	7/16	1-1/2	3/4	1	29/32	1-5/8	1-15/16		
61015	7/16	1/2	1-7/8	1	1-3/16	1-1/32	1-13/16	2-9/32		
61016	1/2	1/2	1-7/8	1	1-3/16	1-1/8	2-29/32	2-9/32		

WIRE ROPE CLIPS		DIMENSIONS								
#	CAT	Gr.	A	B	C	D	E	G	H	#
61020	1/8"	7/8"	7/16"	9/16"	1/4"	15/32"	7/16"	3/4"		
61021	3/16	1-1/16	1/2	19/32	1/4	18/32	21/32	15/16		
61022	1/4	1-1/4	19/32	23/32	5/16	21/32	3/4	1-1/4		
61023	5/16	1-3/8	5/8	3/4	5/16	23/32	7/8	1-5/16		
61024	3/8	1-19/32	7/8	7/8	3/8	25/32	1-1/16	1-5/8		
61025	1/2	1-29/32	7/8	1	15/32	1-1/16	1-3/8	2-1/8		

COLD SHUT		DIMENSIONS				
		CAT#	Rope Dia.	Inside width	Inside lgth	Wt lbs
		61090	3/16"	11/32"	15/16"	.03
		61091	1/4	3/8	1-3/16	.06
		61092	5/16	7/16	1-3/8	.1
		61093	3/8	5/8	1-1/2	.18
		61094	7/16	11/16	1-9/16	.26
		61095	1/2	3/4	1-7/8	.38

REPAIR LINKS		DIMENSIONS				
		CAT#	Rope Dia.	D2	H1	M
		61110	3/16	3/8	15/16	1/4
		61111	1/4	13/32	15/16	9/32
		61112	5/16	5/8	1-7/16	3/8
		61113	3/8	21/32	1-15/32	3/8
		61114	7/16	11/16	1-15/32	3/8

WIRE ROPE THIMBLE		DIMENSIONS							
		CAT#	Rope Dia.	A	B	C	D	E	F
		61030	1/8"	1-15/16"	1-1/16"	1-5/16"	11/16"	5/32"	5/8"
		61031	3/16	1-15/16	1-1/16	1-5/16	11/16	7/32	5/8
		61032	1/4	1-15/16	1-1/16	1-5/16	11/16	9/32	5/8
		61033	5/16	2-1/8	1-1/4	1-1/2	13/16	3/8	3/4
		61034	3/8	2-3/8	1-15/32	1-5/8	15/16	7/16	7/8
		61035	1/2	2-3/4	1-3/4	1-7/8	1-1/8	9/16	1 1/16

QUICK LINK		DIMENSIONS				
		CAT#	Size	B1	B2	H1
		61120	3/16"	13/32"	3/16"	1-1/8"
		61121	1/4	9/16	1/4	1-1/2
		61122	5/16	9/16	9/32	1-3/4
		61123	3/8	5/8	5/16	2-1/16
		61124	7/16	25/32	15/32	2-11/16
		61125	1/2	31/32	19/32	3-1/4

UTILITY HARDWARE CENTRE

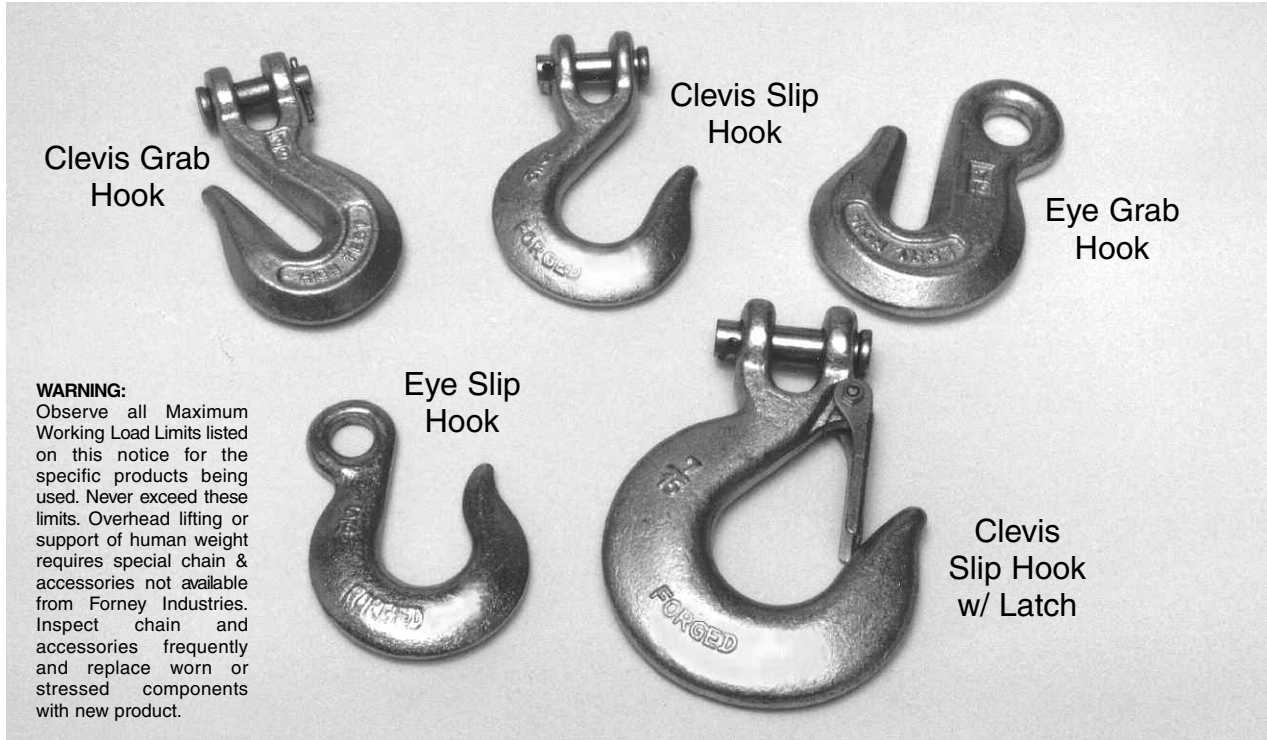

Clevis Grab Hook

Clevis Slip Hook

Eye Grab Hook

Eye Slip Hook

Clevis Slip Hook w/ Latch

WARNING:
Observe all Maximum Working Load Limits listed on this notice for the specific products being used. Never exceed these limits. Overhead lifting or support of human weight requires special chain & accessories not available from Forney Industries. Inspect chain and accessories frequently and replace worn or stressed components with new product.

SLIP, GRAB AND EYE HOOKS

Eye, Slip & Grab Hooks Tempered from Forged carbon Steel. Working Load from 1,950 pounds to 9,200 pounds. Five Styles: Clevis Grab Hooks; Clevis Slip Hooks; Eye Grab Hooks; Eye Slip Hooks & Clevis Slip Hooks with Latches. The Hook for practically any job. **Galvanized to prevent rust.**

Opening Inventory—Small Hook centre 61001: includes POG 10600
Opening Inventory—Large Hook centre 61002: includes POG 10601

EYE GRAB HOOK	Diagram			Max Working Load	DIMENSIONS			
		# CAT	Grand.		B	E	R	/ lbs
		61060	1/4	2,600	.50	.34	1.97	.28
		61061	5/16	3,900	.56	.44	2.25	.45
		61062	3/8	5,400	.66	.50	2.56	.79
		61063	7/16	7,200	.75	.56	2.94	1.19
		61064	1/2	9,200	.88	.66	3.38	1.8

CLEVIS GRAB HOOK	Diagram			Max Working Load	DIMENSIONS				
		# CAT	Grand.		B	E	P	R	/ lbs
		61040	1/4	2,600	.36	.40	.38	1.97	.40
		61041	5/16	3,900	.40	.44	.44	2.26	.79
		61042	3/8	5,400	.48	.50	.47	2.63	1.0
		61043	7/16	7,200	.66	.56	.56	2.75	1.5
		61044	1/2	9,200	.75	.66	.63	3.19	2.1
		61037	1/4	Grade 70					
		61038	5/16	Grade 70					
		61039	3/8	Grade 70					

EYE SLIP HOOK	Diagram			Max Working Load	DIMENSIONS			
		CAT#	Size		B	E	R	/ lbs
		61070	1/4	1,950	.50	.94	2.56	.40
		61071	5/16	2,875	.63	1.06	2.95	.70
		61072	3/8	4,000	.72	1.31	3.36	1.0
		61073	7/16	5,000	.81	1.56	3.88	1.6
		61074	1/2	6,500	.94	1.69	4.28	2.4

CLEVIS SLIP HOOK	Diagram			Max Working Load	DIMENSIONS				
		# CAT	Grand.		B	E	P	R	/ lbs
		61050	1/4	1,950	.44	.94	.38	2.56	.50
		61051	5/16	2,875	.50	1.06	.44	2.87	.75
		61052	3/8	4,000	.59	1.31	.47	3.25	1.20
		61053	7/16	5,000	.66	1.56	.56	3.70	2.06
		61054	1/2	6,500	.76	1.69	.63	4.0	2.8

CLEVIS SLIP HOOK	Diagram			Max Working Load	DIMENSIONS					
		# CAT	Grand.		B	E	P	R	T	/ lbs
		61080	1/4	2,750	.44	.79	.38	2.56	.79	.52
		61081	5/16	4,300	.50	.93	.44	2.87	.79	.77
		61082	3/8	5,250	.59	1.14	.47	3.25	1.02	1.23
		61083	7/16	7,000	.66	1.18	.56	3.7	1.06	2.1
		61084	1/2	9,000	.75	1.42	.63	4.0	1.38	2.85
		61085	1/4	2,750	.44	.79	.38	2.56	.79	.52
		61086	5/16	4,300	.50	.93	.44	2.87	.79	.77
		61087	3/8	5,250	.59	1.14	.47	3.25	1.02	1.23



UTILITY HARDWARE CENTRE

WARNING: Observe all Maximum Working Load Limits listed on this notice for the specific products being used. Never exceed these limits. Overhead lifting or support of human weight requires special chain & accessories not available from Forney Industries. Inspect chain & accessories frequently & replace worn or stressed components with new product.

Twin Clevis Link



Forged Swivel



Jaw End Swivel



Screw Pin Shackle



Clevis Pin Shackle



SHACKLES, SWIVELS AND CLEVISES

Clevises, Shackles & Swivels are made from **Forged Heat Treated Steel**. Pins are Alloy Steel. Maximum Working Loads in Pounds. **Galvanized to prevent rust.**

Opening Inventory-61004: Clevis links, Shackles & swivels centre-includes POG 10603

JAW END SWIVEL	SIZE		Max Working Load	DIMENSIONS						
	# CAT	SIZE		A	B	C	K	N	P	R
	61150	1/4"	850	1-1/4"	11/16"	3/4"	15/32"	7/8"	1/4"	2-5/8"
	61151	5/16"	1,250	1-5/8"	13/16"	1	1/2"	7/8"	5/16"	2-15/16"
	61152	3/8"	2,250	2	15/16"	1-1/4"	5/8"	1-1/16"	3/8"	3-5/8"
	61153	1/2"	3,650	2-1/2"	1-5/16"	1-1/2"	3/4"	1-5/16"	1/2"	4-1/2"

TWIN CLEVIS	SIZE		Max Working Load	DIMENSIONS				
	# CAT	SIZE		A	R	D	G / lbs	
	61130	1/4-5/16"	4,700	.47	1.18	.38	.43	.32
	61131	3/8"	6,600	.53	1.34	.47	.48	.44
	61132	7/16-1/2"	11,250	.65	1.75	.56	.63	1.0

SCREW PIN SHACKLE	SIZE		Max Working Load	DIMENSIONS				
	# CAT	SIZE		L	WTH	WB	DP	DE
	61160	3/16"	666	7/8"	3/8"	11/16"	1/4"	9/16"
	61161	1/4"	1,000	1-1/8"	1/2"	25/32"	5/16"	11/16"
	61162	5/16"	1,500	1-7/32"	17/32"	27/32"	3/8"	13/16"
	61163	3/8"	2,000	1-7/16"	21/32"	1-1/32"	7/16"	31/32"
	61164	7/16"	3,000	1-11/16"	23/32"	1-5/32"	1/2"	1-1/16"
	61165	1/2"	4,000	1-7/8"	13/16"	1-5/16"	5/8"	1-3/16"

FORGED SWIVEL	SIZE		Max Working Load	DIMENSIONS				
	# CAT	SIZE		A	B	C	D	R
	61140	1/4"	850	1-1/4"	11/16"	3/4"	1-1/16"	2-5/16"
	61141	5/16"	1,250	1-5/8"	13/16"	1	1-1/4"	3-9/16"
	61142	3/8"	2,250	2	15/16"	1-1/4"	1-1/2"	4-5/16"
	61143	1/2"	3,600	2-1/2"	1-5/16"	1-1/2"	2	5-7/16"

CLEVIS PIN SHACKLE	SIZE		Max Working Load	DIMENSIONS				
	# CAT	SIZE		L	WTH	WB	DP	DE
	61170	3/16"	666	7/8"	3/8"	11/16"	1/4"	9/16"
	61171	1/4"	1,000	1-1/8"	1/2"	25/32"	5/16"	11/16"
	61172	5/16"	1,500	17/32"	17/32"	27/32"	3/8"	13/16"
	61173	3/8"	2,000	15/32"	21/32"	1-1/32"	7/16"	31/32"
	61174	7/16"	3,000	23/32"	23/32"	1-5/32"	1/2"	1-1/16"
	61175	1/2"	4,000	13/16"	13/16"	1-5/16"	5/8"	1-3/16"

UTILITY HARDWARE CENTRE

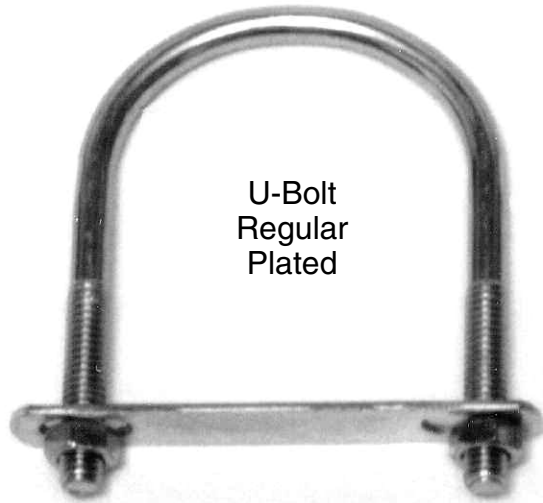

U-Bolt
Regular
Plated

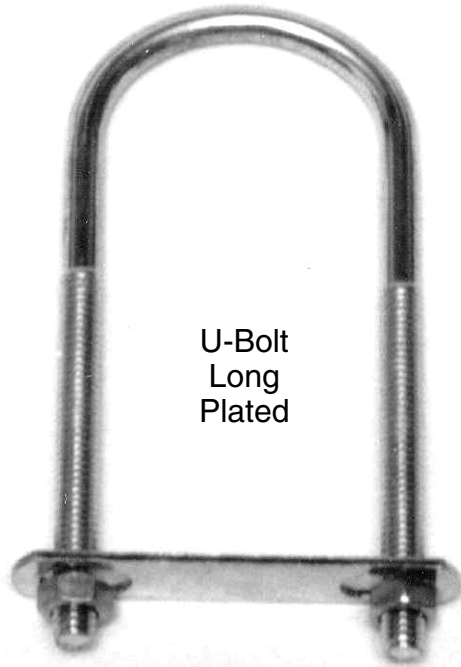

U-Bolt
Long
Plated

Virtually any size to satisfy the needs of any job for Do-It-Yourselfers, Contractors, Carpenters or Auto Mechanics.

Opening Inventory for U-Bolt Centre-61005: includes POG 10604

U-BOLTS PLATED REG.	DIMENSIONS						
	CAT#	PIPE SIZE	Thd lgth	Thd dia	Btw legs	Inside lgth	
	61180	1/4"	3/4"	1/4"	9/16"	1-3/8"	
	61182	1/2	7/8	1/4	1	1-3/4	
	61183	3/4	1-1/8	1/4	1-1/8	2	
	61184	1	1-1/8	1/4	1-1/2	2-3/4	
	61185	1-1/2	1-5/8	1/4	2	3-1/2	
	61186	1	1-1/4	5/16	1-1/2	2-1/2	
	61187	1-1/4	1-3/8	5/16	1-3/4	3	
	61188	1-1/2	1-3/8	5/16	2	3	
	61189	2	1-3/8	5/16	2-1/2	3-1/2	
	61193	2	1-1/4	3/8	2-1/2	3-1/2	
	61194	2-1/2	1-1/4	3/8	3	4	
	61195	3	1-1/4	3/8	3-1/2	4-1/2	
		61200	1	2	5/16	1-3/8	3-5/8
		61201	1-1/4	2-1/2	5/16	1-3/4	4-1/8
61202		1-1/2	2	5/16	2	3-5/8	
61203		1-1/2	2-1/2	5/16	2	4-5/8	
61204		2	2-1/2	5/16	2-1/2	4-1/8	
61205		2	2-1/2	5/16	2-1/2	5-1/8	

PLATED U-BOLTS

UTILITY HARDWARE CENTRE

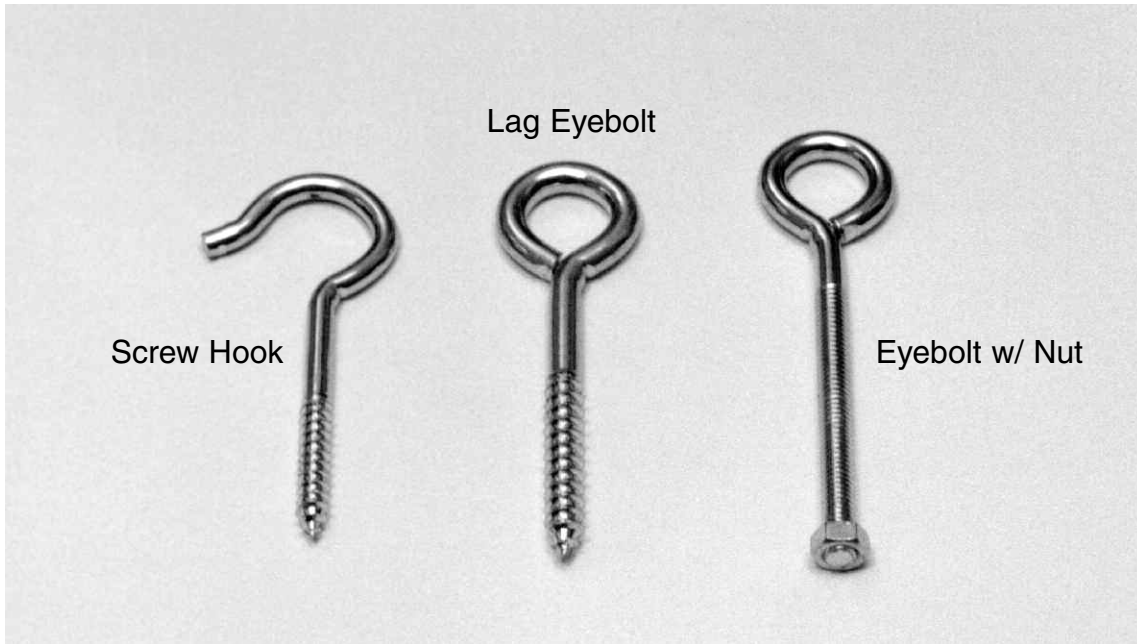

Screw Hooks, Lag Eye Bolts or Eye Bolts with Nut for Any Job
Do-It-Yourselfers, Contractors or Carpenters may have.

Opening Inventory-61006: includes POG 10605

PLATED SCREWHOOK		DIMENSIONS			
		CAT#	O.A. Length	THD. Length	Screw Size
		61210	2-1/16"	5/8"	#10
		61211	2-9/16	7/8	#8
		61212	3-3/8	1-1/8	#6
		61213	3-7/8	1-1/4	#4
		61214	4-1/8	1-1/2	#3
		61215	4-7/16	1-3/8	#2
		61216	5	1-1/2	#0

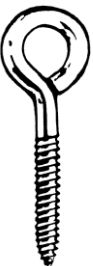
PLATED SCREW EYE		DIMENSIONS					
		CAT#	Thd Dia	O.A. Lgth	Shank Lgth	Thd Lgth	Eye ID
		61230	1/4"	3"	2"	1-1/4"	9/16"
		61231	1/4	3-3/4	3-1/4	2	9/16
		61232	1/4	5	4	2	9/16
		61233	5/16	4	2-5/8	2	3/4
		61235	5/16	6	4-5/8	2	3/4
		61236	3/8	3	2-1/8	2	1-1/8
		61237	3/8	4-1/2	2-5/8	2	1-1/8
		61239	3/8	6	4-1/8	2	1-1/8

EYE BOLT w/Nut		DIMENSIONS					
		CAT#	Thd Dia	O.A. Lgth	Shank Lgth	Thd Lgth	Eye ID
		61240	3/16	1-1/2"	1"	7/8"	5/16"
		61241	3/16	2	1-5/16	1-1/4	5/16
		61242	3/16	3	2-1/4	2	1/2
		61243	1/4	2	1-1/4	1	3/8
		61244	1/4	3	2-1/4	2	3/8
		61245	1/4	4	3	2	9/16
		61246	1/4	5	4	2-7/8	9/16
		61247	1/4	6	5	2-7/8	9/16
		61248	5/16	3	2-1/4	1-7/8	1/2
		61249	5/16	4	2-5/8	2	3/4
		61250	5/16	5	3-5/8	2-7/8	3/4
		61251	5/16	6	4-5/8	2-7/8	3/4
		61252	3/8	4	2-1/2	2-1/8	5/8
		61253	3/8	5	3-1/4	2-7/8	1
		61254	3/8	6	4-1/4	3-7/8	1
		61255	3/8	8	6-1/4	3-7/8	1
		61257	1/2	6	4	3-7/8	1-1/4
		61258	1/2	8	5-3/4	3-7/8	1-1/4

UTILITY HARDWARE CENTRE



Our Complete Line of Snaps are Made of Die Cast Zinc Alloy and Plated to Prevent Rust.

Opening Inventory Snap Hook Centre 61007 includes POG 10606

RD. EYE SNAP HOOK (Plated)	CAT#	DIMENSIONS						
		Eye	Length	Mouth				
	61260	3/8"	2"	3/16"				
	61261	1/2	2-1/2"	3/16				
	61262	1/2	3	7/32				
	61263	5/8	3	5/16				
	61264	5/8	3-1/2	3/8				
SQUARE EYE SNAP HOOK (Plated)	CAT#	Eye	Length	Mouth				
					61265	1/2"	2"	3/16"
					61266	5/8	2-1/2"	7/32
					61267	5/8	2-3/4	5/16
					61268	3/4	2-7/8	3/8
61269	1	3-1/8	7/16					
RD. EYE SPRING SNAP HOOK (Plated)	# CAT	A-Eye	L-Longueur	M-Mouth				
					61270	1/2"	3-1/8"	7/16"
					61271	5/8	3-1/4	7/16
					61272	3/4	3-3/8	7/16
					61277	9/16	1-7/8	1/4
SQUARE EYE SPRING SNAP HK. (Plated)	CAT#	Eye	Length	Mouth				
					61273	3/4	3-3/8	7/16
61276	9/16	1-3/4	1/4					

RD. EYE, SWIVEL TRIGGER SNAP HOOK (Plated)	CAT#	DIMENSIONS						
		Eye	Length	Mouth				
	61280	3/4"	3-3/4"	5/8"				
	61282	9/16	2	3/16				
	61283	5/8	2-3/8	3/8				
SQ. EYE, SWIVEL TRIGGER SNAP HK.	CAT#	Eye	Length	Mouth				
					61281	1	3-5/8	5/8
61284	3/4	2-5/8	3/8					
DOUBLE ROUND EYE SWIVEL (Plated)	# CAT	Eye	Length	Mouth				
					61287	1/2"	N/A	N/A
					61288	5/8	N/A	N/A
					61289	3/4	N/A	N/A
					61290	1	N/A	N/A
Twin Sq Eye Swivel (Plated)	CAT#	Eye	Length	Mouth				
					61293	1"x1"	N/A	N/A
DOUBLE SNAP HOOK (Plated) Reg.	CAT#	Eye	Length	Mouth				
					61295	3/8	3-1/2"	3/8"
					61296	3/8	4	7/16
					61297	1/2	4-5/8	1/2
DOUBLE SNAP HOOK (Plated) Heavy Duty	CAT#	Eye	Length	Mouth				
					61298	3/8	3-1/2	3/8
					61299	3/8	4	7/16
61300	1/2	4-5/8	1/2					

SNAP HOOKS

UTILITY HARDWARE CENTRE

TURNBUCKLES

Eight Forged Steel Body and Steel Hook & Eye Turnbuckles ranging from 1/4" to 3/4". Work Load Limits from 400# to 3,000#.

Four Multi-Purpose Die Cast Body and Steel Hook & Eye Turnbuckles Ranging from 3/16" to 3/8".

Turnbuckles are Galvanized to prevent rust.

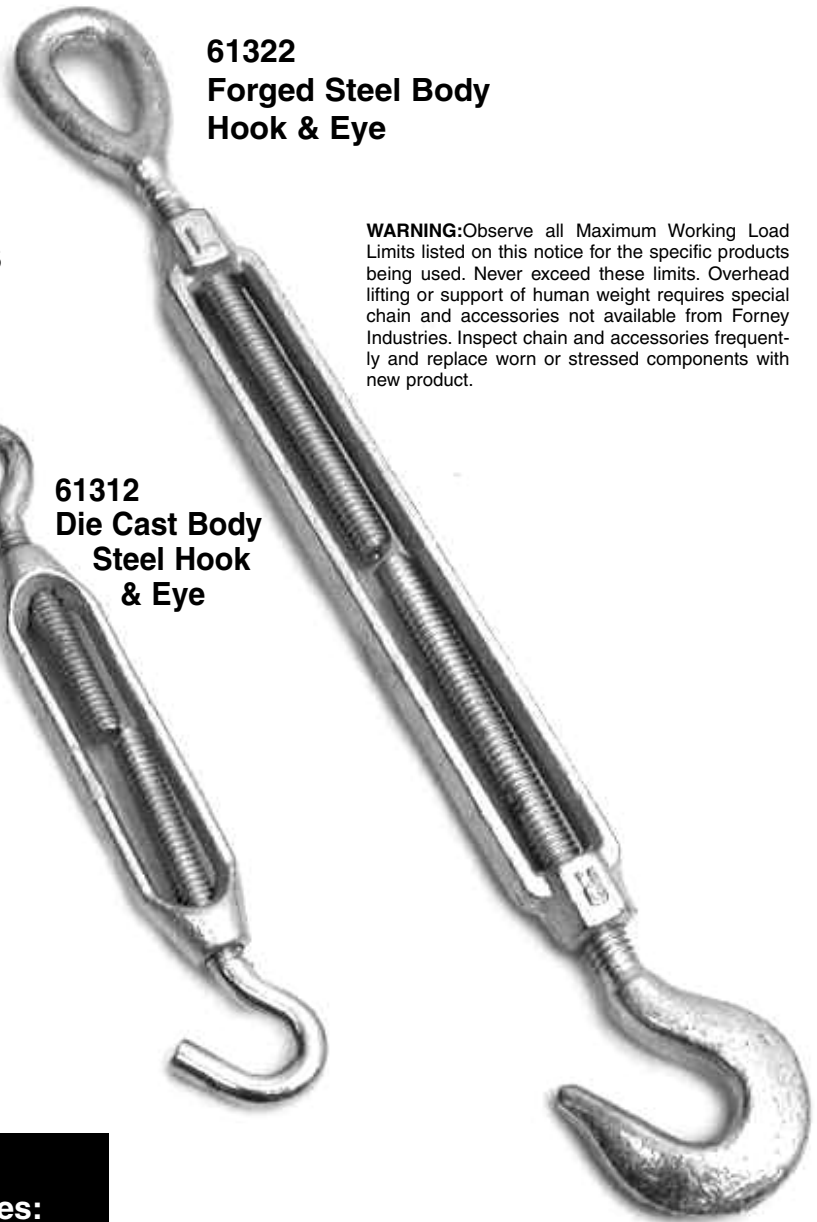

61322
Forged Steel Body
Hook & Eye

61312
Die Cast Body
Steel Hook
& Eye

WARNING: Observe all Maximum Working Load Limits listed on this notice for the specific products being used. Never exceed these limits. Overhead lifting or support of human weight requires special chain and accessories not available from Forney Industries. Inspect chain and accessories frequently and replace worn or stressed components with new product.

**Opening Inventory
Turnbuckles-61008 includes:
POG 10607**

Die Cast Body Steel Hook & Eye	CAT#	Size	DIMENSIONS			
			L1	L 2	B	M
	61310	3/16"	2-3/16"	1-3/4"	5/16"	9/32"
	61311	1/4	3-1/8	2-1/32	13/32	11/32
	61312	5/16	3-11/16	2-3/8	15/32	7/16
	61313	3/8	4-1/16	2-3/4	9/16	1/2

Forged Steel Body Steel Hook & Eye	CAT#	Size	Working Load	DIMENSIONS		
				L1	Length	Wt
	61320	1/4"	400	4"	8-1/4"	.3
	61321	5/16	700	4-1/2	9-9/16	.5
	61322	3/8	1,000	6	11-7/8	.75
	61323	1/2	1,500	6	13-5/16	1.5
	61324	1/2	1,500	9	16-5/16	1.75
	61325	1/2	1,500	12	19-5/16	2.18
	61326	5/8	2,250	8	15-1/2	2.63
	61327	3/4	3,000	8	17	3.75

DISKS FOR ANGLE GRINDERS

GRINDING WHEELS FOR ANGLE HEAD GRINDERS

Aluminum oxide metal-cutting wheels. Designed for metal-cutting, metal abrasion, body work, metal fabrication, weld grinding & general repair work. Abrasive wheels must wear away gradually to stay "sharp" and perform properly. Proper balance of hardness and rates of wear, give most economical performance. Manufactured entirely of top grade materials. Tested to meet all safety code requirements. Some general purpose wheels have patented throw away hub. Rate of wear or life of the wheel determined by the type of bonding material (hardness) in the wheel. A wheel with proper hardness will wear away just fast enough to remain "sharp". An excessively hard wheel will become dull & glazed because it doesn't wear away fast enough & therefore will cut slowly and waste your time.

TYPE 27 ABRASIVE WHEEL HUBLESS

General Purpose, 24 grit Aluminum Oxide. Fiberglass Reinforced.

Cat.	SIZE	Max. rpm
71810	4" x 1/16" x 5/8"	15,300
71812	4 1/2" x 1/16" x 7/8"	13,300
71825	5" x 1/16" x 7/8"	12,300
71828	7" x 1/16" x 7/8"	8,500
74312	4" x 1/8" x 5/8"	15,300
74311	4 1/2" X 1/8" x 7/8"	13,500
74313	5" x 1/8" x 7/8"	12,200
74315	9" x 1/8" x 7/8"	6,600
74314	7" x 1/8" x 7/8"	8,600
72307	4" x 1/4" x 5/8"	15,300
72308	4 1/2" x 1/4" x 7/8"	13,300
82333	5" x 1/4" x 7/8"	13,300
82330	7" x 1/4" x 7/8"	8,500
82332	9" x 1/4" x 7/8"	6,500



74312



82331



82334

TYPE 27 ABRASIVE WHEEL WITH HUB

General Purpose, 24 grit Aluminum Oxide. Fiberglass Reinforced.

Cat. #	SIZE	Max. rpm
82331	7" x 1/4" x 5/8" - 11NC	8,500

TYPE 28 ABRASIVE WHEEL WITH HUB

General Purpose, 24 grit Aluminum Oxide. Fiberglass Reinforced.

Cat. #	SIZE	Max. rpm
82334	7" x 1/4" x 7/8"	8,600
71826	7" x 1/4" x 5/8" - 11NC	8,600

GRINDING WHEEL ACCESSORIES

82326 RE-USABLE WHEEL ADAPTER

For hubless, depressed centre, abrasive wheels, 5/8" - 11NC with locking nut and allen wrench.

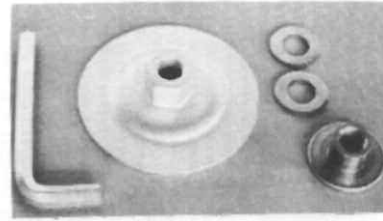

82327 NON-RE-USABLE WHEEL ADAPTER

Adapter for all 7" and 9" grinder Depressed Centre Wheels. 5/8" - 11 NC

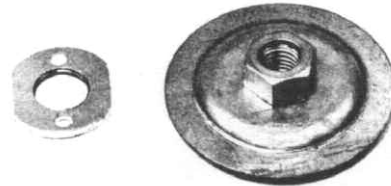

SPECIAL APPLICATION

These discs are designed not to plug up when used for cutting concrete and other soft materials such as animal hoofs etc. #24 grit.

Cat. #	SIZE	Grain	Max. rpm
82295	4-1/2"x 7/8"	24	13,700
82297	7" x 7/8"	24	8,500
82298	5" x 7/8"	24	8,500

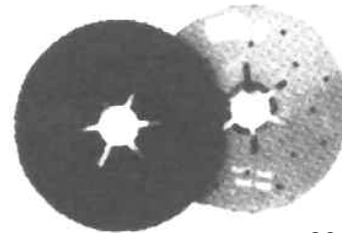

82295

72386 MANDREL SET

Suited for small cut-off wheels with 1/4 and 3/8 arbors, 1/4" shank



72386

71798 CUT - OFF WHEEL KIT

Three 3" cut-off wheels (3" x 1/16" x 1/4" , 3" x 1/16" x 3/8" and 3" x 1/8" x 1/4") and drill adapter mandrel. Skin packed.



71798

Wear eye & face protection when using power wheels.

ABRASIVE FLAP DISCS

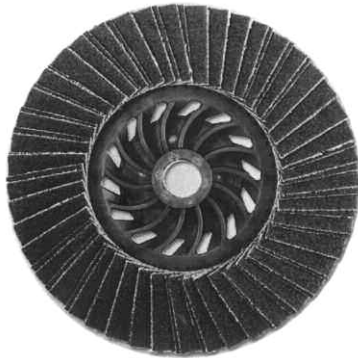

XForce Turbo Discs - Trimmable

Cat. #	Diameter	Grit
71970	4 1/2" (5/8"-11")	40
71971	4 1/2" (5/8"-11")	60
71972	4 1/2" (5/8"-11")	80
71973	4 1/2" (5/8"-11")	120
71976	5" (5/8"-11")	40
71977	5" (5/8"-11")	60
71978	5" (5/8"-11")	80
71979	5" (5/8"-11")	120

Xforce turbo discs are made using a **double** flap configuration which means there is more zirconium sandpaper coming in contact with the material you are working on. This also provides an **excellent removal** rate and does not affect the **life** of the disc.

71969 TURBO FLAP WHEEL DISPLAY (24 pc)

4 ea. of 71970, 71971, 71972, 71973
2 ea. of 71976, 71977, 71978, 71979

ABRASIVE FLAP DISCS

High Speed Flap Discs

TYPE 29 (CONICAL) MAX. RPM 13,500

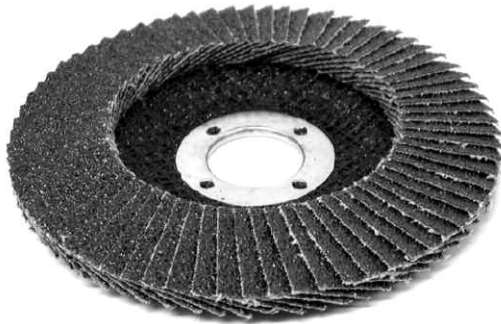

BLUE ZIRCONIA FLAP DISCS

For 4" & 4-1/2" Angle Grinders. Cut Fast & Outlast Sanding Discs 10 to 1. Great Flexibility. Ideal for Rough or Fine Finishing.*High Density Discs Ideal for Extra Tough Jobs.

Cat. #	Diameter	Arbor Size	Grit
71985	4 1/2"	7/8"	40
71986	4 1/2"	7/8"	60
71987	4 1/2"	7/8"	80
71988	7"	7/8"	40
71989	7"	7/8"	60
71990	7"	7/8"	80
71991	4"	5/8"	40
71992	4"	5/8"	60
71993	4"	5/8"	80

BENCH GRINDER WHEELS & ACCESSORIES

TYPE 1 BENCH GRINDER WHEELS

Vitrified bond, aluminum oxide. Designed for most stationary bench grinders. For general grinding and sharpening applications on mild steel. 1" Arbor hole with adapter reducer for 1/2", 5/8" & 3/4" arbors. Not for carbide applications.

Cat. #	Diameter	Thickness	Grit	R.P.M. max.
72392	5"	3/4"	36	4,966
72393	5"	3/4"	60	4,584
72394	5"	3/4"	80	4,584
82420	6"	1"	36	4,100
82421	6"	1"	60	4,100
82419	6"	1"	80	4,100
82422	6"	3/4"	36	4,100
82423	6"	3/4"	60	4,100
82431	6"	3/4"	80	4,100
82424	7"	1"	36	3,600
82425	7"	1"	60	3,600
82432	7"	1"	80	3,600
82426	8"	1"	36	2,865
72397	8"	1"	60	2,865
82433	8"	1"	80	2,865



72395• REDUCING BUSHINGS FOR 3/4" THICK WHEELS

72399• REDUCING BUSHINGS FOR 1" THICK WHEELS

Heavy duty plastic. Designed so that a 1" arbor grinding wheel will fit a 1/2", 5/8", or 3/4" shaft. Set of 3.



72390 GRINDING WHEEL DRESSER

Huntington type (#0), hooded cast iron. For dressing grinding wheels up to 10" diameter and 2" face. Overall length 10-1/2", weight 2 lbs.



72391• REPLACEMENT CUTTERS (SKIN-PACKED)

Made of carbon steel with long lasting, sharp teeth. Hardened to insure long service and proper dressing action. Set of 2 spacers & 4 cutters. 1-1/4" diameter, 1/4" hole, .426 face width. For use with above dresser.



Wear eye & face protection when using power tools

ABRASIVE SANDING DISCS



73148 Deluxe Universal Spanner wrench

Spanner wrench for grinders and sanding disc backing pads. Hardened steel. Fits most common sizes.

ABRASIVE SANDING DISCS

For edge sanding solder sanding or oil filling operations. "Shape Controlled" to resist the effect of humidity and of temperature. Aluminum Oxide mineral, heavy all-fibre backing. Close coat, resin bonded. Balanced to ensure high-speed performance.



Cat #	Diameter	Adapter Size	Grain
71749	4"	5/8"	16
71750	4"	5/8"	24
71751	4"	5/8"	36
71752	4"	5/8"	50
71753	4"	5/8"	80
71755	4"	5/8"	120
71736	4-1/2"	7/8"	16
71737	4-1/2"	7/8"	24
71738	4-1/2"	7/8"	36
71739	4-1/2"	7/8"	50
71740	4-1/2"	7/8"	80
71742	4-1/2"	7/8"	120
71757	5"	7/8"	16
71758	5"	7/8"	24
71759	5"	7/8"	36
71760	5"	7/8"	50
71761	5"	7/8"	80
71763	5"	7/8"	120
71765	7"	7/8"	16
71766	7"	7/8"	24
71767	7"	7/8"	36
71768	7"	7/8"	50
71769	7"	7/8"	80
71771	7"	7/8"	120

SANDING DISCS AND EMERY CLOTH

71720 OPENING INVENTORY EMERY CLOTH AND SAND SCREEN

Ideal for Polishing Machined Shafts and Roughing Plumbing Pipe Before Soldering or Gluing. Easy and Economical to Use. Tear off as needed and store. Contains one each of the following.

SAND SCREEN BENCH ROLL		
Silicon Carbide. Fast cutting. Long Lasting. Doesn't load up		
Cat.#	Size	Grit
71725	1-1/2" x 9'	80
71726	1-1/2" x 9'	120
71727	1-1/2" x 9'	180
71728	1-1/2" x 9'	320
EMERY CLOTH BENCH ROLL		
Aluminum Oxide		
Cat.#	Size	Grit
71803	1" x 10 yds	80
71804	1" x 10 yds	120
71805	1" x 10 yds	180
71806	1" x 10 yds	320



ABRASIVE CUTTING WHEELS

CUT-OFF WHEELS

Most popular sizes for metal and masonry are available in 1/8" or 3/32" thickness. Extra-heavy reinforcement for added safety at high speeds in all off-hand cutting applications. Made to meet or exceed all safety requirements. Please observe maximum RPM limits. Make sure material being cut is not allowed to twist and bind against the wheel. If a hand-held machine is used, keep it straight and do not twist the cut-off wheel.

Cat. #	Diameter	Thickness	Adapter Size	Max. RPM
METAL				
82336	7"	3/32"	7/8"	8, 600
82337	7"	3/32"	5/8"	8, 600
82338	8"	3/32"	5/8"	7, 500
82339	9"	3/32"	7/8"	6, 500
82340	8"	3/32"	1"	7, 500
72369	10"	3/32"	1"	6, 200
72370	12"	3/32"	1"	5, 100
82345	12	1/8"	20mm	6, 300
82349	12"	1/8"	1"	6, 300
82350	14"	1/8"	1"	5, 400
82355	14"	1/8"	20mm	5,400
72371	14"	3/32"	1"	4, 400
72372	16"	1/8"	1"	3, 800
CONCRETE & MASONRY				
72373	7"	1/8"	5/8"	8, 600
82448	8"	1/8"	5/8"	7, 500
72376	12"	1/8"	1"	5, 100
82344	12"	1/8"	20mm	6, 300
82347	14"	1/8"	20mm	5, 400
72377	14"	1/8"	1"	5, 400
ASPHALT				
82348	12"	5/32"	20mm	6, 300
82352	14"	5/32"	1"	5, 400



Special Price carton lots.

STEEL CUT-OFF WHEELS

Small diameter reinforced cut-off wheels for use on straight shaft and die grinders. Extra strength and safety for high-performance cutting and notching. Free cutting allowing the operator to work with a minimum of pressure for best control and lowest load on the tool.

Cat. #	Diameter	Thickness	Adapter Size	Max RPM
71922	3"	.035"	3/8"	25, 000
71780	3"	1/16"	1/4"	25, 000
71782	3"	1/16"	3/8"	25, 000
71784	3"	1/8"	1/4"	25, 000
71786	3"	1/8"	3/8"	25, 000
71813	3"	1/32"	3/8"	25, 000
71788	4"	1/16"	3/8"	25, 000
71790	4"	1/8"	3/8"	25, 000
71792	4"	1/16"	5/8"	19, 000
71794	4 1/2"	1/16"	7/8"	13, 200
71923	4 1/2"	.040"	7/8"	13, 200
71815	4"	1/32"	3/8"	25, 000
71924	5"	.040"	7/8"	12, 000
81886	7"	1/16"	5/8"	8, 500



WIRE BRUSH SAFETY INFORMATION AND USAGE RECOMMENDATIONS

IMPORTANT: All operators must read this information thoroughly and completely before using the brush!

Warning: In normal power brushing operations, the material that is being removed, such as burrs, scale, dirt, weld slag, or other residue, will fly off the brush with considerable force along with the brush filaments which break off due to fatigue.

The potential for serious injury exists for both the brush operator and others in the work area (possibly 50 or more feet from the brush). To protect against this hazard, before rotating the brush, during rotation, and until rotation stops, OPERATORS AND OTHERS IN THE AREA MUST WEAR SAFETY GOGGLES OR FULL FACE SHIELDS WORN OVER SAFETY GLASSES WITH SIDE SHIELDS, ALONG WITH PROTECTIVE CLOTHING.

You must follow all operator and safety instructions, as well as common safety practices, which will reduce the likelihood or severity of physical injury.

Summary-Power Brush Safety requirements

- Safety Goggles:** Safety goggles or full face shields worn over safety glasses with side shields MUST BE WORN BY ALL OPERATORS AND OTHERS IN THE AREA of power brush operations. Comply with the requirements of ANSI Z87.1-1979 "Occupational Eye and Face Protection."
- Guards:** Keep all machine guards in place.
- Speeds:** Observe all speed restrictions indicated on the brushes, containers, labels, or printed in pertinent literature. "MSFS" or "Max. SFS" means Maximum Safe Free Speed (R.P.M.)—spinning free with no work applied. For reasons of safety the "MSFS/Max. SFS" should not be exceeded under any circumstances.

4. Safety Standard: Comply with the Safety Standards of the Industrial Division of the American Brush Manufacturers Association and the American National Standards Institute Standard ANSI B165.1-1985 "Safety Requirements—Power Brushes" and ANSI B165.2-1982 "Safety Requirements—Power Brushes—Wood, Plastic, or Composition Hubs."

5. Protective Equipment: Appropriate protective clothing and equipment (such as gloves, respirator, etc.) must be used where a possibility of injury exists that can be prevented by such clothing or equipment.

6. Before Starting Brush: Use eye protection and safety equipment. Inspect brush for rust, damage, speed limit, etc. If no-load speed marked on the power tool is higher than the brush speed limit, do not mount brush. Inspect and jog machine to assure the brush is mounted properly and securely. Machine guards are in place, no vibration, etc. Run machine at operating speed for at least one minute before applying work—DO NOT STAND IN FRONT OR IN LINE WITH BRUSH.

WARNING

failure to observe safety precautions may result in INJURY

AVAILABILITY OF ANSI STANDARDS

On this slip reference is made to these ANSI Standards, ANSI B165.1-1985, ANSI B165.2, ANSI Z87.1-1979. Copies of these standards are available at Public Libraries and from American National Standards Institute, Inc. (ANSI), 1430 Broadway, New York, NY 10018, or American Brush Manufacturers Association, 1900 Arch Street, Philadelphia, PA 19103 (B165.1 and B165.2, only).

Many brush manufacturers mark some safety warnings, recommendations, and usage restrictions directly on the product. It is not always practical to include even the limited safety information on the brush itself. Therefore, THE OPERATOR MUST READ and FOL-

LOW ALL INSTRUCTIONS SUPPLIED IN OR ON THE PRODUCT CONTAINER AS WELL AS THOSE MARKED ON THE PRODUCT ITSELF. The operator should also refer to the safety and operation information printed in the brush manufacturer's catalog and other literature.

Pressure: Avoid excessive pressure when using a power brush. Excessive pressure causes over-bending of the filaments and heat build-up resulting in filament breakage, rapid dulling, and reduced brush life. Instead of greater pressure on a brush, it is suggested that you try: (1) a brush with a more aggressive cutting action (increased wire size, decreased filament length, change to a different brush type, i.e., knot type instead of crimped wire type), or (2) higher speed (increased R.P.M., increased brush diameter). **IMPORTANT NOTE: NEVER EXCEED the recommended MAXIMUM SAFE FREE SPEED R.P.M. (MSFS/Max. SFS) rating of the brush. See Fig. 1**

Figure 1: Pressure

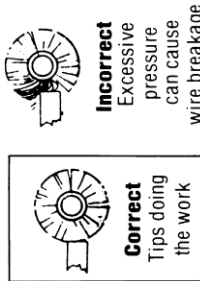

Self-Sharpening: When using wire wheel brushes, periodically reverse the direction of rotation to take advantage of the self-sharpening action that will result. This may be accomplished by removing the brush from the spindle and turning it side for side, and remounting securely. See Fig. 2.

Figure 2: Self-sharpening

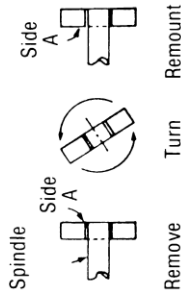

Brushing Problems: Do Not Allow Unsafe Conditions to Continue— Occasionally, due to worn bearings, a bent spindle, an unusual application, operator abuse, or inappropriate use, a brush may fail. A brush which is not received in acceptable condition for trouble-free operation may also fail. Do not use or continue to use a failed brush or one which is functioning improperly (i.e., throwing filaments, out-of-balance, etc.) as this increases the possibility for further brush failure and hazard of injury. The cause of the failure should be evaluated and corrected.

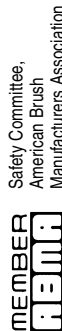

Safety Committee, American Brush Manufacturers Association

This information is based on the collective experience of the ABMA Industrial Division members and provided solely as a public service for the guidance of the users of the members products. These recommendations are not necessarily complete with respect to any particular application and common sense safety considerations should be adhered to generally. Any applicable federal, state, local law or regulation must be strictly adhered to, and is controlling over any recommendation contained herein.

GRINDING WHEEL SAFETY INFORMATION

- Be sure flanges are clean and straight.
- Be sure flanges are of same diameter.
- Be sure flanges are AT LEAST 1/3 the diameter of the wheel.
- Be sure flanges have proper clearance at arbor.

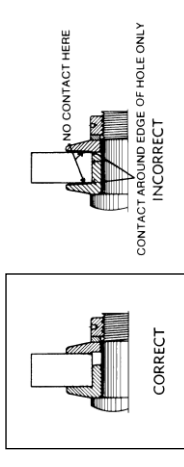

- If the wheel fits too loose on the arbor it can become badly out of true and will noticeably "pound." Arbor hole should be .006 to .010 inches larger than the arbor.
- Be sure there are good "blotters" between the wheel and the flanges.

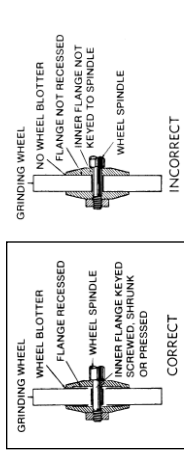

- Be sure the flanges are tightened securely but not too tightly—to avoid springing the flanges.

CUT-OFF WHEELS ARE EFFICIENT TOOLS IF PROPERLY OPERATED

MACHINE REQUIREMENTS

- MUST have adequate power.

Suggested Power Range for Cut-Off Machines

Diameter of Wheel	Wheel Speed D/C Ft. Per Min.	Wheel Speed Wet Cutting Ft. Per Min.	Minimum Suggested Power
10"	10,000-14,000	8,000-10,000	2 to 3 h.p.
12"	10,000-14,000	8,000-10,000	3 to 5 h.p.
14"	10,000-14,000	8,000-10,000	5 to 10 h.p.

- MUST maintain straight line cuts.
- MUST provide rigid support and "hold down" of piece being cut.
- MUST be avoided.
- MUST have proper drive flanges.

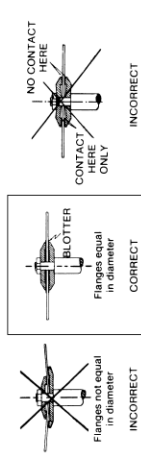

- MUST have adequate guard over the wheel.
 - MUST be maintained in first class condition.
- All machine features should be frequently checked and substandard conditions corrected to insure efficiency and safety.

BASIC ABRASIVE CUTTING PROCEDURE

- Be sure work piece is securely held down. (Both sides of the cut, if practical.)
- Start the cut gently—Do not "bump" the wheel to start a cut.
- Feed the wheel through the work as fast as possible without slowing the wheel in the cut. Don't "baby" the wheel through the cut.

A WORD OF CAUTION

Regarding types 27 & 28 (depressed centre) wheels. If used with nonstandard adapters, which have a deeper and smaller diameter offset, there is a danger of breaking out around the arbor hole. Be sure to use standard adapters with Type 27 and 28 wheels. See illustration for correct and incorrect assembly.

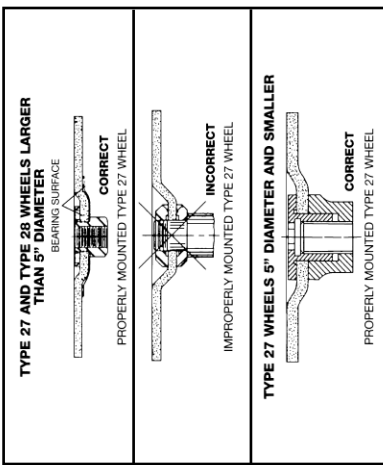

safety guide DO

- Always handle and store wheels in a careful manner.
- Always visually inspect all wheels before mounting for possible damage in transit. Vitrified wheels can be rung and should emit a clear bell-like tone if not cracked. Resinoid and rubber bonded wheels can only be checked visually.
- Always check maximum operating speed established for wheel against machine speed.
- WARNING: Don't use Grinding or Cut-Off Wheels on High Speed Air or Electric Sanders.**
- Always check mounting flanges for equal and correct diameter. (Should be at least 1/3 diameter of the wheel and relieved around hole.)
- Always use mounting blotters if supplied with wheels.
- Always be sure work rest for floor stand grinder is properly adjusted. (Centre of wheel or above; no more than 1/8" away from wheel.)**
- Always use a guard covering at least one-half of the grinding wheel.
- Always allow newly mounted wheels to run at operating speed, with guard in place, for at least one minute before grinding. When setting up automatic machines, make a test run with the wheel stopped.
- Always wear safety glasses and face protection when grinding.**
- Always turn off coolant before stopping wheel to avoid creating an out-of-balance condition.

safety guide DON'TS

- Don't use a wheel that has been dropped.
- Don't force a wheel onto the machine or alter the size of the arbor hole. Don't use a wheel that fits the arbor too loosely, if the wheel doesn't fit the machines, get one that does.
- Don't exceed maximum operating speed established for the wheel, which are not clean.
- Don't use mounting flanges which are warped, nicked, sprung, or don't lighten the mounting nut excessively. On multiple screw mountings, 15-foot pounds per screw is usually enough.
- Don't grind on the side of the wheel unless wheel is specifically designed for that purpose.
- Don't start the machine until the wheel guard is in place.
- Don't jam the work into the wheel.
- Don't stand directly in front of a grinding wheel when a grinder is started.**
- Don't grind material for which the wheel is not designed.



DIAMOND CUT-OFF BLADES

DIA-HARD DIAMOND CUT-OFF BLADES

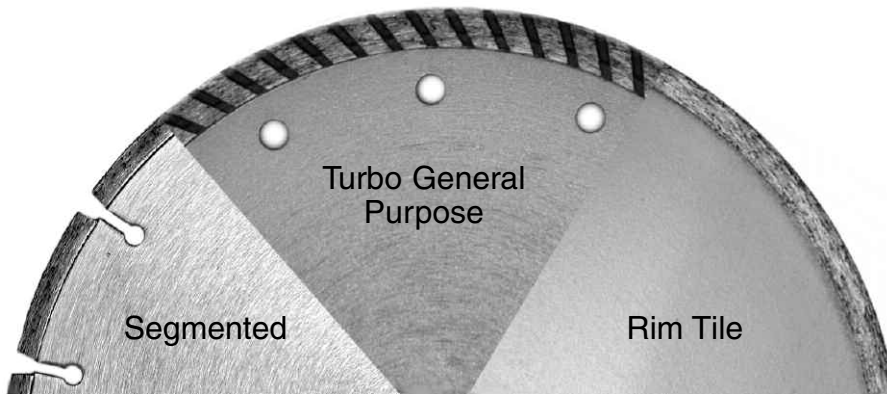
Premium Quality, German Engineered for Efficient Long Lasting Use. Includes Attractive Packaging and Comprehensive Labeling Designed to Highlight the Remarkable Cutting Abilities of These Fine Blades. Can be Used "Dry", but Recommend "Wet".



DIA-HARD DIAMOND CUT-OFF BLADES

	SIZE	TYPE	ARBOR WIDTH	CAT#
	4"	Rim Tile	5/8" or 20mm x 1/16"	71556
	4-1/2"	Rim Tile	7/8" or 5/8" x 1/16"	71557
	7"	Rim Tile	5/8" or 7/8-Diamond x 1/16"	71558
<i>(High Diamond Concentration for Cutting Tile Cleanly)</i>				
	4"	Turbo General Purpose	5/8" or 20 mm x 5/64"	71560
	4-1/2"	Turbo General Purpose	7/8" or 5/8" x 5/64"	71561
	7"	Turbo General Purpose	5/8" or 7/8-Diamond x 5/64"	71562
<i>(Fast Cutting Quality Blades for Brick, Block, Stone, Marble, Granite and other Building Materials)</i>				
	12"	Laser Segmented	1" or 20 mm x 3/32"	71566
	14"	Laser Segmented	1" or 20 mm x 5/32"	71568
<i>(Laser Welded Excellent Diamond Quality and Density for Large Tough Jobs: Cured Reinforced Concrete, Brick, Stone Block & other Building Materials. Please note: None of these are designed for use on "GREEN" concrete.)</i>				

Cutting "Depth" (Width of Diamond Embedded Segment):

71556 to 71562	3/16"
71566	1/4"
71568	5/16"

ABRASIVE CUTTING WHEELS

POLISHING BONNET

822545" Diameter	822507" Diameter
------------------------	------------------------



72040 6" BUFFING WHEEL

1/2" wide and 1/2" arbor. Maximum 3, 600 R.P.M.



82260 UNI-BONDED ABRASIVE DISC ASSORTMENT ALUMINUM OXIDE TRIM-KUT

3" Diameter Discs packaged in an attractive display carton which contains 2 of each disc plus the mandrels and adapters.
Items: 82262, 82263, 82264, 82265 and 82266.

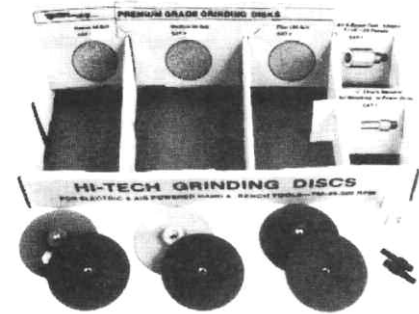

82266 TRIM-KUT ADAPTER

For use with angle grinders 7/16-20 NC thread.



82265 MANDREL FOR "TRIM-KUT" DISCS 1/4"



TRIMMABLE GRINDING DISCS NO BACKING PAD REQUIRED

"Trim-Kut" A super-fast cutting disc. Resistant to snagging, cracking. Long life. Superior stock removal. Grinds remarkably cool. Grind wood, metal, plastic, ceramics, composites, paint, rust, non-ferrous metals, glass, stone, fiberglass, welds, etc. Direct sparks down and away from body. Outlasts Resin Fiber discs 6 to 1. Use with electric drills and most grinders. No backing pad required - just spin on and go! Outer surface of disc normally becomes dull first. This may be trimmed. Operate grinder with the back surface of the disc inclined approximately 5 - 15° against a secured piece of scrap metal. Exert a slight amount of pressure toward the operator while operating at normal RPM. Store at room temperature and humidity. Avoid freezing.

Cat. #	Diameter	Grit	Maximum RPM
82262	3"	36	21, 000
82263	3"	60	22, 000
82264	3"	120	22, 000

ABRASIVE FLAP WHEELS

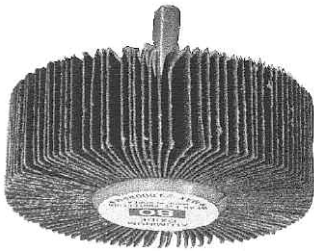

MOUNTED FLAP WHEELS

A convenient, effective abrasive system for removing unwanted material from around objects and hard to reach locations where rigid abrasives will not do the job. All flap wheels come with a 1/4" shank for use on drills and other chuck-mounted equipment. 3 grit ranges. 4 diameters.

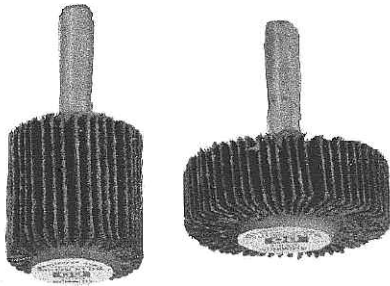

Cat. #	Carded #	Grit	Cat. #	Carded #	Grits
SIZE 2" x 1"			SIZE 3" x 1"		
71688	60184	60	71685	60181	60
71689	60185	80	71686	60182	80
71690	60186	120	71687	60183	120
SIZE 1" x 1"			SIZE 1 1/2" x 1/2"		
71694	60190	60	71691	60187	60
71695	60191	80	71692	60188	80
71696	60192	120	71693	60189	120

FLAP WHEELS



71681 DISPLAY TRAY

Contains one each of the items listed below.

71691	71692	71693
71694	71695	71696



71680 DISPLAY TRAY

Contains one each of the items listed below.

71685	71686	71687
71688	71689	71690

71682 DISPLAY TRAY

Contains one each of the 12 catalogue items listed separately on this page.

ABRASIVES AND POWER BRUSHES

72718 WIRE BRUSH OPENING DISPLAY KIT

Contains 36 Wire Brush items and includes a generic 12" x 24" Planogram and header cards
2 each of numbers: 10591 - 10592 - 10593 - 10594
Plus 36 hooks # 10231

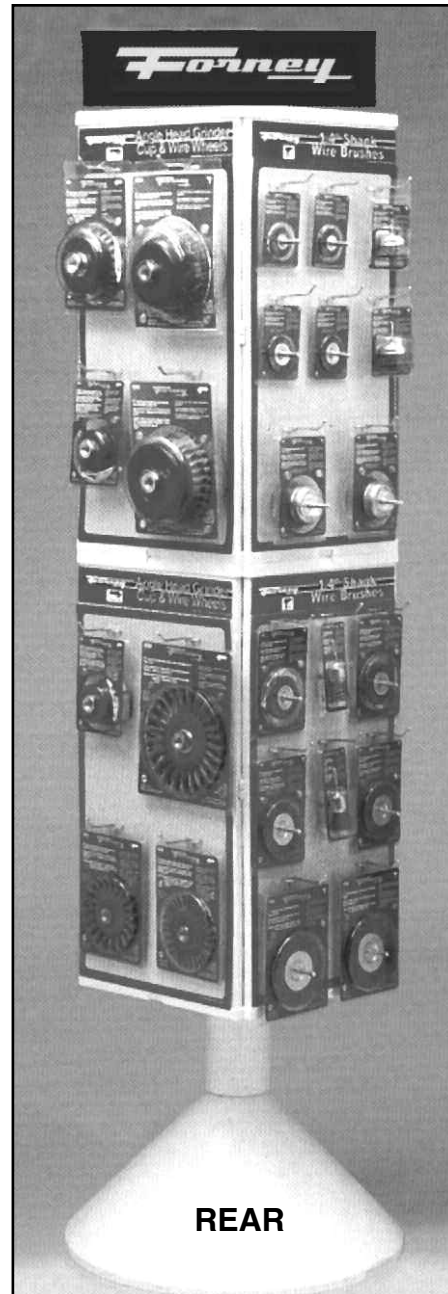
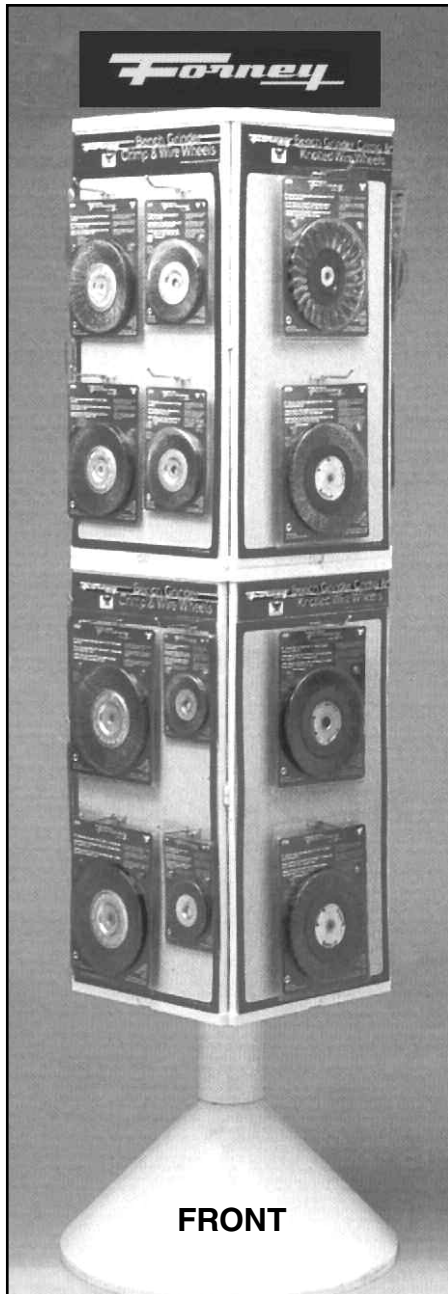

PACKAGED WIRE WHEELS & CUP BRUSHES

ABRASIVES AND POWER BRUSHES

FORNEY PACKAGED WIRE BRUSH CENTRE

1/4" Shaft Mounted Brushes and Bench Grinder Brushes for Home Shop Use. Bench Grinder and Angle Head Wire Brushes for Light Industrial Use. Packaged in Clam Shells with Point-of-Purchase Information, Bar Codes and Safety Instructions.

OPENING INVENTORIES AND PANEL DISPLAYS Cat# 72720 (Not Illustrated) METRIC DISPLAY

72721



PLAN-O-GRAM 1/4" shank
Wire Brush

72722



PLAN-O-GRAM
Bench Wheels
Red Cap

72723



PLAN-O-GRAM
Bench Wheels
Red Cap

72724



PLAN-O-GRAM
Angle Grinders

PACKAGED WIRE WHEELS & CUP BRUSHES

ABRASIVES AND POWER BRUSHES

NEW! PACKAGED WHEELS AND BRUSHES

Cat#	Description	RPM
1/4" SHANK WHEELS & BRUSHES		
72725	1-1/2" coarse crimp wire wheel	6,000
72726	1-1/2" fine crimp wire wheel	6,000
72727	2" coarse crimp wire wheel	6,000
72728	2" fine crimp wire wheel	6,000
72729	2" coarse crimp wire cup	6,000
72730	2" fine crimp wire cup	6,000
72731	3" coarse crimp wire cup	6,000
72732	3" fine crimp wire cup	6,000
72733	2-1/2" coarse crimp wire wheel	6,000
72734	2-1/2" fine crimp wire wheel	6,000
72735	3" coarse crimp wire wheel	6,000
72736	3" fine crimp wire wheel	6,000
72737	1" coarse crimp end brush	6,000
72738	1" fine crimp end brush	6,000
72739	4" coarse crimp wire wheel	6,000
72740	4" fine crimp wire wheel	6,000



72725



72731



72737



72733

OPEN ARBOR WHEELS BENCH GRINDING WHEELS

72741	5"x 1/2-5/8 arbor coarse crimp wire wheel	6,000
72742	4"x 1/2 arbor coarse crimp wire wheel	6,000
72743	5"x 1/2-5/8 arbor fine crimp wire wheel	6,000
72744	4"x 1/2 arbor fine crimp wire wheel	6,000
72745	6"x 1/2-5/8 arbor coarse crimp wire wheel	6,000
72746	3"x 1/2 arbor coarse crimp wire wheel	6,000
72747	6"x 1/2-5/8 arbor fine crimp wire wheel	6,000
72748	3"x 1/2 arbor fine crimp wire wheel	6,000
72749	6"x 1/2-5/8 arbor coarse knot wire wheel	6,000
72750	6"x 1/2-5/8 arbor coarse crimped wire wheel narrow face	6,000
72751	6"x 1/2-5/8 arbor fine wire wheel narrow face	6,000
72752	6"x 1/2-5/8 arbor coarse crimped wire wheel wide face	6,000



72742



72743



72751



72752

THREADED ARBOR WHEELS & BRUSHES FOR ANGLE-HEAD GRINDERS

72761	5"x 5/8 arbor coarse crimped wire wheel narrow face	6,000
72762	8"x 5/8 arbor coarse crimped wire wheel wide face	6,000
72753	4"x 5/8-11 thd knot wire cup brush	8,500
72754	5"x 5/8-11 thd crimp wire cup brush	8,500
72755	2-3/4"x 5/8-11 thd crimp wire cup brush	14,000
72756	6"x 5/8-11 thd knot wire cup brush	6,500
72757	2-3/4"x 5/8-11 thd knot wire cup brush	12,500
72758	6"x 5/8-11 thd knot wire wheel	9,000
72759	4"x 5/8-11 thd knot wire wheel	20,000
72760	4"x 5/8-11 thd stringer bead wire wheel	20,000
72780	2-3/4"x M-10x 1.25 crimped cup brush	14,000
72781	2-3/4"x M-10x 1.50 crimped cup brush	14,000
72782	2-3/4"x M-10x 1.25 knotted wire cup brush	12,500
72783	2-3/4"x M-10x 1.50 knotted wire cup brush	12,500
72784	4"x M-10x 1.25 knotted std. twisted wheel	20,000
72785	4"x M-10 x 1.5 TK wire wheel	20,000
72788	4"x 5/8-11 thd crimped wire wheel	15,000



72756



72780



72782



72785

ABRASIVES AND POWER BRUSHES

CUP BRUSHES & WIRE WHEELS

CRIMPED WIRE CUP BRUSHES



Cat. #	SIZE & THREAD	Max. RPM
72857	3" 1/2"-13NC	12, 500
72856	3" M14 x 2.0	12, 500
72856	3" 5/8"-11NC	12, 500
72855	3" M10 x 1.5	12, 000
72855	3" M10 x 1.25	12, 000
72887	4" 5/8"-11NC	6, 000
72860	5" 5/8"-11NC	6, 000

KNOT TWIST CUP BRUSHES

Cat. #	Size & Thread	Max. RPM
72865	3" M10 x 1.251	16, 000
72865	3" M10 x 1.5	16, 000
72866	3" 5/8"-11NC	16, 000
72866	3" M14 x 2.00	10, 000
72867	3" 1/2"-13NC	12, 500
72869	4" 5/8"-11NC	8, 500
72871	6" 5/8"-11NC	6, 000



BENCH GRINDER WIRE WHEELS

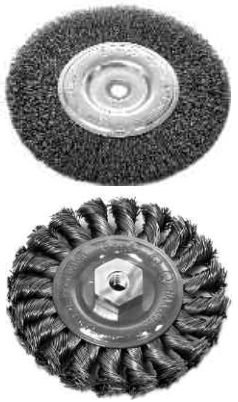

Cat. #	Diameter	Arbor	Style	Max. RPM
72841	6" x 5/8"	5/8"-11NC	knot twist	9, 000
72895	6" x 5/8"	1/2"	crimped	6, 000
72896	6" x 1"	1/2"	crimped	4, 000
72840	6" x 1"	1/2"	knot twist	9, 000
72897	8" x 1"	3/4" & 5/8"	crimped	4, 000

ADAPTERS FOR BENCH GRINDER WHEELS

72363	1/2"	72364	5/8"	72365	3/4"
72366	7/8"	72367	1"		



ABRASIVES AND POWER BRUSHES

CUP BRUSHES W/PROTECTIVE GUARD

- The guard acts as a shield that prevents wire, dust and any other kind of projection from reaching the user during work.
- The guard also makes the brush very user friendly in regards to handling the products.
- Powder Coated Hubs To Prevent Rusting.

CHECK IT OUT!!

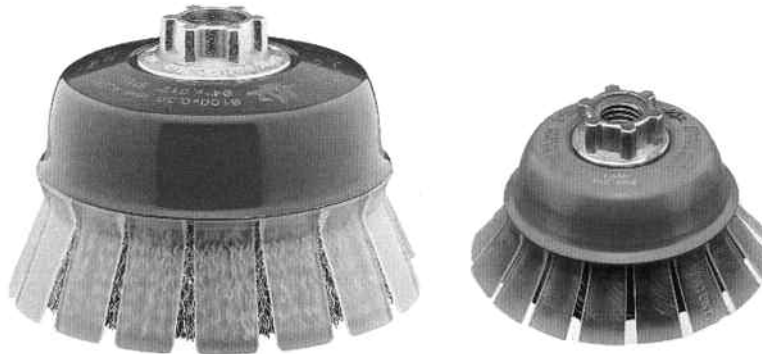

FORNEY	DESCRIPTION
72881	W/GUARD 3" Knot Cup M10x1.25/1.50 (CS)
72880	W/GUARD 3" Knot Cup 5/8"-11/M14 (CS)
72886	W/GUARD 3" Crimped Cup M10x1.25/1.50 (CS)
72885	W/GUARD 3" Crimped Cup 5/8"-11/M14 (CS)
72891	W/GUARD 3" Cable Crimped Cup M10x1.25/1.50 (CS)
72890	W/GUARD 3" Cable Crimped Cup 5/8"-11/M14 (CS)
72882	W/GUARD 4" Knot Cup 5/8"-11/M14 (CS)
72887	W/GUARD 4" Crimped Cup 5/8"-11/M14 (CS)
72892	W/GUARD 4" Cable Crimped Cup 5/8"-11/M14 (CS)

POWER BRUSHES

POWER BRUSHES



STRINGER BEAD BRUSH

Cat. #	SIZE & THREAD	Max. RPM
72845	4" M10 x 1.5	20,000
72847	4" 1/2 - 13 UNC	20,000
72845	4" X M10 x 1.25	20,000
72846	4" X 5/8 - 11 NC	20,000
72834	4" M10 x 1.5	20,000
72834	4" M10 x 1.25	18,000
72835	4" 5/8-11NC	20,000
72846	4" M14 x 2.0	18,000
72835	4" M14 x 2.0	20,000
72836	4" 1/2 - 13	20,000
72851	6" 5/8-11NC	9,000



72820

CIRCULAR WIRE BRUSHES

Ideal for use around the shop or home. 1/4" shank.
Use with electric hand drills.

Cat. #	Diameter	RPM
72821	3"	4,500
72822	3"	4,500
72818	1 1/2"	6,000
72819	2"	6,000
72820	2 1/2"	6,000



72257

72257 "TY-RADIAL" BRUSH

Special coating creates stiff aggressive cleaning action and extended brush life wire .014, RPM maximum 5,000. 3" diameter

PLEASE NOTE NEW CATALOGUE # ABOVE

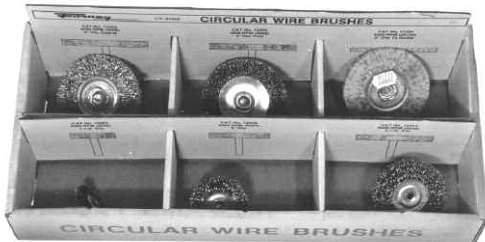

DISPLAY TRAY AND ASSORTMENT OF CIRCULAR WIRE BRUSHES

72246 contains 1 each
82247 contains a total of 30 items.

72818	72819	72820
72821	72822	

GRINDING WHEELS & BRUSHES



82275 WIRE CUP AND BRUSH DISPLAY

Ideal for the handyman or professional. Display tray contains 1 each of the following items.

72810	72811	72814
72827	72828	72829



72810



72811

CUP BRUSHES				
Cat #	Diameter	Arbre	Wire Size	Max. RPM
72827	1 1/2"	1/4"	.014	5,000
72828	2 1/2"	1/4"	.014	5,000
72829	2 1/2"	1/4"	.008	5,000
72857	3"	1/2"	13 x NC	13,000
72867	3"	1/2"	13 x NC	13,000
CRIMPED WIRE END BRUSH				
72810	3/4"	1/4"	.020	20,000
KNOT TWISTED END BRUSH				
72811	3/4"	1/4"	.020	20,000
CIRCULAR END BRUSH				
72814	1 1/2"	1/4"	.020	20,000

ALL PURPOSE 1/4" SHANK MOUNTED POINTS*

Quality aluminum oxide high speed mounted points for grinding, polishing and deburring.

82460 Display Tray of 12 Bulk Items (1 each)					
Carded	Bulk	Size	Carded	Bulk	Size
60025	72461	1" x 1 1/4"	60026	72462	1 1/4" x 1 1/4"
60027	72463	3/4" x 1 1/8"	60028	72464	7/8" x 2"
60029	72465	3/4" x 1 1/4"	60030	72466	1/4" x 3/4"
60031	72467	3/4" x 1"	60032	72468	1/4" x 3/4"
60033	72469	1" x 1"	60034	72470	1" x 1"
60035	72471	1" x 1 1/2"	60036	72472	1" x 1"



82457 DISPLAY TRAY ALL PURPOSE 1/4" SHANK MOUNTED GRINDING WHEELS

Rugged Dependable American Made Tools. 60 Grit Vitrified Aluminum Oxide. For Grinding Carbon, Alloy, and High Speed Steels as Well as Malleable and Wrought Iron, Bronzes & Other Hard Materials. For Use with 1/4" Drill. Especially Useful where Larger Wheels Won't Fit or Where Points Wear Too Quickly. Max. RPM 3,450 Contains 2 each of the following.



82451	1" x 1"	82452	1 1/2" x 1"
82453	2" x 1/4"	82454	2" x 1/2"
82455	2 1/2" x 1/4"	82456	2 1/2" x 1/2"

ABRASIVES AND POWER BRUSHES

ALL PURPOSE 1/4" SHANK ROTARY FILES AND WOOD RASPS*

Tough, Rugged Tools Made from Special Tempered Steel. Files have Specially Hardened, Durable Cutting Edges for Long Life. Can be Used on Steels, Bronze, Fiberglass, Plastic and Many Other Materials. Wood Rasps Remove Material in Hard to Reach Areas. Ideal for Power Drills to Shape and Smooth Wood. Available in Bulk or Skin-Pack. RPM: 2,500.

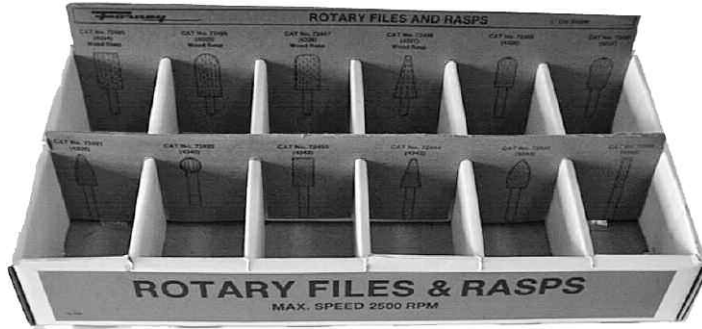

60024 SKIN-PACKED OPENING INVENTORY

Mounted Points, Rotary Files & Wood Rasps. Includes free Plan-O-Gram 10511 and hooks. 2,500 RPM

Carded	Bulk	Item	Carded	Bulk	Item
60065	72485	Rasp	60066	72486	Rasp
60067	72487	Rasp	60068	72488	Rasp
60069	72489	Rotary File	60070	72490	Rotary file
60071	72491	Rotary File	60072	72492	Rotary file
60073	72493	Rotary File	60074	72494	Rotary file
60075	72495	Rotary File	60076	72496	Rotary file

60119 Carbide Burs Opening Inventory (Carded)

Contains 1 each of the following items (14 items) plus a free Plan-O-Gram. 25,000 RPM

Regular		Mini	
60120	1/4" (SA-1)	60127	3/8" (SG-3)
60121	3/8" (SA-3)	60135	1/8" (SA-42)
60122	1/2" (SD-1)	60136	1/8" (SF-42)
60123	3/8" (SD-3)	60137	1/8" (SH-41)
60124	1/2" (SF-1)	60138	1/8" (SM-42)
60125	3/8" (SF-3)	60139	1/4" (SE-51)
60126	1/4" (SG-1)	60140	1/8" (SA-43)

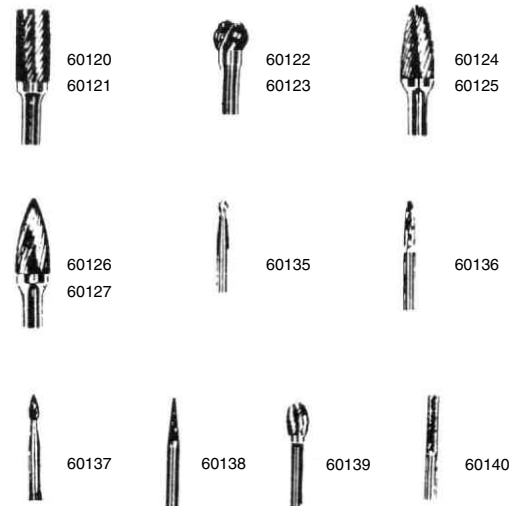

MICRO ABRASIVE CENTRE

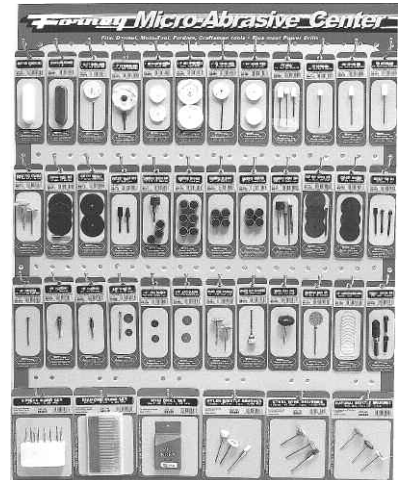

60200 OPENING INVENTORY (42 pc)

60197 OPENING INVENTORY (23 pc)

- High Speed Tools & Accessories; fit Dremel, Moto-Tool, Craftsman, Black & Decker, Wizard and Other Power Tools
- Attractively Skin-Packaged & Displayed on 24" x 30" User Friendly Plan-O-Gram
- Competitively priced for the Do-It-Yourselfer.

Cat.#	Description	Max Rpm	Cat.#	Description	Max Rpm
60201	1 oz. Red Jeweler's Rouge	30,000	60234	sanding discs set	30,000
60202	1 oz. White Buffing compound	30,000	60235	sanding discs 10-pcs.	30,000
60203	1" Buffing Wheel with Shaft	30,000	60236	Mini Pin Chuck set	30,000
60204	1-1/2" Cloth Buffing Wheel w/ shaft	30,000	60237	Burr set 8-pcs.	30,000
60205	1" Buffing wheel 2 pcs.	30,000	60238	Diamond Point set 20-pcs.	30,000
60206	1-1/2" Cloth Buffing Wheel 2-pc with shaft	30,000	60239	Mini Drill Bit set 20-pcs.	30,000
60207	1" Felt Polishing Wheel w/Shaft	30,000	60240	White nylon Impregnated Bristle Brush set 3-pcs.	15,000
60208	1" Felt Polishing Wheel 2-pcs.	30,000	60241	Wire Bristle Brush set 3-pcs.	15,000
60209	Felt Bob set-3 pcs.	30,000	60242	Bristle Brush set 3-pcs.	15,000
60210	Felt Bob, Ball	30,000	60243•	8 PC Grinding & Polishing Kit	30,000
60211	Felt Bob, Bullet	30,000	60244•	Sanding Sleeves 3/4" coarse 4 pc	30,000
60212	Felt Bob, Cylinder	30,000	60245•	Sanding Sleeves 3/4" medium 4 pc	30,000
60213	Brass Brush Set 2-pcs.	15,000	60246•	Sanding Sleeves 3/4" fine 4 pc	30,000
60214	Cut-Off Wheel set 4-pcs.	40,000	60247•	Sanding Drum 3/4"	30,000
60215	Cut-Off wheel 3-pcs.	40,000	60248•	Sanding Drum 3/4" Kit 5 pc	30,000
60216	Rotary Rasp set	30,000	60249•	Diamond Wheel 3/4" 4 pc	30,000
60217	Sanding drum 1/2" Kit	30,000	60250•	Diamond Wheel 3/4" 2 pc & Mandrel	30,000
60218	Sanding Sleeves 1/2" Fine 6-pcs.	30,000	60251•	Steel Wire Wheel 1" 2 pc	15,000
60219	Sanding Sleeves 1/2" Med. 6-pcs.	30,000	60252•	Satin Finish Buff Wheel 1" 2 pc	30,000
60220	Sanding Sleeves 1/2" Coarse 6-pcs.	30,000	60253•	Felt Wheel 3 row 3/32" Shank 7/8" 2 pc	30,000
60221	Mounted Point set 3-pcs. 1/2" x 1/2" Cylinder, 1/4" x 1/2" Ball, 1/8" Tree pt)	30,000	60254•	Rotary File Cutter 2 pc	30,000
60222	Cut-Off Wheel set w/Mandrel	30,000	60255•	Mini Burr- Flame 2 pc	30,000
60223	Cut-Off Wheels 3-pcs..	30,000	60256•	Mini Burr- Cone 2 pc	30,000
60224	Rotary File Cutter set 3-pcs. (cylinder, ball, flame)	30,000	60257•	Mini Burr- Inverted Cone 2 pc	30,000
60225	Mandrel 1/8" Shank x 1/16" Hole	30,000	60258•	Mini Burr- Wheel 2 pc	30,000
60226	Mandrel 1/8" Shank x Long screw	30,000	60259•	Mini Burr- Ball 2 pc	30,000
60227	Mandrel 1/8" Shank x Short screw	30,000	60260•	Chain saw Sharp Stone 5/32" 2 pc gray	30,000
60228	Saw Blade set (3-pcs.) 60225-60229-60330	30,000	60261•	Chain saw Sharp Stone 3/16" 2 pc brown	30,000
60229	Saw Blade Small 1/2" 2-pcs.	30,000	60262•	Chain saw Sharp Stone 7/32" 2 pc pink	30,000
60230	Saw Blade Large 5/8" 2-pcs.	30,000	60263•	Chain saw Sharpening Stone Set 3 pc	30,000
60231	Brass Circular Brush 2-pcs.	15,000	60264•	Mini Chuck Keyless	30,000
60232	Brass Cup Brush 2-pcs.	15,000	60265•	Micro Chuck	30,000
60233	Scuff-Buff pad with Mandrel	30,000			

SAFETY PRODUCTS



55663 SUPER SLIM ECONOMY HELMET

This light, durable, black nylon helmet features an extended lower bib which deflects spatter and improves rigidity. Comes with a 2" x 4 1/4" #10 shade and clear plastic cover lens. Complete with ratchet-adjustable headgear.

55671 ADJUSTABLE FLIP-FRONT HELMET - BLACK

This durable, tough, lightweight helmet (with an inner clear lens for protection) & extended lower bib to deflect spatter and improve rigidity is particularly useful for slag removal & grinding. Helmet comes complete with #10 shade lens & clear cover lens.



55685 ADJUSTABLE FLIP-FRONT (RED IN COLOR) HELMET WITH LARGE LENS

Lens has a large 4 1/2" x 5 1/4" viewing area. Comes complete with ratchet head gear.

55686 ADJUSTABLE FLIP-FRONT HELMET WITH LARGE LENS - BLACK

Lens has a large 4 1/2" x 5 1/4" viewing area. Comes complete with ratchet head gear.

55673 BLACK BANDIT II NYLON WELDING HELMET

Lightweight, this tough helmet has the added convenience of a large 4 1/2" x 5 1/4" viewing area. Complete with ratchet headgear 55674, #10 shade lens and clear protective cover lens.



55666 "THE BANDIT" BLACK PVC

This lightweight, tough durable welding helmet has a 2" x 4 1/4" lift front making it a good choice for the do-it-yourselfer. Helmet is complete with ratchet headgear 55674. Comes with a #10 shade lens.

55687
55801
55797
55807

Lift Front for 55686 4 1/2 x 5 1/4
Ratchet Headgear for 55671/55686
Headgear Repair Kit (55801)
Lens Retainer Spring 4 1/2 x 5 1/4

SAFETY PRODUCTS

AUTO-DARKENING WELDING HELMETS

FEATURES: Solar power cell design, no battery replacement required. Full automatic power ON/OFF. Can be used for MIG/MAG, TIG and ARC welding. Two switches to adjust the Delay Time and Sensitivity. Very light design, only 425g.

SPECIFICATIONS: Viewing Area: 98 mm x 44mm / 3.86" x 1.76"
 Cartridge Size: 110 mm x 90 mm / 4.33" x 3.54"
 Light State: Shade DIN4 - Dark State: Shade DIN 9-13
 Switching Time Light/Dark: 0.00004 sec.
 Helmet Material: High Impact Polyamide Nylon



1804A AUTO-DARKENING WELDING HELMET
 - Black



1855A AUTO-DARKENING WELDING HELMET
 - Black with flames



1858A AUTO-DARKENING WELDING HELMET
 - Green Camouflage



1859A AUTO-DARKENING WELDING HELMET
 - Red Spider web



1868A AUTO-DARKENING WELDING HELMET
 - Grey Spider web

9907	Front lens
9908	Inside lens
9909	Replacement auto-filter
9929	Replacement headband



9907



9908

SAFETY PRODUCTS



55676 PLASTIC HEADGEAR

For helmets 55791 and 55793. Has pin adjustment for crown strap & includes sweatband. Fits Jackson/Morsafe



55711 PLASTIC HEADGEAR

RATCHET ADJUSTMENT

Strong non-warping, self-extinguishing plastic features free floating suspension to eliminate pressure on head. Fits Fiber Metal helmets

55794 REPAIR ASSEMBLY

For the adjustments on helmet # 55711



55801 PLASTIC HEADGEAR

RATCHET ADJUSTMENT

Made with overhead crown straps, pivots attached to tabs extending from the headband connect the shell to the headgear, eliminating pressure to the wearer's temples.

Fits Forney helmets 55663, 55671, 55672 & 55686.



55667 Headgear with ratchet adjustment for 55666
Also Replaces 55689 Headgear.

SAFETY PRODUCTS

HELMET LENS - SIZE 4-1/2" X 5-1/4"



57029	Shade 5	57050	Shade 8
57051	Shade 9	57052	Shade 10
57053	Shade 11	57054	Shade 12
57055	Clear Plastic	57056	Clear Glass
57070	Gold Filter Shade 9		
57071	Gold Filter Shade 10		

WELDING GOGGLE LENSES

For cutting and gas welding operations. (Sold in pairs only)

56900	Shade # 5 - 50 mm Round
56901	Clear - 50 mm Round

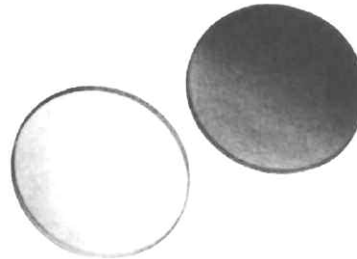

MAGNA WELD MAGNIFYING LENS

Can be used with most helmets and some goggles. May allow user to weld with or without glasses.

57101	Magna Lens F1.00	57103	Magna Lens F1.50
57105	Magna Lens F2.00	57107	Magna Lens F2.50

Darker shades are for intense welding at higher amperage or in sunlight. Lighter shades are for simple welding and indoors. Forney high quality clear plastic cover lenses offer superior protection from dust, weld spatter and impact.

The Lens Shade Selection Chart is a general guideline. Begin with a shade too dark to clearly see the weld zone. Then step down to a shade which clearly shows the weld zone. **Do not go below the chart recommendations. Use shade 5 lenses only for gas welding.** Don't take chances! Consult a physician if you are not certain about how to properly protect your eyes during a welding operation.

For prolonged periods of welding or to see true flame arc and puddle color we recommend our gold coated plastic lenses (see below).

In addition to full UV/IR protection, the gold coating reflects 90% of radiated heat for cooler operation and less eye fatigue. No Forney lenses are suitable for solar eclipse viewing.

* All Forney Lenses Meet or Exceed ANSI Z87.1 Specifications

Forney* Lens Shade Selection Chart

Lens Shade	Amps Arc Welding	Amps Mig Welding	Amps Plasma Cutting	Capacity Oxy-Acet.
5	-	-	-	1/2" Welding
8	15 to 20	-	5 to 20	8" Cutting
9	20 to 40	40 to 80	10 to 15	
10	40 to 80	80 to 150	15 to 30	
11	80 to 175	150 to 275	30 to 150	
12	175 to 300	275 to 450	150 to 250	



57005	Shade 5	57008	Shade 8
57009	Shade 9	57010	Shade 10
57011	Shade 11	57012	Shade 12
57060	Gold Filter Plate Plastic Shade 9	57061	Gold Filter Plate Shade 10
56800	Clear Plastic	56801	Clear Glass Lens



SAFETY PRODUCTS



55301 "CYCLOPS" WELDING GOGGLE

Soft one-piece opaque frames, with the lens holder as an integral part of the frame. Designed to follow the contour of the face and fit over prescription glasses. Elastic head band included. Takes a 2" x 4¼" lens



55304 SOFT VINYL FLIP-UP GOGGLES

Fit comfortably over regular eyeglasses. Cover lens fits in flip up. Shade #5 50 mm. lenses



55311 EYE CUP GOGGLES

Equipped with 50 mm round #5 shade lens and cover lens. Very compact when folded, excellent for pocket storage.



55320 LIFT-FRONT SOFT VINYL GOGGLES

Six air vents for cooling prevent fogging. Conforms comfortably to face. Allows ample room for eyeglasses. Cover lens fits under flip up. #5 Shade 2" x 4¼ lens

SAFETY PRODUCTS

55302 REPLACEMENT ELASTIC FOR GOGGLES

Ideal for replacing damaged or worn out head band on goggles. Top quality 1/2 elastic band.



55302

SAFETY GOGGLES

Forney offers goggles in both economy and deluxe models with clear and green lenses. Ideal for working in the shop. Great for some outdoor sports activities as well as yard chores such as trimming plants (WEED WACKERS ETC).



55305

55305 CHEMICAL GOGGLES

55310 CLEAR PLASTIC GOGGLES



55310

GRINDING SHIELD

Light weight for maximum comfort, made of tough poly-type plastic. Sturdy non-warp construction provides greater comfort, ventilation and safety. Two styles to choose from. Both take the same replacement shield.

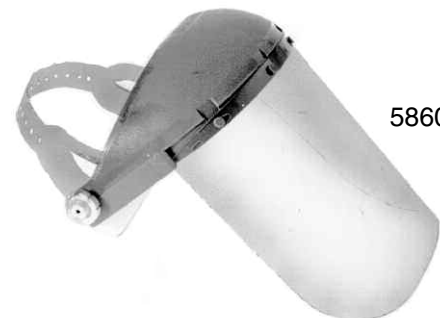

58600

58600 Complete grinding shield with clear lens

58601 Headgear only 58600

58602 Clear replacement lens for 58600

58603 Grey replacement lens for 58600

58606 Complete grinding shield with grey lens

58605 "Ratchet" grinding shield with clear lens

58606 "Ratchet" grinding shield with grey lens

58608 Ratchet headgear for 58605



58606

SAFETY PRODUCTS

**SAFETY GLASSES THAT ARE STYLISH, DURABLE,
LIGHT, FLEXIBLE FOR AN EASY FIT**



- 1 - 55283 Safety Glasses XL-22 -Clear Lens
- 2 - 55284 Safety Glasses XL-22 - #5 Shade
- 3 - 55285 Safety Glasses XL-22 -Gray Lens
- 4 - 55287 Safety Glasses Chroma - Clear Lens
- 5 - 55288 Safety Glasses Chroma - Mirrored Lens
- 6 - 55289 Safety Glasses - Gold Lens
- 7 - 55294 Visitor Glasses - Gray Lens
- 8 - 55295 Visitor Glasses - Clear Lens
- 9 - 55339 Hawk Safety Glasses (clear)
- 10 - 55340 Hawk Safety Glasses (mirrored)
- 11 - 55335 Fusion (Clear)
- 12 - 55336 Fusion (Mirrored)
- 13 - 55329 StarLite Amber/Yellow
- 14 - 55330 StarLite Mocha/Brown
- 15 - 55337 StarLite Clear
- 16 - 55338 StarLite Mirrored

Special Offer

With the Purchase of 20 Pairs of Safety Glasses Mix & Match You Will Receive a **Free 55299** Display Rack.



55299

55275 SAFETY GLASS PLAN-O-GRAM

Contains one each of the following - 55283, 55284, 55294, 55295, 55329, 55330, 55335, 55336, 55337, 55338, 55339, 55340

Plus 1 - 10515 POG and 12 - 10231 FREE

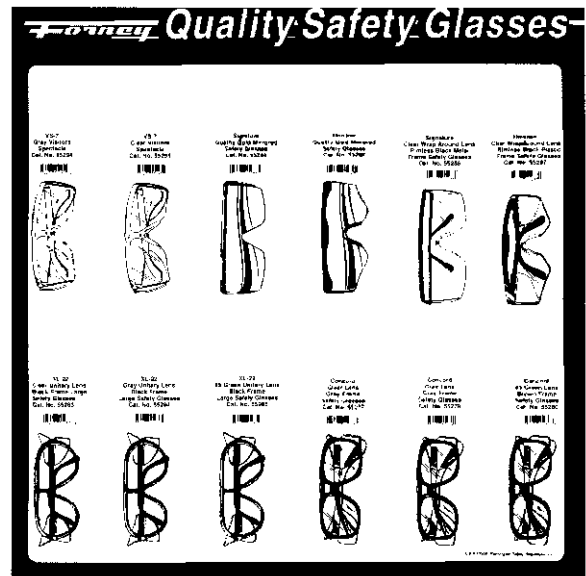

10515 PROTECTIVE EYE SAFETY GLASSES

SAFETY GLASSES

SAFETY PRODUCTS

55905 MULTI-PURPOSE RESPIRATOR

General Purpose. Protects against Dust, Paints including Enamel, Lacquers, Pesticides and Organic Vapors. For Homemakers, Gardeners, Painters, Auto Body Workers.



55905

55910 COMPLETE ORGANIC VAPOR REPLACEMENT CARTRIDGE FOR 55905 (PAIR)

55915 PRE-FILTER FOR 55905

(6 pack with 2 retainers)



55910



55915

55975 DISPOSABLE RESPIRATORS (2 per package) FOR DUSTS & MISTS (OSHA APPROVED)

For General Use. Protection against Paints, Sprays, Dust, etc.



55975

DUST MASKS

55973 50 per package

A Double Absorbent Filter with Comfortable Custom Nose Piece. Ideal for Sawing, Sanding & Shaping Wood and for other Dusty Work Areas. For Paint & Other Fumes-see 55975 or, especially, 55905 above.

55871 - 5 per package

55876 - 6 packages of 50

55877 - 12 packages of 50

55878 - Dust & mist respirator box of 20

55879 - Dust & mist respirator package of 5

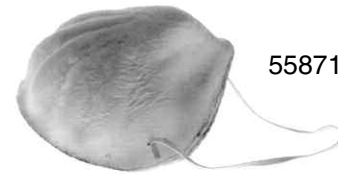

55871

55980 TRU-FIT HEARING PROTECTION (YELLOW)

Lightweight Earmuff. Provides excellent ear protection and comfort. Designed for common levels of industrial noise Ear Cups Adjustable. N.R.R. Overhead 21.*

55984 DELUXE TRUE-FIT HEARING PROTECTION (RED)

Ear Muffs provide maximum protection from most noise. Quick, easy removal for brief communication in very loud conditions. Headband adjustable and padded for added comfort. N.R.R. Overhead 22.*



55993 (6 PR) SAFE-EAR SOFT FOAM INSERTS

Easily compressed, they hold a thin shape until inserted. Then they expand to give excellent sound protection. Disposable. N.R.R. 25 dba.*



55993

RESPIRATORS & DUST MASKS

GLOVES

55193 DEERSKIN TIG WELDER'S GLOVE
Men's X-Large

Tig welder's glove, deersplit, stiff split cuff.

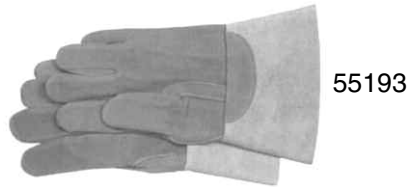

55194 SHEEPSKIN TIG WELDER'S GLOVE
Men's X-Large

Tig welder's glove, sheepskin, stiff cow split cuff.

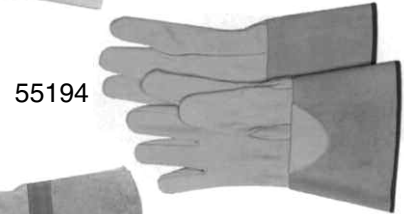

55196 PREMIUM WELDER'S GLOVE
Men's Small – Medium

55197 PREMIUM WELDER'S GLOVE
Men's Large – X-Large

Welders gauntlet, Kevlar™ stitched throughout, welted last finger, fully lined fleece hand, rivet at inside cuff.



55198 UNLINED WELDER'S GLOVE

Cowhide palm, cowsplit back, 4" cuff.



55202 LEATHER WELDING MITTS

Ideal for working in a cold environment.



55200 LINED LEATHER WELDING GLOVES
Men's Large

Lined interior for insulation against heat. Heavy-duty, long lasting for maximum protection. 13-1/2" long.



55199 UNLINED LEATHER WELDING GLOVES
Men's Large

Heavy-duty. Heat resistant. Protects against sparks, hot slag & hot metal. Canvas gauntlet gives added strength and protection. 12-1/2" long.



55203 DELUXE LINED ALL LEATHER WELDING GLOVES

Men's Large

Top of the line. Fully lined interior for additional insulation against heat. Excellent protection, comfort and durability. 13-1/2" long.

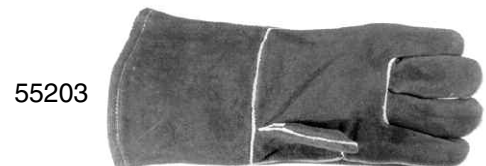

55259 GAUNTLET PVC COATED GLOVES
Men's Large

For Use with Liquids. Resist Snags & Cutting.



BULK AIR FITTINGS

NEW! BULK AIR FITTINGS BY FORNEY

**Bulk Plugs and Couplers in Tilt Out Bins
Catalog #75210**

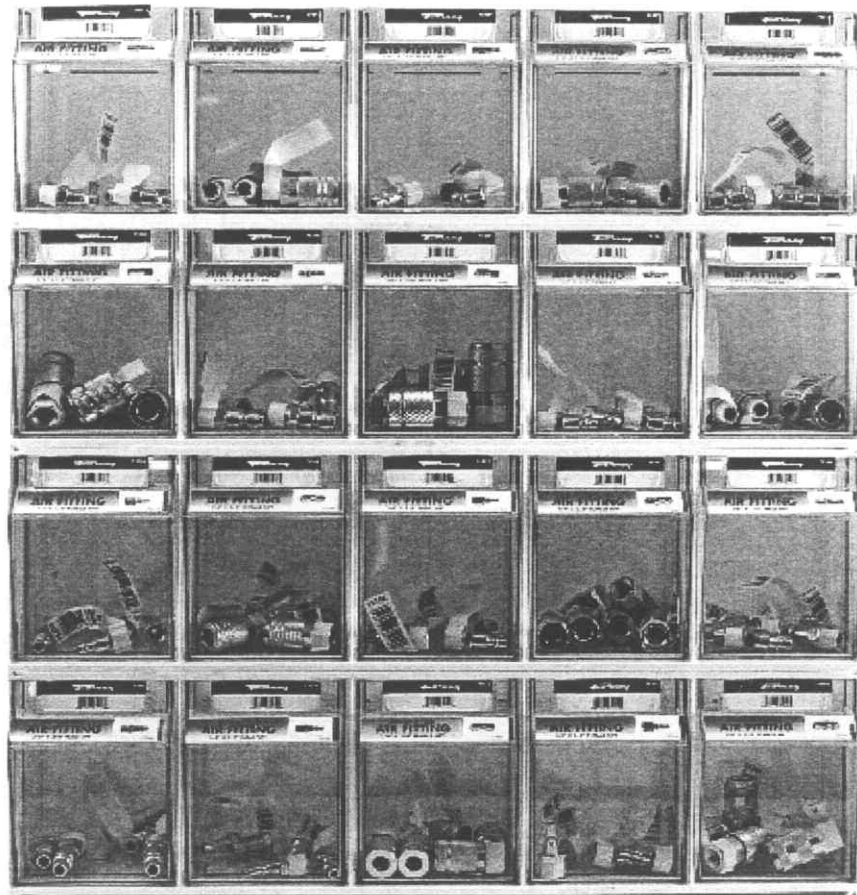

**HORIZONTAL 5 COMPARTMENT
BIN TRAY ONLY
Cat. No. # 10254**

BULK AIR FITTINGS



HEAD OFFICE: Regina, Saskatchewan • Telephone: 1-800-667-8161 Fax: 1-800-404-3551
EASTERN WAREHOUSE: Hawkesbury Ontario • Telephone: 1-888-811-0889 Fax: 1-888-811-1120

BULK AIR FITTINGS

T-Style Tru-Flate/Parker Interchange Series – 1/4" Basic Size

Part No.	Description
75215	1/4" male NPT plug
75220	1/4" female NPT plug
75222	1/4" male NPT coupler



75215



75222



75220

P-Style Tru-Flate/Parker Interchange Series – 3/8" Basic Size

Part No.	Description
75224	1/4" male NPT plug
75226	3/8" female NPT coupler
75228	3/8" male NPT plug
75230	1/4" female NPT coupler



75224



75226



75228



75230

M-Style Industrial Interchange Series – 1/4" Basic Size

Part No.	Description
75234	1/4" male NPT plug
75236	1/4" male NPT coupler
75238	1/4" female NPT plug
75240	1/4" female NPT coupler
75242	3/8" male NPT plug
75244	3/8" female NPT coupler



75234



75236



75238



75240



75242



75244

H-Style Industrial Interchange Series – 3/8" Basic Size

Part No.	Description
75246	1/4" male NPT plug
75247	3/8" female NPT coupler
75248	3/8" male NPT plug



75246



75248



75247

A-Style Aro "210" Style Series – 1/4" Basic Size

Part No.	Description
75250	1/4" male NPT plug
75252	1/4" female NPT coupler
75254	1/4" female NPT plug



75250



75252



75254

AMT Style 3-Way Coupler – 1/4" Basic Size

Part No.	Description
75260	1/4" female NPT coupler



75260

PACKAGED AIR FITTINGS & ACCESSORIES

COUPLERS / PLUGS...

...provide compressed air for tools/accessories in homes and shops. The quick disconnect coupler and matching nipple system provides smooth, fast interchanging of tools from the same air source, extending the length of an air system.

TRU-FLATE DESIGN

(Color Code: Yellow)

Tru-Flate Plugs have an extremely short pilot—the widest metal section between the ball groove and the pilot. This and wider sealing surfaces on the end of the plug results in tighter sealing and longer life. True-Flate Couplers allow more air flow at pressure drops. The protective collar also guards against accidental disconnect.



75519• COUPLER/PLUG SET

1/4" Female NPT Coupler

1/4" Male NPT Plug

1/4" PLUGS

1/4" COUPLERS

75590 1/4" NPT Male



75309• 1/4" NPT Male



75308 1/4" NPT Female



75315• 1/4" NPT Female



75470• 1/4" Male



75478• 1/4" NPT Female



75398 1/4" x 3/8" NPT Female



75400• 1/4" x 1/4" ID Hose Barb



75399 1/4" x 3/8" NPT Male



75401• 1/4" x 3/8" Female NPT



75402• 1/4" x 3/8" Male NPT



3/8" PLUGS

3/8" COUPLERS

75475• 1/4" NPT Male



75320• 3/8" NPT Female



75306• 3/8" NPT Male



75484• 3/8" NPT Male



75476• 3/8" NPT Female



75485• 1/4" NPT Female



75322 3/8" x 1/4" NPT Female



PACKAGED AIR FITTINGS & ACCESSORIES

INDUSTRIAL/MILTON DESIGN

(Color Code: Red)

The 3/16" pilot and flat "V"-shaped ball groove plug design is considered the standard because it has been adapted by most coupler manufacturers. Couplers are available in standard and push-to-connect style sleeves. Push-to-connect styles are for permanent wall mounted connections.



75305• COUPLER/PLUG SET

1/4" Female NPT Coupler
1/4" Male NPT Plug

1/4" PLUGS

75600
NPT Male



75602
NPT Female



75471
NPT Male



75472
NPT Male



1/4" COUPLERS

75316
NPT Male



75317
NPT Female



75479
NPT Female



75480
1/4" x 1/4" Hose Barb



1/4" PUSH-TO-CONNECT STYLE SPRING CLIP TYPE LOCK MECHANISM

For wall mounted connections

75520•
1/4" Female NPT

75521•
1/4" Male NPT



3/8" PLUGS

75307
NPT Male



75474
NPT Female



75323
1/4" NPT x 3/8" Male



3/8" COUPLER

75483
NPT Male



75321
NPT Female



75324
3/8" x 1/4" Female NPT



PACKAGED AIR FITTINGS & ACCESSORIES

Aro is easily identified by a 5/16" pilot and nearly round ball groove. Couplers are available in standard and push-to-connect style sleeves.

ARO DESIGN (Color Code: Green)



75522• COUPLER/PLUG SET
1/4" Female NPT Coupler 1/4"
Male NPT Plug

1/4" PLUGS

1/4" COUPLERS

75303 1/4" NPT Male



75482 1/4" NPT Male

75473 1/4" NPT Female



75318 1/4" NPT Female

LINCOLN DESIGN (Color Code: Blue)



75523• COUPLER/PLUG SET
1/4" Female NPT Coupler 1/4"
Male NPT Plug

1/4" PLUGS

1/4" COUPLERS

75304 1/4" NPT Male



75525 1/4" NPT Male

75524 1/4" NPT
Female

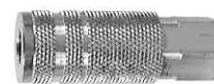

75319 1/4" NPT Female

High Quality Universal Couplers fit the three most popular air line plugs. Can be used with True-Flate, Industrial Milton & Aro Design 1/4" Plugs. Push-to-connect style makes coupling quick & easy.

UNIVERSAL DESIGN (Color Code: Gold, Red & Green)



75526
1/4" COUPLER NPT Male

75527
1/4" COUPLER NPT Female

PACKAGED AIR FITTINGS & ACCESSORIES



AIR HOSE SPLICERS

75355•.....5/16" Hose Mender
75357•.....3/8" x 3/8" Hose Barb
75361•.....1/4" x 1/4" Hose Barb
Used to repair damaged hose or to extend sections for greater length.



FEMALE HOSE ENDS

75362•.....1/4" NPT x 1/4" Hose Barb
75358•.....1/4" NPT x 3/8" Hose Barb



MALE HOSE ENDS

75353•..... 5/16" ID Male Hose End 1/4" NPT
75354•..... Male Hose End 3/8" ID x 3/8" NPT
75360•.....1/4" NPT x 1/4" Hose Barb
75359•.....1/4" NPT x 3/8" Hose Barb

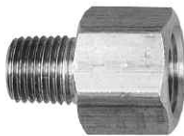

75447 REDUCER ADAPTER

3/8" NPT Female à 1/4" NPT Male



75448 BRASS COUPLING

1/4" NPT Male x 1/4" NPT Male (non-swivel style)



75385 COUPLER TEST BAR

Tru-Flate, Industrial/Milton, Aro and Lincoln

Quickly and Accurately Identify the Proper 1/4" series Plug for a Coupler. Metal Bar has Each of Four Basic Design Plugs. Each Design Name is Stamped on Bar.

PACKAGED AIR FITTINGS & ACCESSORIES

75530• FEMALE HOSE END*

3/8" Hose Barb x 3/8" Female NPT



75530



75531

75531• FEMALE SWIVEL HOSE END*

1/4" Hose Barb x 1/4" Female NPT

75532• BRASS FEMALE COUPLING

1/4" Female NPT x 1/4" Female NPT



75532



75533

75533• BRASS REDUCER

3/8" Male NPT x 1/4" Male NPT

75534• BRASS BUSHING 1/8"

1/4" Female NPT x Male NPT



75534



75535

75535• BRASS BUSHING

1/4" Female NPT x 3/8" Male NPT

75536• BRASS BUSHING

3/8" Female NPT x 1/2" Male NPT



75536



75537

75537• BRASS BALL END ADAPTER

1/4" Male x 1/4" Male NPT

AIRLINE SWIVEL FITTINGS

Eliminates Kinked & Twisted Airline Hose by Swiveling a Full 360 degrees. Use on Air Lines, Tools and Compressor Connections for Increased Flexibility and Convenience.

75538• 1/4" AIRLINE SWIVEL* BARB TYPE

1/4" Male NPT x 1/4" Hose Barb. Connect to Hose with a Clamp or Crimp on Ferrule.



75538

75539• 3/8" AIRLINE SWIVEL* BARB TYPE

1/4" Male NPT x 3/8" Hose Barb. Connect to Hose with a Clamp or Crimp on Ferrule.



75539

75540• AIRLINE SWIVEL

1/4" Female NPT x 1/4" Male NPT. Perfect for Compressor to Airline Connection.



75540

BRASS BUSHINGS & HOSE ENDS

AIR FITTINGS AND ACCESSORIES

BLOW GUNS



75330



75331



75332



75334

75333



75494



75529

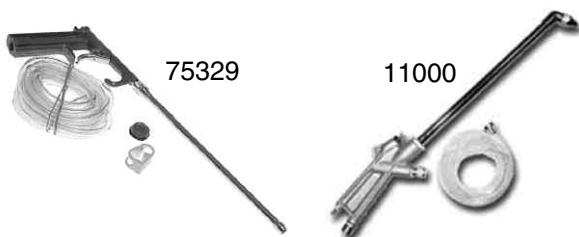

75329

11000

BLOW GUNS

NOTE: All Forney Blow Guns conform to OSHA standards, including noise level and output pressure with an inlet pressure of 150 psi. All constructed from heavy die casting & are 1/4" female NPT. Always wear safety glasses to avoid eye damage.

75330• SYPHON SPRAY & BLOW GUN COMBO

Has barbed inlet that fits 1/4" ID hose. Spray liquids to clean parts, apply protective coatings or to clean engines. (Must be used on regulated 30 psi airline).

75331• SAFETY BLOW GUN

Pressure reduction to 30 psi. Vented nozzle relieves pressure if nozzle should become plugged or obstructed.

75332• SAFETY BLOW GUN

Small lightweight unit with vented nozzle.

75333 ADJUSTABLE POCKET BLOW GUN

75334 ADJUSTABLE POCKET BLOW GUN

Adjustable Pocket Blow Guns. Quick turn adjusts from low to full volume air flow. Great for Home or Shop use. Handy Pocket Clip. Must be used on regulated 30 psi airline. Maximum recommended pressure 150 PSI.

INDUSTRIAL/MILTON DESIGN 1/4" Plug

75494 BLOW GUN WITH RUBBER TIP

For blowing out tubing lines & small orifices. Excellent for cleaning carburetors, etc. (Replacement tips available.)

75529 DELUXE BLOW GUN KIT

All purpose blow gun with attachments for blowing sawdust, grass clippings, drying surfaces or inflating balls, and air mattresses.

11000 ENGINE CLEANING GUN

Clean motors, farm equipment, poultry houses, shop machinery, floors, walls, tiles, etc.. Operating pressure range is 40 to 150 PSI. Solvent is drawn from the container and mixed with the compressed air. Dissolves stubborn dirt, grease, mud, etc. Weight - 1/2 pound.

75329 PISTOL GRIP SPRAY CLEANING GUN

AIR FITTINGS AND ACCESSORIES



11049



11050

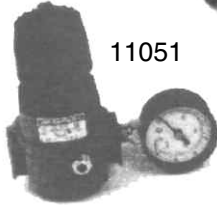

11051

11049 AIR FILTER 5 Micron Filter with 1/4" NPT.

11050 PRECISION LUBRICATOR 1/4" NPT
2 oz. bowl with guard. 150 PSI Maximum Working Pressure

11051 REGULATOR AND GAUGE
Regulated pressure range is from 0 to 125 PSI
1/4" NPT standard female fittings.
Maximum working pressure of 150 PSI.

PRESSURE GAUGE

75565	1/8" NPT, 160 PSI	11028	1/4" NPT, 100 PSI
11027	1/4" NPT, 160 PSI	11029	1/4" NPT, 200 PSI
75554	1/4" NPT, 160 PSI		



75554



11018

75548 1/4" BRASS CHECK VALVE

For air compressors.



75549

11018 3/8" BRASS CHECK VALVE

For air compressors.

75549• TANK MANIFOLD FOR AIR COMPRESSORS

TANK MOUNT 1/2" NPT SWITCH MOUNT 1/4" NPT GAUGE & OUTLET 1/4" NPT. Allows the user to attach a manifold to the tank, a pressure switch and a safety valve to the manifold, plus a port for a pressure gauge.



75550

75550• TANK MANIFOLD FOR CARRY TANKS

TANK MOUNT 1/2" NPT/GAUGE & NPT OUTLETS 1/4" NPT
Same as 75549 above without the pressure switch outlet.



75551

BRASS SAFETY VALVES (POP OFF TYPE)

75551 •1/4" NPT 150 PSI

75552 •1/4" NPT 125 PSI



11047

11047 SAFETY VALVE

Set at 140 PSI, 1/4" NPT Non Adjustable.



75365
75366



75363
75364

75363• BRASS TEE1/4" NPT 150 PSI

75364• BRASS TEE3/8" NPT 150 PSI

BRASS CROSS (4-WAY)

75365•1/4" NPT 150 PSI

75366•3/8" NPT 125 PSI

AIR FITTINGS AND ACCESSORIES

1/4" Series Couplers

All LIKE DESIGN 1/4" series nipples shown here WILL MATE all 1/4" series nipples to the left.

1/4" Series Nipples

All LIKE DESIGN 1/4" series couplers shown here WILL MATE all 1/4" series couplers to the right.

FORNEY CAT #	TRUE- FLATE	ACME	APS	AMELO	ARO	BALKAMP	CAMEL	CHAMP	LINCOLN	MILTON	PARKER	SCHRADER	TRW	TRUE- FLATE	IND/MILTON DESIGN
75470	12-104	—	—	CP12	—	90-636	61-544	—	—	779	—	3508	—	12-104	13-164
75300	12-117	—	9-671	CP1-42	—	90-628	61-540	—	—	—	8C	—	—	12-117	13-101
75308	12-120	—	9-661	CP1-01	—	90-632	61-542	—	—	—	2C	3506-D	—	12-120	13-125
75308	12-125	—	A928NBL	CP1	—	—	61-538	9-659	670085	S-783	3C	3507-D	—	12-125	13-135
75308	12-135	—	A929NSBL	CP2	—	—	61-539	9-660	670085	S-784	—	—	—	12-135	13-136
75301	12-225	—	9-706	CP21	—	—	61-578	9-654	670038	S-727	H2C	5138-11D	—	12-225	13-201
75471	12-226	—	9-707	CP21-03	—	—	61-535	—	—	—	H2CE	5138-11	—	12-226	13-225
75302	12-235	—	9-683	CP20-23	—	—	61-579	—	—	—	H3C	5139-11D	—	12-235	13-226
75472	12-264	—	9-604	CP20-23	—	—	—	—	—	—	H2CE	—	—	12-264	13-235
75472	12-264	—	9-604	CP21-42	—	—	61-576	—	—	—	H3C	5223-11	—	12-264	13-236
75472	12-266	—	9-603	CP21-44	—	—	—	—	—	—	H3C	—	—	12-266	13-264
75303	12-324	—	9-683	CP37	—	—	61-528	—	—	—	A3C	3529	—	12-324	13-301
75303	12-325	—	A914NBL	CP37	—	—	61-528	—	—	—	A3C	3529-D	—	12-325	13-301
75473	12-334	—	A918NBL	CP38	—	—	61-529	—	—	—	A3C	3530	—	12-334	13-324
75473	12-335	—	A918NSBL	CP38	—	—	61-529	—	—	—	A3C	3530-D	—	12-335	13-334
75473	12-424	—	A933NBL	CP27	—	—	61-550	—	—	—	L2C	3531	—	12-424	13-374
75304	12-425	—	A933NSBL	CP27	—	—	61-550	—	—	—	L3C	3532	—	12-425	13-375
75304	12-424	—	A934NBL	CP28	—	—	61-551	—	—	—	L2C	3532-D	—	12-424	13-424
75324	12-425	—	A934NSBL	CP28	—	—	61-551	—	—	—	L3C	3532-D	—	12-425	13-425

3/8" Series Couplers

All LIKE DESIGN 3/8" series couplers shown here WILL MATE all 3/8" series nipples to the left.

3/8" Series Nipples

All LIKE DESIGN 3/8" series nipples shown here WILL MATE all 3/8" series couplers to the right.

FORNEY CAT #	TRUE- FLATE	ACME	APS	AMELO	ARO	BALKAMP	CAMEL	CHAMP	LINCOLN	MILTON	PARKER	SCHRADER	TRW	TRUE- FLATE	IND/MILTON DESIGN
75307	12-526	—	9-717	CP25	—	—	61-484	—	—	—	H2E	3542	—	12-526	13-526
75474	12-527	—	9-717	CP25	—	—	61-484	—	—	—	H2E	3542	—	12-527	13-527
75474	12-537	—	9-605	CP26	—	—	61-485	—	—	—	H3E	3543	—	12-537	13-537
75398	12-526	—	—	—	—	—	—	—	—	—	—	—	—	12-526	13-526
75399	12-529	—	—	—	—	—	—	—	—	—	—	—	—	12-529	13-529
75475	12-603	—	A944NBL	CP7	—	—	61-480	9-672	670059	S-1809	OE	3519	—	12-603	13-603
75306	12-604	—	A944NSBL	CP5	—	—	61-480	9-672	670059	S-1809	OE	3519-D	—	12-604	13-604
75306	12-604	—	A944NSBL	CP5	—	—	61-480	9-672	670059	S-1809	2E	3517	—	12-604	13-604
75476	12-610	—	A945NBL	CP8	—	—	61-481	9-674	670060	S-1807	3E	3520	—	12-610	13-610
75476	12-612	—	A945NSBL	CP6	—	—	61-481	9-674	670061	S-1808	3E	3518	—	12-612	13-612



AIR FITTINGS AND ACCESSORIES



75555
75556

PRESSURE SWITCH

Automatically maintains tank pressure on small compressors.

75555	80 -100 PSI	75556	95 - 125 PSI
-------	-------------	-------	--------------



75558



75561

11042 BLEEDER VALVE

75558 3-in-1 MANIFOLD

(3) 1/4" NPT OUTLETS & (1) 1/4" NPT INLET

To supply three air tools with one source. Air hose end or fixed bench outlet. The perfect shop bench accessory.



75560



75562

BRASS MANIFOLDS

75560• 3-IN-ONE MANIFOLD (FLAT) 1/4" NPT 125 PSI

75561• SWIVEL 1/4" MALE NPT x 1/4" FEMALE NPT 125 PSI

75562• UNIVERSAL SWIVEL 1/4" MALE NPT x 1/4" FEMALE NPT 125 PSI



A



B

75541 AIR HOSE REPAIR KIT

For Repairing 1/4" I.D. Hoses.

Includes items A, B, C, D.



C



D



75542

75542 AIR/WATER ADAPTER

For filling Tires with liquids. Connects standard tractor valve to 3/4" Garden Hose Bibb. Push Button Bleeder Valve Releases trapped air. Clamps Fit Standard Air/Water Valves. New Fast Flow Valves, Large Bore Valves and Extensions or Standard Stem Valves.



75543

75543 TANK VALVE

1/8" MALE NPT For Pressure Tanks and Compressors, Air Lifts etc. requiring a dependable Air Valve. Max. Working Pressure 200 PSI.



75545

75367• 1/4" NPT

75368• 1/8" NPT

DRAIN COCK FOR COMPRESSOR TANK DRAIN



75367

75545 MINI FILTER - 1/4" NPT 32 CFM At 100 PSI 5 MICRON FILTER ELEMENT

Removes Airborne Contaminants (liquid, oil, water or dirt) from Air Lines.

AIR FITTINGS AND ACCESSORIES

AIR CHUCKS, MINI REGULATORS & MINI LUBRICATORS



75547



75546

75546 MINI REGULATOR

1/4" NPT 16 CFM AT 300 PSI 2-1/8" NPT GAUGE
PORTS 5 TO 125 PSI AT OUTLET

75547 MINI LUBRICATOR

1/4" NPT 12 CFM 150 PSI 1 OZ. BOWL
(Bowl not sold separately)

75504



75504 IN-LINE AIR TOOL OILER

1/4" NPT



75505

75505 IN-LINE AIR TOOL FILTER

1/4" NPT

75518

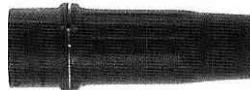

75518 REPLACEMENT FILTER

For filter Forney #75505



75340

75340 DIRECT LINE AIR CHUCK

1/4" Female NPT with Built in Shut Off.
(Cannot be used with inflator gauges.)



75349

75349 DUAL FOOT AIR CHUCK

1/4" NPT for Servicing Air Valves on Trucks, Buses and RV's with
Dual Wheels. Complete with Hang-up Hole.



75489

75489 AIR CHUCK WITH 1/4" ID HOSE BARB

75487



75487 SNAP-ON CHUCK CLIP

1/4" Female NPT. Built in Shut-Off Valve.



75488

75488 SNAP-ON CHUCK CLIP

Fits Forney 75487 and 75340.

AIR FITTINGS AND ACCESSORIES



75381



75380

75381 PLASTIC DOME TYPE TIRE VALVE CAP

75380• SCREWDRIVER TIRE VALVE CAP



75403

TUBELESS TIRE VALVE (PAIR)

75403	2" L x .625 rim hole
75513	1-1/4" L x .625 rim hole
75514	1-1/4" L x .453 rim hole
75516	2" L x .453 rim hole



75507

75507 TIRE REPAIR KIT



75509

75509 HEAVY-DUTY RADIAL TIRE REPAIR KIT



75511



75512

75511 SHORT TIRE VALVE CORE

75512 TIRE VALVE EXTENSION



75370

75370 FOUR-WAY TIRE VALVE REPAIR TOOL

Removes Intact or Broken Valve Cores. Repairs Cap and Core Threads.

AIR FITTINGS AND ACCESSORIES

BULK AIR HOSE & RECOIL AIR HOSE



PVC AIR HOSE IN SELECTED LENGTHS & SIZES

General purpose hose. High quality, economical, lightweight and very flexible. 0-150 range. 2:1 working pressure safety factor. Resists grease, oil, abrasion & weathering. 300 PSI. burst strength. Ideal for Service Stations, Garages, Farm use etc..

Temperature Range 15° F to 150° F
 Working Pressure @ 122° F 150 PSI
 Working Pressure @ 70° F 250 PSI

Cat. #	Dimensions	Male End
11052	1/4" x 6'	1/4"
75406	1/4" x 25'	1/4"
75407	1/4" x 50'	1/4"
75410	3/8" x 25'	1/4"
75411	3/8" x 50'	1/4"
75415	3/8" x 100'	1/4"
75420	1/2" x 25'	3/8"
75421	1/2" x 50'	3/8"

75412	Bulk 1/4" hose by the foot
75413	Bulk 3/8" hose by the foot



RECOIL AIR HOSE

Manufactured of tough abrasive resistant nylon, temp -20° to 175° F. Extends to 25 times its stored length. Coils up when not in use. Bright yellow with swivel assembly. Great garages, home shops & service stations etc.

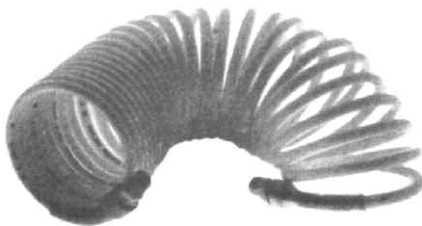

# Cat.	Dimension	Male End
75417	1/4" x 12 1/2'	1/4"
75418	1/4" x 25'	1/4"
11670	1/4" x 50'	1/4"
75425	3/8" x 25'	3/8"
11675	3/8" x 50'	3/8"



POLYURETHANE - RECOIL AIR - HOSE

11681	1/4" X 25'	1/4"
11685	3/8" X 25'	3/8"

AIR FITTINGS AND ACCESSORIES

75347 DUAL FOOT SERVICE GAUGE 10-150 LBS.

Designed for Heavy Duty use. Accurate and Dependable. Has 6" Extension to Reach the Inner and Outer Wheels of Duals. 2 Sided Nylon Bar Calibrated 20-130 psi. Hang-up Ring.



75347

75348 TRACTOR TIRE GAUGE

For Air and Liquid-Filled Tires. Pressure Range 5-45 lbs.



75348

75349 LOW PRESSURE TIRE GAUGE 1-20 LBS.

Low pressure readings at their best. Perfect for home garden tractors, golf carts, air springs, and ATVs. Calibrated 1-20 PSI in 1/2 lb. units. Carded. 10/master.



75349

75490 TIRE GAUGE

Straight, Easy to Read. 10-50 psi Pressure Scale. Pocket Clip.



75490

75491 ECONOMY TIRE GAUGE

Angled easy to read. 10 - 50 psi pressure scale. Pocket clip.



75491

75492 TRUCK ECONOMY TIRE GAUGE

Angled, Easy to Read. 20-120 psi Pressure Scale



75492

75493 DELUXE TIRE INFLATOR GAUGE

10-120 psi. Dual Foot, In-Line Design. Heavy Duty. Internal Gauge with Glass Viewing Window.



75493

75528 DIAL TIRE GAUGE 10-60 PSI.

Professional Model for Cars, Vans, & Light Trucks. Easy to Read. Automatic Reset. Pressure Release Valve. Drawn steel Casing. Nickel Plated Brass Chuck.



75528

TIRE GAUGES AND INFLATORS

BATTERY JUMPER CABLES & CHARGER CLAMPS

HEAVY-DUTY BATTERY JUMPER CABLES

Premium Fine Copper Wire WELDING CABLE CONSTRUCTION.
Super Battery Clamps on Both Ends. Complete with vinyl storage bag.

- 52865#4 Cable by 12'
- 52866#4 Cable by 16'
- 52867#4 Cable by 20'
- 52868#4 Cable by 25'



- 52869Economy Booster Cable Set 12'
- 52870#4 Twin Cables by 12'
- 52871#4 Twin Cables by 16'
- 52872#4 Twin Cables by 20'
- 52873#4 Twin Cables by 25'

- 52875#2 Cable by 12'
- 52876#2 Cable by 16'
- 52877#2 Cable by 20'
- 52878#2 Cable by 25'

BATTERY TERMINAL ASSORTMENT

- 54764 Assortment of 8 items with Display Tray
- 54765 Assortment of 77 items with Display Tray

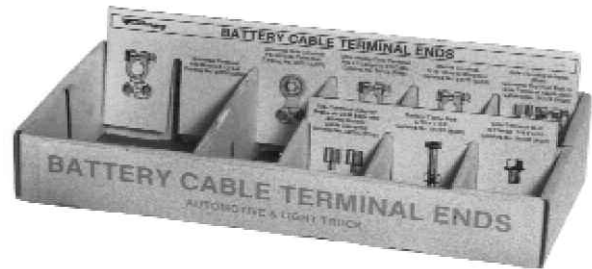

54770	54771	54772	54773
54774	54775	54781	54782



54766 UNIVERSAL TERMINALS
Regular duty (10/display card)

54767 UNIVERSAL TERMINALS
Heavy duty (10/display card)

BATTERY JUMPER CABLES & CHARGER CLAMPS

BATTERY TERMINAL 8 ga. to 1/0

High quality quickly installed replacement cable ends can be used to restore original configuration or can be used to convert from side post to top post battery or top post to side post battery.

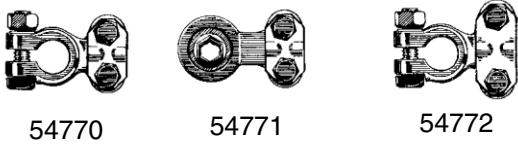

54770 Universal Top Post 60146 2 Per Card(54770)	54766 Universal Top Post (10 X 54770)
54771 Universal Side Post 60147 2 Per Card (54771)	54767 Universal Side Post (10 X 54772)
54772 H.D. Universal Battery Terminal	60148 2 Per Card(54772)

54773 MARINE BATTERY TERMINAL

Commonly used as marine terminals. Also used on some import autos and garden tractors. Best used in fresh water environments.

60149 2 Per Card (54773)

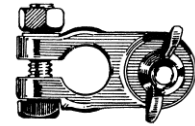

54774 SIDE TERMINAL ADAPTERS

Side Terminal adapters are the least expensive way to use a Top Post Battery in a vehicle equipped with Side Terminal Cables. Sold in pairs.

60150 1 Pair Per Card

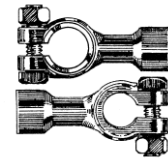

54775 - 54778 CONVERSION POSTS FOR SIDE TERMINALS

Conversion Posts replace the O.E.M. bolts that GM provides to connect the side terminals to your battery. Allows side terminal battery to be used with regular cable ends or excellent for booster terminals.

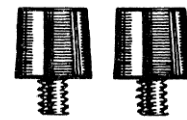

SOLDER BATTERY TERMINALS

Provides the corrosion resistance of brass in a terminal that is designed for solder installation. #4 - #1 standard wire gauge range.

54776	Solder Terminal - Straight
60153	2 Per Card (54776)
54777	Solder Terminal - Left/Right
60154	2 Per Card (54777)
60155	Side Terminal Posts Male (Pr)



NUTS & BOLTS FOR BATTERY TERMINALS

54781	Top Post 5/16" x 1 3/8"
60156	2 Per Card (54781)
54782	Side Post 3/8" x 5/16"
60157	2 Per Card (54782)

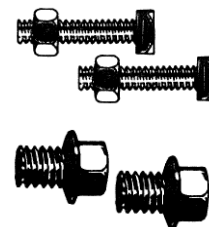

SOLID BRASS BATTERY TERMINALS

More conductive and stronger than lead. Will deliver more starting power. For auto, light truck and marine applications.

84785 Universal Brass Terminal	60157 2 Per Card (84785)
84786 Positive Brass Terminal	60152 1 Per Card (84786)
84787 Negative Brass Terminal	60152 1 Per Card (84787)

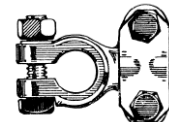

BATTERY JUMPER CABLES & CHARGER CLAMPS

BATTERY JUMPER CABLES & CHARGER CLAMPS

54727 TUNE-UP CLAMPS 50 AMP

Fine Quality, Copper Plated Battery and Tune-up Replacement Clip. With Red and Black Insulators.

- | |
|---|
| 59012 Negative Black Insulator |
| 59013 Positive Red Insulator |
| 54727 Packaged Set - 59012 and 59013 |



54732 REGULAR BATTERY CHARGER CLAMPS 200 AMP

A Good Quality, Medium Size, Copper Plated Battery Charger Clamp. With Red and Black Insulators. Sold by the Pair.

HEAVY DUTY BATTERY CHARGER CLAMPS

400 Amp. Rating. Heavy gauge steel, Zinc Plated, Red and Black insulated handles. Shark - Tooth jaws for extra tite grip. Complete with cable connector.

54718 Negative Black	54719 Positive Red
54722 Packaged (1 Red and 1 Black)	



54705 EXTRA HEAVY-DUTY BATTERY CHARGER CLAMP 500 AMP

Heavy-Duty, Copper Plated Steel Jaws with Extra Heavy Spring for Positive Clamping Power. Complete Clamp Insulated with Red or Black Vinyl Coating. For Heavy-Duty Charging Jobs.

54714 Negative Black	54716 Positive Red
54705 Packaged (1 Red and 1 Black)	



SOLID COPPER BOOSTER CLAMP 800 AMP RATING

Solid copper construction assures positive contact and durability. This is probably the best booster cable clamp money can buy. Cable connector included.

54724 Negative Black	54725 Positive Red
-----------------------------	---------------------------



BATTERY JUMPER CABLES & CHARGER CLAMPS

60340 OPENING CLIP INVENTORY - WITH INSULATORS

Contains three of each item.
Each package contains 2 clips and 2 insulators.



60343



60344



60345

- | | |
|------------|--|
| 60343..... | Test Clips Gen. Purpose, 5 Amp |
| 60344..... | Crocodile Clips, 5 Amp |
| 60345..... | Pee Wee Clips, 5 Amp |
| 60346..... | Econo Clips, 10 Amp |
| 60347..... | High Grade Clips, 20 Amp |
| 60348..... | Battery & Charger Clips Gen. Purpose
25 Amp |



60348



60347



60346

ALLIGATOR CLIPS & INSULATORS (RED & BLACK)

Cat. #	Width	Length	Description
54741	5/8"	2-7/16"	40 amps
54743	5/16"	1-1/2"	Pee-wee
54745	1/2"	2"	Usage multiple
54747	5/16"	2"	6-40 Screw
54749	5/16"	2-1/8"	6-40 Screw
54751	3/4"	3"	25 amps
54752	7/16"	2"	10 amps
54742	Insulator for number		54741
54744	Insulator for number		54743
54746	Insulator for number		54745
54748	Insulator for number		54747
54750	Insulator for number		54749



54740 CLIP ASSORTMENT

2 each of the 12 items above with Display Tray

TEST CLIPS AND CLAMPS

SPRING ASSORTMENTS

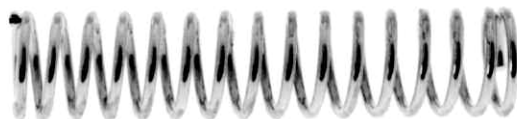

COMPRESSION SPRINGS

CAT.#	CENTURY#	OD Inches	Length Inches	Diam. Inches	No. In Pack	CAT.#	CENTURY#	OD Inches	Length Inches	Diam. Inches	No. In Pack
72600	10500	5/32	9/16	.123	6	72635	10702	9/16	1	.054	2
72601	10510	1/4	1/2	.035	6	72636	10704	1/2	1-1/2	.041	2
72602	10516	5/32	1	.011	6	72637	10706	9/16	1-3/8	.072	2
72603	10520	3/16	7/8	.016	6	72638	1071211/16		1-1/4	.092	2
72604	10526	3/16	1	.028	6	72639	10714	3/8	2-1/4	.062	2
72605	10530	7/32	1	.020	6	72640	10720	1/2	1-3/4	.062	2
72606	10532	3/16	1	.013	6	72641	10724	7/16	2	.054	2
72607	10550	3/16	1	.016	6	72642	1073013/32		2-3/4	.047	2
72608	10554	1/4	1	.020	6	72643	10736	1/2	2-3/4	.072	2
72609	10556	5/16	5/8	.026	6	72644	10740	5/8	2-1/2	.080	2
72610	10562	1/4	1	.035	6	72645	10742	5/8	2-3/4	.054	2
72611	10566	3/8	3/4	.032	6	72646	10750	3/4	2	.080	2
72612	10570	1/8	1-3/8	.014	6	72647	1075215/16		2	.080	2
72613	10576	5/32	1-3/8	.016	6	72648	1075623/32		3-1/2	.041	2
72614	10578	3/16	1-3/8	.013	6	72649	10766	9/16	3	.054	2
72615	10580	3/16	1-3/8	.028	6	72650	10782	5/8	3	.080	2
72616	10582	3/16	1-3/8	.016	6	72651	10792	7/8	3	.105	2
72617	10600	7/32	1-3/8	.020	4	72652	10802	1-3/8	4-3/8	.148	2
72618	10604	7/32	1-3/8	.023	4	72653	10806	1-1/2	3-1/4	.148	2
72619	10608	1/4	1-3/8	.020	4	72654	10814	1-3/8	2-1/2	.135	2
72620	10612	9/32	1-3/8	.028	4	72655	10818	1-1/8	4	.120	2
72621	10614	5/16	1-1/4	.041	4	72656	1082215/16		4	.148	2
72622	10624	3/8	1-1/8	.041	4	72657	10826	1	3-1/2	.120	2
72623	10632	7/16	1-1/16	.041	4	72658	10830	1-1/8	3	.105	2
72624	10650	7/32	1-3/4	.013	4	72659	10832	1	3	.120	2
72625	10652	7/32	1-3/8	.028	4	72660	108341-3/16		2-3/4	.120	2
72626	10660	5/16	1-3/4	.016	4	72661	10836	7/8	4	.080	2
72627	10664	11/32	1-1/2	.047	4	72662	10838	3/4	3-1/2	.080	2
72628	10668	3/8	1-1/2	.026	4	72663	10850	5/8	5	.091	2
72629	10672	3/8	1-3/4	.035	4	72664	10856	3/4	6	.091	2
72630	10676	7/16	2-1/8	.032	4	72665	1085811/16		6	.072	2
72631	10680	5/16	2	.047	4	72666	10864	7/8	6	.091	1
72632	10690	7/16	2-1/4	.041	2	72667	10874	1-3/8	6	.120	1
72633	10692	5/8	1-11/2	.041	2	72668	10878	5/8	9	.080	1
72634	10700	1/2	1	.062	2	72669	10892	1-1/8	7	.162	1

High quality steel line of springs cover a variety of uses in homes & industry. Including: screen doors, chaise lounges, toys, lawn & garden equipment, industrial and farm equipment, business machines, cars, trucks, boats, RV's, & many more. All springs zinc plated, baked for rust resistant finish, heat treated for performance & longevity. Made in U.S.A.

SPRING ASSORTMENTS



EXTENSION SPRINGS

CAT.#	CENTURY#	OD Inches	Length Inches	Diam. Inches	No. In Pack	CAT.#	CENTURY#	OD Inches	Length Inches	Diam. Inches	No. In Pack
72506	101	1/8	1-1/2	.015	2	72552	10193	3/8	4	.034	2
72507	105	5/32	1-1/2	.020	2	72553	10205	1/4	5	.034	2
72508	1013	7/32	1-1/2	.023	2	72554	10209	3/8	4-1/2	.028	2
72509	1019	1/4	1-1/2	.035	2	72555	10215	3/8	3-3/4	.041	2
72510	1023	9/32	1-1/2	.025	2	72556	10219	15/32	4-1/2	.041	2
72511	1025	5/16	1-1/2	.020	2	72557	10221	1/2	4-1/2	.062	2
72512	1029	11/32	1-1/2	.028	2	72558	10223	1/2	5	.072	2
72513	1031	7/16	1-1/2	.028	2	72559	10227	11/16	4-3/4	.091	2
72514	1033	7/16	1-1/2	.047	2	72560	10231	9/16	6	.072	2
72515	1051	1/8	1-7/8	.014	2	72561	10233	1/4	6	.034	2
72516	1055	5/32	1-7/8	.020	2	72562	10235	5/16	6	.028	2
72517	1063	7/32	1-7/8	.023	2	72563	10239	3/8	6-1/2	.047	2
72518	1067	1/4	1-7/8	.020	2	72564	10243	5/8	6-1/2	.054	2
72519	1069	1/4	1-7/8	.035	2	72565	10251	1-1/8	16	.105	1
72520	1073	9/32	1-7/8	.025	2	72566	10253	9/16	16-1/2	.054	1
72521	1077	11/32	1-7/8	.025	2	72567	10257	13/16	4-1/2	.091	2
72522	1081	7/16	1-7/8	.028	2	72568	10259	13/16	4	.120	2
72523	1083	7/16	1-7/8	.047	2	72569	10261	1-1/16	5-1/2	.120	1
72524	10103	1/8	2-1/2	.018	2	72570	10263	7/8	6	.091	1
72525	10105	5/32	2-1/2	.020	2	72571	10265	1-1/16	7	.105	1
72526	10111	3/16	2-1/2	.025	2	72572	10267	1-1/4	6-1/2	.162	1
72527	10115	1/4	2-1/2	.016	2	72573	10269	1	7	.135	1
72528	10117	1/4	2-1/2	.020	2	72574	10271	1-1/16	8-1/2	.080	1
72529	10119	1/4	2-1/2	.035	2	72575	10273	1-1/8	8-1/2	.148	1
72530	10131	7/16	2-1/2	.028	2	72576	10275	1-1/8	7-1/2	.091	1
72531	10133	7/16	2-1/2	.047	2	72577	10277	3/4	6-1/2	.091	1
72532	10135	7/16	2	.062	2	72578	10281	3/8	5-1/2	.062	2
72533	10139	7/16	3-1/2	.054	2	72579	10285	3/8	5	.034	2
72534	10141	5/8	2-1/2	.072	2	72580	10287	5/16	5	.031	2
72535	10143	9/16	3	.054	2	72581	10289	5/16	5	.034	2
72536	10155	5/16	3	.028	2	72582	10293	3/8	6-3/4	.062	1
72537	10157	1/4	3-1/4	.025	2	72583	10301	1-1/2	11-1/2	.135	1
72538	10161	7/16	2-3/4	.034	2	72584	10303	1	12	.105	1
72539	10163	7/16	3-1/2	.047	2	72585	10307	1-1/16	12	.135	1
72540	10165	1/2	1-5/8	.080	2	72586	10311	7/16	10-1/4	.041	1
72541	10171	3/4	2	.105	2	72587	10313	1/2	8-1/2	.047	1
72542	10173	3/4	2-1/4	.105	2	72588	10315	7/16	8-1/2	.047	1
72543	10175	3/4	2-7/16	.105	2	72589	10317	5/8	8-1/2	.091	1
72544	10177	3/4	2-5/8	.105	2	72590	10319	9/16	8-1/2	.054	1
72545	10179	9/16	2-7/8	.072	2	72591	10321	5/8	8-1/2	.062	1
72546	10181	5/8	3-1/4	.072	2	72592	10323	5/8	8-1/2	.080	1
72547	10183	9/16	4	.047	2	72593	10325	7/8	8-1/2	.062	1
72548	10185	3/4	3-1/2	.062	2	72594	10329	7/8	8-1/2	.105	1
72549	10187	3/4	3-7/8	.105	2	72595	10333	7/8	9	.135	1
72550	10189	3/4	3-1/8	.105	2	72596	10337	1	8-1/2	.120	1
72551	10191	3/4	3-3/4	.105	2	72597	10339	1-1/4	10	.148	1
						72598			Drawbar/Porch Swing Spring		1
						72599			Spring Assortment - 100 pcs.		1

SPRING ASSORTMENTS



SPRING CENTRE

72500 FORNEY SPRING DISPLAY - 217 Springs

Complete
Display
Packaged for
Self Service



Wall Hung
(Horizontal)

72501 FORNEY SPRING DISPLAY - 389 Springs

Complete
Display
Packaged for
Self Service

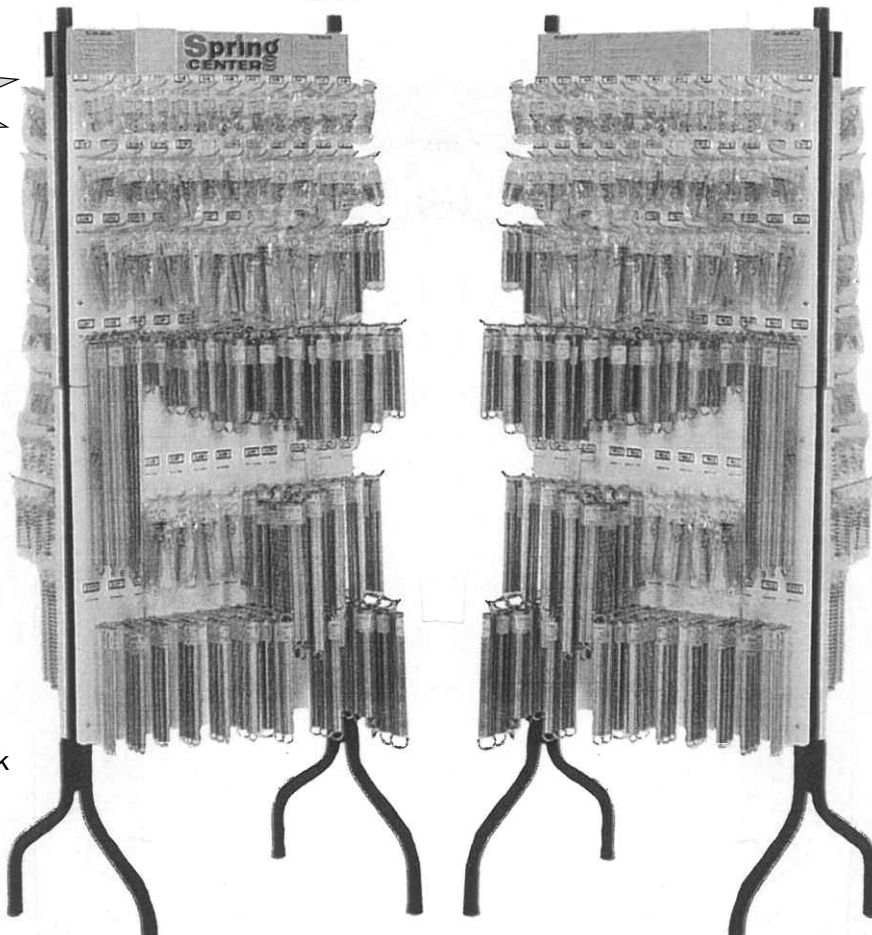

Back to Back
on Legs

PRESSURE WASHER FITTINGS, HOSES & ACCESSORIES

PRESSURE WASHER CENTRE

75101 PRESSURE WASHER ACCESSORIES DISPLAY RACK

Opening inventory includes
free display rack that comes
fully assembled and is ready
to sell right out of the box.

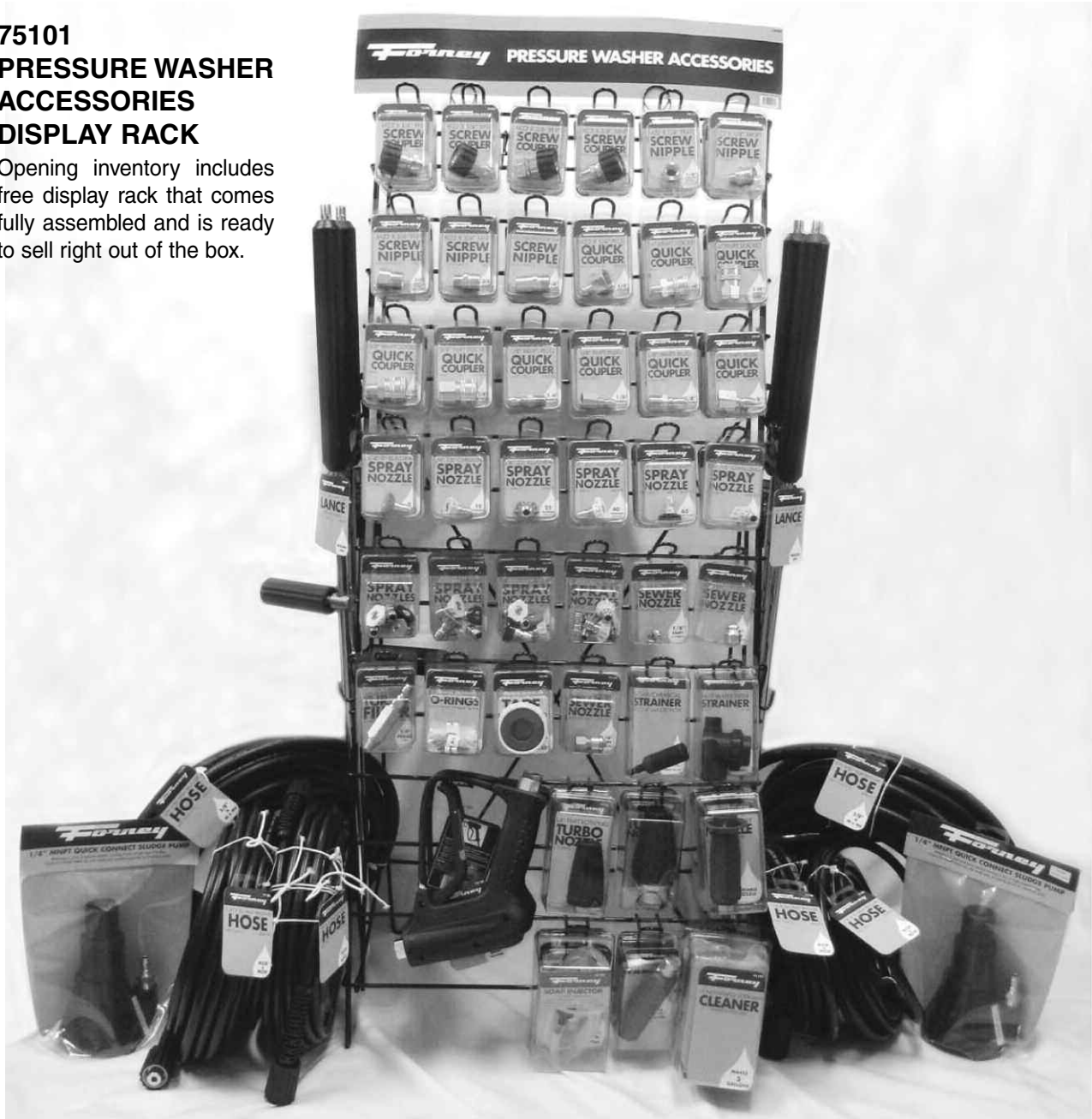

43 - Piece Pressure Washer Parts Opening Inventory

Includes 1 ea. Forney 75106, 75107, 75108, 75109, 75114, 75115, 75116, 75117, 75118, 75123, 75126, 75127, 75128, 75129, 75134, 75135, 75136, 75137, 75148, 75149, 75150, 75153, 75154, 75155, 75156, 75157, 75160, 75161, 75166, 75167, 75168, 75169, 75176, 75180, 75183, 75185, 75186, 75187, 75188, 75193, 75194, 75195, 75196

FREE 1 each 10260 Display Rack.

PRESSURE WASHER FITTINGS, HOSES & ACCESSORIES

PRESSURE WASHER ACCESSORIES

HP SCREW COUPLINGS

75106

HP Screw Coupling

1/4" FNPT x M22
300° F, 5800 PSI, cat. #75190
replacement o-ring



75107

HP Screw Coupling

1/4" MNPT x M22
300° F, 5800 PSI, cat. #75190
replacement o-ring



75108

HP Screw Coupling

3/8" FNPT x M22
300° F, 5800 PSI, cat. #75190
replacement o-ring

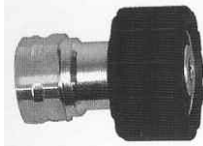

75109

HP Screw Coupling

3/8" MNPT x M22
300° F, 5800 PSI, cat. #75190
replacement o-ring



HP SCREW NIPPLES

75114

HP Screw Nipple

1/4" FNPT x M22
300° F, 5800 PSI

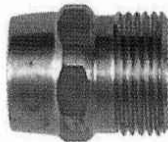

75115

HP Screw Nipple

1/4" MNPT x M22
300° F, 5800 PSI



75116

HP Screw Nipple

3/8" FNPT x M22
300° F, 5800 PSI

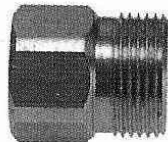

75117

HP Screw Nipple

3/8" MNPT x M22
300° F, 5800 PSI

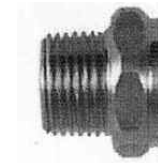

75118

HP Screw Nipple

1/4" FNPT x M22 Italian
300° F, 5800 PSI



75123

HP Quick Coupler Plug

1/4" Male Plug x M22
300° F, 5800 PSI



75126

HP Quick Coupler (brass)

1/4" MNPT
300° F, 5500 PSI



75127

HP Quick Coupler (brass)

1/4" FNPT
300° F, 5500 PSI

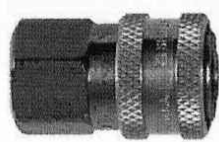

75128

HP Quick Coupler (brass)

3/8" MNPT
300° F, 4200 PSI



75129

HP Quick Coupler (brass)

3/8" FNPT
300° F, 4200 PSI

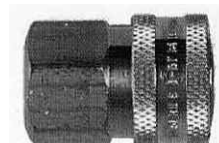

PRESSURE WASHER ACCESSORIES

HP QUICK COUPLER PLUGS

75134

HP Quick Coupler Plug
1/4" MNPT
300° F, 5500 PSI



75135

HP Quick Coupler Plug
1/4" FNPT
300° F, 5500 PSI

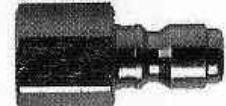

75136

HP Quick Coupler Plug
3/8" MNPT
300° F, 5500 PSI

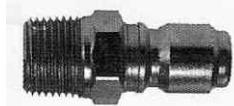

75137

HP Quick Coupler Plug
3/8" FNPT
300° F, 5500 PSI



75140

Non-rotating Sewer Nozzle (SS)
1/4" FNPT
300° F, 5500 PSI

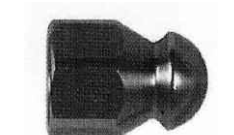

75141

Non-rotating Sewer Nozzle (SS)
1/8" FNPT
300° F, 5500 PSI

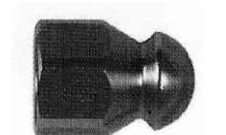

75142

Rotating Sewer Nozzle (SS)
1/4" FNPT, 3000 PSI
Orifice of 4.5



SOAP & SPRAY NOZZLES

75150

Soap Nozzle (black)
1/4" quick connect x 65° flat
spray, 4.0 orifice, 300° F

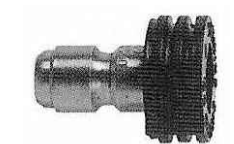

75153

Soap Nozzle (yellow)
1/4" quick connect x 15° chisel
spray, 4.5 orifice, 300° F

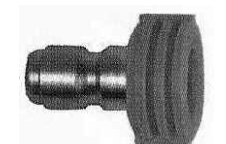

75154

Soap Nozzle (yellow)
1/4" quick connect x 15° chisel
spray, 5.5 orifice, 300° F



75155

Soap Nozzle (green)
1/4" quick connect x 25°
flushing spray, 4.5 orifice,
300° F



75156

Soap Nozzle (white)
1/4" quick connect x 40° wide
spray, 4.5 orifice, 300° F

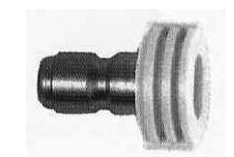

75157

Soap Nozzle (red)
1/4" quick connect x 0° blasting
spray, 4.5 orifice, 300° F



PRESSURE WASHER ACCESSORIES

SOAP & SPRAY NOZZLES

75148

Spray & Soap Nozzles

5-pack assortment
1/4" quick connect, 4.0
orifice, (0,15, 25, 40
degrees soap nozzles &
one soap nozzle)



75149

Spray & Soap Nozzles

5-pack assortment
1/4" quick connect, 4.5
orifice, (0,15, 25, 40
degrees soap nozzles &
one soap nozzle)



NOZZLES & PARTS

75160

Rotating Spray Turbo Nozzle

1/4" FNPT, 190° F,
4.5 orifice, 3600 PSI



75161

Rotating Spray Turbo Nozzle

1/4" FNPT, 212° F,
4.5 orifice, 3600 PSI



75167

Adjustable Side Handle

fits 1/4" wand



75172

Soap & Chemical Strainer with built-in SS
check valve, fits 1/4" and
3/8" hose



75173

Inlet Water Filter Strainer

1/2" FNPT x 1/2" MNPT,
140° F, 145 PSI



75176

Turbo Nozzle Filter Strainer

1/4" quick connect, 190° F,
5000 PSI



75166

Multi-Reg Nozzle

1/4" FNPT x 0 to 80°, flat
spray, 300° F, 4.5 orifice,
3000 PSI



75190 O-RING FOR HP SCREW COUPLING

75191 O-RING FOR 1/4" HP SCREW COUPLING

75192 O-RING FOR 3/8" HP SCREW COUPLING

PRESSURE WASHER ACCESSORIES

PRESSURE WASHER HOSES

75183

**50 ft. Pressure Washer
Hose**

3/8" MNPT, 3000 PSI



75185

**1/4" x 50' Pressure
Washer Hose**

with M22 Male & M22 Female
ends, 3000 PSI, 140° F



75186

**1/4" x 25' Pressure
Washer Hose**

with M22 Male & M22 Female
ends, 3000 PSI, 140° F



75187 1/4" m (4.0) SLUDGE PUMP

4000 PSI



75187

75188

75188 1/4" m (4.5) SLUDGE PUMP

4000 PSI



**75189 25 ft. DISCHARGE HOSE FOR
SLUDGE PUMP**

75189



**75193 PREMIUM PRESSURE WASHER
DETERGENT**

(makes 5 gallons.)



75193

75194 15 pc. O-RING KIT

(5 each - 75190, 75191, 75192)

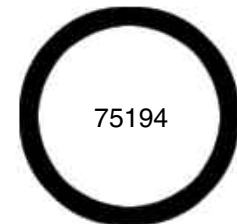

75194

75195 1/2" x 260' TEFLON TAPE



75195

75196 UPSTREAM SOAP INJECTOR

(1.5-4.0 GPM) with 4-ft Suction Hose



75196

PRESSURE WASHER ACCESSORIES

MAGSWITCH PRODUCTS

MAGSWITCH® GROUND CLAMPS

Magswitch® ground clamps utilize advanced switchable magnetic technology to allow welders to quickly set up, weld and move on to the next job. Easily attaches to flat or round stock with a quick and easy connect/disconnect. Simply place it on the work surface and a 1/2 turn of the knob turns the magnet completely on or off. Grounds instantly. No need to tack on ground tabs or waste time searching for a ground location. No batteries or electricity required. Turn the ground clamp completely off for removal and cleaning. Available in 200, 300 and 600 Amp models.

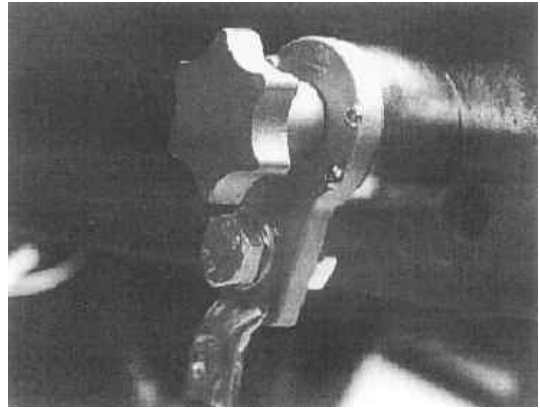

58558 INDUSTRIAL PRO® MAGSWITCH® 200 AMP GROUND CLAMP

200 AMP capacity at 100% duty cycle rating.

58559 INDUSTRIAL PRO® MAGSWITCH® 300 AMP GROUND CLAMP

300 AMP capacity at 100% duty cycle rating.



58560 INDUSTRIAL PRO® MAGSWITCH® 600 AMP GROUND CLAMP

600 AMP capacity at 100% duty cycle rating.

MAGSWITCH PRODUCTS

MAGSWITCH® GROUND CLAMPS

Magswitch® products are built with the world's most advanced switchable magnet technology. They are light weight, very strong, precise and easy to use. Magswitch® products exhibit up to 5 times the power of other magnet systems (up to 250 times its own weight). They can easily be turned on or completely off with the simple turn of a manual knob or t-handle - makes cleaning a breeze. No batteries or electricity required. The strength of the Magswitch® increases as you turn the handle towards the fully on position.

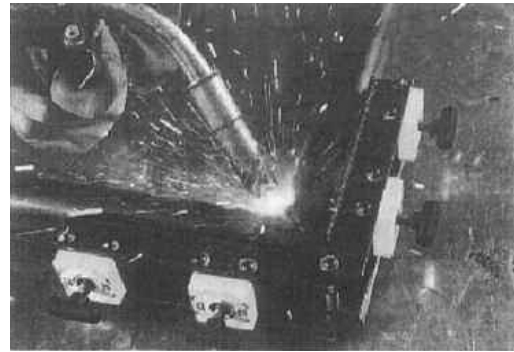

INDUSTRIAL PRO® MAGSWITCH® 30MM POWER HOOK

Safe working loads up to 25 lbs. (11.4 kg). Quickly secure and holds just about anything. Perfect for temporary holding of lines, hoses, lights, tools or loose nuts and bolts. Easily positioned on flat or round surfaces. For use on the job site or in the home shop. A must have for all auto mechanics.

58553 - Industrial Pro® Magswitch® 30mm Power Hook

58588 - Industrial Pro® Magswitch® 50mm Power Hook

INDUSTRIAL PRO® MAGSWITCH® 30MM MAGSQUARE®

Perfect for fabrication with ferrous metals. Grips on three sides. Up to 150 lbs. (68 kg) breakaway on 1/4" (6.35 mm) thick steel. Fast, strong and precise positioning. Use MagSquares® to mount work-holding jigs. Pre-tapped holes (M5) on all sides for mounting to angles.

58564 - Industrial Pro® Magswitch® 30mm MagSquare®

58585 - Industrial Pro® Magswitch® 50mm MagSquare®



INDUSTRIAL PRO® MAGSWITCH® 30MM 90° ANGLE SQUARE

8" (203.2 mm) welding angles featuring 2 Forney 58564 30 mm MagSquares®. Each MagSquares® has up to 150 lbs (68 kg) holding power. Will accept two more 30 mm MagSquare®. Each MagSquare® has pre-tapped holes, are reversible for inside or outside holding, and can be repositioned for various sizes of steel. Enables perfect 90° angle welding and fabrication for all steel plate, pipe, flat stock, bar and round stock, as well as angle iron holding.

58565 - Industrial Pro® Magswitch® 30mm 90° Angle Square

58586 - Industrial Pro® Magswitch® 50mm 90° Angle Square



MAGSWITCH PRODUCTS

MAGSWITCH® WELDING & FAB TOOLS

INDUSTRIAL PRO® MAGSWITCH® ADJUSTABLE BOOMERANGLE

8" (203.2 mm) welding angles featuring 2 pivoting Forney 58564 MagSquares® that enable fast and precise welding and fabrication at unlimited angles. Each MagSquare® has up to 150 lbs (68 kg) of holding power. The MagSquares® are pre-set for 90° holding, but can easily pivot for inside and outside holding at any angles. Allows unlimited-angle welding and fabrication for all steel plate, flat stock, bar and round stock, as well as angle iron holding.

58567 - Industrial Pro® Magswitch® 30mm Adjustable BoomerAngle

58587 - Industrial Pro® Magswitch® 50mm Adjustable BoomerAngle



MAGSWITCH® MEDIUM-DUTY LIFTERS

8100025



8100025 MAGSWITCH® EXTEND-A-LIFTER

Handle sharp, heavy steel and cast iron with ease. Never bend down again with the 27" tall handle. Handle locks in position for secure holding. Lifts and holds a safe working load of 70 lbs (31.7 kg). Foot plate makes activating the magnet easy - just step and turn. No batteries or electricity require. Lightweight. Hold flat non-flexing material. No need to bend over and pick up metal by hand. Rated to hold up to 70 lbs (31.7 kg).

8100089 MAGSWITCH® MEDIUM-DUTY LIFTER

This new technology lets you turn magnetic power on and off with a half-turn of a handle. You can pick up and move heavy, cumbersome objects with ease. Lightweight and compact. More effective than the competition on thinner material. Holds flat and round non-flexing material. Available in 50 mm and 70 mm sizes.

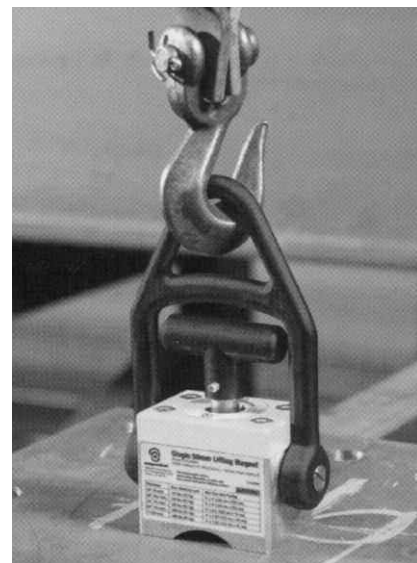

8100089

INDEX

- A -

Abrasives	
Aluminum Type 27	57
Asphalt	58
Bench Grinder	60
Blue Zirconia Flap Discs	59
Carbide Burs	74
Circular Wire Wheels	72
Concrete	58
Cup Brushes	67 & 70
Cut-Off Wheels (Metal)	58, 62 & 75
Emery Cloth/Sand Screen	61
End Brushes	69 & 73
Flap Wheels	62 & 66
Hubless (Type 27)	57
Masonry Cut-Off Wheels	58
Microabrasives	75
Mounted Grinding Point	73 - 75
Mounted Grinding Wheels, w/Mandrel & Screw	73 - 75
Packaged Wire Wheels & Cup Brushes	67 & 68
Rotary File & Wood Rasps	74
Safety Information	63
Sand Discs	61 & 75
Stainless Steel Brushes	39 - 41
Threaded Hub (Type 27 & 28)	57
1/4" Shank Wire Cup & End Brushes for Power Drills	68 & 69
Acid Core Solder	10
Adapters	
Reducer	60
Regulator to Tank	25
Side Terminal	101
Air Accessory Interchange Chart	94
Air Chuck	96
Air Compressor Repair Parts	
Air/Water Adapter	95
Cast Brass Check Valve	93
Hose Repair Kit	95
Mini Filter, Mini Regulator, Mini Lubricator	93 & 95
Pressure Gauge/Switches	95
Safety Valves	93
Tank Valve, Tank Manifolds, 3-in-1 Manifold	93 & 95
Air Fittings & Accessories	85 - 99
Air Hose (Poly Flex)	2
Airline Swivels	91
Aluminum (Welding & Brazing)	
Brazing Rod	7
Electrodes	7
Anti Spatter	11
ARO Design (Air Fittings)	87
Auto Darkening Helmets	77

- B -

Battery	
Clamps	102
Terminals	100 & 101
Blades - Hack Saws	46
Blow Guns	92
Brass Fittings (Air)	90 & 91
Brass Cross/Tee	93
Brass Safety Valves	93
Brazing	
Rod	9
Brushes	
Chipping Hammer Replacement	38
Circular Brush	67 - 73
End	69 & 73

Flux Soldering	14
Long Handle	39 & 40
Parts Cleaning	41 & 42
Shoe Handle	39
Stainless Steel	39 & 40
Stringer Bead Wire	72
Tube	41
V-GROOVE	40
Wire, Brass	40
Wire Handle	41
Buffing Wheel	65
Bumper Plate Kit	18

- C -

Cable	
Jumper	99
Lug/Butt Connectors	17 & 18
Output Jacks & Plugs	18
Insulators	18 & 21
Recept - Portable and Wall	20
Splicers	18
Welding - Bulk	17
Cast Rod	7 & 8
Check Valve	93
Chipping Hammers	38
Chuck, Dual Foot	96
Clamps	
C-Clamp - Locking Plier Style	45
C-Clamp - Malleable Iron	45
Conversion Chart - Air Accessories	94
Couplers	23 - 25, 85 - 87
Crimping Tool	25
Crimped Wire Brush	69 & 73
Cup Brushes	70
Cut-Off Wheel Kit	58
Cutting Attachments	30 - 33
Cutting Tip Cross Reference Chart	36
Cutting Tips	
Oxy-Acetylene/Propane	27 & 28, 35 & 37
Cutting Tools	21

- D -

Discs	
Abrasive	58 - 62
Diamond Cutting Blades	64
Sanding	61 & 75
Trim Kut	65
Drill Sets	21

- E -

Ear Plugs	
Disposable	83
Muffs	83
Reusable	83
Electrical Test Clips	103
Electrodes and Rods	
Acetylene	9
Arc	7 - 9
Aluminum	9
Brazing	9
Cast	8
Hard Surfacing	7
Mild Steel	5 & 6
Nickel	8
Stainless Steel	9
Emery Cloth/Sand Screen	61
Eye Bolt, Screw Hook & Screw Eye Centre	54

- F -

Face Shield - Grinding	34 & 81
Replacement Shield and Headband	81
Ferrules for Oxy-Acetylene Hose	23
Files	48 & 49
Flashback Arrestor	24
Flint Lighters	22
Renewals	22
Flux	
Brush - Bulk/Skin-Packed	14
Liquid	13 & 14
Fuse - Multi Tester	20

- G -

Gas Cylinders - Oxy-Acetylene, Argon, CO ₂	26
Gauge	
Oxy-Acetylene	26
Tire	99
Glasses - Safety	82
Gloves	84
Goggles - Oxy-Acetylene	80
Grab Hooks	51
Grinding	
Bench	60
Disc, Abrasive	61 - 65
Wheel Dresser and Parts	60
Ground Clamps - Steel & Brass	16

- H -

Hack Saw Blades, Frames	46
Hammers, Chipping	38
Hardfacing Electrodes and Rod	7
Harris Style Tips	35
Headgear	78
Hearing Muffs	83
Heating Tips	
Rosebud/Oxy-Acetylene	27, 28 & 35
Helmets	76 & 77
Lens	79
Welding	76 & 77
Hook Centre	51
Hose-Air	
Adapters	90
Couplers	86 - 89
Coupler Test Bar	90
Fittings	85 - 94
Recoil	98
Splicers	90
Hose - Oxy-Acetylene	
Braces	23
Check Valves	24
Connectors	24
Couplers	23
Ferrules	23
Nipples	23
Nuts	23 & 24
Oxy-Acetylene Fittings	23 - 25
Repair Parts	23 - 25
Regulator Fittings	24

- I - J - K -

Insert Bits	46 & 47
Industrial Milton (Air Fittings)	86
Interchange Chart (Air Fittings)	94
Jacks, Welding Repair	18
J-B Weld	14
Jumper Cables, Battery Kits	100
Bumper Plate	18
Four Way Easy Pick	43
Knotted Wire Brush	70
Knotted Wire Wheel	69

INDEX

- L -

Lens	
Helmet - Welding	79
Acetylene - Welding	79
Lincoln Air Fittings	89
Linking Centre	52
Locking Plier - C-Clamp, Welding	45
Lug Tray	19
Lugs - Cable - Bulk/Skin -Packed	19

- M -

Magnetic Level	43
Magnetic Scribe	44
Mag Switches	112 - 114
Manifolds (Tank)	93
Mandrel	58
Manual - Welding	24
Marking Pencil	44
Soapstone and Refills	44
Thin Line and Refills	44
Marquette Style Tips	49
Masks, Dust	83
Masonry Cut-Off Wheels	58
Mig Gun Replacement Parts, Nozzle,	
Contact Tips, Mig Pliers	3 & 4
Mig Wire	12
Mixer Assemblies	28, 30, 32, 33 & 35
Mounted Flap Wheels	66
Mounted Grinding Wheels	73
Skin-Packed and Tray	73
Mounted Points	73
Skin-Packed and Tray	73
Multi-Purpose Magnets	45
Multi-Testers	20

- N - O -

Nipples	23 & 25
Nozzles	
Rosebud Heating	27, 28 & 35
Tweco Nozzles	4
Welding - Brazing	27 & 35
Nozzle Gel	11
Oxy-Acetylene/Propane	
Couplers	23
Gauges	26
Goggles	79 - 82
Hose Couplers	23
Hose and Repair Parts	23
Lens	79
Lighters and Renewals	22
Mixer Assemblies	28, 30, 32, 33 & 35
Regulators	30 - 33
Reverse Flow Check Valves	24
Rosebud Heating	27, 28 & 35
Tips - Cutting	27 & 28

- P - Q -

Paint Markers	1
Panel Cutter Cut-Off Wheels	58
Pick Repair Kit (4-Way)	43
Plugs	
Ear	83
Power Pintype and Crowfoot	20
Sure Grip - Male and Female	18
Plumbers Torch Kit/Accessories	23
Pressure Gauges	
Oxy-Acetylene - High/Low	26
Pressure Gauges, Switches (Air)	93
Pressure Washer Accessories	107 - 111
Pro Flame Oxy-Acetylene Torch Kit	33
Propane Tips - Oxy-Acetylene	35 & 36

- R -

Receptacle, Power - Portable, Wall	19
Reducer Adapter	90 & 91
Reducing Bushings	60
Reference Chart	
High-speed Angle Grinders	71
Regulator	
Acetylene	30 - 33
Argon, Air	3
Oxygen	30 - 33
Repair Kits - Oxy-Acetylene	25
Repair Links	50
Respirators	83
Rod - Acetylene	9
Aluminum	9
Brazing	9
Cast	8
Hardfacing	7
Holder - Leather	5
Low Hydrogen	5
Mild Steel	10
Specialty	7
Stainless Steel	7
Roofer's Torch Kit	46
Rotary Files, Cutters, Rasps	74 & 75

- S -

Safety Equipment	
Dust Masks	83
Gloves	84
Goggles	80 & 81
Grinding Shields and Parts	34 & 81
Headgear, Ratchet	78
Helmets	76 & 77
Lens	79
Respirators	83
Safety Glasses	82
Safety Information	
(Wire Brushes & Grinding Wheels)	63
Scribe and Replacement Tips	43
Scribe with Magnetic Top	44
Shackles, Swivels & Clevis Centre	52
Shop Flame Torch Kit II	30
Shop Flame Heavy Duty Torch Kit	31
Shop Tools	38 - 47
Shuts	50
Small Slip and Grab Hooks	51
Snap Hook Centre	51
Soapstone - Holders and Refills	44
Solder	10
Silver	13 & 14
Solid Wire	16
Soldering Iron	13
Spanner Wrench	61
Spectacles - Safety	82
SpeedyBond	14
Springs	
Extension & Compression	104 - 106
Stainless Steel Wire Brushes	39 & 40
Storage Containers	
Rod/Polypropylene	13
Stringer Bead Twist	72

- T -

Tank Valve	93
Terminals - Battery	100
Thimbles	50
Tips	
Cleaner	22
Cutting	27, 28, 35, 37
Drills and Replacements	22

Airco	37
Harris	35
Purox	37
Smith	37
Victor Journeyman Style	28
Victor Style	27
Tip Drill Set	22
Tire Gauges	99
Tire Valve Repair Tool	97
Torch Handles	30 - 33
Victor	30 & 31
Torch Kits	
1705 Victor Shop Flame	30
Tote-A-Torch Portable 1753	29
1705 Shop Flame II	30
1711 Shop Flame Heavy-Duty	31
1680 - 1687 Pro Flame	32 & 33
1720 Plumber's Torch	34
1723 Uni-Flame	34
Trim Kut	65
True-Flate Design (Air Fittings)	87
Turnbuckle Centre	56

- U - V - W -

U-Bolt Centre	53
Universal Design (Air Fittings)	89
Utility Hardware Centre	50 - 56
Victor Style Tips	27
Welder - Anti-Spatter	11
Wheels	
Abrasive	57 - 59
Cut-Off	62
Grinding	57 - 62
Wire Rope Clips	50
Wrenches	
Cylinder	26
Spanner	61
Tank	26

Forney

Service You Expect.
From a Company You Can Depend On.



FORNEY CANADA

Regina, Saskatchewan • Hawkesbury, Ontario

TSP Total Support Program