

INDEX

#850 FHP Sheave & Split Taper Bushing Assort.....	3-28	Browning Cast Iron FHP Sheaves.....	3-38
1 Groove Sheaves.....	3-20 to 3-21	Browning Idler Bushings.....	3-33
2AKH Series Sheaves.....	3-12	Browning Split Taper Bushings.....	3-30
2BKH Series Sheaves.....	3-13	Browning Steel Hubs.....	3-34
2BK-HS Series Sheaves.....	3-17	Browning V Drives.....	3-1
2TB Gripbelt Sheaves.....	3-6	Browning Variable Speed Drives.....	3-35 to 3-36
"358" Gripbelt Drives.....	3-10	BS Series Sheaves.....	3-11
"358" Gripbelt Sheaves.....	3-10	Bushed Sprockets.....	3-69 to 3-73
3TB Gripbelt Sheaves.....	3-7	Bushings	
3TC Gripbelt Sheaves.....	3-9	Browning Bushings.....	3-29
40 Roller Chain Sprockets 1/2" Pitch.....	3-65	Browning Idler Bushings.....	3-33
4TB Gripbelt Sheaves.....	3-8	Browning Split Taper Bushings.....	3-30
50 Roller Chain Sprockets 5/8" Pitch.....	3-65	QD Bushings.....	3-31
60 Roller Chain Sprockets 3/4" Pitch.....	3-66	Taper Bore Bushings.....	3-32
80 Roller Chain Sprockets 1" Pitch.....	3-66	Bushing Type DRC Chain Couplings.....	3-99
Aetna Idlers.....	3-53	Case-IH Socket Tool.....	3-26
Agricultural Type Idler Sprockets.....	3-90	Cast & Steel Sprockets.....	3-86
AS Series Sheaves.....	3-11	Chains	
"B" Type Sprockets.....	3-58 to 3-64	Chain Pullers.....	3-87
Bearings		Black Ace Troubleshooting Guide.....	3-27
Bearing Assemblies.....	3-25	Covers & Replacement Chain.....	3-100
Mounted Bearings.....	3-107 to 3-108	Economical Roller Chain Holder.....	3-87
Bearing Assemblies.....	3-25	Idlemaster Tighteners for Roller Chains & Belts....	3-23
Belts		Replacement Chain.....	3-100
Flanged Flat Belt.....	3-53	Roller Chain Tool.....	3-89
V-Belt Idlers.....	3-53	Snugulator Tighteners for Roller Chains.....	3-22
Browning V Drives.....	3-1	Traditional Chain Tool.....	3-89
Belt Drives		Chain Pullers.....	3-87
Synchronous Belt Drives.....	3-47	Collars	
BK Series Sheaves.....	3-15	Set Collars.....	3-91
BKH Series Sheaves.....	3-13	Couplers	
BK-HS Series Sheaves.....	3-12, 3-17	Shaft Couplers.....	3-93
BK-S Series Sheaves.....	3-14	Coupler Hubs.....	3-52
Black Ace Troubleshooting Guide.....	3-27	Couplings	
Browning 1 VP Cast Iron Sheaves.....	3-39	Bushing Type DRC Chain Couplings.....	3-99
Browning 2 VP Cast Iron Sheaves.....	3-40	Flexible Couplings.....	3-94 to 3-95
Browning Bushings.....	3-29	Jaw Type Couplings.....	3-96

INDEX

Couplings (continued)

"R-Flex" Couplings Selection.....3-104

"R-Flex" Couplings.....3-102 to 3-103

Sleeve Couplings.....3-99

Covers & Replacement Chain.....3-100

Die Cast Pulleys and Hardware Display Board.....3-43

Die Cast Spoke Pulleys.....3-42

Die Cast Standard Pulleys.....3-41

Die Cast Step Pulleys.....3-42

Displays

Idler Sprocket Display.....3-90

Weld-On Display Assortment.....3-81

Weld-On Sprocket, Hub and Pulley Display.....3-82

Drives

"358" Gripbelt Drives.....3-10

Browning Variable Speed Drives.....3-35 to 3-37

Poly-V Drives.....3-48

Roller Chain Drives.....3-55 to 3-56

Economical Roller Chain Holder.....3-87

Economical Zinc Plated Idler Pulleys.....3-54

Elevator Chain Sprockets.....3-25

Feeder Chain Drive Sprockets.....3-24

Finished Bore Chain Sprockets.....3-65

Flanged Flat Belt.....3-53

Flexible Couplings.....3-94 to 3-95

Gears

Stock Gears.....3-106

Gripbelt.....3-3 to 3-10

Hubs

Browning Steel Hubs.....3-34

Coupler Hubs.....3-52

Idler Weld Hub.....3-52, 3-79

Split Taper & QD Weld-On Hubs.....3-80

Weld-On Hubs.....3-51, 3-78

Idlemaster Tighteners for Roller Chains & Belts.....3-23

Idlers

Aetna Idlers.....3-53

Idlers (continued)

Idler Rollers.....3-25

Round Belt Idlers.....3-53

Sprocket Idlers.....3-88

Straight Idlers.....3-53

Idler Pulley Display.....3-54

Idler Rollers.....3-25

Idler Sprocket Display.....3-90

Idler Weld Hub.....3-52, 3-79

Interchange Information.....3-44

Jaw Type Couplings.....3-96

Mandrels.....3-45

MBL & 2MBL (A-B & 4L-5L V-Belts).....3-18 to 3-19

Mounted Bearings.....3-107 to 3-108

Plate Steel Idler Sprockets.....3-88

Poly-V Drives.....3-48

Pulleys

Die Cast Pulleys and Hardware Display Board.....3-43

Die Cast Spoke Pulleys.....3-42

Die Cast Standard Pulleys.....3-41

Die Cast Step Pulleys.....3-42

Economical Zinc Plated Idler Pulleys.....3-54

Idler Pulley Display.....3-54

Interchange Information.....3-44

Steel Wire Rope Pulleys.....3-49

Weld-On Pulleys.....3-50

QD Bushings.....3-31

Replacement Chain.....3-100

"R-Flex" Couplings.....3-102 to 3-103

"R-Flex" Coupling Selection.....3-104

Roller Assemblies.....3-24

Roller Chain Tool.....3-89

Roller Chain Drives.....3-55 to 3-56

Round Belt Idlers.....3-53

Set Collars.....3-91

Shaft Couplers.....3-93

INDEX

Sheaves

#850 FHP Sheave & Split Taper Bushing Assort....3-28

1 Groove.....3-20 to 3-21

2TB Gripbelt Sheaves.....3-6

2AKH Series.....3-12

2BK-HS Series.....3-17

2BKH Series.....3-13

"358" Gripbelt Sheaves.....3-10

3TB Gripbelt Sheaves.....3-7

3TC Gripbelt Sheaves.....3-9

4TB Gripbelt Sheaves.....3-8

AS Series.....3-11

BK Series.....3-15

BK-HS Series.....3-12, 3-17

BK-S Series.....3-14

BKH Series.....3-13

Browning 1VP Cast Iron Sheaves.....3-39

Browning 2VP Cast Iron Sheaves.....3-40

Browning Cast Iron FHP Sheaves.....3-38

BS Series.....3-11

Gripbelt.....3-3 to 3-10

MBL & 2MBL (A-B & 4L-5L V-Belts).....3-18 to 3-19

Steel FHP Sheaves.....3-11

Synchronous Belt Drive Sheaves.....3-46

TB Gripbelt Sheaves.....3-4 to 3-8

Sleeve Couplings.....3-99

Snugulator Tighteners for Roller Chains.....3-22

Socket Tools

Case-IH Socket Tool.....3-26

Speed Reducers.....3-109

Speed Reducers.....3-109

Split Taper & QD Weld-On Hubs.....3-80

Sprockets

40 Roller Chain Sprockets 1/2" Pitch.....3-65

50 Roller Chain Sprockets 5/8" Pitch.....3-65

60 Roller Chain Sprockets 3/4" Pitch.....3-66

80 Roller Chain Sprockets 1" Pitch.....3-66

Sprockets (continued)

Agricultural Type Idler Sprockets.....3-90

"B" Type Sprockets.....3-58 to 3-64

Bushed Sprockets.....3-69 to 3-73

Cast & Steel Sprockets.....3-86

Elevator Chain Sprockets.....3-25

Feeder Chain Drive Sprockets.....3-24

Finished Bore Chain Sprockets.....3-65

Plate Steel Idler Sprockets.....3-88

Steel Single Sprockets.....3-67 to 3-73

Weld-On Sprockets.....3-83 to 3-86

Sprocket Idlers.....3-88

Steel FHP Sheaves.....3-11

Steel Single Sprockets.....3-67 to 3-73

Steel Wire Rope Pulleys.....3-49

Stock Gears.....3-106

Straight Idlers.....3-53

Synchronous Belt Drives.....3-47

Synchronous Belt Drive Sheaves.....3-46

Taper Bore Bushings.....3-32

TB Gripbelt Sheaves.....3-4 to 3-8

Torque Limiters.....3-75 to 3-76

Traditional Chain Tool.....3-89

Transmission Clutches, Brakes and Other

Power Transmission Products.....3-74

V-Belt Idlers.....3-53

Weld-On Display Assortment.....3-81

Weld-On Hubs.....3-51, 3-78

Weld-On Pulleys.....3-50

Weld-On Sprockets.....3-83 to 3-86

Weld-On Sprocket, Hub and Pulley Display.....3-82

BROWNING V DRIVES

**World's Largest Selection of V-Belts, Sheaves and Bushings...
Now with B5V, the most significant advance in belt drives since the V-Groove.**

Browning offers the most extensive V-drive line available anywhere, which means maximum economy, versatility and prompt availability for your every application...truly the right drive every time!

With the introduction of the revolutionary B5V, Browning has brought 1990's technology to the V-drive design. B5V packs into only 120 components what previously required some 500 different inventory items. And, you can mix and match B5V with many present drive components for maximum flexibility.



LVP Variable Speed Sheave



Multiple Sheave



MVP Variable Speed Sheave



358 Sheave

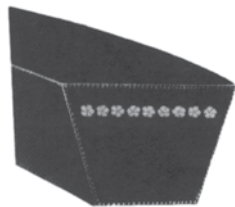
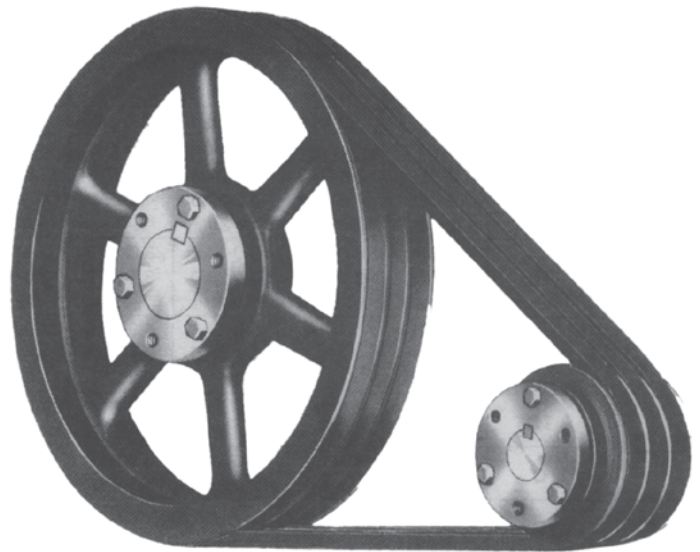

Super Gripbelt



Premium Griptwist

When you specify Browning, you select from the broadcast range of V-drive ratios and centres in the world - more than double the selection available from any other source.

- Over 2100 stock sizes in multiple groove sheaves, far more than any other manufacturer.
- Full range of sizes in two bushing types: the popular Browning split taper and the QD. Choose the replaceable bushing that best suits the application - no other manufacturer offers this choice.
- Variable speed sheaves through 750 HP, precision balanced to provide smooth vibration-free performance.
- "358" sheaves stocked in a range of fixed and variable pitch sizes.
- All types of belting - classical, "358", Gearbelt, Poly-V, Gripnotch and premium Griptwist belts.
- Automated computer software program, BROWNING/EDGE, generates V-drive selections in seconds.

**Westward Parts has available a full line of V Drives.
Please contact your nearest branch for details.**

GRIPBELT SHEAVES

Classical Gripbelt Sheaves - Bushing Type

BELT SIZE	TYPE		NO. OF GROOVES										
			1	2	3	4	5	6	7,8	10	12		
	AKH	DD Bore	2.8 - 18.0 1/2" - 1 1/2"	2.8 - 18.0 1/2" - 1 1/2"									
A	AK	DD Bore*	1.8 - 18.0 3/8" - 1 7/16"	1.8 - 18.0 1/2" - 1 7/16"									
	TA	DD Bore	3.0 - 24.5 1/2" - 2 11/16"	3.0 - 24.5 1/2" - 2 11/16"	3.0 - 24.5 1/2" - 2 11/16"	3.0 - 24.5 1/2" - 2 11/16"							
	BKH	DD Bore	2.8 - 18.4 1/2" - 1 1/2"	3.0 - 18.4 1/2" - 1 1/2"	3.9 - 18.4 1/2" - 1 1/2"								
	BK	DD Bore*	2.2 - 18.4 3/8" - 1 7/16"	2.3 - 18.4 1/2" - 1 7/16"	2.3 - 3.6 5/8" - 1 1/8"								
A-B	B5V	A DD Bore B DD Bore	3.8 - 27.3 4.2 - 27.8 1/2" - 2 7/16"	3.8 - 27.3 4.2 - 27.8 1/2" - 2 7/16"	3.8 - 27.3 4.2 - 27.8 1/2" - 2 7/16"	3.8 - 27.3 4.2 - 27.8 1/2" - 2 7/16"							
	TB	A DD Bore B DD Bore	3.0 - 37.5 3.4 - 38.0 1/2" - 2 11/16"	3.0 - 37.5 3.4 - 38.0 1/2" - 2 11/16"	3.0 - 37.5 3.4 - 38.0 1/2" - 2 11/16"	3.0 - 37.5 3.4 - 38.0 1/2" - 2 11/16"	3.0 - 37.5 3.4 - 38.0 3/4" - 2 5/8"	3.0 - 37.5 3.4 - 38.0 3/4" - 2 5/8"					
	B	A DD Bore B DD Bore		5.0 - 37.5 5.4 - 38.0 3/4" - 3 3/4"	5.0 - 37.5 5.4 - 38.0 3/4" - 3 3/4"	5.0 - 37.5 5.4 - 38.0 3/4" - 3 3/4"	5.0 - 37.5 5.4 - 38.0 3/4" - 3 3/4"	6.6 - 37.5 7.0 - 38.5 1 1/8" - 3 3/4"	6.6 - 37.5 7.0 - 38.0 1 1/8" - 3 3/4"	5.0 - 37.5 5.4 - 38.0 1" - 4 1/4"	5.0 - 37.5 5.4 - 38.0 1" - 5"		
C	TC	DD Bore	7.0 - 24.0 3/4" - 2 11/16"	7.0 - 24.0 3/4" - 2 11/16"	7.0 - 24.0 3/4" - 2 11/16"	7.0 - 24.0 1" - 2 5/8"	7.0 - 24.0 1" - 2 5/8"	7.0 - 24.0 1" - 2 5/8"					
	C	DD Bore	5.6 - 6.0 1/2" - 1 3/4"	5.6 - 44.0 1/2" - 3 3/4"	5.6 - 50.0 3/4" - 4 1/4"	5.6 - 50.0 3/4" - 5"	9.0 - 50.0 1 1/8" - 5"	9.0 - 50.0 1 3/4" - 5"	7.0 - 50.0 1 3/8" - 5"	8.0 - 50.0 1 3/8" - 5"	9.0 - 50.0 1 7/8" - 5"		
D	D	DD Bore				12.0 - 33.0 1 3/8" - 4 1/4"	12.0 - 33.0 1 3/8" - 4 1/4"	12.0 - 48.0 1 7/8" - 4 3/16"	12.0 - 48.0 1 7/8" - 5"	12.0 - 48.0 1 7/8" - 5"	12.0 - 48.0 1 7/8" - 5"	12.0 - 20.0 2 7/16" - 5"	

*AK & BK are finished bore type

"358" Gripbelt Sheaves

BELT SIZE	TYPE		NO. OF GROOVES										
			1	2	3	4	5	6	8	10	12, 14, 16		
	Bushing Type	PD Bore	2.6 - 24.95 3/8" - 2 11/16"	2.6 - 24.95 3/8" - 2 11/16"	2.6 - 33.45 3/8" - 3 3/4"	2.6 - 33.45 3/8" - 3 3/4"	4.7 - 33.45 1/2" - 3 3/4"	4.7 - 33.45 3/4" - 3 3/4"	4.7 - 33.45 1" - 4 1/4"	4.7 - 33.45 1" - 4 1/4"			
3V	Finished Bore	PD Bore	2.6 - 3.3 5/8" - 7/8"	2.6 - 3.3 3/4" - 1 1/8"	2.6 - 3.3 7/8" - 1 1/8"	2.6 - 3.3 7/8" - 1 3/8"							
5V	Bushing Type	PD Bore	4.3 - 27.9 1/2" - 2 7/16"	4.3 - 27.9 1/2" - 3 3/4"	4.3 - 49.9 1/2" - 5"	4.3 - 49.9 1/2" - 5"	4.3 - 49.9 3/4" - 5"	7.0 - 49.9 1" - 5"	7.0 - 49.9 1" - 5"	7.9 - 49.9 1 3/8" - 5"			
8V	Bushing Type	PD Bore				12.3 - 63.8 1 11/16" - 5"	12.3 - 63.8 1 11/16" - 5"	12.3 - 63.8 1 11/16" - 5"	12.3 - 63.8 1 7/8" - 7 7/16"	12.3 - 63.8 2 3/8" - 7 7/16"	12.3 - 63.8 2 7/16" - 7 7/16"		

Classical and "358" Gripbelt Sheaves are available in either of two bushing types: Split Taper or QD.

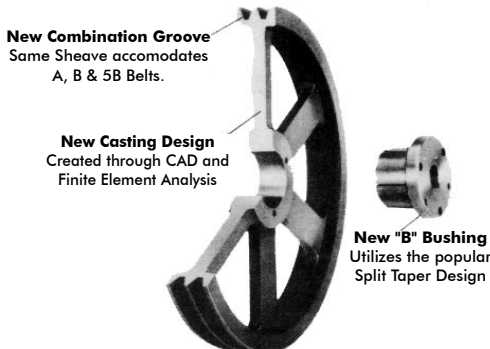

B5V serves 90% of all 10-75 HP applications!

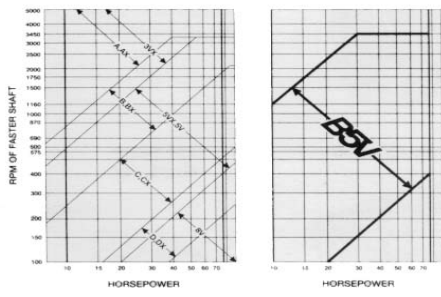

GRIPBELT SHEAVES

Westward Parts stocks a complete line of Gripbelt Sheaves and Variable Pitch Sheaves

Gripbelt Sheaves Feature:

- Cast iron construction.
- Accept split taper bushings.
- Accurately machined.
- Statically balanced.
- Easy to mount and remove.
- Clamp fit on shaft.
- TB sheaves have combination groove that accepts both A & B Section v-belts.
- TB sheaves accept the P1, P2 & Q1 Browning bushing with a bore range from:
 - $1/2'' - 1\ 3/4''$ on the P1 bushing
 - $3/4'' - 1\ 3/4''$ on the P2 bushing
 - $3/4'' - 2\ 11/16''$ on the Q1 bushing
- TC sheaves accept the Q1 bushing.
- All sheaves are key to key drive for maximum horsepower capability.

Sheaves

Westward Parts also has available a full line of both QD and taper lok style sheaves. Contact your nearest branch for price & availability.

Red Deer, AB

6517 67 Street T4P 1A3
Phone (403) 347-2200
Fax 1-800-661-4508

Regina, SK

201 Henderson Drive S4N 7E2
Phone (306) 721-2113
Fax 1-800-721-2977

Winnipeg, MB

1435 St. James Street R3H 0W9
Phone (204) 697-2444
Fax 1-800-257-8338

GRIPBELT SHEAVES

Browning TB Gripbelt Sheaves (with split taper bushings)

Standard Keyseats

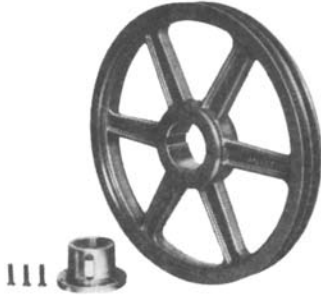

BORE RANGE	KEYSEAT
1/2" - 9/16"	1/8" - 1/16"
5/8" - 7/8"	3/16" - 3/32"
15/16" - 1 1/4"	1/4" - 1/8"
1 5/16" - 1 3/8"	5/16" - 5/32"
1 7/16" - 1 3/4"	3/8" - 3/16"
1 13/16" - 2 1/4"	1/2" - 1/4"
2 5/16" - 2 11/16"	5/8" - 5/16"

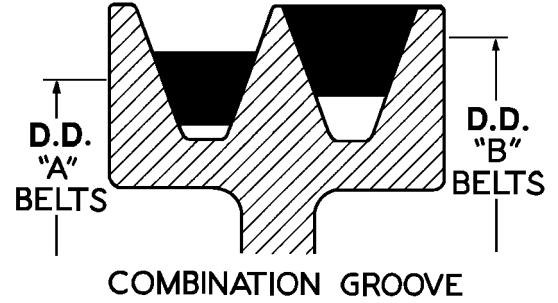

1 3/8" bore bushings also available with 3/8" x 3/16" keyseat.

Bushing Dimensions

PART NO.	DIMENSIONS									BORE RANGE	WT. LBS.
	M	L	G	X	E	T	U	D	H		
P1	2 3/16"	1 15/16"	5/8"	1 5/16"	1/4"	1 17/32"	13/32"	1 15/16"	3	1/2" - 1 3/4"	1.25
P2	3 3/16"	2 15/16"	5/8"	2 5/16"	1/4"	2 17/32"	13/32"	1 15/16"	3	3/4" - 1 3/4"	1.5
Q1	2 25/32"	2 1/2"	3/4"	1 3/4"	9/32"	1 31/32"	17/32"	2 7/8"	4 1/8"	3/4" - 2 11/16"	3.5

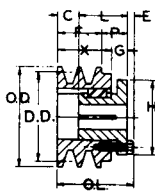

Type 2

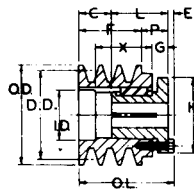

Type 3

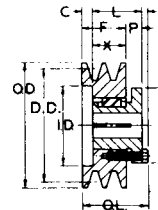

Type 5

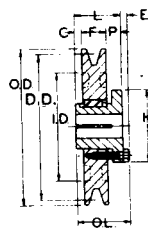

Type 10

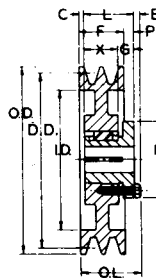

Type 13

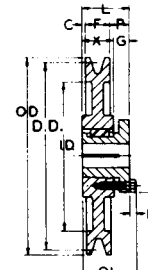

Type 16

GRIPBELT SHEAVES

Browning 1TB Gripbelt Sheaves (with split taper bushings)

Specifications - Stock "TB" Sheaves

PART NO.		DIAMETERS				TYPE	1 GROOVE, F=1"				DIMENSIONS				WEIGHT LESS BUSHING
SHEAVE	BUSHING	DATUM "A"	DATUM "B"	OUTSIDE	INSIDE		OL	L	P	C	H	G	X	E	
PTP 1TB34	P1	3.0"	3.4"	3.75"	-	2	2 5/16"	1 15/16"	1 1/16"	1/8"	3"	5/8"	1 7/16"	1/4	2.0
PTP 1TB36	P1	3.2	3.6	3.95	-	2	2 5/16	1 15/16	1 1/16	1/8	3	5/8	1 7/16	1/4	2.3
PTP 1TB38	P1	3.4	3.8	4.15	-	2	2 5/16	1 15/16	1 1/16	1/8	3	5/8	1 7/16	1/4	2.6
PTP 1TB40	P1	3.6	4.0	4.35	-	10-Sol.	2 3/16	1 15/16	5/8	5/16	3	-	-	1/4	2.1
PTP 1TB42	P1	3.8	4.2	4.55	-	10-Sol.	2 3/16	1 15/16	5/8	5/16	3	-	-	1/4	2.4
PTP 1TB44	P1	4.0	4.4	4.75	-	10-Sol.	2 3/16	1 15/16	5/8	5/16	3	-	-	1/4	2.8
PTP 1TB46	P1	4.2	4.6	4.95	-	10-Sol.	2 3/16	1 15/16	5/8	5/16	3	-	-	1/4	3.1
PTP 1TB48	P1	4.4	4.8	5.15	-	10-Sol.	2 3/16	1 15/16	5/8	5/16	3	-	-	1/4	3.5
PTP 1TB50	P1	4.6	5.0	5.35	-	10-Sol.	2 3/16	1 15/16	5/8	5/16	3	-	-	1/4	3.9
PTP 1TB52	P1	4.8	5.2	5.55	-	10-Sol.	2 3/16	1 15/16	5/8	5/16	3	-	-	1/4	4.1
PTP 1TB54	P1	5.0	5.4	5.75	-	10-Sol.	2 3/16	1 15/16	5/8	5/16	3	-	-	1/4	4.6
PTP 1TB56	P1	5.2	5.6	5.95	-	10-Sol.	2 3/16	1 15/16	5/8	5/16	3	-	-	1/4	5.1
PTP 1TB58	P1	5.4	5.8	6.15	-	10-Sol.	2 3/16	1 15/16	5/8	5/16	3	-	-	1/4	5.6
PTP 1TB60	P1	5.6	6.0	6.35	4 1/2	10-Web	2 3/16	1 15/16	5/8	5/16	3	-	-	1/4	6.0
PTP 1TB62	P1	5.8	6.2	6.55	4 11/16	10-Web	2 3/16	1 15/16	5/8	5/16	3	-	-	1/4	5.5
PTP 1TB64	P1	6.0	6.4	6.75	4 7/8	10-Web	2 3/16	1 15/16	5/8	5/16	3	-	-	1/4	5.8
PTP 1TB66	P1	6.2	6.6	6.95	5 1/16	10-Web	2 3/16	1 15/16	5/8	5/16	3	-	-	1/4	5.9
PTP 1TB68	P1	6.4	6.8	7.15	5 5/16	10-Web	2 3/16	1 15/16	5/8	5/16	3	-	-	1/4	6.1
PTP 1TB70	P1	6.6	7.0	7.35	5 1/2	16-Arm	2 3/16	1 15/16	25/32	5/32	3	5/8	1 5/16	1/4	6.4
PTP 1TB74	P1	7.0	7.4	7.75	5 15/16	16-Arm	2 3/16	1 15/16	25/32	5/32	3	5/8	1 5/16	1/4	7.3
PTP 1TB80	P1	7.6	8.0	8.35	6 1/2	16-Arm	2 3/16	1 15/16	25/32	5/32	3	5/8	1 5/16	1/4	7.8
PTP 1TB86	P1	8.2	8.6	8.95	7 1/16	16-Arm	2 3/16	1 15/16	25/32	5/32	3	5/8	1 5/16	1/4	8.6
PTP 1TB90	P1	8.6	9.0	9.35	7 1/2	16-Arm	2 3/16	1 15/16	25/32	5/32	3	5/8	1 5/16	1/4	8.9
PTP 1TB94	P1	9.0	9.4	9.75	7 15/16	16-Arm	2 3/16	1 15/16	25/32	5/32	3	5/8	1 5/16	1/4	9.1
PTP 1TB110	P1	10.6	11.0	11.35	9 7/16	16-Arm	2 3/16	1 15/16	25/32	5/32	3	5/8	1 5/16	1/4	11.1
PTP 1TB124	Q1	12.0	12.4	12.75	10 15/16	16-Arm	2 25/32	2 1/2	1 1/8	3/8	4 1/8	3/4	1 3/4	9/32	17.8
PTP 1TB136	Q1	13.2	13.6	13.95	12 1/16	16-Arm	2 25/32	2 1/2	1 1/8	3/8	4 1/8	3/4	1 3/4	9/32	18.2
PTP 1TB154	Q1	15.0	15.4	15.75	13 15/16	16-Arm	2 25/32	2 1/2	1 1/8	3/8	4 1/8	3/4	1 3/4	9/32	20.3
PTP 1TB160	Q1	15.6	16.0	16.35	14 1/2	16-Arm	2 25/32	2 1/2	1 1/8	3/8	4 1/8	3/4	1 3/4	9/32	22.0
PTP 1TB184	Q1	18.0	18.4	18.75	16 15/16	16-Arm	2 25/32	2 1/2	1 1/8	3/8	4 1/8	3/4	1 3/4	9/32	27.5
PTP 1TB200	Q1	19.5	20.0	20.35	18 1/2	16-Arm	2 25/32	2 1/2	1 1/8	3/8	4 1/8	3/4	1 3/4	9/32	27.2
PTP 1TB250	Q1	24.5	25.0	25.35	23 1/2	16-Arm	2 25/32	2 1/2	1 1/8	3/8	4 1/8	3/4	1 3/4	9/32	42.4
PTP 1TB300	Q1	29.5	30.0	30.35	28 1/2	16-Arm	2 25/32	2 1/2	1 1/8	3/8	4 1/8	3/4	1 3/4	9/32	56.0
PTP 1TB380	Q1	37.5	38.0	38.35	36 1/2	16-Arm	2 25/32	2 1/2	1 1/8	3/8	4 1/8	3/4	1 3/4	9/32	78.0

GRIPBELT SHEAVES

Browning 2TB Gripbelt Sheaves (with split taper bushings)

For use with all "A" and "B" Section Belts

Specifications - Stock "TB" Sheaves

PART NO.		DIAMETERS				TYPE	2 GROOVES, F=1 3/4"				DIMENSIONS				WEIGHT LESS BUSHING
SHEAVE	BUSHING	DATUM "A"	DATUM "B"	OUTSIDE	INSIDE		OL	L	P	C	H	G	X	E	
PTP 2TB34	P1	3.0"	3.4"	3.75"	-	2	3 1/16"	1 15/16"	1 1/16"	7/8"	3"	5/8"	2 3/16"	1/4	2.9
PTP 2TB36	P1	3.2	3.6	3.95	-	2	3 1/16	1 15/16	1 1/16	7/8	3	5/8	2 3/16	1/4	3.8
PTP 2TB38	P1	3.4	3.8	4.15	2 5/16	5	2 5/8	1 15/16	5/8	7/16	3	-	1 5/16	1/4	3.0
PTP 2TB40	P1	3.6	4.0	4.35	2 1/2	5	2 5/8	1 15/16	5/8	7/16	3	-	1 5/16	1/4	3.8
PTP 2TB42	P1	3.8	4.2	4.55	2 11/16	5	2 5/8	1 15/16	5/8	7/16	3	-	1 5/16	1/4	3.9
PTP 2TB44	P1	4.0	4.4	4.75	2 7/8	13-Sol.	2 3/16	1 15/16	3/16	0	3	5/8	1 5/16	1/4	3.9
PTP 2TB46	P1	4.2	4.6	4.95	3 1/16	13-Sol.	2 3/16	1 15/16	3/16	0	3	5/8	1 5/16	1/4	4.5
PTP 2TB48	P1	4.4	4.8	5.15	3 5/16	13-Sol.	2 3/16	1 15/16	3/16	0	3	5/8	1 5/16	1/4	5.3
PTP 2TB50	P1	4.6	5.0	5.35	3 1/2	13-Sol.	2 3/16	1 15/16	3/16	0	3	5/8	1 5/16	1/4	5.6
PTP 2TB52	P1	4.8	5.2	5.55	3 11/16	13-Sol.	2 3/16	1 15/16	3/16	0	3	5/8	1 5/16	1/4	6.1
PTP 2TB54	P1	5.0	5.4	5.75	3 7/8	13-Sol.	2 3/16	1 15/16	3/16	0	3	5/8	1 5/16	1/4	6.5
PTP 2TB56	P1	5.2	5.6	5.95	4 1/16	13-Sol.	2 3/16	1 15/16	3/16	0	3	5/8	1 5/16	1/4	7.4
PTP 2TB58	P1	5.4	5.8	6.15	4 5/16	13-Sol.	2 3/16	1 15/16	3/16	0	3	5/8	1 5/16	1/4	8.0
PTP 2TB60	P1	5.6	6.0	6.35	4 1/2	13-Sol.	2 3/16	1 15/16	3/16	0	3	5/8	1 5/16	1/4	8.9
PTP 2TB62	P1	5.8	6.2	6.55	4 11/16	13-Web	2 3/16	1 15/16	3/16	0	3	5/8	1 5/16	1/4	7.6
PTP 2TB64	P1	6.0	6.4	6.75	4 7/8	13-Web	2 3/16	1 15/16	3/16	0	3	5/8	1 5/16	1/4	7.8
PTP 2TB66	P1	6.2	6.6	6.95	5 1/16	13-Web	2 3/16	1 15/16	3/16	0	3	5/8	1 5/16	1/4	8.3
PTP 2TB68	P1	6.4	6.8	7.15	5 5/16	13-Web	2 3/16	1 15/16	3/16	0	3	5/8	1 5/16	1/4	8.8
PTP 2TB70	Q1	6.6	7.0	7.35	5 1/2	13-Web	2 25/32	2 1/2	3/4	0	4 1/8	3/4	1 3/4	9/32	11.1
PTP 2TB74	Q1	7.0	7.4	7.75	5 15/16	13-Web	2 25/32	2 1/2	3/4	0	4 1/8	3/4	1 3/4	9/32	11.5
PTP 2TB80	Q1	7.6	8.0	8.35	6 1/2	13-Web	2 25/32	2 1/2	3/4	0	4 1/8	3/4	1 3/4	9/32	12.8
PTP 2TB86	Q1	8.2	8.6	8.95	7 1/16	13-Web	2 25/32	2 1/2	3/4	0	4 1/8	3/4	1 3/4	9/32	16.0
PTP 2TB90	Q1	8.6	9.0	9.35	7 1/2	13-Arm	2 25/32	2 1/2	3/4	0	4 1/8	3/4	1 3/4	9/32	15.1
PTP 2TB94	Q1	9.0	9.4	9.75	7 15/16	13-Arm	2 25/32	2 1/2	3/4	0	4 1/8	3/4	1 3/4	9/32	15.5
PTP 2TB110	Q1	10.6	11.0	11.35	9 7/16	13-Arm	2 25/32	2 1/2	3/4	0	4 1/8	3/4	1 3/4	9/32	18.9
PTP 2TB124	Q1	12.0	12.4	12.75	10 15/16	13-Arm	2 25/32	2 1/2	3/4	0	4 1/8	3/4	1 3/4	9/32	21.1
PTP 2TB136	Q1	13.2	13.6	13.95	12 1/16	13-Arm	2 25/32	2 1/2	3/4	0	4 1/8	3/4	1 3/4	9/32	23.0
PTP 2TB154	Q1	15.0	15.4	15.75	13 15/16	13-Arm	2 25/32	2 1/2	3/4	0	4 1/8	3/4	1 3/4	9/32	24.8
PTP 2TB160	Q1	15.6	16.0	16.35	14 1/2	13-Arm	2 25/32	2 1/2	3/4	0	4 1/8	3/4	1 3/4	9/32	27.0
PTP 2TB184	Q1	18.0	18.4	18.75	16 15/16	13-Arm	2 25/32	2 1/2	3/4	0	4 1/8	3/4	1 3/4	9/32	32.3
PTP 2TB200	Q1	19.5	20.0	20.35	18 1/2	13-Arm	2 25/32	2 1/2	3/4	0	4 1/8	3/4	1 3/4	9/32	42.3
PTP 2TB250	Q1	24.5	25.0	25.35	23 1/2	13-Arm	2 25/32	2 1/2	3/4	0	4 1/8	3/4	1 3/4	9/32	50.3
PTP 2TB300	Q1	29.5	30.0	30.35	28 1/2	13-Arm	2 25/32	2 1/2	3/4	0	4 1/8	3/4	1 3/4	9/32	68.8
PTP 2TB380	Q1	37.5	38.0	38.35	36 1/2	13-Arm	2 25/32	2 1/2	3/4	0	4 1/8	3/4	1 3/4	9/32	95.5

GRIPBELT SHEAVES

Browning 3TB Gripbelt Sheaves (with split taper bushings)

For use with all "A" and "B" Section Belts

Specifications - Stock "TB" Sheaves

PART NO.		DIAMETERS				TYPE	3 GROOVES, F=2 1/2"				DIMENSIONS				WEIGHT LESS BUSHING
SHEAVE	BUSHING	DATUM "A"	DATUM "B"	OUTSIDE	INSIDE		OL	L	P	C	H	G	X	E	
PTP 3TB34	P2	3.0"	3.4"	3.75"	2"	3	3 13/16"	2 15/16"	1 1/16"	5/8"	3"	5/8"	2 5/16"	1/4	3.8
PTP 3TB36	P2	3.2	3.6	3.95	2 1/16	3	3 13/16	2 15/16	1 1/16	5/8	3	5/8	2 5/16	1/4	4.4
PTP 3TB38	P1	3.4	3.8	4.15	2 5/16	5	3 3/8	1 15/16	5/8	1 3/16	3	-	1 5/16	1/4	3.8
PTP 3TB40	P1	3.6	4.0	4.35	2 1/2	5	3 3/8	1 15/16	5/8	1 3/16	3	-	1 5/16	1/4	4.5
PTP 3TB42	P1	3.8	4.2	4.55	2 11/16	5	3 3/8	1 15/16	5/8	1 3/16	3	-	1 5/16	1/4	4.9
PTP 3TB44	P1	4.0	4.4	4.75	2 7/8	13-Sol.	2 3/4	1 15/16	0	9/16	3	5/8	1 5/16	1/4	5.1
PTP 3TB46	P1	4.2	4.6	4.95	3 1/16	13-Web	2 3/4	1 15/16	0	9/16	3	5/8	1 5/16	1/4	6.0
PTP 3TB48	P1	4.4	4.8	5.15	3 5/16	13-Web	2 3/4	1 15/16	0	9/16	3	5/8	1 5/16	1/4	6.3
PTP 3TB50	P1	4.6	5.0	5.35	3 1/2	13-Web	2 3/4	1 15/16	0	9/16	3	5/8	1 5/16	1/4	6.9
PTP 3TB52	P1	4.8	5.2	5.55	3 11/16	13-Web	2 3/4	1 15/16	0	9/16	3	5/8	1 5/16	1/4	7.5
PTP 3TB54	P1	5.0	5.4	5.75	3 7/8	13-Web	2 3/4	1 15/16	0	9/16	3	5/8	1 5/16	1/4	8.3
PTP 3TB56	P1	5.2	5.6	5.95	4 1/16	13-Web	2 3/4	1 15/16	0	9/16	3	5/8	1 5/16	1/4	9.0
PTP 3TB58	P1	5.4	5.8	6.15	4 5/16	13-Web	2 3/4	1 15/16	0	9/16	3	5/8	1 5/16	1/4	9.6
PTP 3TB60	P1	5.6	6.0	6.35	4 1/2	13-Web	2 3/4	1 15/16	0	9/16	3	5/8	1 5/16	1/4	10.5
PTP 3TB62	P1	5.8	6.2	6.55	4 11/16	13-Web	2 3/4	1 15/16	0	9/16	3	5/8	1 5/16	1/4	9.4
PTP 3TB64	P1	6.0	6.4	6.75	4 7/8	13-Web	2 3/4	1 15/16	0	9/16	3	5/8	1 5/16	1/4	9.5
PTP 3TB66	P1	6.2	6.6	6.95	5 1/16	13-Web	2 3/4	1 15/16	0	9/16	3	5/8	1 5/16	1/4	10.0
PTP 3TB68	P1	6.4	6.8	7.15	5 5/16	13-Web	2 3/4	1 15/16	0	9/16	3	5/8	1 5/16	1/4	10.4
PTP 3TB70	Q1	6.6	7.0	7.35	5 1/2	13-Web	3 5/32	2 1/2	3/8	3/8	4 1/8	3/4	1 3/4	9/32	13.0
PTP 3TB74	Q1	7.0	7.4	7.75	5 15/16	13-Web	3 5/32	2 1/2	3/8	3/8	4 1/8	3/4	1 3/4	9/32	13.3
PTP 3TB80	Q1	7.6	8.0	8.35	6 1/2	13-Web	3 5/32	2 1/2	3/8	3/8	4 1/8	3/4	1 3/4	9/32	15.3
PTP 3TB86	Q1	8.2	8.6	8.95	7 1/16	13-Web	3 5/32	2 1/2	3/8	3/8	4 1/8	3/4	1 3/4	9/32	18.9
PTP 3TB90	Q1	8.6	9.0	9.35	7 1/2	13-Arm	3 5/32	2 1/2	3/8	3/8	4 1/8	3/4	1 3/4	9/32	18.1
PTP 3TB94	Q1	9.0	9.4	9.75	7 15/16	13-Arm	3 5/32	2 1/2	3/8	3/8	4 1/8	3/4	1 3/4	9/32	18.0
PTP 3TB110	Q1	10.6	11.0	11.35	9 7/16	13-Arm	3 5/32	2 1/2	3/8	3/8	4 1/8	3/4	1 3/4	9/32	21.3
PTP 3TB124	Q1	12.0	12.4	12.75	10 15/16	13-Arm	3 5/32	2 1/2	3/8	3/8	4 1/8	3/4	1 3/4	9/32	25.4
PTP 3TB136	Q1	13.2	13.6	13.95	12 1/16	13-Arm	3 5/32	2 1/2	3/8	3/8	4 1/8	3/4	1 3/4	9/32	27.4
PTP 3TB154	Q1	15.0	15.4	15.75	13 15/16	13-Arm	3 5/32	2 1/2	3/8	3/8	4 1/8	3/4	1 3/4	9/32	29.8
PTP 3TB160	Q1	15.6	16.0	16.35	14 1/2	13-Arm	3 5/32	2 1/2	3/8	3/8	4 1/8	3/4	1 3/4	9/32	32.0
PTP 3TB184	Q1	18.0	18.4	18.75	16 15/16	13-Arm	3 5/32	2 1/2	3/8	3/8	4 1/8	3/4	1 3/4	9/32	37.8
PTP 3TB200	Q1	19.5	20.0	20.35	18 1/2	13-Arm	3 5/32	2 1/2	3/8	3/8	4 1/8	3/4	1 3/4	9/32	49.9
PTP 3TB250	Q1	24.5	25.0	25.35	23 1/2	13-Arm	3 5/32	2 1/2	3/8	3/8	4 1/8	3/4	1 3/4	9/32	61.0
PTP 3TB300	Q1	29.5	30.0	30.35	28 1/2	13-Arm	3 5/32	2 1/2	3/8	3/8	4 1/8	3/4	1 3/4	9/32	78.5
PTP 3TB380	Q1	37.5	38.0	38.35	36 1/2	13-Arm	3 5/32	2 1/2	3/8	3/8	4 1/8	3/4	1 3/4	9/32	110

GRIPBELT SHEAVES

Browning 4TB Gripbelt Sheaves (with split taper bushings)

For use with all "A" and "B" Section Belts

Specifications - Stock "TB" Sheaves

PART NO.		DIAMETERS				TYPE	4 GROOVES, F=3 1/4"				DIMENSIONS				WEIGHT LESS BUSHING
SHEAVE	BUSHING	DATUM "A"	DATUM "B"	OUTSIDE	INSIDE		OL	L	P	C	H	G	X	E	
PTP 4TB34	P2	3.0"	3.4"	3.75"	2"	3	4 9/16"	2 15/16"	1 1/16"	1 3/8"	3"	5/8"	2 5/16"	1/4	4.5
PTP 4TB36	P2	3.2	3.6	3.95	2 1/16	3	4 9/16	2 15/16	1 1/16	1 3/8	3	5/8	2 5/16	1/4	5.3
PTP 4TB38	P1	3.4	3.8	4.15	2 5/16	5	4 1/8	1 15/16	5/8	1 15/16	3	-	1 5/16	1/4	4.8
PTP 4TB40	P1	3.6	4.0	4.35	2 1/2	5	4 1/8	1 15/16	5/8	1 15/16	3	-	1 5/16	1/4	5.5
PTP 4TB42	P1	3.8	4.2	4.55	2 11/16	5	4 1/8	1 15/16	5/8	1 15/16	3	-	1 5/16	1/4	5.9
PTP 4TB44	P1	4.0	4.4	4.75	2 7/8	13-Web	3 1/2	1 15/16	0	1 5/16	3	5/8	1 5/16	1/4	6.5
PTP 4TB46	P1	4.2	4.6	4.95	3 1/16	13-Web	3 1/2	1 15/16	0	1 5/16	3	5/8	1 5/16	1/4	7.1
PTP 4TB48	P1	4.4	4.8	5.15	3 5/16	13-Web	3 1/2	1 15/16	0	1 5/16	3	5/8	1 5/16	1/4	7.5
PTP 4TB50	P1	4.6	5.0	5.35	3 1/2	13-Web	3 1/2	1 15/16	0	1 5/16	3	5/8	1 5/16	1/4	8.3
PTP 4TB52	P1	4.8	5.2	5.55	3 11/16	13-Web	3 1/2	1 15/16	0	1 5/16	3	5/8	1 5/16	1/4	9.1
PTP 4TB54	P1	5.0	5.4	5.75	3 7/8	13-Web	3 1/2	1 15/16	0	1 5/16	3	5/8	1 5/16	1/4	9.6
PTP 4TB56	P1	5.2	5.6	5.95	4 1/16	13-Web	3 1/2	1 15/16	0	1 5/16	3	5/8	1 5/16	1/4	10.6
PTP 4TB58	P1	5.4	5.8	6.15	4 5/16	13-Web	3 1/2	1 15/16	0	1 5/16	3	5/8	1 5/16	1/4	11.6
PTP 4TB60	P1	5.6	6.0	6.35	4 1/2	13-Web	3 1/2	1 15/16	0	1 5/16	3	5/8	1 5/16	1/4	11.9
PTP 4TB62	P1	5.8	6.2	6.55	4 11/16	13-Web	3 1/2	1 15/16	0	1 5/16	3	5/8	1 5/16	1/4	11.1
PTP 4TB64	P1	6.0	6.4	6.75	4 7/8	13-Web	3 1/2	1 15/16	0	1 5/16	3	5/8	1 5/16	1/4	11.8
PTP 4TB66	P1	6.2	6.6	6.95	5 1/16	13-Web	3 1/2	1 15/16	0	1 5/16	3	5/8	1 5/16	1/4	12.0
PTP 4TB68	P1	6.4	6.8	7.15	5 5/16	13-Web	3 1/2	1 15/16	0	1 5/16	3	5/8	1 5/16	1/4	12.5
PTP 4TB70	Q1	6.6	7.0	7.35	5 1/2	13-Web	3 17/32	2 1/2	0	3/4	4 1/8	3/4	1 3/4	9/32	15.3
PTP 4TB74	Q1	7.0	7.4	7.75	5 15/16	13-Web	3 17/32	2 1/2	0	3/4	4 1/8	3/4	1 3/4	9/32	15.3
PTP 4TB80	Q1	7.6	8.0	8.35	6 1/2	13-Web	3 17/32	2 1/2	0	3/4	4 1/8	3/4	1 3/4	9/32	17.0
PTP 4TB86	Q1	8.2	8.6	8.95	7 1/16	13-Web	3 17/32	2 1/2	0	3/4	4 1/8	3/4	1 3/4	9/32	20.8
PTP 4TB90	Q1	8.6	9.0	9.35	7 1/2	13-Arm	3 17/32	2 1/2	0	3/4	4 1/8	3/4	1 3/4	9/32	20.6
PTP 4TB94	Q1	9.0	9.4	9.75	7 15/16	13-Arm	3 17/32	2 1/2	0	3/4	4 1/8	3/4	1 3/4	9/32	20.1
PTP 4TB110	Q1	10.6	11.0	11.35	9 7/16	13-Arm	3 17/32	2 1/2	0	3/4	4 1/8	3/4	1 3/4	9/32	25.8
PTP 4TB124	Q1	12.0	12.4	12.75	10 15/16	13-Arm	3 17/32	2 1/2	0	3/4	4 1/8	3/4	1 3/4	9/32	27.5
PTP 4TB136	Q1	13.2	13.6	13.95	12 1/16	13-Arm	3 17/32	2 1/2	0	3/4	4 1/8	3/4	1 3/4	9/32	31.5
PTP 4TB154	Q1	15.0	15.4	15.75	13 15/16	13-Arm	3 17/32	2 1/2	0	3/4	4 1/8	3/4	1 3/4	9/32	36.0
PTP 4TB160	Q1	15.6	16.0	16.35	14 1/2	13-Arm	3 17/32	2 1/2	0	3/4	4 1/8	3/4	1 3/4	9/32	39.0
PTP 4TB184	Q1	18.0	18.4	18.75	16 15/16	13-Arm	3 17/32	2 1/2	0	3/4	4 1/8	3/4	1 3/4	9/32	44.8
PTP 4TB200	Q1	19.5	20.0	20.35	18 1/2	13-Arm	3 17/32	2 1/2	0	3/4	4 1/8	3/4	1 3/4	9/32	57.0
PTP 4TB250	Q1	24.5	25.0	25.35	23 1/2	13-Arm	3 17/32	2 1/2	0	3/4	4 1/8	3/4	1 3/4	9/32	69.5
PTP 4TB300	Q1	29.5	30.0	30.35	28 1/2	13-Arm	3 17/32	2 1/2	0	3/4	4 1/8	3/4	1 3/4	9/32	90.8
PTP 4TB380	Q1	37.5	38.0	38.35	36 1/2	13-Arm	3 17/32	2 1/2	0	3/4	4 1/8	3/4	1 3/4	9/32	125

GRIPBELT SHEAVES

Browning 3TC Gripbelt Sheaves (with split taper bushings)

For use with all "C" Section Belts

Specifications - Stock "TC" Sheaves

PART NO.		DIAMETERS			TYPE	3 GROOVES, F=3 1/4" DIMENSIONS								WEIGHT LESS BUSHING
SHEAVE	BUSHING	DATUM "C"	OUTSIDE	INSIDE		OL	L	P	C	H	G	X	E	
PTP 3TC70	Q1	7.0	7.40	5 1/4"	13-Web	3 17/32"	2 1/2	0	3/4	4 1/8	3/4	1 3/4	9/32	16.8
PTP 3TC72	Q1	7.2	7.60	5 7/16	13-Web	3 17/32	2 1/2	0	3/4	4 1/8	3/4	1 3/4	9/32	18.0
PTP 3TC74	Q1	7.4	7.80	5 5/8	13-Web	3 17/32	2 1/2	0	3/4	4 1/8	3/4	1 3/4	9/32	19.1
PTP 3TC76	Q1	7.6	8.00	5 13/16	13-Web	3 17/32	2 1/2	0	3/4	4 1/8	3/4	1 3/4	9/32	21.3
PTP 3TC78	Q1	7.8	8.20	6	13-Web	3 17/32	2 1/2	0	3/4	4 1/8	3/4	1 3/4	9/32	17.4
PTP 3TC80	Q1	8.0	8.40	6 1/4	13-Web	3 17/32	2 1/2	0	3/4	4 1/8	3/4	1 3/4	9/32	17.8
PTP 3TC82	Q1	8.2	8.60	6 7/16	13-Web	3 17/32	2 1/2	0	3/4	4 1/8	3/4	1 3/4	9/32	17.9
PTP 3TC84	Q1	8.4	8.80	6 5/8	13-Web	3 17/32	2 1/2	0	3/4	4 1/8	3/4	1 3/4	9/32	20.4
PTP 3TC86	Q1	8.6	9.00	6 13/16	13-Web	3 17/32	2 1/2	0	3/4	4 1/8	3/4	1 3/4	9/32	19.5
PTP 3TC88	Q1	8.8	9.20	7	13-Web	3 17/32	2 1/2	0	3/4	4 1/8	3/4	1 3/4	9/32	22.5
PTP 3TC90	Q1	9.0	9.40	7 1/4	13-Web	3 17/32	2 1/2	0	3/4	4 1/8	3/4	1 3/4	9/32	20.4
PTP 3TC92	Q1	9.2	9.60	7 7/16	13-Web	3 17/32	2 1/2	0	3/4	4 1/8	3/4	1 3/4	9/32	22.8
PTP 3TC94	Q1	9.4	9.80	7 5/8	13-Arm	3 17/32	2 1/2	0	3/4	4 1/8	3/4	1 3/4	9/32	23.0
PTP 3TC96	Q1	9.6	10.00	7 13/16	13-Arm	3 17/32	2 1/2	0	3/4	4 1/8	3/4	1 3/4	9/32	25.3
PTP 3TC98	Q1	9.8	10.20	8	13-Arm	3 17/32	2 1/2	0	3/4	4 1/8	3/4	1 3/4	9/32	24.4
PTP 3TC100	Q1	10.0	10.40	8 1/4	13-Arm	3 17/32	2 1/2	0	3/4	4 1/8	3/4	1 3/4	9/32	27.6
PTP 3TC102	Q1	10.2	10.60	8 7/16	13-Arm	3 17/32	2 1/2	0	3/4	4 1/8	3/4	1 3/4	9/32	24.9
PTP 3TC106	Q1	10.6	11.0	8 13/16	13-Arm	3 17/32	2 1/2	0	3/4	4 1/8	3/4	1 3/4	9/32	26.9
PTP 3TC110	Q1	11.0	11.40	9 1/4	13-Arm	3 17/32	2 1/2	0	3/4	4 1/8	3/4	1 3/4	9/32	27.4
PTP 3TC114	Q1	11.4	11.80	9 5/8	13-Arm	3 17/32	2 1/2	0	3/4	4 1/8	3/4	1 3/4	9/32	28.3
PTP 3TC120	Q1	12.0	12.40	10 1/4	13-Arm	3 17/32	2 1/2	0	3/4	4 1/8	3/4	1 3/4	9/32	30.3
PTP 3TC130	Q1	13.0	13.40	11 1/4	13-Arm	3 17/32	2 1/2	0	3/4	4 1/8	3/4	1 3/4	9/32	34.9
PTP 3TC160	Q1	16.0	16.40	14 1/4	13-Arm	3 17/32	2 1/2	0	3/4	4 1/8	3/4	1 3/4	9/32	46.0
PTP 3TC200	Q1	20.0	20.40	18 1/4	13-Arm	3 17/32	2 1/2	0	3/4	4 1/8	3/4	1 3/4	9/32	54.5
PTP 3TC240	Q1	24.0	24.40	22 1/4	13-Arm	3 17/32	2 1/2	0	3/4	4 1/8	3/4	1 3/4	9/32	71.0

See Catalogue Section 5 for a full range selection of C Section V-Belts.

BROWNING "358" GRIPBELT DRIVES

More Horsepower in Less Space!

BROWNING "358" GRIPBELT DRIVES combine the improved performance characteristics of today's higher quality synthetic materials with a more compact cross-section to provide an efficient mode of power transmission. Because of the significantly higher capacity of these belts, drives are designed with shorter center distances and smaller sheaves. Overall drive dimensions are reduced by as much as 40%; weight savings of up to 25% are achievable. All material savings are reflected in the lower cost of the drives.

Browning "358" Gripbelt Drives are furnished in only three cross-sections to cover the entire range of drive requirements. This results in a substantial reduction of both belt and sheave inventories.

The belt cross-section approaches a true "V" as shown. The groove walls of the sheaves provide more equalized support to the tension members since there is more side wall contact area. These factors, plus the tougher, more resilient belt materials, provide V-belts with exceptional transmission capacity.



1. The "3V" belt measures $\frac{3}{8}$ " across the top and $\frac{5}{16}$ " in thickness and is available in lengths from 25" through 140".
2. The "5V" belt measures $\frac{5}{8}$ " across the top and $\frac{17}{32}$ " in thickness and is available in lengths from 50" through 255".
3. The "8V" belt measures 1" across the top and $\frac{7}{8}$ " in thickness and is available in lengths from 100" through 450".

"358" Gripbelt Sheaves

BELT SIZE	TYPE		NO. OF GROOVES								
			1	2	3	4	5	6	8	10	12, 14, 16
	Bushing Type	PD Bore	2.6 - 24.95 $\frac{3}{8}$ - 2 $\frac{11}{16}$	2.6 - 24.95 $\frac{3}{8}$ - 2 $\frac{11}{16}$	2.6 - 33.45 $\frac{3}{8}$ - 3 $\frac{3}{4}$	2.6 - 33.45 $\frac{3}{8}$ - 3 $\frac{3}{4}$	4.7 - 33.45 $\frac{1}{2}$ - 3 $\frac{3}{4}$	4.7 - 33.45 $\frac{3}{4}$ - 3 $\frac{3}{4}$	4.7 - 33.45 1 - 4 $\frac{1}{4}$	4.7 - 33.45 1 - 4 $\frac{1}{4}$	
3V	Finished Bore	PD Bore	2.6 - 3.3 $\frac{5}{8}$ - $\frac{7}{8}$	2.6 - 3.3 $\frac{3}{4}$ - 1 $\frac{1}{8}$	2.6 - 3.3 $\frac{7}{8}$ - 1 $\frac{1}{8}$	2.6 - 3.3 $\frac{7}{8}$ - 1 $\frac{3}{8}$					
5V	Bushing Type	PD Bore	4.3 - 27.9 $\frac{1}{2}$ - 2 $\frac{7}{16}$	4.3 - 27.9 $\frac{1}{2}$ - 3 $\frac{3}{4}$	4.3 - 49.9 $\frac{1}{2}$ - 5	4.3 - 49.9 $\frac{1}{2}$ - 5	4.3 - 49.9 $\frac{3}{4}$ - 5	7.0 - 49.9 1 - 5	7.0 - 49.9 1 - 5	7.9 - 49.9 1 $\frac{3}{8}$ - 5	
8V	Bushing Type	PD Bore				12.3 - 63.8 1 $\frac{11}{16}$ - 5	12.3 - 63.8 1 $\frac{11}{16}$ - 5	12.3 - 63.8 1 $\frac{11}{16}$ - 5	12.3 - 63.8 1 $\frac{7}{8}$ - 7 $\frac{1}{16}$	12.3 - 63.8 2 $\frac{3}{8}$ - 7 $\frac{1}{16}$	12.3 - 63.8 2 $\frac{7}{16}$ - 7 $\frac{1}{16}$

Classical and "358" Gripbelt Sheaves are available in either of two bushing types: Split Taper or QD.

Westward Parts has available a full range of Browning 3V, 5V & 8V Drives. Contact your nearest branch for details!

BROWNING STEEL FHP SHEAVES

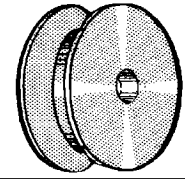

"X" designates items available in shaft size shown.
Please specify bore size when ordering!

AS Series Finished Bore Single Groove Sheaves

For "4L" or "A" Belts

Bar Steel

PART NO.	O.D.	1/2"	5/8"	3/4"	7/8"	1"
PTP AS15	1.50"	X	-	-	-	-
PTP AS17	1.75"	X	X	X	-	-
PTP AS20	2.00"	X	X	X	-	-
PTP AS21	2.10"	X	X	X	-	-
PTP AS22	2.20"	X	X	X	-	-
PTP AS23	2.30"	X	X	X	-	-
PTP AS25	2.50"	X	X	X	X	-
PTP AS26	2.60"	X	X	X	X	-
PTP AS27	2.70"	X	X	X	X	-
PTP AS28	2.80"	X	X	X	X	-
PTP AS30	3.05"	X	X	X	X	X
PTP AS32	3.25"	X	X	X	X	X
PTP AS34	3.45"	X	X	X	X	X

Pressed Steel

PART NO.	O.D.	1/2"	5/8"	3/4"	7/8"	1"
PTP AS39	4.04"	X	X	X	X	X
PTP AS44	4.54"	X	X	X	X	X
PTP AS49	5.04"	X	X	X	X	X
PTP AS54	5.43"	X	X	X	X	X
PTP AS64	6.54"	X	X	X	X	X
PTP AS74	7.54"	X	X	X	-	X
PTP AS84	8.54"	X	X	X	-	X
PTP AS94	9.50"	X	X	X	-	X
PTP AS104	10.50"	X	X	X	-	X
PTP AS114	11.50"	-	X	X	-	X
PTP AS124	12.50"	X	X	X	-	X

BS Series Finished Bore Single & Combination Groove Sheaves

For "4L" or "A" Belts and "5L" or "B" Belts

	PART NO.	O.D.	1/2"	5/8"	3/4"	7/8"	15/16"	1"	1 1/8"	1 3/16"	1 1/4"	1 7/16"
Bar Steel	PTP BS24	2.40"	X	X	X	-	-	-	-	-	-	-
	PTP BS25	2.50"	X	X	X	X	-	-	-	-	-	-
	PTP BS26	2.60"	X	X	X	X	-	-	-	-	-	-
	PTP BS27	2.70"	X	X	X	X	-	-	-	-	-	-
	PTP BS28	2.96"	X	X	X	X	-	X	-	-	-	-
	PTP BS30	3.16"	X	X	X	X	-	X	-	-	-	-
	PTP BS32	3.36"	X	X	X	X	-	X	-	-	-	-
Pressed Steel	PTP BS34	3.57"	X	X	X	-	-	-	-	-	-	-
	PTP BS36	3.77"	X	X	X	-	-	-	-	-	-	-
	PTP BS40	3.97"	X	X	X	X	-	X	-	-	-	-

BROWNING CAST IRON FHP SHEAVES

Combination Groove for "3L", "4L" or "A" Belts

NOTE: All AKH and 2AKH Sheaves use "H" Bushings

BK-HS Series Bushing Type Single Groove Sheaves

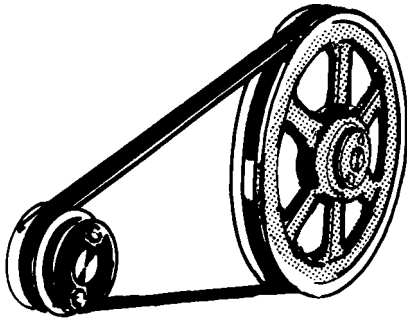

PART NO.	O.D.
PTP AK30H	3.05"
PTP AK32H	3.25"
PTP AK34H	3.45"
PTP AK39H	3.75"
PTP AK41H	3.95"
PTP AK44H	4.25"
PTP AK46H	4.45"
PTP AK49H	4.75"
PTP AK51H	4.95"
PTP AK54H	5.25"
PTP AK56H	5.45"
PTP AK59H	5.75"
PTP AK61H	5.95"
PTP AK64H	6.25"
PTP AK66H	6.45"
PTP AK69H	6.75"

PART NO.	O.D.
PTP AK71H	6.95"
PTP AK74H	7.25"
PTP AK79H	7.75"
PTP AK84H	8.25"
PTP AK89H	8.75"
PTP AK94H	9.25"
PTP AK99H	9.75"
PTP AK104H	10.25"
PTP AK109H	10.75"
PTP AK114H	11.25"
PTP AK124H	12.25"
PTP AK134H	13.25"
PTP AK144H	14.25"
PTP AK154H	15.25"
PTP AK184H	18.25"

2AKH Series Bushing Type Two Groove Sheaves

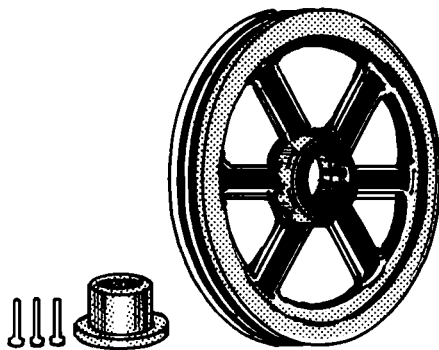

PART NO.	O.D.
PTP 2AK30H	3.05"
PTP 2AK32H	3.25"
PTP 2AK34H	3.45"
PTP 2AK39H	3.75"
PTP 2AK41H	3.95"
PTP 2AK44H	4.25"
PTP 2AK46H	4.45"
PTP 2AK49H	4.75"
PTP 2AK51H	4.95"
PTP 2AK54H	5.25"
PTP 2AK56H	5.45"
PTP 2AK59H	5.75"

PART NO.	O.D.
PTP 2AK61H	5.95"
PTP 2AK64H	6.25"
PTP 2AK74H	7.25"
PTP 2AK84H	8.25"
PTP 2AK94H	9.25"
PTP 2AK104H	10.25"
PTP 2AK114H	11.25"
PTP 2AK124H	12.25"
PTP 2AK134H	13.25"
PTP 2AK144H	14.25"
PTP 2AK154H	15.25"
PTP 2AK154H	18.25"

EASY TO MOUNT • CLAMP FIT ON SHAFT • EASY TO REMOVE

BROWNING CAST IRON FHP SHEAVES

Combination Groove for "4L" or "A" Belts and "5L" or "B" Belts
NOTE: All BK-H and 2BK-H Sheaves use "H" Bushings

BKH Series Bushing Type Single Groove Sheaves

792 Stock "BKH" Combinations

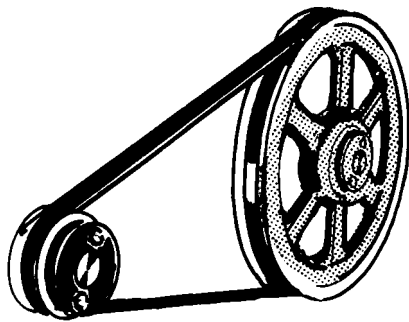

PART NO.	O.D.
PTP BK30H	3.15"
PTP BK32H	3.35"
PTP BK34H	3.55"
PTP BK36H	3.75"
PTP BK40H	3.95"
PTP BK45H	4.25"
PTP BK47H	4.45"
PTP BK50H	4.75"
PTP BK52H	4.95"
PTP BK55H	5.25"
PTP BK57H	5.45"
PTP BK60H	5.75"
PTP BK62H	5.95"
PTP BK65H	6.25"
PTP BK67H	6.45"
PTP BK70H	6.75"
PTP BK72H	6.95"

PART NO.	O.D.
PTP BK75H	7.25"
PTP BK77H	7.45"
PTP BK80H	7.75"
PTP BK85H	8.25"
PTP BK90H	8.75"
PTP BK95H	9.25"
PTP BK100H	9.95"
PTP BK105H	10.25"
PTP BK110H	10.75"
PTP BK115H	11.25"
PTP BK120H	11.75"
PTP BK130H	12.75"
PTP BK140H	13.75"
PTP BK150H	14.75"
PTP BK160H	15.75"
PTP BK190H	18.75"

2BKH Series Bushing Type Two Groove Sheaves

576 Stock "2BKH" Combinations

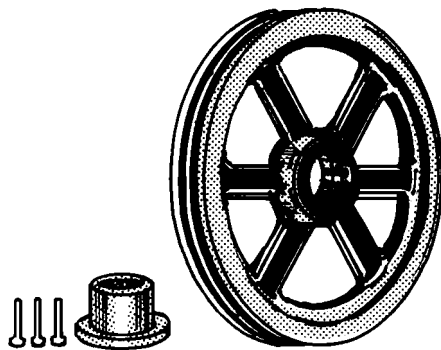

PART NO.	O.D.
PTP 2BK32H	3.35"
PTP 2BK34H	3.55"
PTP 2BK36H	3.75"
PTP 2BK40H	3.95"
PTP 2BK45H	4.25"
PTP 2BK47H	4.45"
PTP 2BK50H	4.75"
PTP 2BK52H	4.95"
PTP 2BK55H	5.25"
PTP 2BK57H	5.45"
PTP 2BK60H	5.75"
PTP 2BK62H	5.95"

PART NO.	O.D.
PTP 2BK65H	6.25"
PTP 2BK67H	6.45"
PTP 2BK70H	6.75"
PTP 2BK80H	7.75"
PTP 2BK90H	8.75"
PTP 2BK100H	9.75"
PTP 2BK110H	10.75"
PTP 2BK120H	11.75"
PTP 2BK130H	12.75"
PTP 2BK140H	13.75"
PTP 2BK160H	15.75"
PTP 2BK190H	18.75"

EASY TO MOUNT • CLAMP FIT ON SHAFT • EASY TO REMOVE

CAST IRON SHEAVES

For "4L" or "A" and "5L" or "B" Belts
Hollow Head Setscrews • Statically Balanced

BK-S Series Finished Bore Single and Combination Groove Sheaves

PART NO.	O.D.	1/2"	5/8"	3/4"	7/8"	15/16"	1"	1 1/8"
PTP BK24S	2.40"	X	X	X	-	-	-	-
PTP BK25S	2.50"	X	X	X	X	-	-	-
PTP BK26S	2.60"	X	X	X	X	-	-	-
PTP BK27S	2.70"	X	X	X	X	-	-	-
PTP BK28S	2.95"	X	X	X	X	-	-	-
PTP BK30S	3.15"	X	X	X	X	-	-	-
PTP BK32S	3.35"	X	X	X	X	-	-	-
PTP BK34S	3.55"	X	X	X	X	-	X	X
PTP BK40S	3.95"	X	X	X	X	-	X	X

Note: X designates items available in shaft size shown.
Please specify bore size when ordering (ie. order as PTP BK24-5/8S)

BROWNING CAST IRON FHP SHEAVES

For "4L" or "A" and "5L" or "B" Belts
Hollow Head Setscrews • Statically Balanced

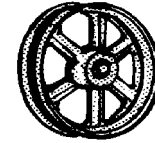

BK Series Finished Bore Single and Combination Groove Sheaves

PART NO.	O.D.	1/2"	5/8"	3/4"	7/8"	15/16"	1"	1 1/8"	1 3/16"	1 1/4"	1 7/16"	1 3/8"
PTP BK24	2.40"	X	X	X	-	-	-	-	-	-	-	-
PTP BK25	2.50"	X	X	X	X	-	-	-	-	-	-	-
PTP BK26	2.60"	X	X	X	X	-	-	-	-	-	-	-
PTP BK27	2.70"	X	X	X	X	-	-	-	-	-	-	-
PTP BK28	2.95"	X	X	X	X	-	-	-	-	-	-	-
PTP BK30	3.15"	X	X	X	X	-	-	-	-	-	-	-
PTP BK32	3.35"	X	X	X	X	-	-	-	-	-	-	-
PTP BK34	3.55"	X	X	X	X	-	X	X	-	-	-	-
PTP BK36	3.75"	X	X	X	X	-	X	X	-	-	-	-
PTP BK40	3.95"	X	X	X	X	-	X	X	-	-	-	-
PTP BK45	4.25"	X	X	X	X	-	X	X	-	-	-	-
PTP BK47	4.45"	X	X	X	X	-	X	X	-	-	-	-
PTP BK50	4.75"	X	X	X	X	X	X	X	-	-	-	-
PTP BK52	4.95"	X	X	X	X	-	X	X	X	-	-	-
PTP BK55	5.25"	X	X	X	X	-	X	X	X	-	-	-
PTP BK57	5.45"	-	X	X	X	X	X	X	-	-	-	-
PTP BK60	5.75"	X	X	X	X	-	X	X	X	-	-	-
PTP BK62	5.95"	X	X	X	X	X	X	X	X	-	-	-
PTP BK65	6.25"	-	X	X	-	-	X	X	-	-	-	-
PTP BK67	6.45"	-	X	X	-	-	X	X	-	-	-	-
PTP BK70	6.75"	-	X	X	-	X	X	X	X	-	X	-
PTP BK72	6.95"	-	-	X	-	-	X	X	-	-	-	X
PTP BK75	7.25"	-	-	X	-	-	X	X	-	-	-	X
PTP BK77	7.45"	-	-	X	-	-	X	X	-	-	-	X
PTP BK80	7.75"	-	X	X	X	-	X	X	X	X	X	X
PTP BK85	8.25"	-	-	X	-	-	X	X	-	-	X	X
PTP BK90	8.75"	-	-	X	X	X	X	X	X	X	X	X
PTP BK95	9.25"	-	-	X	-	-	X	X	-	-	X	X
PTP BK100	9.75"	-	-	X	X	X	X	X	X	X	X	X
PTP BK105	10.25"	-	-	-	-	-	X	-	-	-	X	X
PTP BK110	10.75"	-	-	X	-	-	X	X	X	-	X	X
PTP BK115	11.25"	-	-	-	-	-	X	-	-	-	X	X
PTP BK120	11.75"	-	-	X	-	-	X	-	X	-	X	X
PTP BK130	12.75"	-	-	X	-	-	X	X	X	X	X	-
PTP BK140	13.75"	-	-	X	-	-	X	-	X	-	X	-
PTP BK160	15.75"	-	-	-	-	-	X	X	X	X	X	-
PTP BK190	18.75"	-	-	-	-	-	X	-	X	X	X	-

Note: X designates items available in shaft size shown.
Please specify bore size when ordering.

BROWNING CAST IRON FHP SHEAVES

Combination Groove for "4L" or "A" Belts and "5L" or "B" Belts

NOTE: All BK-H and 2BK-H use "H" Bushings

• Individually Packaged •

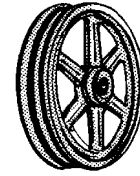

BKH Series Bushing Type Single Groove Sheaves

PART NO.	O.D.	1/2"	5/8"	3/4"	7/8"	1"	1 1/8"	1 3/16"	1 3/8"	1 7/16"
PTP 2BK25	2.50"	X	X	X	X	-	-	-	-	-
PTP 2BK27	2.70"	X	X	X	X	X	-	-	-	-
PTP 2BK28	2.95"	X	X	X	X	X	X	-	-	-
PTP 2BK30	3.15"	X	X	X	X	X	X	-	-	-
PTP 2BK32	3.35"	-	X	-	X	X	X	-	-	-
PTP 2BK34	3.55"	-	X	X	X	X	X	-	-	-
PTP 2BK36	3.75"	-	-	X	X	X	X	-	X	-
PTP 2BK40	3.95"	-	X	X	X	X	X	-	-	-
PTP 2BK45	4.25"	-	-	-	-	X	X	-	X	-
PTP 2BK47	4.45"	-	-	-	X	X	X	-	-	-
PTP 2BK50	4.75"	-	-	X	-	X	X	-	X	-
PTP 2BK52	4.95"	-	-	-	X	X	X	-	X	-
PTP 2BK55	5.25"	-	-	-	-	X	X	-	X	-
PTP 2BK57	5.45"	-	-	-	-	X	X	-	X	-
PTP 2BK60	5.75"	-	-	X	X	X	X	-	X	-
PTP 2BK62	5.95"	-	-	-	-	X	X	-	X	-
PTP 2BK65	6.25"	-	-	-	-	X	X	-	X	-
PTP 2BK67	6.45"	-	-	-	-	X	X	-	X	-
PTP 2BK70	6.75"	-	-	X	-	X	X	X	X	X
PTP 2BK80	7.75"	-	-	X	-	X	X	X	X	X
PTP 2BK90	8.75"	-	-	X	-	X	X	X	X	X
PTP 2BK100	9.75"	-	-	X	-	X	-	X	X	X
PTP 2BK110	10.75"	-	-	-	-	X	-	X	-	X
PTP 2BK120	11.75"	-	-	-	-	X	-	X	-	X

NOTE: X designates items available in shaft size shown.

Please specify bore size when ordering.

Try matching our Browning sheaves with our Goodyear belts shown in Section 5

CAST IRON SHEAVES

Combination Groove for "4L" or "A" Belts and "5L" or "B" Belts
NOTE: All BK-HS and 2BK-HS Sheaves use "H" Bushings

BK-HS Series Bushing Type Single Groove Sheaves



PART NO.	O.D.
PTP BK30HS	3.15"
PTP BK32HS	3.35"
PTP BK34HS	3.55"
PTP BK36HS	3.75"
PTP BK40HS	3.95"
PTP BK45HS	4.25"
PTP BK47HS	4.45"
PTP BK50HS	4.75"
PTP BK52HS	4.95"
PTP BK55HS	5.25"
PTP BK57HS	5.45"
PTP BK60HS	5.75"
PTP BK62HS	5.95"
PTP BK65HS	6.25"
PTP BK67HS	6.45"
PTP BK70HS	6.75"
PTP BK72HS	6.95"

PART NO.	O.D.
PTP BK75HS	7.25"
PTP BK77HS	7.45"
PTP BK80HS	7.75"
PTP BK85HS	8.25"
PTP BK90HS	8.75"
PTP BK95HS	9.25"
PTP BK100HS	9.95"
PTP BK105HS	10.25"
PTP BK110HS	10.75"
PTP BK115HS	11.25"
PTP BK120HS	11.75"
PTP BK130HS	12.75"
PTP BK140HS	13.75"
PTP BK150HS	14.75"
PTP BK160HS	15.75"
PTP BK190HS	18.75"

2BK-HS Series Bushing Type Two Groove Sheaves



PART NO.	O.D.
PTP 2BK32HS	3.35"
PTP 2BK34HS	3.55"
PTP 2BK36HS	3.75"
PTP 2BK40HS	3.95"
PTP 2BK45HS	4.25"
PTP 2BK47HS	4.45"
PTP 2BK50HS	4.75"
PTP 2BK52HS	4.95"
PTP 2BK55HS	5.25"
PTP 2BK57HS	5.45"
PTP 2BK60HS	5.75"
PTP 2BK62HS	5.95"

PART NO.	O.D.
PTP 2BK65HS	6.25"
PTP 2BK67HS	6.45"
PTP 2BK70HS	6.75"
PTP 2BK80HS	7.75"
PTP 2BK90HS	8.75"
PTP 2BK100HS	9.75"
PTP 2BK110HS	10.75"
PTP 2BK120HS	11.75"
PTP 2BK130HS	12.75"
PTP 2BK140HS	13.75"
PTP 2BK160HS	15.75"
PTP 2BK190HS	18.75"

Precision Quality at an Economical Cost

LIGHT DUTY BUSH TYPE SHEAVES

MBL & 2MBL (A-B & 4L - 5L V-Belts) - 1 Groove

PART NO.	A (4L) BELTS	B (5L) BELTS	O.D.	TYPE	E	F	L	M	WEIGHT (LBS.)
PTP MBL31	2.4	2.8	3.1	1B	1/2	7/8	1 1/4	7/8	1.3
PTP MBL33	2.6	3.0	3.3	1B	1/2	7/8	1 1/4	7/8	1.4
PTP MBL35	2.8	3.2	3.5	1B	1/2	7/8	1 1/4	7/8	1.6
PTP MBL37	3.0	3.4	3.7	1B	1/16	7/8	1 1/4	7/16	1.4
PTP MBL39	3.2	3.6	3.9	1B	1/16	7/8	1 1/4	7/16	1.7
PTP MBL42	3.5	3.9	4.2	1B	1/16	7/8	1 1/4	7/16	2.0
PTP MBL44	3.7	4.1	4.4	1B	1/16	7/8	1 1/4	7/16	2.4
PTP MBL47	4.0	4.4	4.7	3W	1/16	7/8	1 1/4	7/16	2.0
PTP MBL49	4.2	4.6	4.9	3W	1/16	7/8	1 1/4	7/16	2.4
PTP MBL52	4.5	4.9	5.2	3W	1/16	7/8	1 1/4	7/16	2.4
PTP MBL54	4.7	5.1	5.4	3W	1/16	7/8	1 1/4	7/16	2.9
PTP MBL57	5.0	5.4	5.7	5A	1/16	7/8	1 1/4	7/16	2.2
PTP MBL59	5.2	5.6	5.9	5A	1/16	7/8	1 1/4	7/16	2.7
PTP MBL62	5.5	5.9	6.2	5A	1/16	7/8	1 1/4	7/16	2.7
PTP MBL64	5.7	6.1	6.4	5A	1/16	7/8	1 1/4	7/16	3.1
PTP MBL67	6.0	6.4	6.7	5A	1/8	7/8	1 1/4	1/2	2.8
PTP MBL69	6.2	6.6	6.9	5A	1/8	7/8	1 1/4	1/2	3.6
PTP MBL72	6.5	6.9	7.2	5A	1/8	7/8	1 1/4	1/2	3.4
PTP MBL74	6.7	7.1	7.4	5A	1/8	7/8	1 1/4	1/2	3.6
PTP MBL77	7.0	7.4	7.7	5A	1/8	7/8	1 1/4	1/2	3.8
PTP MBL82	7.5	7.9	8.2	5A	1/8	7/8	1 1/4	1/2	3.8
PTP MBL87	8.0	8.4	8.7	5A	1/8	7/8	1 1/4	1/2	5.1
PTP MBL92	8.5	8.9	9.2	5A	1/8	7/8	1 1/4	1/2	5.3
PTP MBL97	9.0	9.4	9.7	5A	1/8	7/8	1 1/4	1/2	5.8
PTP MBL102	9.5	9.9	10.2	5A	1/8	7/8	1 1/4	1/2	5.5
PTP MBL107	10.0	10.4	10.7	5A	1/8	7/8	1 1/4	1/2	5.8
PTP MBL112	10.5	10.9	11.2	5A	1/8	7/8	1 1/4	1/2	7.2
PTP MBL117	11.0	11.4	11.7	5A	1/8	7/8	1 1/4	1/2	6.9
PTP MBL127	12.0	12.4	12.7	5A	1/8	7/8	1 1/4	1/2	7.9
PTP MBL137	13.0	13.4	13.7	5A	1/8	7/8	1 1/4	1/2	10.2
PTP MBL147	14.0	14.4	14.7	5A	1/8	7/8	1 1/4	1/2	13.2
PTP MBL157	15.0	15.4	15.7	5A	1/8	7/8	1 1/4	1/2	16.1
PTP MBL187	18.0	18.4	18.7	5A	1/8	7/8	1 1/4	1/2	12.5

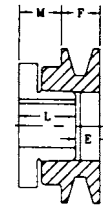
MASKA

TYPE 1

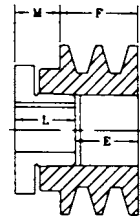

TYPE 2

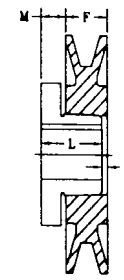

TYPE 3

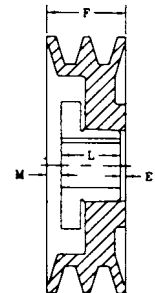

TYPE 4

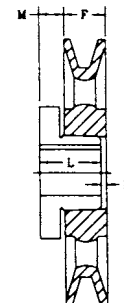

TYPE 5

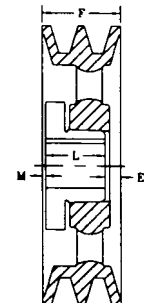

TYPE 6

"E", "F", "L" and "M" sheave dimensions vary according to shaft tolerance.

MBL Series use "H" bushing.

Suffix on type indicates construction: A=arm, B=block, W=web

CAUTION: DO NOT use these gray cast iron sheaves with rim speeds in excess of 6,500 feet per minute.

LIGHT DUTY FIXED BORE SHEAVES

MBL & 2MBL (A-B & 4L-5L V-Belts) - 2 Grooves

PART NO.	A (4L) BELTS	B (5L) BELTS	O.D.	TYPE	E	F	L	M	WEIGHT (LBS.)
PTP 2MBL33	2.6	3.0	3.3	2B	1 3/8	1 3/4	1 1/4	7/8	2.3
PTP 2MBL35	2.8	3.2	3.5	2B	1 3/8	1 3/4	1 1/4	7/8	2.5
PTP 2MBL37	3.0	3.4	3.7	2B	15/16	1 3/4	1 1/4	7/8	3.0
PTP 2MBL39	3.2	3.6	3.9	2B	15/16	1 3/4	1 1/4	7/16	2.7
PTP 2MBL42	3.5	3.9	4.2	2B	15/16	1 3/4	1 1/4	7/16	3.3
PTP 2MBL44	3.7	4.1	4.4	2B	15/16	1 3/4	1 1/4	7/16	3.3
PTP 2MBL47	4.0	4.4	4.7	4W	15/16	1 3/4	1 1/4	7/16	3.8
PTP 2MBL49	4.2	4.6	4.9	4W	15/16	1 3/4	1 1/4	7/16	4.0
PTP 2MBL52	4.5	4.9	5.2	4W	15/16	1 3/4	1 1/4	7/16	4.4
PTP 2MBL54	4.7	5.1	5.4	4W	15/16	1 3/4	1 1/4	7/16	4.4
PTP 2MBL57	5.0	5.4	5.7	4W	15/16	1 3/4	1 1/4	7/16	4.8
PTP 2MBL59	5.2	5.6	5.9	4W	15/16	1 3/4	1 1/4	7/16	5.8
PTP 2MBL62	5.5	5.9	6.2	6A	11/16	1 3/4	1 1/4	3/16	5.3
PTP 2MBL64	5.7	6.1	6.4	6A	11/16	1 3/4	1 1/4	3/16	5.9
PTP 2MBL67	6.0	6.4	6.7	6A	11/16	1 3/4	1 1/4	3/16	5.2
PTP 2MBL69	6.2	6.6	6.9	6A	11/16	1 3/4	1 1/4	3/16	6.5
PTP 2MBL77	7.0	7.4	7.7	6A	11/16	1 3/4	1 1/4	3/16	6.8
PTP 2MBL87	8.0	8.4	8.7	6A	11/16	1 3/4	1 1/4	3/16	9.6
PTP 2MBL87	9.0	9.4	9.7	6A	11/16	1 3/4	1 1/4	3/16	9.2
PTP 2MBL107	10.0	10.4	10.7	6A	11/16	1 3/4	1 1/4	3/16	12.6
PTP 2MBL117	11.0	11.4	11.7	6A	11/16	1 3/4	1 1/4	3/16	14.3
PTP 2MBL127	12.0	12.4	12.7	6A	11/16	1 3/4	1 1/4	3/16	14.1
PTP 2MBL137	13.0	13.4	13.7	6A	11/16	1 3/4	1 1/4	3/16	14.9
PTP 2MBL157	15.0	15.4	15.7	6A	11/16	1 3/4	1 1/4	3/16	18.1
PTP 2MBL187	18.0	18.4	18.7	6A	11/16	1 3/4	1 1/4	3/16	22.1

MASKA

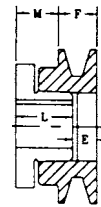

TYPE 1

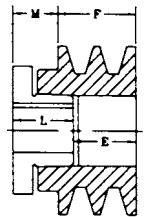

TYPE 2

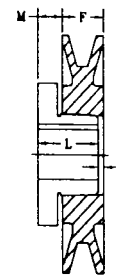

TYPE 3

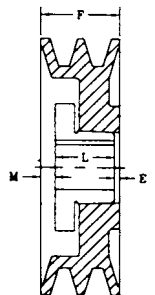

TYPE 4

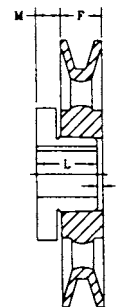

TYPE 5

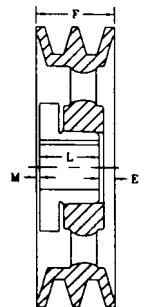

TYPE 6

"E", "F", "L" and "M" sheave dimensions vary according to shaft tolerance.

MBL Series use "H" bushing.

Suffix on type indicates construction: A=arm, B=block, W=web

CAUTION: DO NOT use these gray cast iron sheaves with rim speeds in excess of 6,500 feet per minute.

LIGHT DUTY FIXED BORE SHEAVES

1 Groove

PART NO.	D.D. B BELTS	O.D.	TYPE	L	STANDARD BORE	MAX. BORE	WEIGHT (LBS.)
PTP MB20	1.7	2.0	5B	1 1/2	1/2 - 5/8 - 3/4	3/4	0.5
PTP MB23	2.0	2.3	5B	1 1/2	1/2 - 5/8 - 3/4 - 7/8	7/8	1.0
PTP MB25	2.2	2.5	5B	1 1/2	1/2 - 5/8 - 3/4 - 7/8 - 1 1/8	1	1.0
PTP MB26	2.3	2.6	5B	1 1/2	1/2 - 5/8 - 3/4 - 7/8 - 1	1	1.0
PTP MB28	2.5	2.8	6B	1 3/8	1/2 - 5/8 - 3/4 - 7/8 - 1 1/8	1 1/8	1.0
PTP MB30	2.7	3.0	6B	1 3/8	1/2 - 5/8 - 3/4 - 7/8 - 1 1/8	1 1/8	1.0
PTP MB31	2.8	3.1	6B	1 3/8	1/2 - 5/8 - 3/4 - 7/8 - 1 1/8	1 1/8	1.0
PTP MB33	2.9	3.3	6B	1 3/8	1/2 - 5/8 - 3/4 - 7/8 - 1 1/8	1 1/8	1.0
PTP MB34	3.0	3.4	6B	1 3/8	1/2 - 5/8 - 3/4 - 7/8 - 1 1/8	1 1/8	1.0
PTP MB35	3.2	3.5	6B	1 3/8	1/2 - 5/8 - 3/4 - 7/8 - 1 1/8	1 1/8	1.5
PTP MB38	3.5	3.8	6B	1 1/4	1/2 - 5/8 - 3/4 - 7/8 - 1 1/8	1 1/8	1.5
PTP MB40	3.7	4.0	6B	1 1/4	1/2 - 5/8 - 3/4 - 7/8 - 1 1/8	1 1/4	2.0
PTP MB45	4.2	4.5	6W	1 1/4	1/2 - 5/8 - 3/4 - 7/8 - 1 1/8	1 1/4	2.0
PTP MB50	4.7	5.0	5W	1 1/2	1/2 - 5/8 - 3/4 - 7/8 - 1 1/8 - 1 3/16	1 1/4	2.5
PTP MB55	5.2	5.5	5A	1 1/2	1/2 - 5/8 - 3/4 - 7/8 - 1 1/8 - 1 3/16	1 1/4	2.5
PTP MB60	5.7	6.0	5A	1 1/2	1/2 - 5/8 - 3/4 - 7/8 - 1 1/8 - 1 3/16	1 1/4	2.5
PTP MB65	6.2	6.5	5A	1 1/2	1/2 - 5/8 - 3/4 - 7/8 - 1 1/8 - 1 3/16	1 1/4	3.0
PTP MB68	6.4	6.8	5A	1 1/2	1/2 - 5/8 - 3/4 - 7/8 - 1 1/8 - 1 3/16	1 1/4	4.0
PTP MB70	6.7	7.0	5A	1 1/2	1/2 - 5/8 - 3/4 - 7/8 - 1 1/8 - 1 3/16	1 1/4	3.5
PTP MB75	7.2	7.5	5A	1 1/2	1/2 - 5/8 - 3/4 - 7/8 - 1 1/8 - 1 3/16	1 1/4	4.0
PTP MB78	7.4	7.8	5A	1 1/2	1/2 - 5/8 - 3/4 - 7/8 - 1 1/8 - 1 3/16	1 1/4	4.0
PTP MB80	7.7	8.0	5A	1 1/2	1/2 - 5/8 - 3/4 - 7/8 - 1 1/8 - 1 3/16	1 1/4	4.0
PTP MB90	8.7	9.0	5A	1 1/2	1/2 - 5/8 - 3/4 - 7/8 - 1 1/8 - 1 3/16	1 1/4	5.0
PTP MB100	9.7	10.0	5A	1 1/2	1/2 - 5/8 - 3/4 - 7/8 - 1 1/8 - 1 3/16	1 1/4	6.0
PTP MB110	10.7	11.0	5A	1 1/2	1/2 - 5/8 - 3/4 - 7/8 - 1 1/8 - 1 3/16	1 1/4	7.0
PTP MB120	11.7	12.0	5A	1 1/2	1/2 - 5/8 - 3/4 - 7/8 - 1 1/8 - 1 3/16	1 1/4	8.0

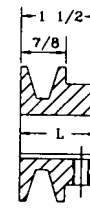
MASKA

Type 5

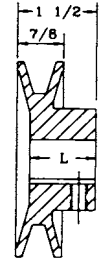

Type 6

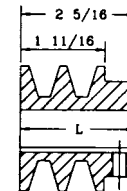

Type 7

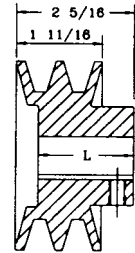

Type 8

Be sure to specify bore size when ordering (i.e. PTP MB40-5/8)

Suffix on type indicates construction: A=arm, B=block, W=web

CAUTION: DO NOT use these gray cast iron sheaves with rim speeds in excess of 6,500 feet per minute.

LIGHT DUTY FIXED BORE SHEAVES

MB & 2MB (A & B, 4L & 5L Belts) - 1 Groove

PART NO.	D.D. B BELTS	O.D.	TYPE	L	STANDARD BORE	MAX. BORE	WEIGHT (LBS.)
PTP 2MB20	1.7	2.0	7B	2 5/16	1/2 - 5/8 - 3/4	3/4	1.0
PTP 2MB23	2.0	2.3	7B	2 5/16	1/2 - 5/8 - 3/4 - 7/8	7/8	1.0
PTP 2MB25	2.2	2.5	7B	2 5/16	1/2 - 5/8 - 3/4 - 7/8 - 1 1/8	1	1.5
PTP 2MB28	2.5	2.8	8B	1 5/16	1/2 - 5/8 - 3/4 - 7/8 - 1 1/8	1 1/8	1.5
PTP 2MB30	2.7	3.0	8B	1 5/16	1/2 - 5/8 - 3/4 - 7/8 - 1 1/8	1 1/8	2.0
PTP 2MB33	2.9	3.3	8B	1 7/8	1/2 - 5/8 - 3/4 - 7/8 - 1 1/8	1 1/8	2.0
PTP 2MB35	3.2	3.5	8B	1 7/8	1/2 - 5/8 - 3/4 - 7/8 - 1 1/8	1 1/8	2.5
PTP 2MB38	3.5	3.8	8B	1 7/8	1/2 - 5/8 - 3/4 - 7/8 - 1 1/8	1 1/8	3.0
PTP 2MB40	3.7	4.0	8B	1 11/16	1/2 - 5/8 - 3/4 - 7/8 - 1 1/8	1 1/4	3.0
PTP 2MB45	4.2	4.5	8W	1 13/16	1/2 - 5/8 - 3/4 - 7/8 - 1 1/8	1 1/4	4.0
PTP 2MB50	4.7	5.0	8W	1 13/16	1/2 - 5/8 - 3/4 - 7/8 - 1 1/8	1 1/4	4.5
PTP 2MB55	5.2	5.5	8W	1 13/16	1/2 - 5/8 - 3/4 - 7/8 - 1 1/8	1 1/4	5.0
PTP 2MB60	5.7	6.0	8W	1 13/16	1/2 - 5/8 - 3/4 - 7/8 - 1 1/8	1 1/4	6.0
PTP 2MB65	6.2	6.5	8A	1 13/16	1/2 - 5/8 - 3/4 - 7/8 - 1 1/8	1 1/4	6.0
PTP 2MB70	6.7	7.0	8A	1 13/16	1/2 - 5/8 - 3/4 - 7/8 - 1 1/8	1 1/4	6.0
PTP 2MB80	7.7	8.0	8A	1 13/16	1/2 - 5/8 - 3/4 - 7/8 - 1 1/8	1 1/4	8.0
PTP 2MB90	8.7	9.0	8A	1 13/16	1/2 - 5/8 - 3/4 - 7/8 - 1 1/8	1 1/4	9.0
PTP 2MB100	9.7	10.0	8A	1 13/16	1/2 - 5/8 - 3/4 - 7/8 - 1 1/8	1 1/4	9.0
PTP 2MB110	10.7	11.0	8A	1 13/16	1/2 - 5/8 - 3/4 - 7/8 - 1 1/8	1 1/4	10.0
PTP 2MB120	11.7	12.0	8A	1 13/16	1/2 - 5/8 - 3/4 - 7/8 - 1 1/8	1 1/4	10.0



Type 5

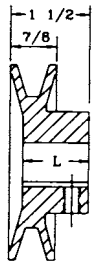

Type 6

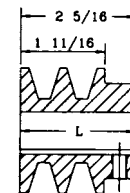

Type 7

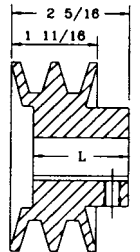

Type 8

Be sure to specify bore size when ordering (i.e. PTP MB40-5/8)

Suffix on type indicates construction: A=arm, B=block, W=web

CAUTION: DO NOT use these gray cast iron sheaves with rim speeds in excess of 6,500 feet per minute.

SNUGULATOR TIGHTENERS FOR ROLLER CHAINS

SNUGULATOR®
TIGHTENERS

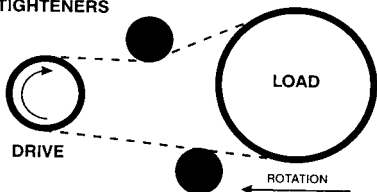

Using the Snugulator in the above application will make your roller chain last longer and run cooler and quieter.

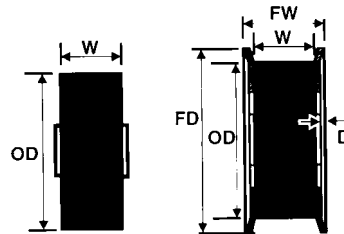

- Long lasting
- Quiet
- Increases chain life
- Performs smoothly on both worn and new chain
- Superior replacement for all types of equipment
- Snugulators may also be used for belt application utilizing the same guidelines
- Snugulator Tighteners will work in most gear box oil

If your application is in a load bearing area, a wrap of more than 25 degrees, surging of chains or close to the sprocket use the IdleMaster Tightener. For more information refer to the Snugulator and IdleMaster Problem Solving Handbook.

Plain with Bolt Hole

Perfect for belts and roller chains with short runs where a bolt can be used as a mounting device. Choose a tightener that will protrude a minimum of 1/8" beyond each side of the chain.

PART NO.	ROLLER CHAIN SIZE	BOLT HOLE MOUNTING SIZE	W	OD	D
PTP 2500BD3	100 Pitch and smaller	1/2" - 5/8" - 3/4"	2 1/8"	3 1/2"	1/8" one side
PTP 2550BE3	80 Pitch and smaller	1/2" - 5/8" - 3/4"	1 3/8"	3 1/2"	1/8" one side
PTP 2755CB2	60 Pitch and smaller	3/8" - 1/2" - 5/8"	1"	2 3/4"	1/16" both sides

Flanged with Bolt Hole

Use where a bolt is needed for mounting. Choose this design when durable steel-flanged edges are needed to hold longer belts and chains in place.

PART NO.	ROLLER CHAIN SIZE	BOLT HOLE MOUNTING SIZE	W	OD	D	FD	FW
PTP 2500FBD3	100 Pitch and smaller	1/2" - 5/8" - 3/4"	2 1/8"	3 1/2"	1/16"	4"	2 1/2"
PTP 2550FBE3	80 Pitch and smaller	1/2" - 5/8" - 3/4"	1 3/8"	3 1/2"	1/16"	4"	1 3/4"
PTP 2755FCB2	60 Pitch and smaller	3/8" - 1/2" - 5/8"	1"	2 3/4"	1/8"	3 1/4"	1 5/16"

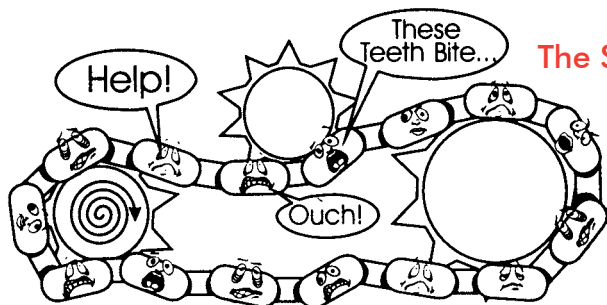

The Snuggler Difference

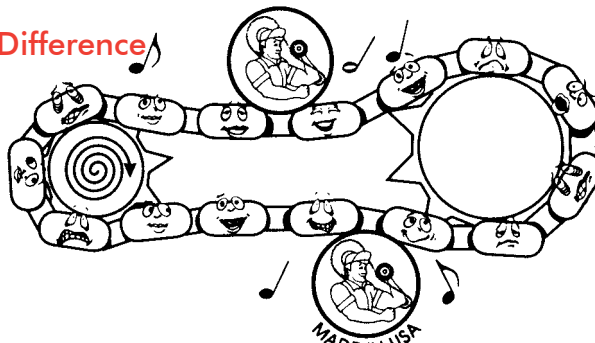

See & Hear the Difference!

IDLEMASTER TIGHTENERS FOR ROLLER CHAINS AND BELTS

Designed for Complete Interchangability!

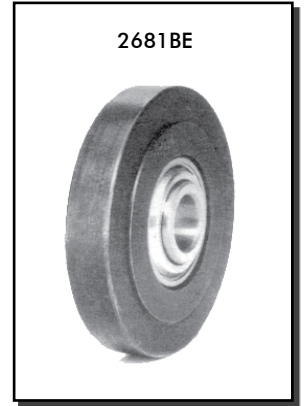
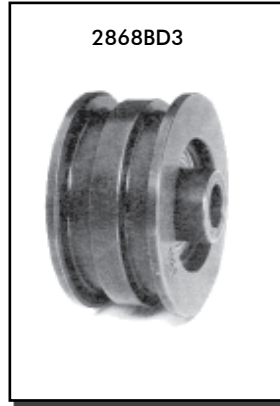
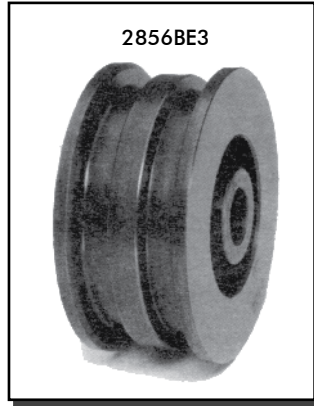
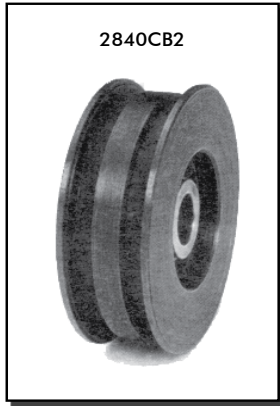

PART NO.	DESCRIPTION	A	B	C	D	E	F	G	H	I	J	K
PTP 2840CB2	40 Pitch	0.850	0.100	0.650	0.300	0.175	0.100	0.200	2.700	1/16	5/8 - 1/2 - 3/8	0.937
PTP 2856BE3	50 & 60 Pitch	1.550	0.200	1.150	0.370	0.390	0.187	0.294	3.450	1/32	1/2 - 5/8 - 3/4	1.130
PTP 2868BD3	60 & 80 Pitch	1.750	0.200	1.349	0.489	0.430	0.187	0.294	3.450	1/5	1/2 - 5/8 - 3/4	1.130

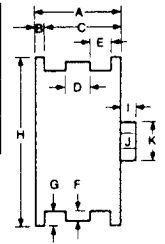

These all-new IdleMaster Tighteners from Black Ace are designed for use with both roller chains and belts. Their design allows a wide range of applications, including the tightest spots...extending the life of your roller chains and belts.

IdleMaster direct replacements for:

pitch 40 - 17 tooth	2641BE
pitch 50 - 15 tooth	2651BE
pitch 60 - 13 tooth	2661BE
pitch 80 - 12 tooth	2681BE

- Interchangeable with most idler sprockets.
- Easy to install.
- Ideal for high-pressure-point areas.
- Precision machined of heavy-duty steel to last much longer!
- Perform smoothly on both worn and new chains.
- Can be stacked for double-chain and wide belt applications.
- Bushings to accommodate 3 bolt hole sizes.
- Superior replacements for all types of equipment.

PART NO.	DESCRIPTION	A	B	C	D	E	F	G
PTP 2641BE	No. 40 pitch chain	.550	.290	1.130	2.500	.085	.219	5/8 - 1/2 - 3/8
PTP 2651BE	No. 50 pitch chain	.550	.370	1.130	3.150	.085	.407	5/8 - 1/2 - 3/8
PTP 2661BE	No. 60 pitch chain	.550	.489	1.130	3.150	.085	.407	5/8 - 1/2 - 3/8
PTP 2681BC3	No. 80 pitch chain	.667	.580	.937	3.340	.050	.380	1/2 - 5/8 - 3/4
PTP 2632BD3	Flat belt tensioner	2.125	-	1.130	2.950	.075	-	1/2 - 5/8 - 3/4
PTP 2011ABE3	Flanged belt pulley	1.550	1.250	1.130	4.150	.035	.528	1/2 - 5/8 - 3/4

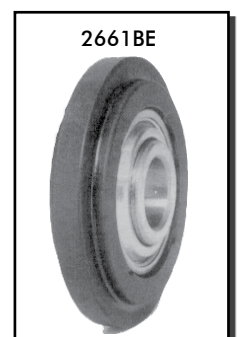
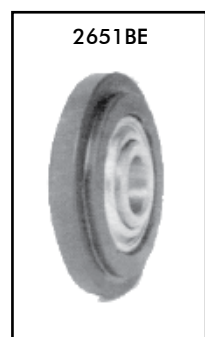
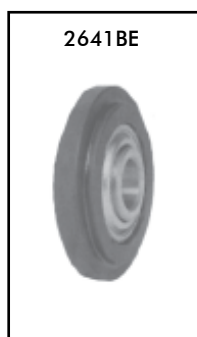
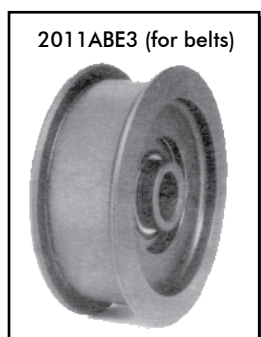
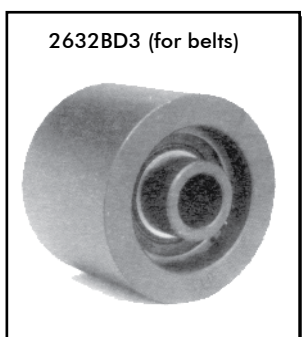
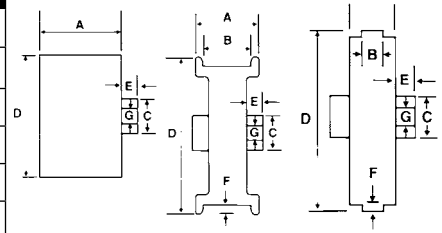

ROLLER ASSEMBLIES

For Case-IH & New Holland Combines

Reduces Noise & Wear!

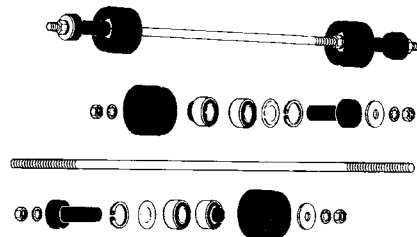

Black Ace's IH35 roller assembly makes your combine noticeably quieter by keeping feeder chains quiet. It reduces feeder chain wear and extends chain life.

The assembly includes a double bearing roller, bolt with nut, and mounting shaft.

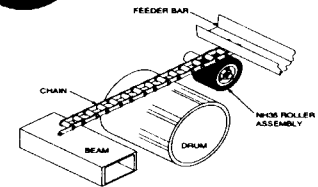
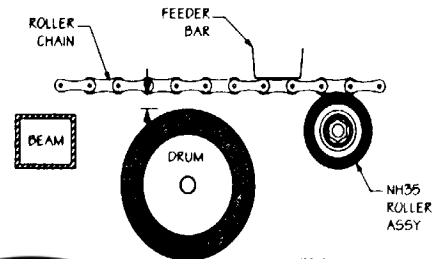

PART NO.	FOR USE ON
PTP IH35K37	CASE-IH 60 Series Combines
PTP IH35K47	CASE-IH 80 Series Combines
PTP IH35	CASE-IH All Axial Flow Comines (without shaft)
PTP IH35K473	CASE-IH 80 Series Combines with 3 Strand Feeder Chains
PTP NH35	Most NEW HOLLAND TR Series 70, 75, 85, 86, 95, 96 & 97
PTP BGAS/351	Replacement Bearing

- Easy installation
- Quiet, long-lasting & maintenance free
- Combine will run noticeably quieter
- Minimizes maintenance time on your machine
- Reduces wear on feeder bars and feeder bar slides by keeping chain off the slides
- Reduces wear on roller chain and chain wear plate

FEEDER CHAIN DRIVE SPROCKETS (FOR MOST COMBINES)

Black Ace split sprockets are precision manufactured of heat-treated steel for long life and less down time. They maintain accurate pitch and perfect timing, greatly reducing chain wear; grade 8 bolts secure them tightly to the hex shaft. Forget about the hassle time and cost of pulling out the hex shaft to change sprockets. Super-easy installation!



PART NO.	OEM NO.	FOR USE ON	DESCRIPTION
PTP H5509NHIH	1970248C1	Case-IH	9 teeth, 1 1/2" hex bore
PTP H55010MHJD	H118583	John Deere	10 teeth, 1 3/4" hex bore
PTP H55013NHG	71357768	Gleaner	13 teeth, 1 1/2" hex bore
PTP H55012MHNH	766380	New Holland	12 teeth, 1 3/4" hex bore
PTP H55012MHNHO	Split Ring Outside Drive Sprocket		

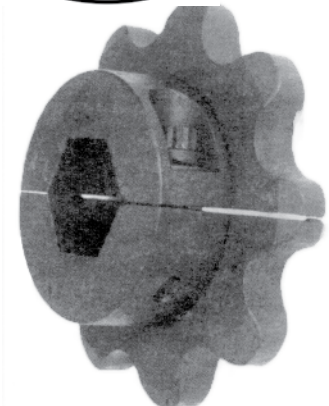

See Section 5 for a Great Selection of Roller Chains!

BEARING ASSEMBLIES

For Case-IH Rotary Combines

BLACK ACE BEARING HOLDERS easily upgrade the wooden block bearings on grain-pan augers - without replacing the block or removing the auger. The precision-machined steel shaft fits into the end of the auger, making it run true and turn more easily for long trouble-free life.



PART NO.	OEM NO.
PTP IH52	193414C2

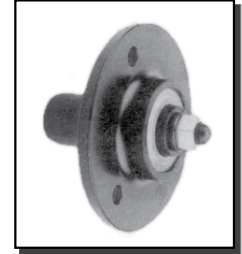

ELEVATOR CHAIN SPROCKETS (FOR MOST COMBINES)

BLACK ACE HEAT-TREATED STEEL SPLIT SPROCKETS make replacement of tank and return elevator sprockets faster and easier. They can be installed without pulling out the shaft and disassembling other component parts. They are secured tightly on the shaft.



Case-IH

PART NO.	OEM NO.	DESCRIPTION
PTP H5507A5	168683C1	7 teeth, 1" bore
PTP H5507B6	1319176C1	7 teeth, 1 1/4" bore
PTP H5507Q6	1302200C1	7 teeth, 1 1/8" bore
PTP H5509B6	1317192C1	9 teeth, 1 1/4" bore
PTP H5509C6	143960A1	9 teeth, 1 3/8" bore

John Deere

PART NO.	OEM NO.	DESCRIPTION
PTP H5508A6	H103576	8 teeth, 1" bore
PTP H5508B6	H91334	8 teeth, 1 1/4" bore

Black Ace split sprockets may work on other makes and models of combines that require the same number of teeth and bore size shown.

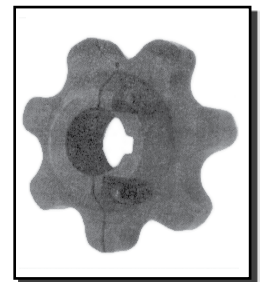

IDLER ROLLERS



Features...

- High tech urethane material & high quality greaseless bearing assembly with superior bonding of all materials.
- 4" or 5" diameter x 1" wide.
- 5/8" bolt mounting (with 1/2" bushing).
- Durable construction, made to take shock, light to moderate loads.

Benefits...

- Quiet, long-lasting and maintenance free.
- Extremely wear resistant - Reduces downtime & replacement parts costs.
- Light weight, inexpensive and cost effective.
- Versatile - one roller for many applications.

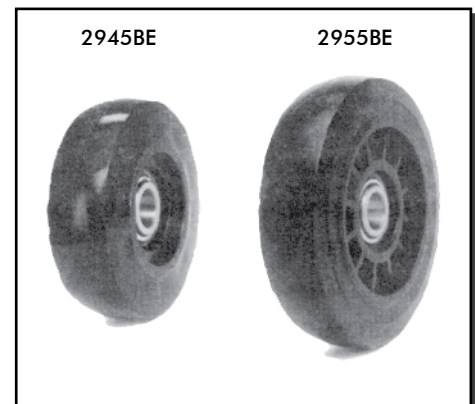

PART NO.	DIAMETER
PTP 2945BE	4"
PTP 2955BE	5"

HUBS FOR MARKERS & COULTERS

Precision-machined steel Black Ace cultivator coultter hubs feature easy installation and long, maintenance-free life. Two sealed easy-to-replace 6203 bearings are included, along with dust cap, bolts and self-locking nuts. You can use your existing discs.

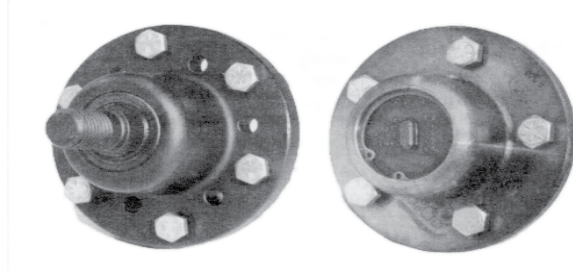
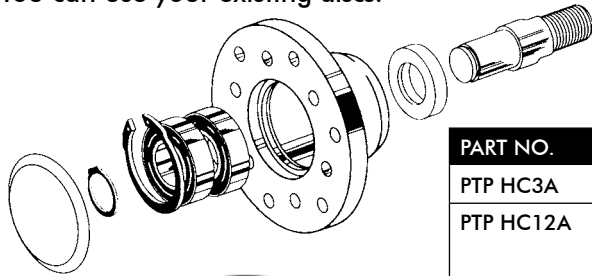

PART NO.	DESCRIPTION	FITS	INCLUDES
PTP HC3A	Coultter Hub	5 5/16" holes, 3" bolt-hole circles	5 5/16" bolts
PTP HC12A	Marker Hub	Fit hubs with 5/8" bolt holes Fits Case-IH (90850C92) & John Deere (AA27928) 6-hole, 3" bolt hole circle 6-hole, 2 1/2" bolt hole circle	6 1/4" bolts

Grease filled auxiliary seals with replaceable 6203 bearings.

CASE-IH SOCKET TOOL

The IHS Socket Tool for your Case-IH disc coultters.

Save your bolts • Speed up your repairs • Eliminate injury

- For 1/2" drive.
- Made from high quality steel in the U.S.A.
- Fits grain drills and seeder models 610, 620, 6200 and air drill model 8600.

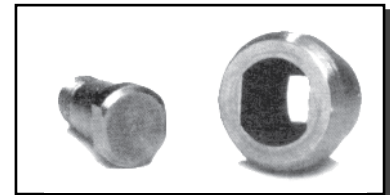

PART NO.

PTP IH5

ABOUT THE COMPANY BEHIND BLACK ACE PARTS...

A comprehensive line of Black Ace Quality Parts and other specialized parts are produced and manufactured by TEROG Manufacturing company. Based in Stephen, MB, this family-owned business has over a quarter century of experience in developing innovative, durable parts that meet and often exceed the needs of today's equipment. Black Ace Parts are designed for easy installation, low maintenance, heavy-duty strength and adaptability. Many Black Ace Parts are interchangeable, working in several applications, minimizing costly downtime and improving performance on all types of equipment.



BLACK ACE TROUBLESHOOTING GUIDE

PROBLEM: The roller chain tightens and loosens to an excessive degree.

POSSIBLE CAUSE: The run-out of drive sprockets causes the chain to lope. Since shafts are usually undersized (from .001 to .005 inch) and bores are generally oversized, the sprocket may come slightly off-center when the set screws are tightened. Even a small amount of run-out causes chain lope.

SOLUTION: Use the Snugulator Tightener to absorb the tightening and loosening of the chain. Also, try a tighter fit or a taper-lock hub.

POSSIBLE CAUSE: The sprocket shaft is slightly bent, causing the sprocket to move in all directions.

SOLUTION: The Snugulator Tightener will help to some degree, but you should also replace the shaft.

POSSIBLE CAUSE: Accumulated run-out causes large variations in the length of chain needed on the drive. The greater the number of sprockets in contact with the chain drive, the greater the chain movement. A rhythm develops as the chain is running.

SOLUTION: When installed in the correct locations, the Snugulator Tightener will take up much of the variation; it may create a substantial improvement in performance. On a long drive with several sprockets, it's important to keep sprocket run-out to a minimum. Even very slight run-out creates noticeable movement on a chain tightener.

Illustration shows run out of a typical drive and load sprocket. At high points, to the outside, chain is tight and at low points, chain is loose. Snugulator tightener absorbs the run-out, keeping the roller chain tensioned to all points, eliminating flexing and noise.

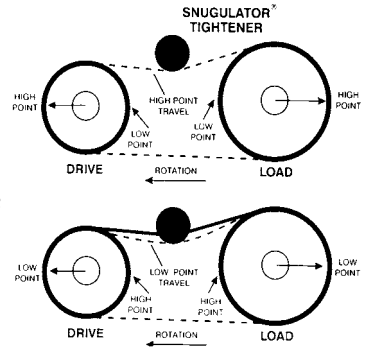

PROBLEM: The chain is whipping on the power side, making a vibrating, snapping sound.

POSSIBLE CAUSE: The chain or sprocket is worn, causing chain grouping. When chain pitch is greater than the pitch of the sprocket tooth, some chain rollers fail to come in contact with the bottom of the tooth. As this section of chain comes off the load sprocket, the sudden excess of chain causes a momentary slack. The drive sprocket takes it up, quickly and forcibly, creating a snap or jerk accompanied by noise, vibration and undue stress on the entire train.

This condition can also occur on new chain and sprockets when the load is on a large-diameter sprocket. The tolerance built into both sprocket and chain make it difficult to match them with great precision. This is why sprockets must be slightly undersized to accept the new chain. Slight whipping will begin as soon as the chain's pitch increases due to normal wear.

SOLUTION: Position a Snugulator Tightener slightly deflecting the chain as it comes off the load sprocket. (This works with both new and worn chain.) Replace worn chain. Excessive chain wear may cause chain links to group up on the sprocket.

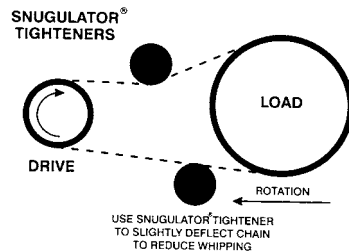

PROBLEM: The roller chain is getting hot.

POSSIBLE CAUSE: The chain may be moving too fast.

SOLUTION: Lubricate the chain to reduce friction. Substitute chain with a multiple smaller pitch.

POSSIBLE CAUSE: The load is too heavy for the pitch.

SOLUTION: Use a heavier chain or multiple chains of the same pitch. Install Snugulator or IdleMaster Tighteners.

PROBLEM: Chain and/or sprockets are showing rapid excessive wear.

Sprockets and chain do wear, even under the most ideal conditions. But this wear can become excessive due to several possible factors: •Heat • Sprocket run-out • Incorrect match of pitch between sprockets and roller chain • Roller spin • Environmental factors • Load • Quality of the parts • Excessive flexing

POSSIBLE CAUSE: Roller chain is flexing and jumping, causing overall vibration.

SOLUTION: Use Snugulator and/or IdleMaster Tighteners as shown on the installation diagrams.

POSSIBLE CAUSE: Check chain and sprocket wear.

SOLUTION: If worn, replace both.

POSSIBLE CAUSE: Check sprockets alignment.

SOLUTION: Align sprockets with a straight-edge.

POSSIBLE CAUSE: Inspect the chain assembly for excessive roller wear, increasing chain pitch.

SOLUTION: Use Snugulator and/or IdleMaster Tighteners.

A high degree of roller spin may also cause chain to wear. When sprocket idlers are used as tighteners, rollers often spin as sprockets engage and disengage the chain. Often overlooked, this condition becomes more noticeable as chain wears.

Wear results when the links flex to conform with the sprocket. While a certain amount of wear is normal, an excessive amount is likely to be caused by whipping and vibrating on the slack side. The Snugulator Tightener can be used to dampen the whipping, flexing and vibration; or use the IdleMaster Tightener in high-stress areas. Neither tightener is influenced by chain wear; both reduce roller spin.

#850 FHP SHEAVE AND SPLIT TAPER BUSHING ASSORTMENT

PART NO.

PTP 850

- 12 Finished Bore Series "A" Sheaves
- 28 Finished Bore Series "B" Sheaves
- 17 Bushing Style Sheaves
- 40 H-Bushings
- Attractive Merchandising Display

Display consists of the following:

FINISHED BORE SHEAVES	
1 ea.	AS17 - 1/2, 5/8, 3/4
1 ea.	AS20 - 1/2, 5/8, 3/4
1 ea.	AS23 - 1/2, 5/8, 3/4
1 ea.	AS25 - 1/2, 5/8, 3/4
1 ea.	BK24 - 1/2, 5/8, 3/4
1 ea.	BK25 - 1/2, 5/8, 3/4
1 ea.	BK26 - 1/2, 5/8, 3/4
1 ea.	BK27 - 1/2, 5/8, 3/4
1 ea.	BK28 - 1/2, 5/8, 3/4, 7/8
1 ea.	BK30 - 1/2, 5/8, 3/4, 7/8
1 ea.	BK32 - 1/2, 5/8, 3/4, 7/8
1 ea.	BK34 - 1/2, 5/8, 3/4, 7/8

BUSHING TYPE SHEAVES	
1 ea.	BK30H
1 ea.	BK32H
1 ea.	BK34H
1 ea.	BK36H
1 ea.	BK40H
1 ea.	BK45H
1 ea.	BK50H
1 ea.	BK55H
1 ea.	BK60H

BUSHINGS	
2 ea.	H - 1/2
2 ea.	H - 9/16
2 ea.	H - 5/8
4 ea.	H - 3/4
4 ea.	H - 7/8
2 ea.	H - 15/16
4 ea.	H - 1
2 ea.	H - 1 1/16

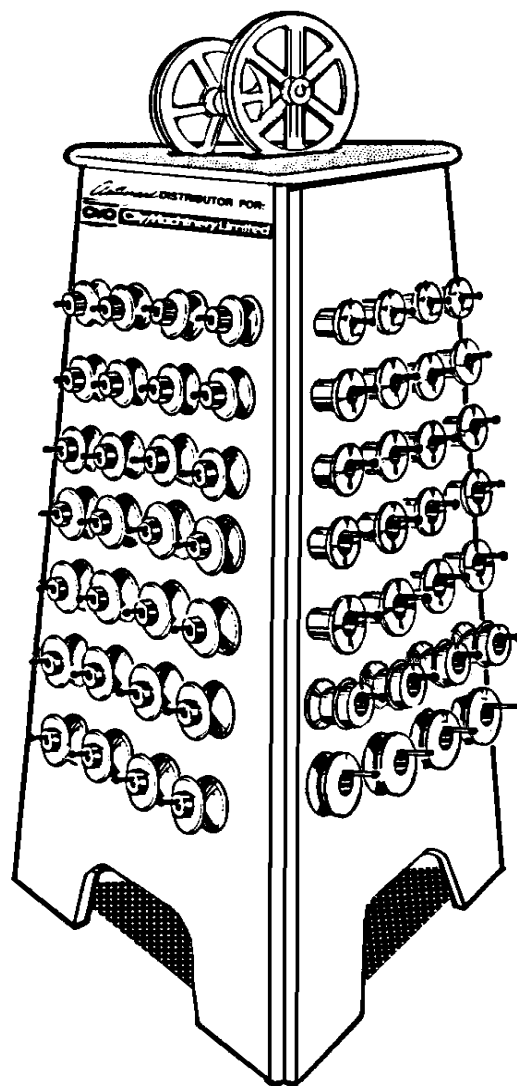

This attractive floor-standing display uses little space and offers easy self-serve appeal!

BROWNING BUSHINGS

Split Taper, QD and Taper Bore Designs

The Broadest Range of Bushing Systems from a Single Source

Browning Split Taper Bushings

- Made of tough malleable iron - virtually indestructible.
- Keyed to both shaft and hub - external key provides positive drive with no torque on the capscrews.
- Highest torque carrying capacity.
- Double split barrel assures true concentricity - grips the shaft with positive clamp fit.
- Standard sizes - 3/8" - 10" bore sizes.
- Metric sizes - 10 mm - 95 mm bore sizes.
- Spline bore - 5/8" - 1 3/8", 6B & 10B, 10 & 21 involute.
- For use with and interchangeable in the full range of Browning sheaves, sprockets, gears, pulls, couplings and hubs.

Along with the proven split taper bushing, Browning offers the QD and taper bore bushing systems.

No other manufacturer gives you this broad selection!

Depending on your drive requirements, select from any of these bushing systems to obtain the most effective combination of components, or choose your own preferred bushing type.

Browning QD Bushings

- Standard sizes - 1/2" - 7" bore range.
- Metric sizes - 24 mm - 100 mm bore range
- For use with Browning sheaves, sprockets and pulleys; fully interchangeable with competitive QD bushings.

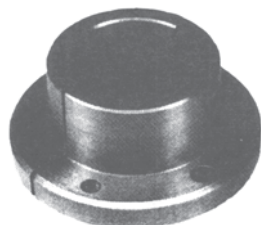

QD Bushing

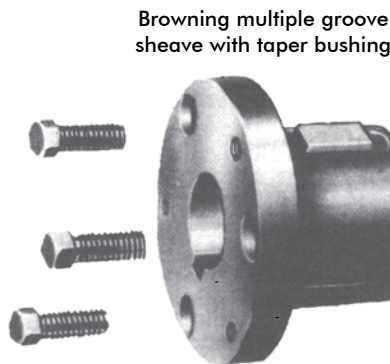

Browning multiple groove sheave with taper bushing

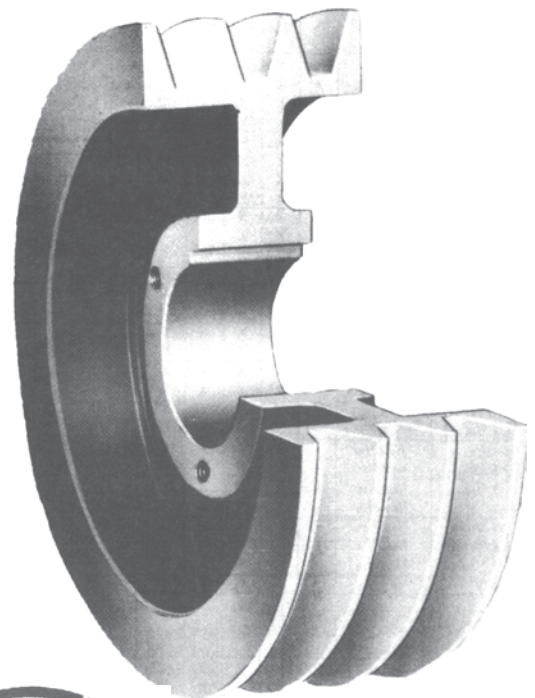

Browning Taper Bore Bushings

- Standard sizes - 1/2" - 10" bore range
- For use with Browning sprockets

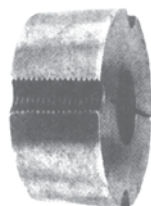

Taper Bore Bushing

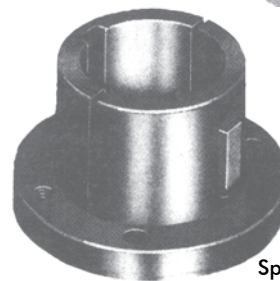

Split Taper Bushing

BROWNING SPLIT TAPER BUSHING

PART NO.	DIMENSIONS											BORE RANGE		CAP SCREWS			WRENCH TORQUE	
	L	U	T	D LARGE END	SMALL END	H	V	W	X	Y	R	S	TYPE 1	TYPE 2	NO.	SIZE		AVG WT (LBS)
PTP G	1"	1/4"	3/4"	1.172"	1.133"	2"	1 9/16"	-	5/8"	3/16"	1/8"	3/16"	3/8" - 15/16"	1"	2	1/4" x 5/8"	.5	95
PTP H	1 1/4	1/4	1	1.625	1.570	2 1/2	2	-	7/8	3/16	1/8	3/16	3/8 - 1 3/8	1 7/16 - 1 1/2	2	1/4 x 3/4	.8	95
PTP P1	1 15/16	13/32	1 17/32	1.9375	1.8555	3	2 7/16	3/8"	1 5/16	7/32	7/32	1/4	1/2 - 1 7/16	1 1/2 - 1 3/4	3	5/16 x 1	1.3	95
PTP P2	2 15/16	13/32	2 17/32	1.9375	1.7930	3	2 7/16	3/8	2 5/16	7/32	7/32	1/4	3/4 - 1 7/16	1 1/2 - 1 3/4	3	5/16 x 1	1.5	192
PTP B	1 15/16	1/2	1 7/16	2.625	2.5567	3 11/16	3 1/8	1/2	1 3/16	7/32	1/4	1/4	1/2 - 1 15/16	2 - 2 7/16	3	5/16 x 1 1/4	1.8	192
PTP Q1	2 1/2	17/32	1 31/32	2.875	2.7657	4 1/8	3 3/8	1/2	1 3/4	7/32	7/32	9/32	3/4 - 2 1/16	2 1/8 - 2 11/16	3	3/8 x 1 1/4	3.5	348
PTP Q2	3 1/2	17/32	2 31/32	2.875	2.7032	4 1/8	3 3/8	1/2	2 3/4	7/32	7/32	9/32	1 - 2 1/16	2 1/8 - 2 5/8	3	3/8 x 1 1/4	4.5	348
PTP R1	2 7/8	5/8	2 1/4	4.000	3.8750	5 3/8	4 5/8	3/4	2	1/4	1/4	9/32	1 1/8 - 2 13/16	2 7/8 - 3 3/4	3	3/8 x 1 3/4	7.5	348
PTP S1	4 3/8	3/4	3 5/8	4.625	4.4180	6 3/8	5 3/8	3/4	3 5/16	5/16	5/16	3/8	1 11/16 - 3 3/16	3 1/4 - 4 1/4	3	1/2 x 2 1/4	13.5	840

Stock Inch Bore Sizes

STOCK BORES	KEYSEAT	G	H	P1	P2	B	Q1	Q2	R1	S1
3/8"	none	X	X	-	-	-	-	-	-	-
7/16	none	X	X	-	-	-	-	-	-	-
1/2	1/8 x 1/16	X	X	X	-	X	-	-	-	-
9/16	1/8 x 1/16	X	X	X	-	X	-	-	-	-
1 1/32	3/16 x 3/32	X	X	X	-	X	-	-	-	-
1 1/16	3/16 x 3/32	X	X	X	-	X	-	-	-	-
1 1/8	3/16 x 3/32	X	X	X	-	X	-	-	-	-
1 1/4	3/16 x 3/32	X	X	X	-	X	-	-	-	-
1 1/2	3/16 x 3/32	X	X	X	-	X	-	-	-	-
1 5/8	3/16 x 3/32	X	X	X	-	X	-	-	-	-
1 3/4	3/16 x 3/32	X	X	X	-	X	-	-	-	-
2	3/16 x 3/32	X	X	X	-	X	-	-	-	-
2 1/8	3/16 x 3/32	X	X	X	-	X	-	-	-	-
2 1/4	3/16 x 3/32	X	X	X	-	X	-	-	-	-
2 1/2	3/16 x 3/32	X	X	X	-	X	-	-	-	-
2 3/4	3/16 x 3/32	X	X	X	-	X	-	-	-	-
3	3/16 x 3/32	X	X	X	-	X	-	-	-	-

Stock Millimeter Bore Sizes

STOCK BORES	KEYSEAT	G	H	P1	B	Q1	R1
10 mm	none	X	X	-	-	-	-
11 mm	none	X	X	-	-	-	-
12 mm	none	X	X	-	-	-	-
14 mm	5 x 2.5	X	X	X	-	-	-
15 mm	5 x 2.5	-	-	X	X	-	-
16 mm	2 x 2.5	X	X	X	X	-	-
18 mm	6 x 3	X	X	X	X	-	-
19 mm	6 x 3	X	X	X	X	-	-
20 mm	6 x 3	X	X	X	X	-	-
22 mm	6 x 3	X	X	X	X	-	-
24 mm	8 x 3.5	X	X	X	X	-	-
25 mm	8 x 3.5	X	X	X	X	-	-
28 mm	8 x 3.5	-	X	X	X	X	-
30 mm	8 x 3.5	-	X	X	X	X	-
32 mm	10 x 4	-	X	X	X	X	-
35 mm	10 x 4	-	X	X	X	X	X
36 mm	10 x 4	-	X	X	X	X	X

STOCK BORES	KEYSEAT	G	H	P1	B	Q1	R1
38 mm	10 x 4	-	X	X	X	X	X
39 mm	12 x 4	-	-	X	X	X	X
40 mm	12 x 4	-	-	X	X	X	X
42 mm	12 x 4	-	-	X	X	X	X
45 mm	14 x 4.5	-	-	-	X	X	X
48 mm	14 x 4.5	-	-	-	X	X	X
50 mm	14 x 4.5	-	-	-	X	X	X
55 mm	16 x 5	-	-	-	X	X	X
60 mm	18 x 5.5	-	-	-	X	X	X
65 mm	18 x 5.5	-	-	-	X	X	X
70 mm	20 x 6	-	-	-	-	-	X
75 mm	20 x 6	-	-	-	-	-	X
80 mm	22 x 7	-	-	-	-	-	X
85 mm	22 x 7	-	-	-	-	-	X
90 mm	25 x 7	-	-	-	-	-	X
95 mm	25 x 7	-	-	-	-	-	X

- Made of tough malleable iron - virtually indestructible.
- Keyed to both shaft and hub. External key provides positive drive with no torque on the capscrews.
- Highest torque carrying capacity.
- Double split barrel assures true concentricity - grips the shaft with positive clamp fit.
- Standard sizes 3/8" - 10" bore sizes.
- Metric sizes 10 mm - 95 mm bore sizes.
- Spline bore - 5/8" - 1 3/8", 6B & 10B, 10 & 21 involute.
- For use with and interchangeable in the full range of Browning sheaves, sprockets, gears, pulleys, couplings and hubs.

NOTE: Please specify shaft size when ordering. (i.e. PTP H-15/16) (i.e. PTP P1-1-1/4)

STOCK BORES	KEYSEAT	B	Q1	Q2	R1	S1
1 13/16"	1/2 x 1/4	X	X	X	X	-
1 7/8	1/2 x 1/4	X	X	X	X	X
1 15/16	1/2 x 1/4	X	X	X	X	X
2	1/2 x 1/4	X	X	X	X	X
2 1/16	1/2 x 1/4	X	X	X	X	-
2 1/8	1/2 x 1/4	X	X	X	X	X
2 3/16	1/2 x 1/4	X	X	X	X	X
2 1/4	1/2 x 1/4	X	X	X	X	X
2 5/16	5/8 x 5/16	X	X	X	X	X
2 3/8	5/8 x 5/16	X	X	X	X	X
2 7/16	5/8 x 5/16	X	X	X	X	X
2 1/2	5/8 x 5/16	X	X	X	X	X
2 5/8	5/8 x 5/16	-	X	X	X	X
2 3/4	5/8 x 5/16	-	X	X	X	X
2 7/8	5/8 x 5/16	-	X	X	X	X
2 15/16	5/8 x 5/16	-	X	X	X	X
3	5/8 x 5/16	-	X	X	X	X
3 3/4	3/4 x 3/8	-	-	-	X	X
3 1/2	3/4 x 3/8	-	-	-	X	X
3 5/8	3/4 x 3/8	-	-	-	X	X
3 3/4	3/4 x 3/8	-	-	-	X	X

STOCK BORES	KEYSEAT	R1	S1
3 3/8"	7/8 x 7/16	X	-
3 7/16	7/8 x 7/16	X	X
3 1/2	7/8 x 7/16	X	X
3 5/8	7/8 x 7/16	X	X
3 11/16	7/8 x 7/16	X	-
3 3/4	7/8 x 7/16	X	X
3 7/8	1 x 1/2	-	X
3 15/16	1 x 1/2	-	X
4	1 x 1/2	-	X
4 1/8	1 x 1/2	-	X
4 3/16	1 x 1/2	-	X
4 1/4	1 x 1/2	-	X
4 5/8	1 x 1/2	-	-
4 7/16	1 x 1/2	-	-
4 1/2	1 x 1/2	-	-
4 5/8	1 1/4 x 5/8	-	-
4 11/16	1 1/4 x 5/8	-	-
4 3/4	1 1/4 x 5/8	-	-
4 7/8	1 1/4 x 5/8	-	-
4 15/16	1 1/4 x 5/8	-	-
5	1 1/4 x 5/8	-	-

Stock Spline Bore Bushings

STOCK BORES	H	P1	Q1
.978 - 10 Inv.	X	X	-
1 1/8 - 6B	X	X	X
1 1/4 - 10B	-	X	-
1 3/8 - 6B	X	X	X
1 3/8 - 10B	-	X	X
1 3/8 - 21 Inv.	X	X	X

QD BUSHINGS

Bushing Specifications

BUSHING	BORE RANGE	DIMENSIONS							CAP SCREWS		BOLT CIRCLE	TORQUE CAPACITY IN LBS	WRENCH TORQUE IN LBS	AVG. WEIGHT LBS
		D	L	A	B	C	E	F	NO.	SIZE				
PTP JA	1/2" - 1 1/4"	2"	1"	1/2"	1.375"	3/16"	1 1/16"	5/16"	3	10-24 x 1	1 21/32	1,000	6	.8
PTP SH	1/2 - 1 5/8	2 11/16	1 5/16	21/32	1.871	7/32	7/8	7/16	3	1/4 - 20 x 1 3/8	2 1/4	3,500	9	1.0
PTP SDS	1/2 - 2	3 1/8	1 5/16	21/32	2.1875	7/32	7/8	7/16	3	1/4 - 20 x 1 3/8	2 11/16	5,000	9	1.2
PTP SD	1/2 - 2	3 1/8	1 13/16	1 5/32	2.1875	7/32	1 3/8	7/16	3	1/4 - 10 x 1 7/8	2 11/16	5,000	9	1.5
PTP SK	1/2 - 2 5/8	3 7/8	1 15/16	1 5/32	2.8128	7/32	1 3/8	9/16	3	5/16 - 18 x 2	3 5/16	7,000	15	2.0
PTP SF	1/2 - 2 15/16	4 5/8	2 1/16	1 7/32	3.125	7/32	1 7/16	5/8	3	3/8 - 16 x 2	3 7/8	11,000	30	3.5
PTP E	7/8 - 3 1/2	6	2 3/4	1 19/32	3.834	9/32	1 7/8	7/8	3	1/2 - 13 x 2 3/4	5	20,000	60	9.0
PTP F	1 - 4	6 5/8	3 3/4	2 13/32	4.4375	11/32	2 3/4	1	3	9/16 - 12 x 3 5/8	5 5/8	30,000	75	14
PTP J	1 1/2 - 4 1/2	7 1/4	4 5/8	3 3/16	5.1484	5/16	3 1/2	1 1/8	3	5/8 - 11 x 4 1/2	6 1/4	45,000	135	22
PTP M	2 - 5 1/2	9	6 3/4	5 5/32	6.494	11/32	5 1/2	1 1/4	4	3/4 - 10 x 6 3/4	7 7/8	85,000	225	51
PTP N	2 7/16 - 5 7/8	10	8 1/8	6 1/16	6.992	9/16	6 5/8	1 1/2	4	7/8 - 9 x 8	8 1/2	150,000	300	66
PTP P	2 15/16 - 7	11 3/4	9 3/8	7	8.242	5/8	7 5/8	1 3/4	4	1 - 8 x 9 1/2	10	250,000	450	122

NOTE: All bushings shown except JA have setscrew over keyway.

Stock Millimeter Bore Bushings

STOCK BORES	KEYSEAT	SH	SDS	SD	SK	SF	E	F	J
24 mm	8 x 3.5	x	x	x	x	-	-	-	-
25 mm	8 x 3.5	x	x	x	x	-	-	-	-
28 mm	8 x 3.5	x	x	x	x	-	-	-	-
30 mm	8 x 3.5	x	x	x	x	-	-	-	-
32 mm	10 x 4	x	x	x	x	-	-	-	-
35 mm	10 x 4	x	x	x	x	x	x	-	-
38 mm	10 x 4	-	x	x	x	x	x	-	-
40 mm	12 x 4	-	x	x	x	x	x	-	-
42 mm	12 x 4	-	x	x	x	x	x	-	-
45 mm	14 x 4.5	-	-	-	-	x	x	x	-
48 mm	14 x 4.5	-	x	-	x	x	x	x	-
50 mm	14 x 4.5	-	-	-	x	x	x	x	x
55 mm	16 x 5	-	-	-	x	x	x	x	x
60 mm	18 x 5.5	-	-	-	-	x	x	x	x
65 mm	18 x 5.5	-	-	-	-	-	x	x	x
70 mm	20 x 6	-	-	-	-	-	x	x	x
75 mm	20 x 6	-	-	-	-	-	x	x	x
80 mm	22 x 7	-	-	-	-	-	-	x	x
85 mm	22 x 7	-	-	-	-	-	-	x	x
90 mm	22 x 7	-	-	-	-	-	-	x	x
95 mm	25 x 7	-	-	-	-	-	-	-	x
100 mm	25 x 8	-	-	-	-	-	-	-	x

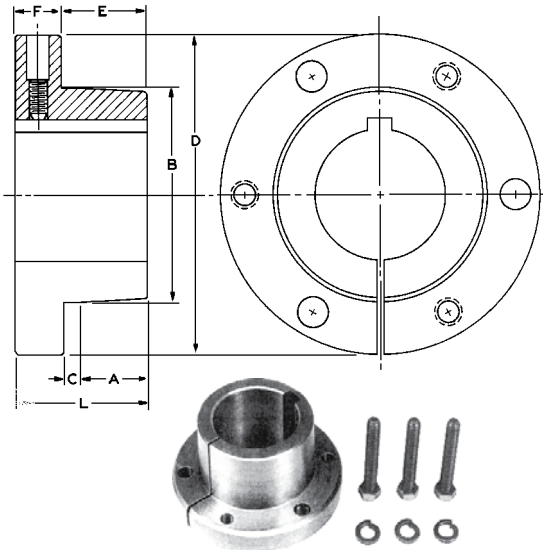

Note: Please specify bore size when ordering. (i.e. PTP SDS-3/4")

S = Stock bore shallow keyway

N = Stock bore no keyway

X = Stock bore standard keyway

Stock Inch Bore Bushings

STOCK BORES	KEYSEAT	JA	SH	SDS	SD	SK	E	F	J	STOCK BORES	KEYSEAT	SDS	SD	SK	SF	E	F	J	M	N	STOCK BORES	KEYSEAT	SF	E	F	J	M	N	P	
1/2	1/8 x 1/16	x	x	x	x	x	-	-	-	1 3/4	1/8 x 1/16	S	S	X	X	X	X	X	-	-	2 11/16	5/8 x 5/16	S	X	X	X	X	X	-	
9/16	1/8 x 1/16	x	x	x	x	x	-	-	-	1 13/16	1/8 x 1/16	S	S	X	X	X	X	X	-	-	2 3/4	5/8 x 5/16	S	X	X	X	X	X	-	
5/8	3/16 x 3/32	x	x	x	x	x	-	-	-	1 7/8	3/16 x 3/32	S	S	X	X	X	X	X	-	-	2 13/16	3/4 x 3/8	S	X	X	X	X	X	-	
11/16	3/16 x 3/32	x	x	x	x	x	-	-	-	1 15/16	3/16 x 3/32	S	S	X	X	X	X	X	-	-	2 7/8	3/4 x 3/8	S	X	X	X	X	X	-	
3/4	3/16 x 3/32	x	x	x	x	x	-	-	-	2	3/16 x 3/32	N	N	X	X	X	X	X	-	-	2 15/16	3/4 x 3/8	S	S	X	X	X	X	X	
13/16	3/16 x 3/32	x	x	x	x	x	-	-	-	2 1/16	3/16 x 3/32	-	-	X	X	X	X	X	-	-	3	3/4 x 3/8	-	S	X	X	X	X	X	
7/8	3/16 x 3/32	x	x	x	x	x	-	-	-	2 1/8	3/16 x 3/32	-	-	X	X	X	X	X	-	-	3 1/16	3/4 x 3/8	-	S	X	X	X	X	X	
15/16	1/4 x 1/8	x	x	x	x	x	-	-	-	2 3/16	1/4 x 1/8	-	-	S	X	X	X	X	-	-	3 1/8	3/4 x 3/8	-	S	X	X	X	X	X	
1	1/4 x 1/8	x	x	x	x	x	-	-	-	2 1/4	1/4 x 1/8	-	-	S	X	X	X	X	-	-	3 3/16	3/4 x 3/8	-	S	X	X	X	X	X	
1 1/16	1/4 x 1/8	s	x	x	x	x	-	-	-	2 5/16	1/4 x 1/8	-	-	S	S	X	X	X	-	-	3 1/4	3/4 x 3/8	-	S	X	X	X	X	X	
1 1/8	1/4 x 1/8	s	x	x	x	x	-	-	-	2 3/8	1/4 x 1/8	-	-	S	S	X	X	X	-	-	3 5/16	7/8 x 7/16	-	S	S	X	X	X	X	
1 3/16	1/4 x 1/8	s	x	x	x	x	-	-	-	2 1/2	1/4 x 1/8	-	-	S	S	X	X	X	X	-	-	3 3/8	7/8 x 7/16	-	S	S	X	X	X	X
1 1/4	1/4 x 1/8	-	x	x	x	x	-	-	-	2 7/16	1/4 x 1/8	-	-	S	S	X	X	X	X	-	-	3 7/16	7/8 x 7/16	-	S	S	X	X	X	X
1 5/16	5/16 x 5/32	-	x	x	x	x	-	-	-	2 9/16	5/16 x 5/32	-	-	N	S	X	X	X	X	-	-	3 1/2	7/8 x 7/16	-	S	S	X	X	X	X
1 5/16	3/8 x 3/16	-	x	x	x	x	-	-	-	2 5/8	3/8 x 3/16	-	-	N	S	X	X	X	X	-	-	3 9/16	7/8 x 7/16	-	S	S	X	X	X	X
1 3/8	5/16 x 5/32	-	x	x	x	x	-	-	-	3 5/8	7/8 x 7/16	-	-	S	X	X	X	X	-	-	3 5/8	7/8 x 7/16	-	-	S	X	X	X	X	
1 3/8	3/8 x 3/16	-	x	x	x	x	-	-	-	3 11/16	7/8 x 7/16	-	-	S	X	X	X	X	-	-	3 11/16	7/8 x 7/16	-	-	S	X	X	X	X	
1 7/16	3/8 x 3/16	-	s	x	x	x	-	-	-	3 3/4	7/8 x 7/16	-	-	S	X	X	X	X	-	-	3 3/4	7/8 x 7/16	-	-	S	X	X	X	X	
1 1/2	3/8 x 3/16	-	s	x	x	x	-	-	-	3 13/16	7/8 x 7/16	-	-	S	X	X	X	X	-	-	3 13/16	7/8 x 7/16	-	-	S	X	X	X	X	
1 9/16	3/8 x 3/16	-	s	x	x	x	-	-	-	3 7/8	1 x 1/2	-	-	S	S	X	X	X	-	-	3 7/8	1 x 1/2	-	-	S	S	X	X	X	
1 5/8	3/8 x 3/16	-	s	x	x	x	-	-	-	3 15/16	1 x 1/2	-	-	S	S	X	X	X	-	-	3 15/16	1 x 1/2	-	-	S	S	X	X	X	
1 11/16	3/8 x 3/16	-	-	s	s	x	-	-	-	4	1 x 1/2	-	-	N	S	X	X	X	-	-	4	1 x 1/2	-	-	N	S	X	X	X	

TAPER BORE BUSHINGS

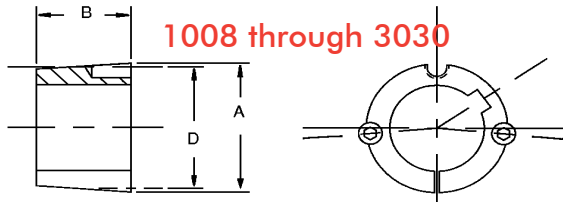

1008 through 3030

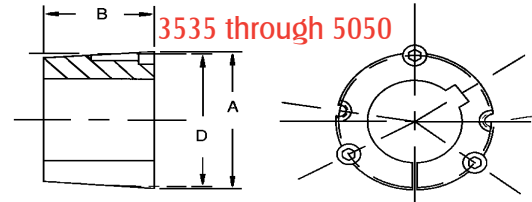

3535 through 5050

PART NO.	CAP SCREWS								WRENCH CAP. IN LBS.	TORQUE (APX.) IN LBS.	WEIGHT IN LBS.
	MAX. A	B	D BOLT CIRCLE	DIA.	LENGTH	MIN. STD.	SHALLOW KW.	TORQUE KW.			
PTP 1008	1 25/64"	7/8"	1 21/64"	1/4"	1/2"	1/2"	7/8"	1"	55	1,200	.27
PTP 1108	1.511	7/8	1 29/64	1/4	1/2	1/2	1	1 1/8	55	1,300	.33
PTP 1210	1 7/8	1	1 3/4	3/8	5/8	1/2	1 1/4	1 1/4	175	3,600	.61
PTP 1215	1 7/8	1 1/2	1 3/4	3/8	5/8	1/2	1 1/4	1 1/4	175	3,550	.80
PTP 1610	2 1/4	1	2 1/8	3/8	5/8	1/2	1 1/2	1 5/8	175	4,300	.90
PTP 1615	2 1/4	1 1/2	2 1/8	3/8	5/8	1/2	1 1/2	1 5/8	175	4,300	1.2
PTP 2012	2 3/4	1 1/4	2 5/8	7/16	7/8	1/2	1 7/8	2	280	7,150	1.7
PTP 2517	3 3/8	1 3/4	3 1/4	1/2	1	1/2	2 1/4	2 1/2	430	11,600	3.5
PTP 2525	3 3/8	2 1/2	3 1/4	1/2	1	3/4	2 1/4	2 1/2	430	11,300	4.9
PTP 3020	4 1/4	2	4	5/8	1 1/4	15/16	2 3/4	3	800	24,000	6.5
PTP 3030	4 1/4	3	4	5/8	1 1/4	15/16	2 3/4	3	800	24,000	9.2
PTP 3535	5	3 1/2	4.83	1/2	1 1/2	1 3/16	3 1/4	3 1/2	1000	44,800	14.0
PTP 4040	5 3/4	4	5.54	5/8	1 3/4	1 7/16	3 5/8	4	1700	77,300	22.0
PTP 4545	3 3/8	4 1/2	6.13	3/4	2	1 15/16	4 1/4	4 1/2	2450	110,000	30.0
PTP 5050	7	5	6.72	7/8	2 1/4	2 7/16	4 1/2	5	3100	126,000	38.0

NOTE: Please specify bore size when ordering. (i.e. PTP 1008-1")

	1008	1108	1210	1215	1610	1615	2012	2517	2525	3020	3030	35
1/2"	X	X	X	X	X	X	X	X	-	-	-	-
9/16	X	X	X	X	X	X	X	X	-	-	-	-
5/8	X	X	X	X	X	X	X	X	-	-	-	-
11/16	X	X	X	X	X	X	X	X	-	-	-	-
3/4	X	X	X	X	X	X	X	X	-	-	-	-
13/16	X	X	X	X	X	X	X	X	-	-	-	-
7/8	X	X	X	X	X	X	X	X	-	-	-	-
15/16	X	X	X	X	X	X	X	X	-	-	-	-
1	-	X	X	X	X	X	X	X	X	X	X	-
1 1/16	-	X	X	X	X	X	X	X	X	X	X	-
1 1/8	-	X	X	X	X	X	X	X	X	X	X	-
1 3/16	-	-	X	X	X	X	X	X	X	X	X	X
1 1/4	-	-	X	X	X	X	X	X	X	X	X	X
1 5/16	-	-	-	-	X	X	X	X	X	X	X	X
1 3/8	-	-	-	-	X	X	X	X	X	X	X	X

	3020	3030	3535	4040	4545	5050
2 11/16"	X	X	X	X	-	-
2 3/4	X	X	X	X	-	-
2 13/16	X	X	-	X	-	-
2 7/8	X	X	X	X	X	-
2 15/16	X	X	X	X	X	X
3	X	X	X	X	X	-
3 1/16	-	-	X	X	X	-
3 3/8	-	-	X	X	X	-
3 3/16	-	-	X	X	X	-
3 1/4	-	-	X	X	X	-
3 5/16	-	-	X	X	-	-
3 3/8	-	-	X	X	X	X
3 7/16	-	-	X	X	X	X
3 1/2	-	-	X	X	X	-
3 9/16	-	-	-	X	X	X
3 5/8	-	-	-	X	X	X
3 11/16	-	-	-	X	X	-
3 3/4	-	-	-	X	X	-
3 15/16	-	-	-	X	-	-
3 7/8	-	-	-	X	X	X
3 15/16	-	-	-	X	X	X
4	-	-	-	X	X	X
4 1/8	-	-	-	-	X	-
4 3/16	-	-	-	-	X	-
4 1/4	-	-	-	-	X	X
4 3/8	-	-	-	-	X	X
4 7/16	-	-	-	-	X	X
4 1/2	-	-	-	-	X	X
4 7/8	-	-	-	-	-	X
4 15/16	-	-	-	-	-	X
5	-	-	-	-	-	X

Standard Keyseats

BORE RANGE	KEYSEAT
1/2 - 9/16	1/8 - 1/16
5/8 - 7/8	3/16 - 3/32
15/16 - 1 1/4	1/4 - 1/8
1 3/16 - 1 3/8	5/16 - 3/32
1 7/16 - 1 3/4	3/8 - 3/16
1 13/16 - 2 1/4	1/2 - 1/4
2 5/16 - 2 3/4	5/8 - 5/16
2 13/16 - 3 1/4	3/4 - 3/8
3 3/8 - 3 3/4	7/8 - 7/16
3 7/8 - 4 1/2	1 - 1/2
4 5/8 - 5	1 1/4 - 5/8

(1 3/8" bore bushings also available with 3/8" x 3/16" keyway.)

	1610	1615	2012	2517	2525	3020	3030	3535	4040	4545	5050
1 7/16"	X	X	X	X	X	X	X	X	X	-	-
1 1/2	X	X	X	X	X	X	X	X	X	-	-
1 9/16	X	X	X	X	X	X	X	X	X	-	-
1 5/8	X	X	X	X	X	X	X	X	X	-	-
1 11/16	-	-	X	X	X	X	X	X	X	-	-
1 3/4	-	-	X	X	X	X	X	X	X	-	-
1 13/16	-	-	X	X	X	X	X	X	X	-	-
1 7/8	-	-	X	X	X	X	X	X	X	-	-
1 15/16	-	-	X	X	X	X	X	X	X	-	-
2	-	-	-	X	X	X	X	X	X	X	X
2 1/16	-	-	-	X	X	X	X	-	-	-	-
2 1/8	-	-	-	X	X	X	X	-	-	-	-
2 3/16	-	-	-	X	X	X	X	X	X	X	-
2 1/4	-	-	-	X	X	X	X	X	X	-	-
2 5/16	-	-	-	X	X	X	X	X	X	-	-
2 3/8	-	-	-	X	X	X	X	X	X	X	-
2 7/16	-	-	-	X	X	X	X	X	X	X	-
2 1/2	-	-	-	X	X	X	X	X	X	-	X
2 9/16	-	-	-	-	-	X	X	-	X	-	-
2 5/8	-	-	-	-	-	X	X	X	X	X	-

BROWNING IDLER BUSHINGS

Browning Idler Bushings provide idlers in the following products:

Furnished complete with ball bearings, capscrews, stud bolts, and nuts.

Available for H, P1, Q1 & R1 bore items.

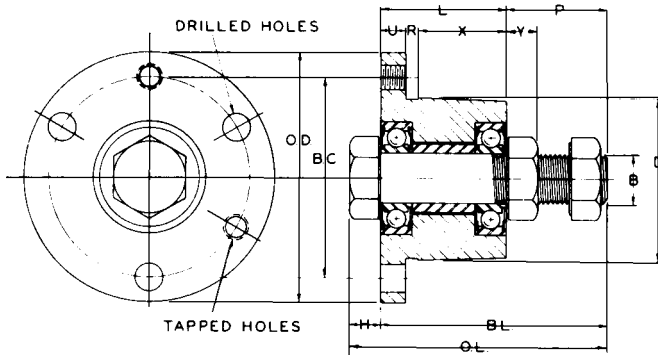

- Sheaves - FHP, Multiple, Poly-V & 358
- Gearbelt Pulleys
- Gears
- Hardened & Standard Sprockets - Single, Double & Triple

NOTE: Mount stud bolt in either direction.

PART NO.	DIMENSIONS												TAPPED HOLES		DRILLED HOLES		WEIGHT (APX.)
	O.D.	B.C.	D	B	O.L.	B.L.	H & Y	L	P	U	R	X	NO.	SIZE	NO.	SIZE	
PTP IDH1-1/2	2 1/2"	2"	1.625"	1/2"	2 9/16"	2 1/4"	5/16"	1 1/4"	1"	1/4"	1/8"	7/8"	2	1/4" - 20	2	5/16"	.9 lbs.
PTP IDP1-5/8	3	2 7/16	1.937	5/8	3 41/64	3 1/4	25/64	1 15/16	1 5/16	13/32	7/32	1 5/16	2	5/16 - 18	3	3/8	1.9
PTP IDQ1-3/4	4 1/8	3 3/8	2.875	3/4	4 7/32	3 3/4	15/32	2 1/2	1 1/4	17/32	7/32	1 3/4	2	3/8 - 16	3	7/16	5.5
PTP IDQ1-1	4 1/8	3 3/8	2.875	1	4 39/64	4	39/64	2 1/2	1 1/2	17/32	7/32	1 3/4	2	3/8 - 16	3	7/16	5.9
PTP IDR1-1-1/2	5 3/8	4 5/8	4.000	1 1/2	6 1/2	5 1/2	1	2 7/8	2 5/8	5/8	1/4	2	2	3/8 - 16	3	7/16	14.1

See Section 2 for a full range of Domestic & Imported Bearings.

BROWNING STEEL HUBS (FOR SPLIT TAPER BUSHINGS)

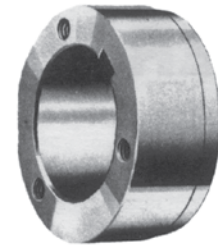
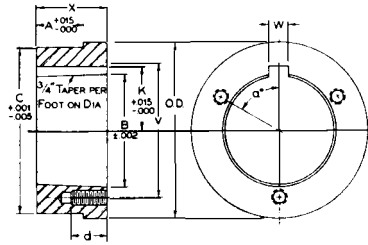

PART NO.	FOR BUSHING	DIMENSIONS										TAPPED HOLES		WEIGHT (LBS)
		O.D.	A	B	C	K	V	W	X	α	d	NO.	SIZE	
PTP HG1	G	2"	.174"	1.168"	1.875"	-	1 9/16"	-	5/8"	-	5/8"	2	1/4 - 20	.4
PTP HH1	H	2 1/2"	.174	1.621	2.375	-	2	-	7/8	-	7/8	2	1/4 - 20	.6
PTP HCH1	H	2 1/2"	.625	1.621	2.375	-	2	-	7/8	-	7/8	2	1/4 - 20	.7
PTP HP1	P1	3	.292	1.9375	2.875	1 3/32"	2 7/16	3/8"	1 5/16	60°	5/8	3	5/16 - 18	1.4
PTP HCP1	P1	3	1.000	1.9375	2.875	1 3/32	2 7/16	3/8	1 5/16	60	5/8	3	5/16 - 18	1.1
PTP HP2	P2	3	1.100	1.9375	2.875	1 3/32	2 7/16	3/8	2 5/16	60	5/8	3	5/16 - 18	2.5
PTP HB1	B	3 7/8"	.292	2.623	3.750	1 7/16	3 1/8	1/2	1 5/16	60	13/16	3	5/16 - 18	2.3
PTP HB2	B	4 1/2"	.709	2.623	4.375	1 7/16	3 1/8	1/2	1 3/4	60	13/16	3	5/16 - 18	4.7
PTP HQ1	Q1	4 1/2"	.709	2.875	4.375	1 9/16	3 3/8	1/2	1 3/4	60	7/8	3	3/8 - 16	4.4
PTP HCQ1	Q1	4 1/2"	1.250	2.875	4.375	1 9/16	3 3/8	1/2	1 3/4	60	7/8	3	3/8 - 16	4.4
PTP HQ2	Q2	4 1/2"	1.606	2.875	4.375	1 9/16	3 3/8	1/2	2 3/4	60	7/8	3	3/8 - 16	6.9
PTP HR1	R1	5 3/4"	.709	4.000	5.625	2 3/16	4 5/8	3/4	2	60	1 1/8	3	3/8 - 16	7.3
PTP HR2	R2	5 3/4"	1.606	4.000	5.625	2 3/16	4 5/8	3/4	4	60	1 1/8	3	3/8 - 16	15.4
PTP HS1	S1	6 3/4"	.946	4.625	6.500	2 9/16	5 3/8	3/4	3 5/16	60	1 5/8	3	1/2 - 13	17.3
PTP HS2	S2	6 3/4"	2.963	4.625	6.500	2 9/16	5 3/8	3/4	5 11/16	60	1 5/8	3	1/2 - 13	30.4
PTP HU0	U0	8 1/2"	2.000	6.000	8.250	3 1/4	7	1 1/4	3 3/4	60	2	3	5/8 - 11	32.0
PTP HU1	U1	8 1/2"	2.963	6.000	8.250	3 1/4	7	1 1/4	5 5/8	60	1 3/4	3	5/8 - 11	44.6
PTP HU2	U2	8 1/2"	6.016	6.000	8.250	3 1/4	7	1 1/4	8 5/8	60	1 3/4	3	5/8 - 11	69.0
PTP HW1	W1	12 1/2"	2.963	8.500	12.250	4 9/16	10	1 1/4	6 3/8	22 1/2	1 3/4	4	3/4 - 10	130.0

**See Section 5 for our
complete line of TQP Belts.**

BROWNING VARIABLE SPEED DRIVES

For changing speed frequently, rapidly and efficiently.

Browning offers one of the world's most complete selections of in-stock variable speed drives including variable pitch sheaves through 750 HP.

LVP variable speed sheave

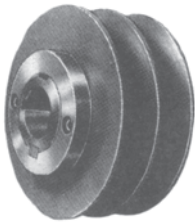

Sheaves for Browning variable speed drives are available in finished bore or bushing types, for use with exclusive split taper design or QD bushings. They're offered in Classical (A-B, C & D), "358" narrow groove, wide range and fractional horsepower types. MVP sheaves are dynamically-balanced to ensure smooth, vibration-free performance. Select from:

- **VL and VM single groove sheaves**, pitch diameter range 1.6 - 4.7", for light duty applications up to 5 HP.
- **VP single and double groove sheaves**, pitch diameter range 3.4 - 7.0", designed for heavier duty service up to 25 HP.
- **Spring-loaded sheaves**, pitch diameter range 1.4 - 5.8", for use with standard fixed pitch sheaves and adjustable motor base; or with *manually controlled* sheaves for a wider range of speeds.
- **LVP single and double groove sheaves**, pitch diameter range 3.4 - 7.0", for heavier duty drives up to 25 HP.
- **MVP multiple groove sheaves** (up to 10 grooves available), pitch diameter range 3.4 - 17.2", for multiple belt drives up to 750 HP.

Locking ring variable speed sheave

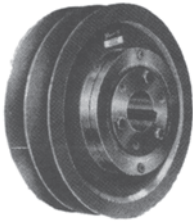

Choose also from a full range of fixed pitch and companion sheaves, V-belts, adjustable motor bases, motors and drivers, to perform almost any power transmission service.

MVP variable speed sheave



MVP companion sheaves

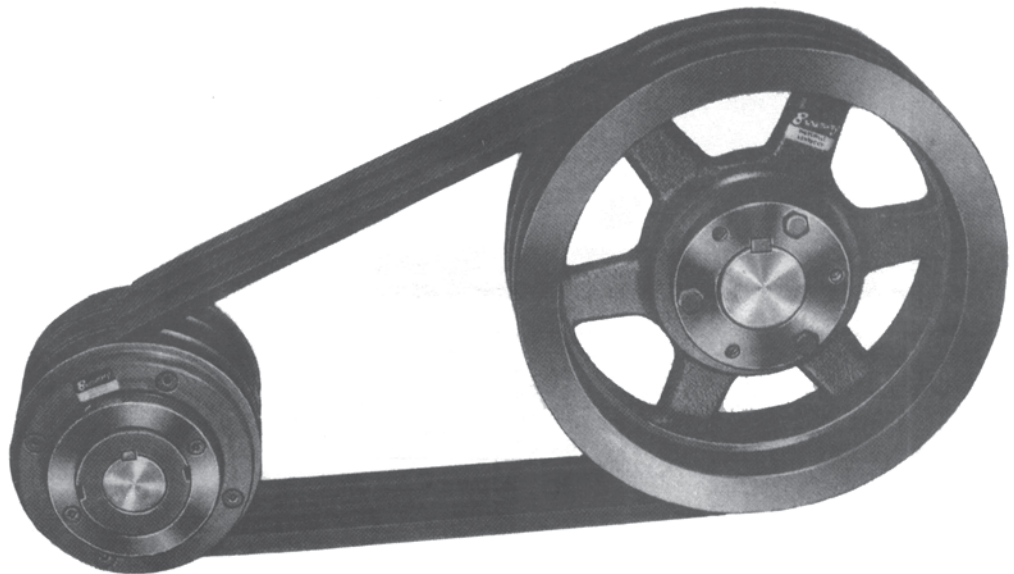

Westward has available a full range of Variable Speed Drives.

Contact your nearest branch for details.

BROWNING VARIABLE SPEED DRIVES

VARIABLE SPEED SHEAVES

Belt Size	Type		No. of Grooves	Pitch Dia. Range	Bore Range
A - B	LVP	Bushing Type	1 - 2	A - 4.2 - 5.2 5.7 - 6.7* B - 4.3 - 5.5 5.8 - 7.0	1/2 - 1 5/8*
		Finished Bore	1 - 2	A - 3.4 - 4.4 5.7 - 6.7 B - 3.7 - 4.7 5.8 - 7.0	7/8 - 1 3/8
	MVP	Bushing Type	2 - 6	A - 5.9 - 7.0 7.9 - 9.0 B - 6.0 - 7.4 8.0 - 9.4	3/4 - 2 5/8
		Finished Bore	2 - 6	A - 3.4 - 4.5 6.9 - 8.0 B - 3.5 - 4.9 7.0 - 8.4	7/8 - 2 1/8
C	MVP	Bushing Type	2 - 4	7.5 - 9.7 11.5 - 13.7	1 - 2 5/8
		Finished Bore	5 - 10	7.5 - 9.7 11.5 - 13.7	1 7/8 - 3 3/8
D	MVP	Finished Bore	3 - 10	12.0 - 15.0 14.0 - 17.0	up to 4 3/4
5V	MVP	Finished Bore	3 - 10*	8.1 - 9.5 11.1 - 12.5	1 7/8 - 3 3/8
8V		Narrow Groove	3 - 10	13.2 - 15.2 15.2 - 17.2	up to 4 3/4

3 Groove is Bushing Type, Bore Range 1 - 2 5/8

EXTENDED HP AND BORE RANGE

5V	2VPA	Finished Bore	5.8 - 7.0 6.2 - 7.4	1 5/8*
	2LVPA		5.8 - 7.4 6.2 - 7.4	
B - 5V	2VPA	Finished Bore	5B - 5.8 - 7.0 6.8 - 8.0	1 5/8
			5V - 6.2 - 7.4 7.2 - 8.4	1 7/8

BROWNING VARIABLE SPEED DRIVES

VARIABLE PITCH SHEAVES

Type			3L	4L or A	5L or B
Single Groove Cast Iron	Finished Bore 1/2 - 7/8*	VL	1.6 - 2.4* 1.6 - 2.7	1.9 - 2.9* 2.8 - 3.8	
		VM		1.9 - 2.9 3.4 - 4.4	2.4 - 3.2* 3.7 - 4.7
	Bushing Type 1/2 - 1 5/8 Bore	1VPA		4.2 - 5.2 5.7 - 6.7	4.3 - 5.5 5.8 - 7.0
	Finished Bore 1/2 - 1 1/8	1VP	1.4 - 2.2 5.1 - 5.9	1.9 - 2.9 5.7 - 6.7	2.4 - 3.2 5.8 - 7.0
Two Groove Cast Iron	Bushing Type 3/4 - 1 5/8 Bore	2VPA		4.2 - 5.2 5.7 - 6.7	4.3 - 5.5 5.8 - 7.0
	Finished Bore 1/2 - 1 1/8	2VP	1.9 - 2.7 5.1 - 5.9	2.0 - 3.0 5.7 - 6.7	2.5 - 3.3 5.8 - 7.0
Spring Loaded Cast Iron 1/2 - 1 bores		SL	1.4 - 2.9 1.9 - 3.6	1.6 - 2.8 4.1 - 5.8	2.2 - 3.7 4.2 - 5.7
Manually Controlled Cast Iron 1/2 - 1 bores		MC	1.4 - 2.9 1.9 - 3.6	1.6 - 2.8 4.1 - 5.8	2.2 - 3.7 4.2 - 5.7

3 Groove is Bushing Type, Bore Range 1 - 2 5/8

COMPANION SHEAVES

A - B	MVP	Bushing Type	3 - 6	A 4.6 - 37.5 B 5.0 - 38.0	1/2 - 3 3/4
C	MVP	Bushing Type	3 - 10	8.0 - 50.0	1 - 7 7/16
D	MVP	Bushing Type	3 - 10	13.0 - 48.0	1 3/8 - 5
5V	MVP	Narrow Groove	3 - 10	7.9 - 49.9	1 1/8 - 5
8V		Bushing Type		13.0 - 52.8	1 11/16 - 7 7/16

BROWNING CAST IRON FHP SHEAVES

Variable Pitch Single Groove Sheaves for "3L", "4L", "5L" Belts

- Low Priced
- Ideal for air movement applications (blowers)
& for changing speeds frequently.

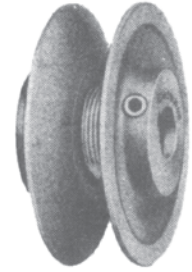

Please specify bore size when ordering.
(i.e. PTP 1VL40-5/8)

PART NO.	O.D.	1/2"	5/8"	3/4"	7/8"	WT.
PTP 1VL25	2.50"	X	X	-	-	.8 lbs.
PTP 1VL30	2.87	X	X	-	-	1.0
PTP 1VL34	3.15	X	X	X	-	1.1
PTP 1VL40	3.75	X	X	X	X	1.3
PTP 1VL44	4.15	X	X	X	X	1.3
PTP 1VM50	4.75	X	X	X	X	2.8

PART NO.	PITCH DIAMETER RANGE											
	"3L" BELTS				"4L" BELTS				"5L" BELTS			
	MIN. PITCH	TURNS OPEN	MAX. PITCH	TURNS OPEN	MIN. PITCH	TURNS OPEN	MAX. PITCH	TURNS OPEN	MIN. PITCH	TURNS OPEN	MAX. PITCH	TURNS OPEN
PTP 1VL25	1.6	4	2.4	0	-	-	-	-	-	-	-	-
PTP 1VL30	1.8	4	2.7	0	-	-	-	-	-	-	-	-
PTP 1VL34	1.7	4	2.5	0	1.9	5	2.9	0	2.4	5	3.2	1
PTP 1VL40	2.3	4	3.1	0	2.4	5	3.4	0	2.7	6	3.7	1
PTP 1VL44	2.7	4	3.5	0	2.8	5	3.8	0	3.1	6	4.1	1
PTP 1VM50	3.3	4	4.1	0	3.4	5	4.4	0	3.7	6	4.7	1



BROWNING 1VP CAST IRON SHEAVES

Single Groove Variable Pitch Sheaves for "3L", "4L", "5L", "A", "B", and "5V" Belts

Stock Sizes - Finished Bore (inches)

PART NO.	TYPE	DIAMETER RANGE																								
		"3L" BELTS				"4L" or "A" BELTS				"5L" or "B" BELTS				"5V" BELTS				STOCK BORES MARKED "X"								
		MIN. PITCH	TURNS OPEN	MAX. PITCH	TURNS OPEN	MIN. DATUM	TURNS OPEN	MAX. DATUM	TURNS OPEN	MIN. DATUM	TURNS OPEN	MAX. DATUM	TURNS OPEN	MIN. PITCH	TURNS OPEN	MAX. PITCH	TURNS OPEN	1/2	5/8	3/4	7/8	1	1 1/8	1 1/4	1 3/8	1 1/2
1VP25	1	1.4	4	2.2	0	-	-	-	-	-	-	-	-	-	-	-	-	X	-	-	-	-	-	-	-	-
1VP30	1	4.8	4	2.7	0	-	-	-	-	-	-	-	-	-	-	-	-	X	X	X	-	-	-	-	-	-
1VP34	1	1.7	4	2.5	0	1.9	5	2.9	0	2.4	5	3.2	1	-	-	-	-	X	X	X	X	-	-	-	-	-
1VP44	1	2.3	4	3.1	0	2.4	5	3.4	0	2.7	6	3.7	1	-	-	-	-	X	X	X	X	-	-	-	-	-
1VP44	1	2.7	4	3.5	0	2.8	5	3.8	0	3.1	6	4.1	1	-	-	-	-	X	X	X	X	-	-	-	-	-
1VP44	2	2.7	4	3.5	0	2.8	5	3.8	0	3.1	6	4.1	1	-	-	-	-	X	X	X	X	-	-	-	-	-
1VP50	1	3.3	4	4.1	0	3.4	5	4.4	0	3.7	6	4.7	1	-	-	-	-	X	X	X	-	-	-	-	-	-
1VP50	2	3.3	4	4.1	0	3.4	5	4.4	0	3.7	6	4.7	1	-	-	-	-	X	X	X	-	-	-	-	-	-
1VP56	1	3.9	4	4.7	0	4.0	5	5.0	0	4.3	6	5.3	1	-	-	-	-	X	X	X	-	-	-	-	-	-
1VP56	2	3.9	4	4.7	0	4.0	5	5.0	0	4.3	6	5.3	1	-	-	-	-	X	X	X	-	-	-	-	-	-
1VP60	2	-	-	-	-	4.2	5	5.2	0	4.3	6	5.5	0	-	-	-	-	-	-	X	X	-	X	-	X	-
1VP60A	3	-	-	-	-	4.2	5	5.2	0	4.3	6	5.5	0	-	-	-	-	-	-	X	X	-	X	-	X	-
1VP62	2	4.5	4	5.3	0	4.6	5	5.6	0	4.9	6	5.9	1	5.3	6	6.3	1	-	X	X	X	X	X	X	X	X
1VP65	2	-	-	-	-	4.7	5	5.7	0	4.8	6	6.0	0	5.2	6	6.4	0	-	-	X	X	-	X	-	X	-
1VP65A	3	-	-	-	-	4.7	5	5.7	0	4.8	6	6.0	0	5.2	6	6.4	0	-	-	X	X	-	X	-	X	-
1VP68	2	5.1	4	5.9	0	5.2	5	6.2	0	5.5	6	6.5	1	5.9	6	6.9	1	-	X	X	X	X	X	X	X	X
1VP71	2	-	-	-	-	5.3	5	6.3	0	5.4	6	6.6	0	5.8	6	7.0	0	-	-	X	X	-	X	-	X	-
1VP71A	3	-	-	-	-	5.3	5	6.3	0	5.4	6	6.6	0	5.8	6	7.0	0	-	-	X	X	-	X	-	X	-
1VP75	2	-	-	-	-	5.7	5	6.7	0	5.8	6	7.0	0	6.2	6	7.4	0	-	-	X	X	-	X	-	X	-
1VP75A	3	-	-	-	-	5.7	5	6.7	0	5.8	6	7.0	0	6.2	6	7.4	0	-	-	X	X	-	X	-	X	-

All fitted with Hollow Head Setscrews

Any standard single groove "O", "A", "B", or "5V" Browning Sheave can be used as a companion sheave.

Type 3 sheaves uses A2 Bushings which have a press fit into the bore of the sheave. See Table No. 4 for available bore sizes.

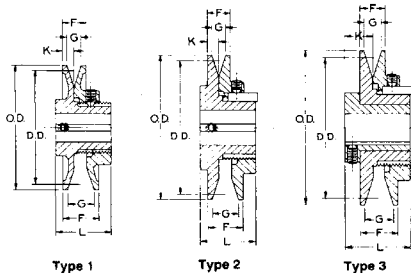

Dimensions (Inches)

PART NO.	TYPE	O.D.	F		G		L	K	WT. LBS.
			MAX.	MIN.	MAX.	MIN.			
1VP25	1	3.32	13/16	9/16	5/8	3/8	1 19/32	5/8	.7
1VP30	1	2.87	13/16	9/16	5/8	3/8	1 21/32	10/32	1.1
1VP34	1	3.15	1	11/16	13/16	1/2	1 7/8	21/32	1.4
1VP40	1	3.75	1 1/16	11/16	7/8	1/2	1 7/8	21/32	1.9
1VP44	1	4.15	1 1/16	11/16	7/8	1/2	1 7/8	21/32	2.4
1VP44	2	4.15	1 1/8	3/4	7/8	1/2	1 7/8	11/16	2.9
1VP50	1	4.75	1 1/16	11/16	7/8	1/2	2	25/32	2.9
1VP50	2	4.75	1 1/8	3/4	7/8	1/2	1 7/8	11/16	3.6
1VP56	1	5.35	1 1/16	11/16	7/8	1/2	1 7/8	21/32	3.8
1VP56	2	5.35	1 1/8	3/4	7/8	1/2	1 7/8	11/16	4.4
1VP60*	2	6.00	1 1/4	7/8	1 1/32	21/32	1 21/32	7/16	6.5
1VP60A	3	6.00	1 1/4	7/8	1 1/32	21/32	2 5/32	15/16	6.3
1VP62*	2	5.95	1 1/8	3/4	7/8	1/2	1 29/32	21/32	6.1
1VP65*	2	6.50	1 1/4	7/8	1 1/32	21/32	1 21/32	7/16	6.8
1VP65A	3	6.50	1 1/4	7/8	1 1/32	21/32	2 5/32	15/16	6.6
1VP68*	2	6.55	1 1/8	3/4	7/8	1/2	1 29/32	21/32	7.3
1VP71*	2	7.10	1 1/4	7/8	1 1/32	21/32	1 21/32	7/16	8.2
1VP71A	3	7.10	1 1/4	7/8	1 1/32	21/32	2 5/32	15/16	8.0
1VP75*	2	7.50	1 1/4	7/8	1 1/32	21/32	1 21/32	7/16	9.2
1VP75A	3	7.50	1 1/4	7/8	1 1/32	21/32	2 5/32	15/16	8.9

*The sheaves have no hub projection.

Bushing Dimension

BUSHING PART NO.	BORE RANGE	L	W	X	Y	Z
A2	1/2 to 1 3/16	1 15/16	1 7/16	2 1/2	1 5/8	1/2
	1 1/4 to 1 9/16	1 15/16	1 1/2	2 1/2	1 5/8	7/16
A3	3/4 to 1 3/16	2 15/16	2 7/16	2 1/2	1 5/8	1/2
	1 1/4 to 1 9/16	2 15/16	2 1/2	2 1/2	1 5/8	7/16

Bushing Bores

BUSHING BORE	A2	A3	BUSHING BORE	A2	A3	BORE RANGE	KEYSEAT
1/2	X	-	1 3/16	X	X	1/2 to 9/16	1/8 to 1/16
5/8	X	-	1 1/4	X	X	5/8 to 7/8	3/16 to 3/32
3/4	X	X	1 5/16	-	X	15/16 to 1 1/4	1/4 to 1/8
7/8	X	X	1 3/8	X	X	1 3/16 to 1 3/8	5/16 to 5/32
15/16	X	X	1 7/16	X	X	1 7/16 to 1 9/16	3/8 to 3/16
1	X	X	1 1/2	X	X		
1 1/16	-	X	1 9/16	-	X		
1 1/8	X	X					

*1 3/8" bore also available with 3/8 x 3/16 keyseat.

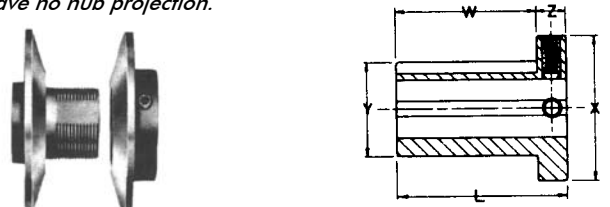

BROWNING 2VP CAST IRON SHEAVES

Single Groove Variable Pitch Sheaves for "3L", "4L", "5L", "A", "B", and "5V" Belts

Stock Sizes - Finished Bore (inches)

PART NO.	TYPE	DIAMETER RANGE																								
		"3L" BELTS				"4L" or "A" BELTS				"5L" or "B" BELTS				"5V" BELTS				STOCK BORES MARKED "X"								
		MIN. PITCH	TURNS OPEN	MAX. PITCH	TURNS OPEN	MIN. DATUM	TURNS OPEN	MAX. DATUM	TURNS OPEN	MIN. DATUM	TURNS OPEN	MAX. DATUM	TURNS OPEN	MIN. PITCH	TURNS OPEN	MAX. PITCH	TURNS OPEN	1/2	5/8	3/4	7/8	1	1 1/8	1 1/4	1 3/8	1 1/2
2VP36	4	1.9	4	2.7	0	2.0	5	3.0	0	2.5	5	3.3	1	-	-	-	-	X	X	X	X	X	-	-	-	-
2VP42	4	2.5	4	3.3	0	2.6	5	3.6	0	2.9	6	3.9	1	-	-	-	-	-	X	X	X	X	X	-	-	-
2VP50	5	3.3	4	4.1	0	3.4	5	4.4	0	3.7	6	4.7	1	-	-	-	-	-	X	X	X	X	X	-	-	-
2VP56	5	3.9	4	4.7	0	4.0	5	5.0	0	4.3	6	5.3	1	-	-	-	-	-	X	X	X	X	X	-	-	-
2VP60	5	-	-	-	-	4.2	5	5.2	0	4.3	6	5.5	0	-	-	-	-	-	-	X	X	-	X	-	X	-
2VP60A	6	-	-	-	-	4.2	5	5.2	0	4.3	6	5.5	0	-	-	-	-	-	-	-	-	-	-	-	-	X
2VP62	5	4.5	4	5.3	0	4.6	5	5.6	0	4.9	6	5.9	1	5.3	6	6.3	1	-	-	X	X	X	X	X	X	-
2VP65	5	-	-	-	-	4.7	5	5.7	0	4.8	6	6.0	0	5.2	6	6.4	0	-	-	X	X	-	X	-	X	-
2VP65A	6	-	-	-	-	4.7	5	5.7	0	4.8	6	6.0	0	5.2	6	6.4	0	-	-	-	-	-	-	-	-	X
2VP68	5	5.1	4	5.9	0	5.2	5	6.2	0	5.5	6	6.5	1	5.9	6	6.9	1	-	-	-	X	X	X	X	X	-
2VP71	5	-	-	-	-	5.3	5	6.3	0	5.4	6	6.6	0	5.8	6	7.0	0	-	-	X	X	-	X	-	X	-
2VP71A	6	-	-	-	-	5.3	5	6.3	0	5.4	6	6.6	0	5.8	6	7.0	0	-	-	-	-	-	-	-	-	X
2VP75	5	-	-	-	-	5.7	5	6.7	0	5.8	6	7.0	0	6.2	6	7.4	0	-	-	X	X	-	X	-	X	-
2VP75A	6	-	-	-	-	5.7	5	6.7	0	5.8	6	7.0	0	6.2	6	7.4	0	-	-	-	-	-	-	-	-	X

All fitted with Hollow Head Setscrews

Any standard single groove "O", "A", "B", or "5V" Browning Sheave can be used as a companion sheave.

Type 3 sheaves uses A2 Bushings which have a press fit into the bore of the sheave. See Table No. 4 for available bore sizes.

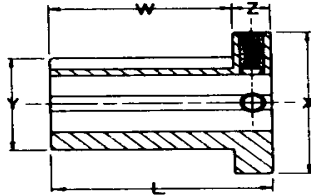

Dimensions (Inches)

PART NO.	TYPE	O.D.	F		G		L	K	WT. LBS.
			MAX.	MIN.	MAX.	MIN.			
2VP36	4	3.35	2	1 3/8	13/16	1/2	3	1 3/16	3.4
2VP42	4	3.95	2 1/8	1 3/8	7/8	1/2	3	1 3/16	4.4
2VP50	5	4.75	2 1/8	1 3/8	7/8	1/2	3	1 3/16	6.3
2VP56	5	5.35	2 1/8	1 3/8	7/8	1/2	3	1 3/16	7.8
2VP60	5	6.00	2 3/8	1 5/8	1/32	21/32	3 1/4	1 1/4	10.6
2VP60A*	6	6.00	2 3/8	1 5/8	1 1/32	21/32	3 3/4	1 3/4	10.4
2VP65	5	6.50	2 3/8	1 5/8	1 1/32	21/32	3 1/4	1 1/4	12.3
2VP65A*	6	6.50	2 3/8	1 5/8	1 1/32	21/32	3 3/4	1 3/4	12.0
2VP68	5	6.55	2 1/8	1 3/8	7/8	1/2	3	1 3/16	11.7
2VP71	5	7.10	2 3/8	1 5/8	1 1/32	21/32	3 1/4	1 1/4	14.6
2VP71A*	6	7.10	2 3/8	1 5/8	1 1/32	21/32	3 3/4	1 3/4	14.4
2VP75	5	7.50	2 3/8	1 5/8	1 1/32	21/32	3 1/4	1 1/4	16.5
2VP75A*	6	7.50	2 3/8	1 5/8	1 1/32	21/32	3 3/4	1 3/4	16.3

Bushing Bores

BORE RANGE	KEYSEAT
1/2	None
5/8 to 7/8	3/16 x 3/32
1 to 1 1/4	1/4 x 1/8
1 3/8	5/16 x 5/32

Please specify bore size when ordering.

*Do not use these sheaves with A3 Bushings on 143T, 145T, 182T or 184T Motors

DIE CAST STANDARD PULLEYS

Single Groove for "A" Belts

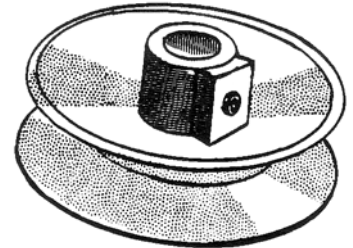
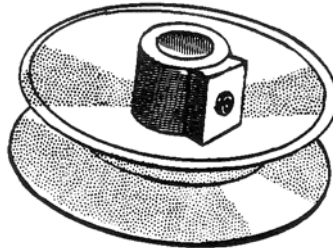
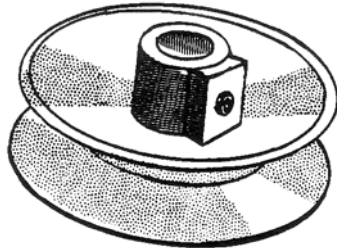

PART NO.	DESCRIPTION	O.D.	PITCH DIA.
PTP A150X1/2	1/2" Pulley	1.50"	1.25"
PTP A150X5/8	5/8" Pulley	1.50	1.25
PTP A200X1/2	1/2" Pulley	2.00	1.75
PTP A200X5/8	5/8" Pulley	2.00	1.75
PTP A200X3/4	3/4" Pulley	2.00	1.75
PTP A225X1/2	1/2" Pulley	2.25	2.00
PTP A225X5/8	5/8" Pulley	2.25	2.00
PTP A225X3/4	3/4" Pulley	2.25	2.00
PTP A250X1/2	1/2" Pulley	2.50	2.25
PTP A250X5/8	5/8" Pulley	2.50	2.25
PTP A250X3/4	3/4" Pulley	2.50	2.25
PTP A300X1/2	1/2" Pulley	3.00	2.75
PTP A300X5/8	5/8" Pulley	3.00	2.75
PTP A300X3/4	3/4" Pulley	3.00	2.75
PTP A350X1/2	1/2" Pulley	3.50	3.25
PTP A350X5/8	5/8" Pulley	3.50	3.25
PTP A350X3/4	3/4" Pulley	3.50	3.25
PTP A400X1/2	1/2" Pulley	4.00	3.75
PTP A400X5/8	5/8" Pulley	4.00	3.75
PTP A400X3/4	3/4" Pulley	4.00	3.75
PTP A450X1/2	1/2" Pulley	4.50	4.25
PTP A450X5/8	5/8" Pulley	4.50	4.25
PTP A450X3/4	3/4" Pulley	4.50	4.25
PTP A500X1/2	1/2" Pulley	5.00	4.75
PTP A500X5/8	5/8" Pulley	5.00	4.75
PTP A500X3/4	3/4" Pulley	5.00	4.75
PTP A600X1/2	1/2" Pulley	6.00	5.75
PTP A600X5/8	5/8" Pulley	6.00	5.75
PTP A600X3/4	3/4" Pulley	6.00	5.75

PART NO.	DESCRIPTION	O.D.	PITCH DIA.
PTP A200X1/2HD	1/2" H.D. Pulley	2.00"	1.75"
PTP A200X5/8HD	5/8" H.D. Pulley	2.00	1.75
PTP A200X3/4HD	3/4" H.D. Pulley	2.00	1.75
PTP A250X1/2HD	1/2" H.D. Pulley	2.50	2.25
PTP A250X5/8HD	5/8" H.D. Pulley	2.50	2.25
PTP A250X3/4HD	3/4" H.D. Pulley	2.50	2.25
PTP A275X1/2HD	1/2" H.D. Pulley	2.75	2.50
PTP A275X5/8HD	5/8" H.D. Pulley	2.75	2.50
PTP A300X1/2HD	1/2" H.D. Pulley	3.00	2.75
PTP A300X5/8HD	5/8" H.D. Pulley	3.00	2.75
PTP A300X3/4HD	3/4" H.D. Pulley	3.00	2.75
PTP A325X5/8HD	5/8" H.D. Pulley	3.25	3.00
PTP A325X3/4HD	3/4" H.D. Pulley	3.25	3.00
PTP A350X1/2HD	1/2" H.D. Pulley	3.50	3.25
PTP A350X5/8HD	5/8" H.D. Pulley	3.50	3.25
PTP A350X3/4HD	3/4" H.D. Pulley	3.50	3.25
PTP A400X1/2HD	1/2" H.D. Pulley	4.00	3.75
PTP A400X5/8HD	5/8" H.D. Pulley	4.00	3.75
PTP A400X3/4HD	3/4" H.D. Pulley	4.00	3.75
PTP A450X1/2HD	1/2" H.D. Pulley	4.50	4.25
PTP A450X5/8HD	5/8" H.D. Pulley	4.50	4.25
PTP A450X3/4HD	3/4" H.D. Pulley	4.50	4.25
PTP A500X1/2HD	1/2" H.D. Pulley	5.00	4.75
PTP A500X5/8HD	5/8" H.D. Pulley	5.00	4.75
PTP A500X3/4HD	3/4" H.D. Pulley	5.00	4.75
PTP A600X1/2HD	1/2" H.D. Pulley	6.00	5.75
PTP A600X5/8HD	5/8" H.D. Pulley	6.00	5.75
PTP A600X3/4HD	3/4" H.D. Pulley	6.00	5.75

NOTE: Not supplied with set screw.

DIE CAST SPOKE PULLEYS

Single Groove for "A" or "B" Belts

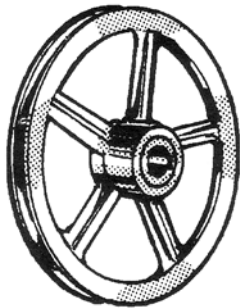
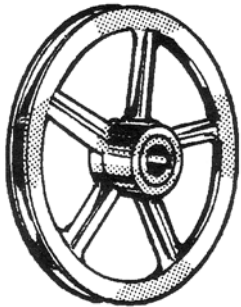

PART NO.	DESCRIPTION	O.D.	PITCH DIA.
PTP AB700X1/2	1/2" Spoke Pulley	7.00	6.75
PTP AB700X5/8	5/8" Spoke Pulley	7.00	6.75
PTP AB700X3/4	3/4" Spoke Pulley	7.00	6.75
PTP AB800X1/2	1/2" Spoke Pulley	8.00	7.75
PTP AB800X5/8	5/8" Spoke Pulley	8.00	7.75
PTP AB800X3/4	3/4" Spoke Pulley	8.00	7.75
PTP AB900X1/2	1/2" Spoke Pulley	9.00	8.75
PTP AB900X5/8	5/8" Spoke Pulley	9.00	8.75
PTP AB900X3/4	3/4" Spoke Pulley	9.00	8.75
PTP AB900X1	1" Spoke Pulley	9.00	8.75
PTP AB1000X1/2	1/2" Spoke Pulley	10.00	9.75
PTP AB1000X5/8	5/8" Spoke Pulley	10.00	9.75
PTP AB1000X3/4	3/4" Spoke Pulley	10.00	9.75
PTP AB1000X7/8	7/8" Spoke Pulley	10.00	9.75
PTP AB1000X1	1" Spoke Pulley	10.00	9.75
PTP AB1200X1/2	1/2" Spoke Pulley	12.00	11.75
PTP AB1200X5/8	5/8" Spoke Pulley	12.00	11.75
PTP AB1200X3/4	3/4" Spoke Pulley	12.00	11.75
PTP AB1200X7/8	7/8" Spoke Pulley	12.00	11.75
PTP AB1200X1	1" Spoke Pulley	12.00	11.75

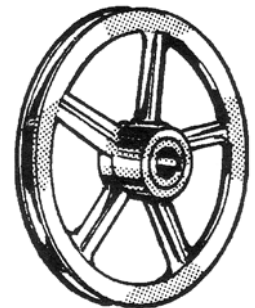
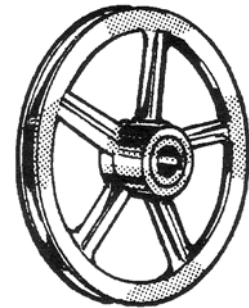

DIE CAST STEP PULLEYS

For "A" or "B" Belts

PART NO.	DESCRIPTION	OUTSIDE DIAMETER			
		1ST	2ND	3RD	4TH
PTP SP300X1/2-2	1/2" 2 Step Pulley	2"	3"	-	-
PTP SP300X5/8-2	5/8" 2 Step Pulley	2	3	-	-
PTP SP350X1/2-3	1/2" 3 Step Pulley	1 3/4	2 5/8	3 1/2"	-
PTP SP350X5/8-3	5/8" 3 Step Pulley	1 3/4	2 5/8	3 1/2	-
PTP SP350X3/4-3	3/4" 3 Step Pulley	1 3/4	2 5/8	3 1/2	-
PTP SP400X1/2-4	1/2" 4 Step Pulley	2	2 3/4	3 1/2	4 1/4"
PTP SP400X5/8-4	5/8" 4 Step Pulley	2	2 3/4	3 1/2	4 1/4
PTP SP400X3/4-4	3/4" 4 Step Pulley	2	2 3/4	3 1/2	4 1/4
PTP SP400X7/8-4	7/8" 4 Step Pulley	2	2 3/4	3 1/2	4 1/4
PTP SP500X1/2-4	1/2" 4 Step Pulley	2	3	4	5
PTP SP500X5/8-4	5/8" 4 Step Pulley	2	3	4	5
PTP SP500X3/4-4	3/4" 4 Step Pulley	2	3	4	5

NOTE: Not supplied with set screw.

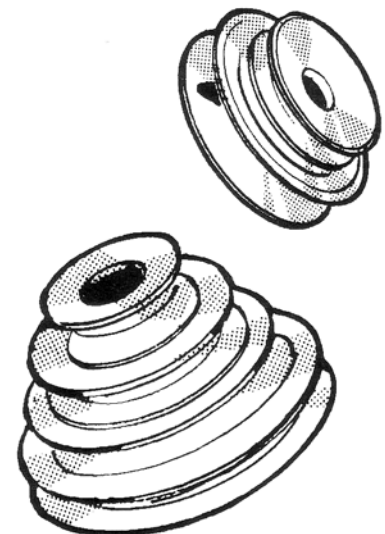

Die Cast Pulleys...For Light Duty Applications

DIE CAST PULLEYS AND HARDWARE DISPLAY BOARD

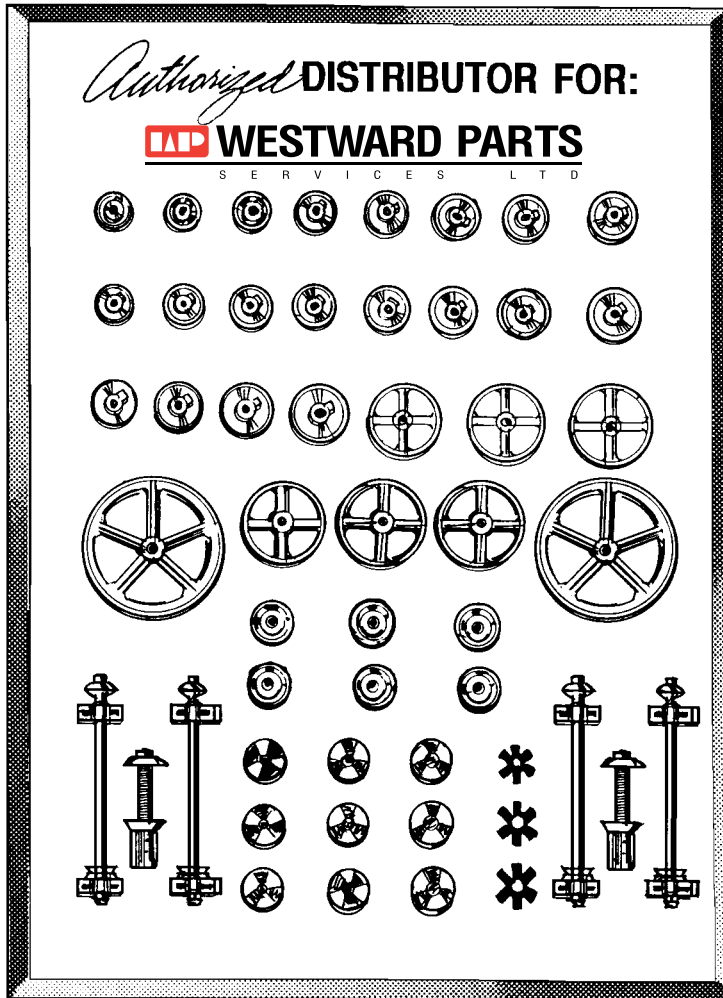

Assortment Includes:

- 56 of the most popular die cast aluminum sheaves
- 6 of the most popular cast variable speed sheaves
- 18 of the most popular jaw type coupling halves and inserts
- 6 of the most popular mandrels
- Attractive display board 36" x 48"

PART NO.
PTP #4000

- Increase Profits -
- Increase Sales -



Body



Spider

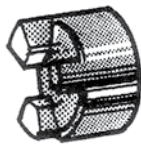

Body

See Page 102 for a Range of Flexible Shaft Couplings

INTERCHANGE INFORMATION

Pulleys

PART NO.	HARDWARE PART NO.	WILL INTERCHANGE WITH DYNALINE PART NO.	PART NO.	HARDWARE PART NO.	WILL INTERCHANGE WITH DYNALINE PART NO.
PTP A150X1/2	4000	55400	PTP A700X5/8	4401	55430
PTP A150X5/8	4001	55401	PTP A700X3/4	4402	55431
PTP A200X1/2	4010	55402	PTP AB800X1/2	4410	55432
PTP A200X5/8	4011	55403	PTP AB800X5/8	4411	55433
PTP A200X3/4	4012	55404	PTP AB800X3/4	4412	55434
PTP A225X1/2	4020	55405	PTP AB900X1/2	4420	55435
PTP A225X5/8	4021	55406	PTP AB900X5/8	4421	55436
PTP A225X3/4	4022	55407	PTP AB900X3/4	4422	55437
PTP A250X1/2	4030	55408	PTP AB1000X1/2	4450	55438
PTP A250X5/8	4031	55409	PTP AB1000X5/8	4451	55439
PTP A250X3/4	4032	55410	PTP AB1000X3/4	4452	55440
PTP A300X1/2	4040	55411	PTP AB1000X7/8	4453	55441
PTP A300X5/8	4041	55412	PTP AB1000X1	4454	55442
PTP A300X3/4	4042	55413	PTP AB1200X1/2	4460	55443
PTP A350X1/2	4050	55414	PTP AB1200X5/8	4461	55444
PTP A350X5/8	4051	55415	PTP AB1200X3/4	4462	55445
PTP A350X3/4	4052	55416	PTP AB1200X7/8	4463	55446
PTP A400X1/2	4060	55417	PTP AB1200X1	4464	55447
PTP A400X5/8	4061	55418	PTP SP300X1/2	4700	-
PTP A40X3/4	4062	55419	PTP SP300X5/8-2	4701	-
PTP A450X1/2	4070	55420	PTP SP350X1/2-3	4720	55470
PTP A450X5/8	4071	55421	PTP SP350X5/8-3	4721	55471
PTP A450X3/4	4072	55422	PTP SP350X3/4-3	4722	55472
PTP A500X1/2	4080	55423	PTP SP400X1/2-4	4740	55473
PTP A500X5/8	4081	55424	PTP SP400X5/8-4	4741	55474
PTP A500X3/4	4082	55425	PTP SP400X3/4-4	4742	55475
PTP A600X1/2	4090	55426	PTP SP400X7/8-4	4743	-
PTP A600X5/8	4091	55427	PTP SP500X1/2-4	4750	55476
PTP A600X3/4	4092	55428	PTP SP500X5/8-4	4751	55477
PTP AB700X1/2	4400	55429	PTP SP500X3/4-4	4752	55478

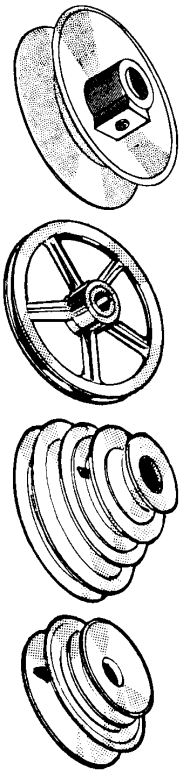

Mandrels

PART NO.	DESCRIPTION	NATIONAL HARDWARE PART NO.	WILL INTERCHANGE WITH DYNALINE PART NO.
PTP 4860	Stub Mandrel x 1/2"	4860	55493
PTP 4870	Stub Mandrel x 5/8"	4870	55494
PTP 4800	General Purpose Saw Mandrel 1/2"	4800	55495
PTP 4810	General Purpose Saw Mandrel 5/8"	4810	55496
PTP 4840	General Purpose Grinder Mandrel 1/2"	4840	55497
PTP 4850	General Purpose Grinder Mandrel 5/8"	4850	55498

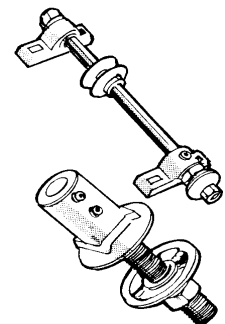

MANDRELS

Stub Mandrel

Die cast zinc with cast in 1/2" diameter threaded steel shaft, complete with adjusting nut, flange, and two set screws.

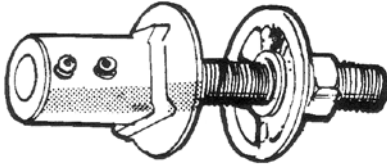

PART NO.	DESCRIPTION
PTP 4860	To fit 1/2" diameter motor shaft
PTP 4870	To fit 5/8" diameter motor shaft

General Purpose Saw Mandrels

Zinc die case, with oilless bronze bushings, complete with 2" SINGLE GROOVE V PULLEY. Painted shaft bearings. Accurately machined 12", steel shaft and flanges.

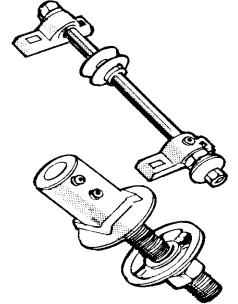

PART NO.	DESCRIPTION
PTP 4800	Turned down at one end to 1/2". Takes saw with 1/2" bore.
PTP 4810	Takes saw with 5/8" bore.

General Purpose Grinder Mandrels

Zinc die cast, with oilless bronze bushings, complete with 2" SINGLE GROOVE V PULLEY. Painted shaft bearings. Accurately machined 14", 5/8" diameter Steel Shaft and Flanges. Right hand thread on one end; left hand thread on other end. A sturdy and useful mandrel allowing an operation on each end without changing.

PART NO.	DESCRIPTION
PTP 4840	Turned down at both ends to 1/2" diameter. Takes grinder, buff, etc. with 1/2" bore.
PTP 4850	Takes grinder, buff, etc. with 5/8" bore.

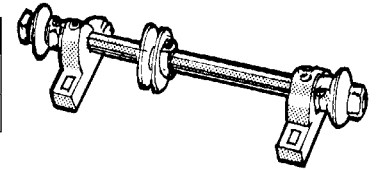

Heavy Duty Mandrels

Precision Ball Bearing Mandrels for Heavy Duty Continuous Service. The mandrels are of modern design throughout and combine quality with the most contemporary appearance. Particular attention should be paid to the following features:

- Sealed Ball Bearings. No greasing necessary. No danger of bearings loading up with dust or dirt.
- Heavy cast saw flange.
- Permanent factory assembly. No adjustment required.
- Bolt locations for easy access.
- Available in either 1/2" or 5/8" size with righthand thread.
- Precise workmanship.
- Painted finish.
- Attractive appearance.
- Individually boxed.

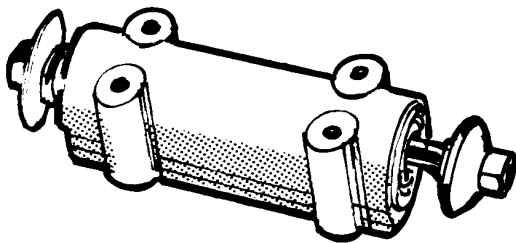

PART NO.	DESCRIPTION
PTP 4820	1/2" shaft - right hand thread
PTP 4830	5/8" shaft - right hand thread

BROWNING SYNCHRONOUS BELT DRIVE SHEAVES

Combining the positive timing action of gears with the flexibility, speed and low noise level of belts.

Browning now offers two expanded and enhanced synchronous belt drive lines to add to the most extensive belt drive line available anywhere. These new lines - which serve applications up to 600 HP - include the HPT High Performance Timing drive line and many additional sizes of the proven Browning Gearbelt Drive Line. Added selections include double Gearbelts which furnish a variety of design solutions for changing shaft rotation.

Synchronous Belt Drives eliminate the problems of slip-page, belt stretch, lubrication and metal-to-metal contact; they provide superior performance because power is transmitted by positive engagement of belt teeth rather than by friction as in conventional belt drives.

Westward has available a full range of Browning timing belt drives. Contact your nearest branch for details.

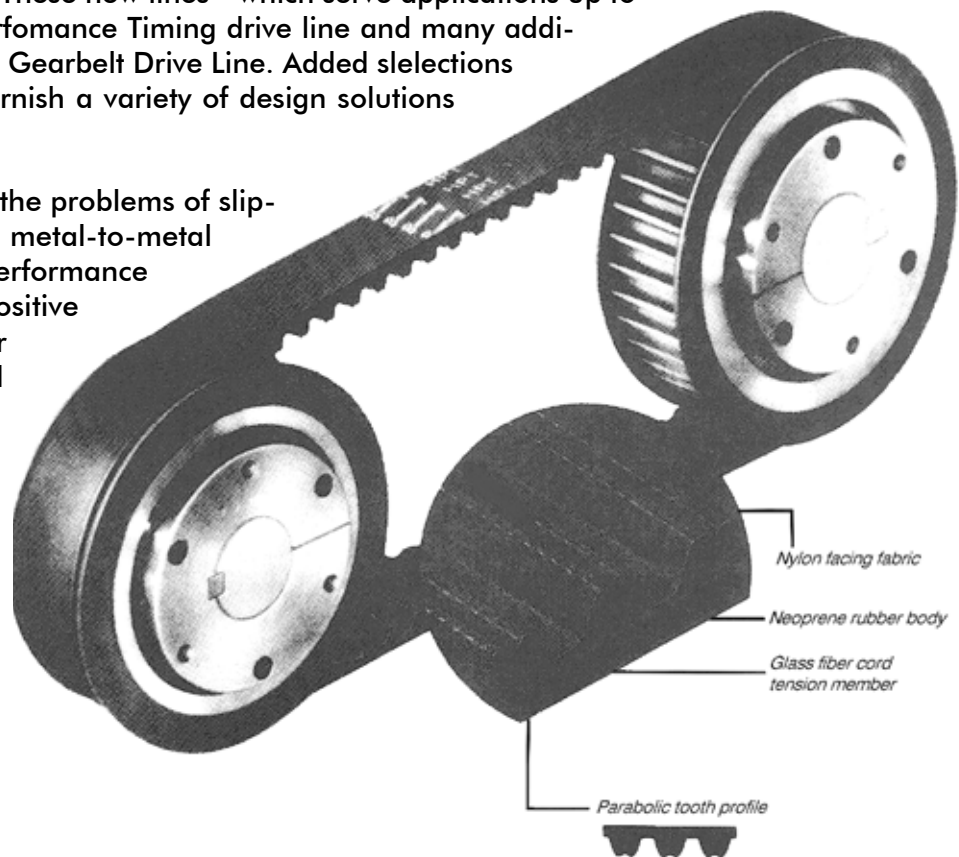

SPROCKETS			BELTS	
PITCH	GROOVES	BORE RANGE	WIDTH	LENGTH
8 mm	22-192	1/2 - 3 1/2	20, 30, 50, 85 mm	480 - 4400 mm
14 mm	28-216	1/2 - 5 1/2	40, 55, 85, 115, 170 mm	966 - 6860 mm

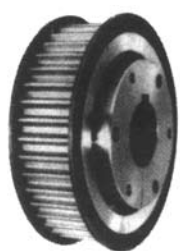

HPT Sprocket

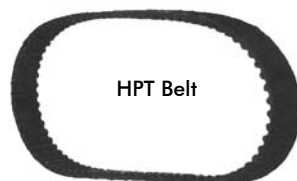

HPT Belt

HPT Drives offer a wide range of HP and speeds, from very low speeds - 10 RPM or less - to high speeds well over 5,000 RPM and horsepower ratings from fractional to more than 200 HP. Features and benefits include:

- significantly quieter operation
- new parabolic tooth profile
- glass fiber cord tension member
- neoprene rubber body
- nylon facing fabric
- positive drive, no slip
- lower belt tensions
- no lubrication required
- fully interchangeable with competitive types

BROWNING SYNCHRONOUS BELT DRIVES

Gearbelt Drives are offered in five stock pitches to handle a wide range of loads, speeds and applications. Advantages include:

- **Constant speed** - no slip, no creep, minimum backlash, because of the positive grip of the belt teeth with pulley grooves.
- **High modulus strength member** - needs minimum take-up.
- **Freedom from initial belt tension** - reduces bearing loads, increases life.
- **Compact design** - gearbelts permit smaller pulleys, shorter centers, narrower belts.
- **Lightweight** - high horsepower-to-weight ratio makes gearbelt drives ideal for any application where weight is an important factor.
- **Less Heat** - because gearbelt drives generate virtually no friction!
- **No lubrication required.**
- **Wide load capacity range.**
- **Wide belt speed range.**

Both HPT and Gearbelt Drives offer a choice of the popular Browning split taper bushing or QD bushing for sprocket/pulleys.

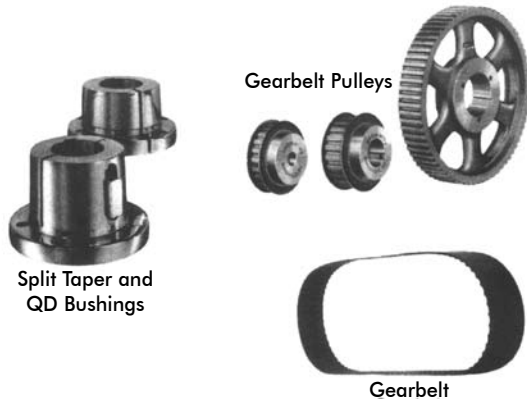
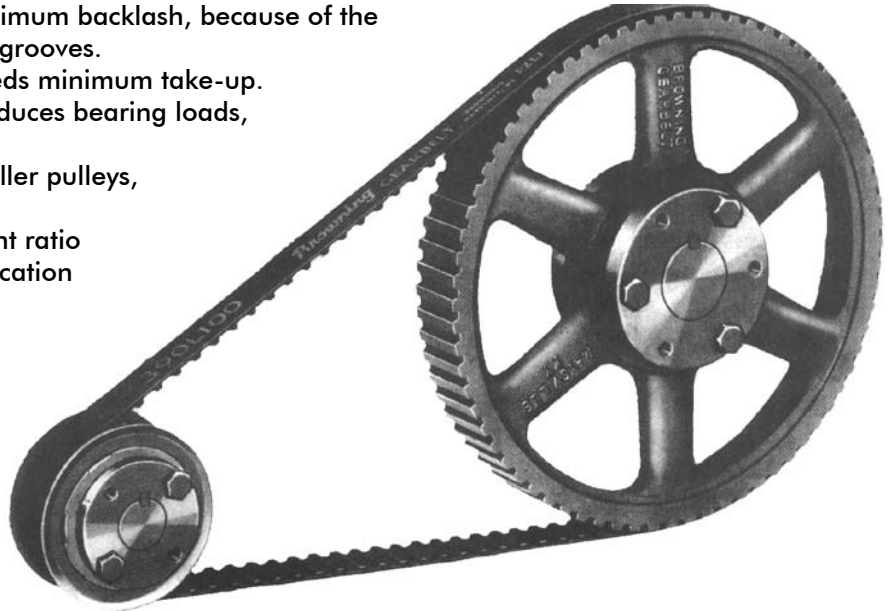

Gearbelt Drives

Pitch	Gearbelt Pulleys		Gearbelts		
	Grooves	Bore Range*	Belt Width	Pitch Length	No. Teeth
XL	1/5"	10 - 72	MB 3/16" - 1"	6.0" - 26.0"	30 - 130
L	3/8"	10 - 17	FB 3/8" - 1"	1/2" - 3/4" - 1**	33 - 160
		18 - 40	MB 1/2" - 2 3/8"		
H	1/2"	18 - 120	3/8" - 1 3/4"	24.0 - 170.0	48 - 340
		14 - 30	MB 5/8" - 2 3/8"		
XH	7/8"	14 - 156	3/8" - 3 3/4"	50.75 - 175.0	58 - 200
		18 - 26	MB 1 - 3 3/4"		
XXH	1 1/4"	18 - 120	3/4" - 4 1/4"	70.0 - 180.0	56 - 144
		18 - 90	1 1/8" - 5"		

* MB = Minimum Bore. FB = Finished Bore. Others are bushing type.

** Double Gearbelts available in XL, L & H sizes.

BROWNING POLY-V DRIVES

All the advantages of V-Belts combines with the simplicity of flat belts.

Browning Poly-V drives provide the best of all power transmission combinations: the superior driving force of multiple V-belts without the matching problems associated with individual belts.

Poly-V drives pack more power in the same space...or the same power in less space. **They deliver up to 30 - 50% more power than conventional V-belt assemblies of equal size.** They can provide increased drive capacity when additional sheave width is not practical, or allow the use of narrower sheaves to furnish the same power output with a more compact drive. This also lessens drive weight, and can increase equipment life and reduce downtime.

A Poly-V belt is a single integrated assembly that provides even load distribution and uniform length of the individual belt segments. The one-piece design eliminated the close matching of individual belts that's required for optimum performance.

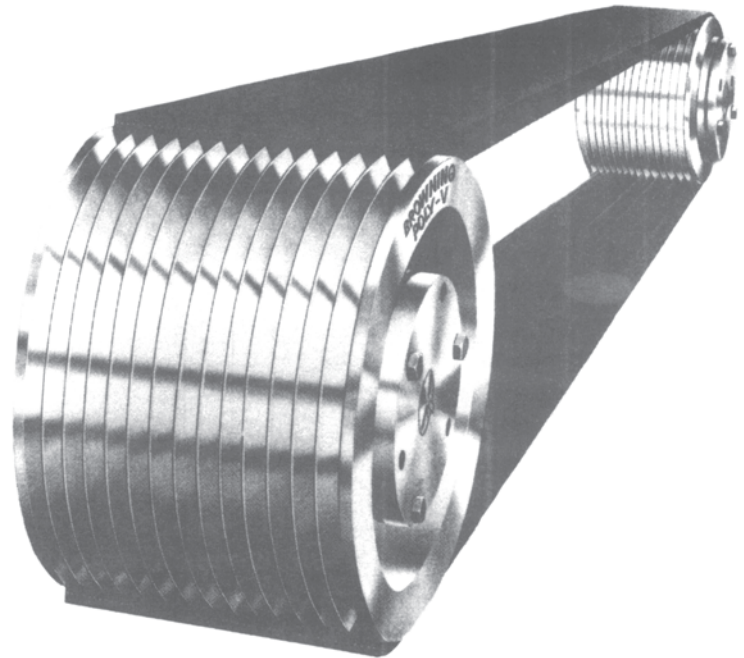

Poly-V Drives

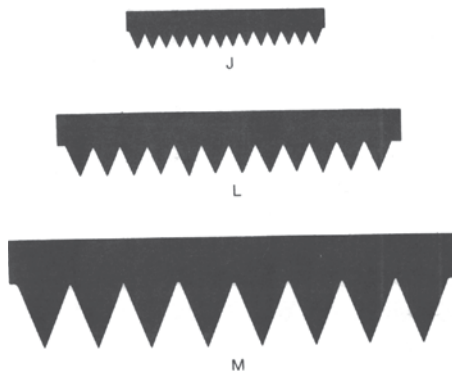

Cross Section		No. of Grooves	Pitch Diameter	Bore Range*	Belt Pitch Lengths
J	3/32" Rib Spacing	4, 6	1.25 - 1.90"	FB 3/8" - 1"	18.0 - 98.0"
		4, 6 10, 16	2.00 - 10.60"	3/8" - 2 11/16"	
L	3/16" Rib Spacing	6, 8, 10, 12, 14, 16, 20	3.00 - 30.00	1/2" - 3 3/4"	50.0 - 145.5
M	3/8" Rib Spacing	6, 8, 10, 12, 14, 16, 20	7.00 - 44.00	3/4" - 4 1/4"	90.0 - 198.0

*FB = Finished Bore. Others are bushing type.

Poly-V is a registered trademark of Goodyear Tire & Rubber Co.

Westward has available a full range of Poly-V drives. Contact your nearest branch for details.

STEEL WIRE ROPE PULLEYS

2" to 4" Outside Diameter

Pulleys are furnished with a 7/8" stock bore to receive a press fit on the 7/8" O.D. powdered metal bushing sizes. Pulleys and bushings should be ordered separately by part number.

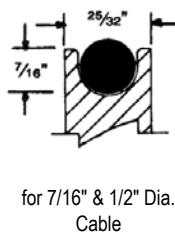
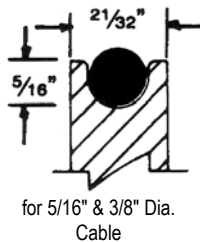
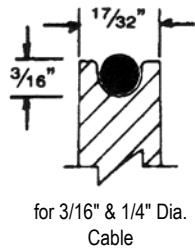
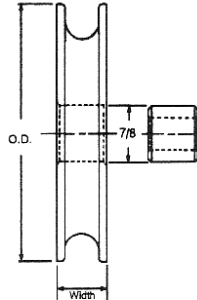

Pulleys

PART NO.	O.D.	WIDTH	APPROX. WT.
PTP 150-3217	2"	17/32"	.32 lb.
PTP 150-3221	2"	21/32"	.32 lb.
PTP 150-3225	2"	25/32"	.25 lb.
PTP 150-4817	3"	17/32"	.88 lb.
PTP 150-4821	3"	21/32"	.94 lb.
PTP 150-4825	3"	25/32"	.94 lb.
PTP 150-6417	4"	17/32"	1.69 lb.
PTP 150-6421	4"	21/32"	1.83 lb.
PTP 150-6425	4"	25/32"	2.00 lb.

Powdered Metal Bushings

PART NO.	O.D.	I.D.	WIDTH	APPROX. WT.
PTP 151-0817	7/8"	1/2"	17/32"	.06 lb.
PTP 151-1017	7/8"	5/8"	17/32"	.05 lb.
PTP 151-1217	7/8"	3/4"	17/32"	.02 lb.
PTP 151-0821	7/8"	1/2"	21/32"	.05 lb.
PTP 151-1021	7/8"	5/8"	21/32"	.04 lb.
PTP 151-1221	7/8"	3/4"	21/32"	.03 lb.
PTP 151-0825	7/8"	1/2"	25/32"	.07 lb.
PTP 151-1025	7/8"	5/8"	25/32"	.05 lb.
PTP 151-1225	7/8"	3/4"	25/32"	.03 lb.

5" to 10" Outside Diameter

Pulleys are furnished with a 1 1/4" stock bore to receive a press fit on the 1 1/4" O.D. powdered metal bushing sizes. Pulleys and bushings should be ordered separately by part number.

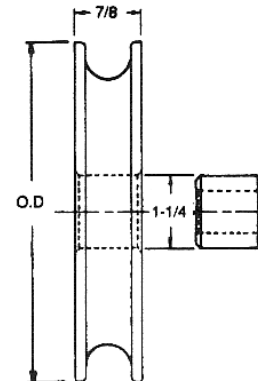

Pulleys

PART NO.	O.D.	CABLE SIZE	APPROX. WT.
PTP 150-8006	5"	5/16" & 3/8"	3.94 lb.
PTP 150-8008	5"	7/16" & 1/2"	3.56 lb.
PTP 150-9606	6"	5/16" & 3/8"	6.00 lb.
PTP 150-9608	6"	7/16" & 1/2"	5.63 lb.
PTP 150-11208	7"	7/16" & 1/2"	7.50 lb.
PTP 150-12808	8"	7/16" & 1/2"	10.50 lb.
PTP 150-14408	9"	7/16" & 1/2"	13.00 lb.
PTP 150-16008	10"	7/16" & 1/2"	16.50 lb.

Powdered Metal Bushings

PART NO.	O.D.	I.D.	WIDTH	APPROX. WT.
PTP 151-1214	1 1/4"	3/4"	7/8"	.15 lb.
PTP 151-1414	1 1/4"	7/8"	7/8"	.13 lb.
PTP 151-1614	1 1/4"	1"	7/8"	.08 lb.
PTP 151-1814	1 1/4"	1 1/8"	7/8"	.04 lb.

WELD-ON PULLEYS

Single Groove Fits A or B Width V-Belts

Fits V Series Hub (1 1/8")

PART NO.	O.D.
PTP 21010025	2 1/2"
PTP 21010030	3"
PTP 21010035	3 1/2"

Fits W Series Hub (1 5/8")

PART NO.	O.D.
PTP 21020035	3 1/2"
PTP 21020040	4"
PTP 21020045	4 1/2"
PTP 21020050	5"
PTP 21020055	5 1/2"
PTP 21020060	6"
PTP 21020065	6 1/2"
PTP 21020070	7"
PTP 21020080	8"
PTP 21020090	9"
PTP 21020100	10"
PTP 21020110	11"
PTP 21020120	12"
PTP 21020140	14"
PTP 21020160	16"

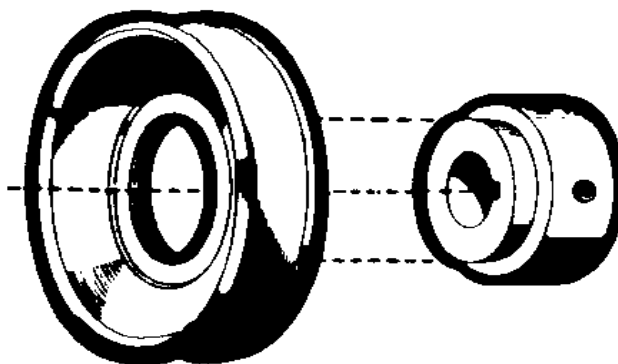

Single Groove Fits C Width V-Belts

Fits X Series Hub (2")

PART NO.	O.D.
PTP W600C	6"
PTP W800C	8"
PTP W1000C	10"
PTP W1200C	12"

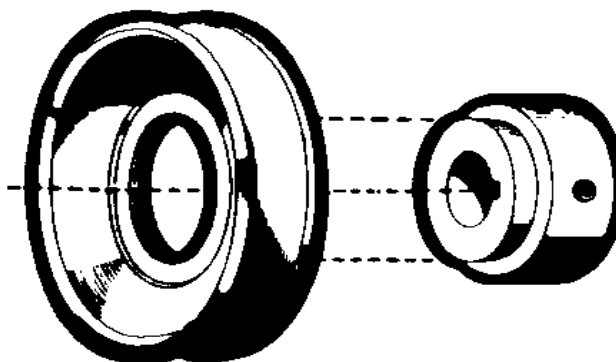

WELD-ON HUBS

Round Bore

PART NO.	BORE SIZE
PTP 10008V	1/2"
PTP 10009V	9/16"
PTP 10010V	5/8"
PTP 10011V	11/16"
PTP 10012V	3/4"
PTP 10013V	13/16"
PTP 10014V	7/8"
PTP 20008W	1/2"
PTP 20009W	9/16"
PTP 20010W	5/8"
PTP 20011W	11/16"
PTP 20012W	3/4"
PTP 20013W	13/16"
PTP 20014W	7/8"
PTP 20015W	15/16"
PTP 20016W	1"
PTP 20017W	1 1/16"

PART NO.	BORE SIZE
PTP 20018W	1 1/8"
PTP 20019W	1 3/16"
PTP 20020W	1 1/4"
PTP 20021W	1 5/16"
PTP 30010X	5/8"
PTP 30011X	11/16"
PTP 30012X	3/4"
PTP 30013X	13/16"
PTP 30014X	7/8"
PTP 30015X	15/16"
PTP 30016X	1"
PTP 30017X	1 1/16"
PTP 30018X	1 1/8"
PTP 30019X	1 3/16"
PTP 30020X	1 1/4"
PTP 30021X	1 5/16"
PTP 30022X	1 3/8"

PART NO.	BORE SIZE
PTP 30023X	1 7/16"
PTP 30024X	1 1/2"
PTP 50016Y	1"
PTP 50017Y	1 1/16"
PTP 50018Y	1 1/8"
PTP 50019Y	1 3/16"
PTP 50020Y	1 1/4"
PTP 50021Y	1 5/16"
PTP 50022Y	1 3/8"
PTP 50023Y	1 7/16"
PTP 50024Y	1 1/2"
PTP 50026Y	1 5/8"
PTP 50027Y	1 11/16"
PTP 50028Y	1 3/4"
PTP 50030Y	1 7/8"
PTP 50031Y	1 15/16"
PTP 50032Y	2"

Spline Bore

PART NO.	BORE SIZE
PTP 21413W	7/8" x 13 SP
PTP 21606W	1" x 6 SP
PTP 21610W	1" x 10 SP
PTP 21615W	1" x 15 SP
PTP 21806W	1 1/8" x 6 SP
PTP 22006W	1 1/4" x 6 SP
PTP 22014W	1 1/4" x 14 SP
PTP 22206W	1 3/8" x 6 SP
PTP 22210W	1 3/8" x 10 SP
PTP 22221W	1 3/8" x 21 SP
PTP 31413X	7/8" x 13 SP
PTP 31606X	1" x 6 SP
PTP 31610X	1" x 10 SP
PTP 31615X	1" x 15 SP
PTP 31806X	1 1/8" x 6 SP
PTP 32006X	1 1/4" x 6 SP
PTP 32014X	1 1/4" x 14 SP
PTP 32206X	1 3/8" x 6 SP
PTP 32210X	1 3/8" x 10 SP
PTP 32221X	1 3/8" x 21 SP
PTP 32410X	1 1/2" x 10 SP
PTP 32806X	1 3/4" x 6 SP

Square Bore

PART NO.	BORE SIZE
PTP 2S010S	5/8"
PTP 2S012W	3/4"
PTP 2S014W	7/8"
PTP 2S016W	1"
PTP 3S010X	5/8"
PTP 3S012X	3/4"
PTP 3S014X	7/8"
PTP 3S015X	15/16"
PTP 3S016X	1"
PTP 3S018X	1 1/8"
PTP 3S019X	1 3/16"
PTP 3S020X	1 1/4"

Hexagon Bore

PART NO.	BORE SIZE
PTP 2H010W	5/8"
PTP 2H012W	3/4"
PTP 2H014W	7/8"
PTP 2H016W	1"
PTP 2H018W	1 1/8"
PTP 2H020W	1 1/4"
PTP 3H010X	5/8"
PTP 3H012X	3/4"
PTP 3H014X	7/8"
PTP 3H016X	1"
PTP 3H018X	1 1/8"

Note: A Low Hydrogen Electrode is recommended for welding hub to sprockets or pulleys.

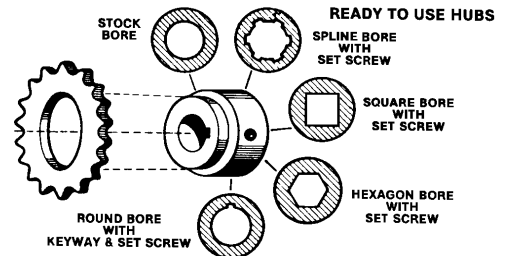

See page 3-51 for idler style weld-on hubs.

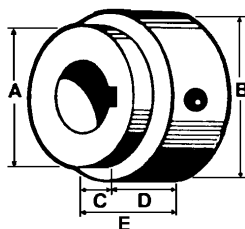

Hub Dimensions

	A	B	C	D	E
V-SERIES HUBS - To fit V Type Sprockets	1 1/8"	1 7/16"	7/16"	3/4"	1 3/16"
W-SERIES HUBS - To fit W Type Sprockets	1 5/8"	1 13/16"	7/16"	1"	1 7/16"
X-SERIES HUBS - To fit X Type Sprockets	2"	2 1/2"	7/16"	1"	1 7/16"
Y-SERIES HUBS - To fit Y Type Sprockets	2 3/4"	3 3/4"	11/16"	1 3/16"	1 7/8"

IDLER WELD HUBS

For a quick idler application: Pick the appropriate Sprocket or Pulley and then pick the corresponding Idler Hub.

Idler Hubs machined to eliminate special fixtures. Simply clamp idler hub to sprocket or pulley and weld.

Three sizes available to fit W, X & Y Series weld-on sprockets & pulleys.

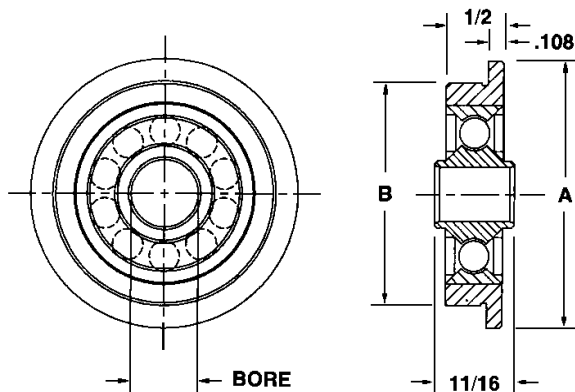

PART NO.	FITS SERIES	DIMENSIONS	
		A	B
PTP 23010W	W	1 ¹³ / ₁₆ "	1 ⁵ / ₈ "
PTP 33010X	X	2 ¹ / ₄ "	2"

W & X Idler Hubs available in ⁵/₈" I.D. Bores
Packaged with ¹/₂" I.D. Reducer Bushing

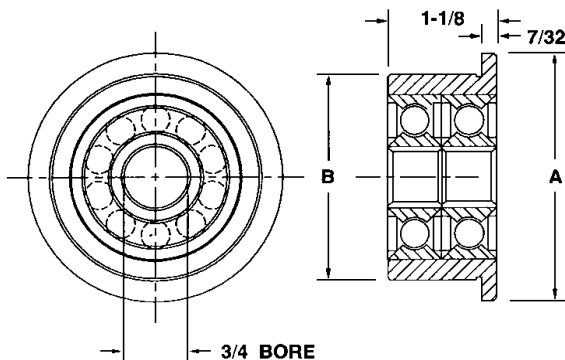

PART NO.	FITS SERIES	DIMENSIONS	
		A	B
PTP 53012Y	Y	3"	2 ³ / ₄ "

Y Hub is ³/₄" Bore.

COUPLER HUBS

Coupler Hubs are designed to connect two separate shafts of the same OR different sizes.

PART NO.	FITS HUB SERIES	DIM. A THRU BORE	DIM. B O.D.	DIM. C I.D.	APPROX WEIGHT
PTP W3226	W	1"	2"	1 ⁵ / ₈ "	.32 lbs.
PTP X4032	X	1"	2 ¹ / ₂ "	2"	.50 lbs.

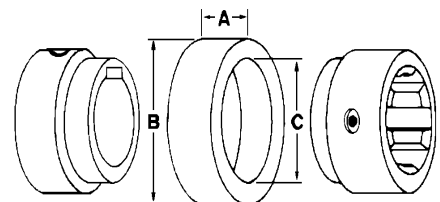

AETNA IDLERS

Flanged Flat Belt

PART NO.	O.D. (D)	P.D. (C)	BORE (A)	FLANGE WIDTH (E)	HUB WIDTH (H)	BELT SIZE
PTP AG2362A	3 1/2"	2 3/4"	1/2"	1 1/2"	1.125	A-B-C-D
PTP AG2362S	3 1/2"	2 3/4"	5/8"	1 1/2"	1.125	A-B-C-D
PTP AG2352A	3 1/4"	2 7/8"	1/2"	1 1/16"	.750	A-B
PTP AG2352	3 1/4"	2 7/8"	5/8"	1 1/16"	.750	A-B
PTP AG2366AS	3 1/4"	2 7/8"	1/2"	1 1/16"	1.125	A-B
PTP AG2413A	4 29/64"	4"	1/2"	1 1/8"	.927	A-B-C
PTP AG2413	4 29/64"	4"	5/8"	1 1/8"	.927	A-B-C
PTP AG2413AP	4 29/64"	4"	1/2"	1 1/8"	1.125	A-B-C
PTP AG2452A	4 5/8"	4 1/4"	1/2"	3/4"	.927	A-B
PTP AG2452	4 5/8"	4 1/4"	5/8"	3/4"	.927	A-B
PTP AG2613A	7"	6"	1/2"	1"	.927	A-B-C
PTP AG2613	7"	6"	5/8"	1"	.927	A-B-C
PTP AG2814A	8 3/4"	8"	1/2"	1 1/8"	.927	A-B-C
PTP AG2814	8 3/4"	8"	5/8"	1 1/8"	.927	A-B-C

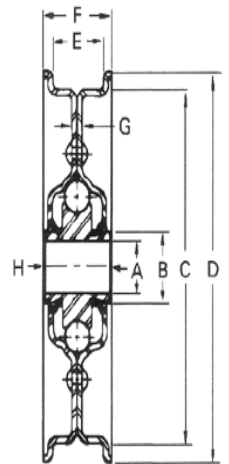

V-Belt Idlers

PART NO.	O.D. (D)	BORE (A)	BELT SIZE (E)	HUB WIDTH (H)	STEEL GAUGE (G)
PTP AG2321A	3 1/4"	1/2"	A	.750	.144
PTP AG2321	3 1/4"	5/8"	A	.750	.144
PTP AG2421A	4 13/32"	1/2"	B	.927	.144
PTP AG2421	4 13/32"	5/8"	B	.927	.144
PTP AG3421A	4 13/32"	1/2"	B	.927	.190
PTP AG2621A	5 3/4"	1/2"	A-B-C	.927	.190
PTP AG2621	5 3/4"	5/8"	A-B-C	.927	.190
PTP AG2721A	7"	1/2"	B-C	.927	.190
PTP AG2721	7"	5/8"	B-C	.927	.190

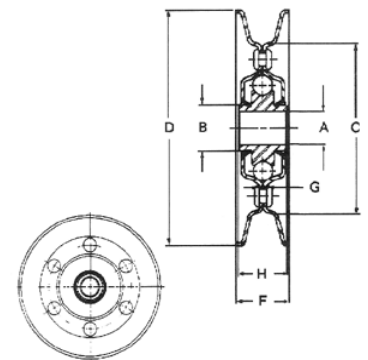

Round Belt Idlers

PART NO.	O.D. (D)	BORE (A)	BELT SIZE (E)	HUB WIDTH (H)	STEEL GAUGE (G)
PTP AG2331A	3 1/4"	1/2"	17/32"	-	.144
PTP AG2331	3 1/4"	5/8"	17/32"	-	.144

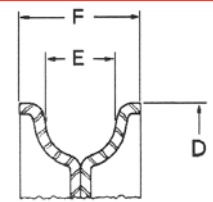

Straight Idlers

PART NO.	O.D. (D)	BORE (A)	BELT SIZE (E)	HUB WIDTH (H)	STEEL GAUGE (G)
PTP AG2367A	2 1/4"	1/2"	A-B-C-D	1.125	.190
PTP AG2367	2 1/4"	5/8"	A-B-C-D	1.125	.190

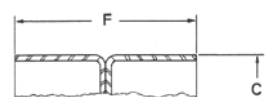

ECONOMICAL ZINC PLATED IDLER PULLEYS

V-Belt

- Noiseless, precision ball bearings.
- Single-row, sealed retainer-type.
- Pulleys for B size V-belts.
- Rugged stamped metal, high-strength brazed or riveted construction.
- Protective zinc plating.

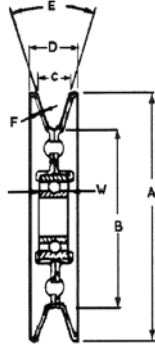

PART NO.	SIZE "A"	BORE	"C"	BELT SIZE
PTP 55950	3"	1/2"	.62	B
PTP 55951	3"	5/8"	.62	B
PTP 55952	3 1/2"	1/2"	.69	B
PTP 55953	3 1/2"	5/8"	.69	B
PTP 55954	4"	1/2"	.63	B
PTP 55955	4"	5/8"	.63	B
PTP 55956	5"	1/2"	.69	A/B
PTP 55957	5"	5/8"	.69	A/B

Flat Belt Double Pulley

- Noiseless, precision ball bearings.
- Single-row, sealed retainer-type.
- Pulleys for A or B sized flat, poly V-belts, back side of V-belts, and cog belts.
- Rugged stamped metal, high-strength riveted construction.
- Protective zinc plating.

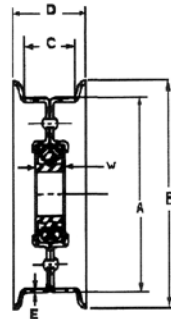

PART NO.	SIZE "A"	BORE	"C"	BELT SIZE
PTP 55959	2 3/4"	1/2"	.87	A/B
PTP 55960	2 3/4"	5/8"	.87	A/B
PTP 55961	4"	1/2"	.86	A/B
PTP 55962	4"	5/8"	.86	A/B
PTP 55963	5"	1/2"	1.31	A/B/C
PTP 55964	5"	5/8"	1.31	A/B/C
PTP 55965	6"	1/2"	2.0	A/B/C
PTP 55966	6"	5/8"	2.0	A/B/C

IDLER PULLEY DISPLAY

Includes:

- 2 - PTP 55950 3" V Idler 1/2" bore
- 2 - PTP 55951 3" V Idler 5/8" bore
- 2 - PTP 55952 3 1/2" V Idler 1/2" bore
- 2 - PTP 55953 3 1/2" V Idler 5/8" bore
- 2 - PTP 55954 4" V Idler 1/2" bore
- 2 - PTP 55955 4" V Idler 5/8" bore
- 2 - PTP 55956 5" V Idler 1/2" bore
- 2 - PTP 55957 5" V Idler 5/8" bore
- 2 - PTP 55959 2 3/4" Flat Idler 1/2" bore
- 2 - PTP 55960 2 3/4" Flat Idler 5/8" bore
- 2 - PTP 55961 4" Flat Idler 1/2" bore
- 2 - PTP 55962 4" Flat Idler 5/8" bore

PART NO.	DESCRIPTION
PRM 559	Display Board



Note: Display board is free when full product package is purchased

BROWNING ROLLER CHAIN DRIVES

Your strongest link to cost savings!

No other manufacturer offers all these exclusive cost-saving features in roller chain drives:

- In-stock hardened sprockets guaranteed to last at least twice as long as the standard mild steel (un-hardened) sprockets they replace. Reduce downtime, increase chain life.
- World's largest selection of shaft-ready sprockets, with three bushing types available: the popular Browning split taper bushing, the QD bushing and the new taper bore bushing. Include millimeter bores as well as standard 1/16" increments. Spline bores available on split taper bushings. Also finished bore types in a full range of stock bores.
- Precision testing methods - Browning regularly used gear checking quality techniques in sprocket manufacturing.

To provide "what-you-want-when-you-want-it" service on made-to-order sprockets, Browning distribution centers carry extensive finished goods inventories, and rework facilities to provide rapid turnaround on modification orders.

Link up with Browning for all your roller chain drive requirements...and you'll be certain of maximum drive efficiency and minimum costs!

Roller Chain drive with bushing type sprockets.

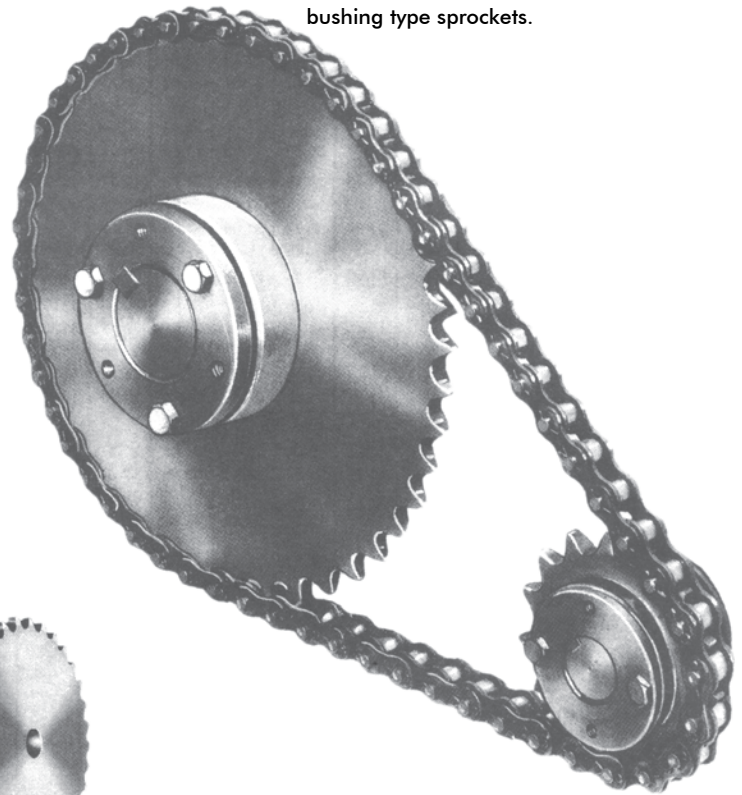

Bushing type single sprocket

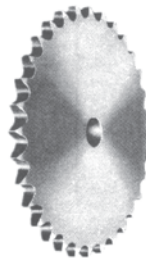

Steel plate sprocket

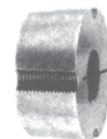
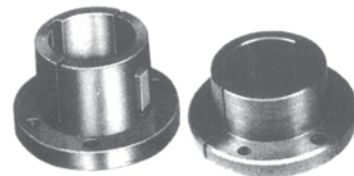

Choice of three bushings



Bushing type double sprockets

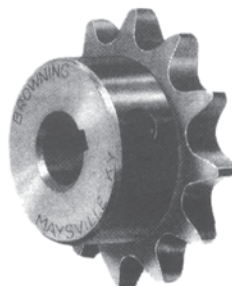

Minimum bore sprocket

See your Westward branch for availability

BROWNING ROLLER CHAIN DRIVES

Single Sprockets

TYPE		25	35	41	40	50	60	80	100	120	140	160	180	200	240
Bushing Type Hardened	Teeth Bore	-	-	-	12 - 40 3/8" - 1 1/4"	11 - 40 3/8" - 2 11/16"	10 - 30 3/8" - 2 11/16"	11 - 30 1/2" - 2 11/16"	11 - 30 1/2" - 2 11/16"	11 - 30 3/4" - 3 3/4"	11 - 26 3/4" - 3 3/4"	11 - 22 1 1/8" - 3 3/4"	-	-	-
Bushing Type Standard	Teeth Bore	-	12 - 120 3/8" - 1 1/2"	12 - 120 3/8" - 1 3/4"	12 - 120 3/8" - 2 11/16"	11 - 120 3/8" - 3 3/4"	10 - 120 3/8" - 4 1/4"	11 - 120 1/2" - 4 1/4"	11 - 120 1/2" - 4 1/4"	11 - 120 3/4" - 5"	27 - 96 1 3/8" - 5"	23 - 84 1 3/8" - 5"	-	11 - 72 1 3/8" - 5"	-
Finished Bore Hardened	Teeth Bore	-	10 - 30 3/8" - 1"	-	9 - 30 1/2" - 1 1/4"	9 - 24 5/8" - 1 1/2"	9 - 20 3/4" - 1 1/2"	9 - 20 1" - 1 1/2"	-	-	-	-	-	-	-
Finished Bore Standard	Teeth Bore	-	9 - 112 3/8" - 1 11/16"	9 - 112 1/2" - 1 1/2"	9 - 112 1/2" - 1 11/16"	9 - 112 5/8" - 1 15/16"	9 - 90 3/4" - 2 7/16"	9 - 65 1" - 2 7/16"	16 - 48 1 1/4" - 2 7/16"	-	-	-	-	-	-
Type B Minimum Bore	Teeth Bore	8 - 120 1/4" - 1 1/4"	8 - 120 3/8" - 2"	6 - 120 3/8" - 2"	8 - 120 1/2" - 2"	8 - 120 1/2" - 2 5/8"	8 - 120 5/8" - 2 3/4"	8 - 120 3/4" - 3"	8 - 120 1" - 4 5/8"	9 - 120 7/16" - 5 1/2"	9 - 96 1 7/16" - 5 3/4"	8 - 90 1 1/2" - 6 3/4"	13 - 60 1 15/16" - 5 1/2"	9 - 72 1 1/2" - 6 3/4"	9 - 60 2 3/16" - 6 3/4"
Type A Steel Plate	Teeth	1896	14 - 120	10 - 120	12 - 120	9 - 120	9 - 120	9 - 120	7 - 120	8 - 120	9 - 96	8 - 90	-	9 - 72	9 - 60
Type B Stainless Steel	Teeth Bore	9 - 80 1/4" - 1 1/4"	9 - 65 3/8" - 2"	-	10 - 120 1/2" - 3"	10 - 120 5/8" - 2 3/8"	12 - 120 3/4" - 3 11/16"	13 - 20 3/4" - 2 3/8"	-	-	-	-	-	-	-

Multiple Sprockets

TYPE		25	35	41	40	50	60	80	100	120	140	160	180	200	240
Bushing Type Double	Teeth Bore	-	14 - 120 3/8" - 2 11/16"	-	15 - 120 3/8" - 2 11/16"	14 - 120 5/8" - 3 3/4"	13 - 120 1/2" - 3 3/4"	13 - 120 1/2" - 5"	11 - 120 1/2" - 5"	30 - 80 1 3/8" - 5"	12 - 80 1 3/8" - 5"	11 - 64 1 3/8" - 5"	-	11 - 30 1 7/8" - 5"	-
Bushing Type Triple	Teeth Bore	-	64 - 120 1/2" - 2 11/16"	-	15 - 120 1/2" - 2 11/16"	15 - 120 3/4" - 4 1/4"	13 - 120 3/4" - 5"	13 - 96 3/4" - 5"	13 - 80 1 3/8" - 5"	12 - 80 1 3/8" - 5"	12 - 45 1 3/8" - 5"	11 - 30 1 3/8" - 5"	-	-	-
Bushing Type Quadruple	Teeth Bore	-	-	-	-	-	-	14 - 20 1" - 2 3/8"	13 - 80 1 3/8" - 5"	12 - 80 1 3/8" - 5"	12 - 32 1 3/8" - 5"	11 - 30 1 3/8" - 5"	-	-	-
Type B Min. Bore. Double	Teeth Bore	-	12 - 120 1/2" - 2 1/4"	-	11 - 120 1/2" - 2 3/4"	11 - 120 5/8" - 3 3/8"	11 - 120 1" - 3 5/8"	10 - 120 3/4" - 4 3/8"	9 - 120 1" - 5"	11 - 120 1 1/2" - 6 7/16"	11 - 96 1 5/8" - 6 7/16"	11 - 84 2" - 6 3/4"	-	11 - 72 2" - 7 5/8"	12 - 60 2 3/16" - 8 1/4"
Type B Min. Bore Triple	Teeth Bore	-	13 - 120 1/2" - 2 3/8"	-	11 - 60 1/2" - 2 3/8"	11 - 120 5/8" - 3 3/8"	11 - 120 1" - 3 5/8"	10 - 120 3/4" - 4 3/8"	11 - 120 1" - 5 1/2"	11 - 120 1 1/2" - 6 1/8"	11 - 96 1 5/8" - 7 3/8"	11 - 84 2" - 7 5/8"	-	11 - 72 2 1/16" - 8 1/8"	-
Type B Min. Bore Quadruple	Teeth Bore	-	13 - 120 1/2" - 2 5/8"	-	13 - 120 1/2" - 2 3/4"	13 - 120 5/8" - 3 3/8"	14 - 120 1" - 3 3/8"	13 - 120 1" - 4 7/16"	11 - 120 1" - 5 3/4"	12 - 120 1 1/2" - 7 3/8"	12 - 96 1 3/8" - 7 3/8"	12 - 84 2" - 8"	-	12 - 72 2 1/16" - 9 1/4"	-

Other Sprockets

	PITCH	TEETH	BORE RANGE
Double Single Sprockets	40 - 100	13 - 25	3/8" - 3 3/4"
Bushing Type	40 - 100	13 - 25	-
Type A Steel Plate	2040 - 2080	17 - 23	3/8" - 2 11/16"
Extended Pitch Sprockets	2040 - 2082	8 - 40	5/8" - 3"
	2102	9 - 21	1 1/4" - 3"



Roller Chain (ansi)

SINGLE STRAND	PITCH
Standard	25 - 200
Heavy	60 - 160
Stainless Steel	25 - 80
Pre-lubricated	40 - 80
Offset side bar	3100 - 3160
Multi-flex	100 - 200
Extended pitch drive chain	2040 - 2060
Extended pitch conveyor chain	
Standard roller	2040 - 2120
Large roller	2042 - 2082
Chain attachments	
Standard	25 - 160
Extended pitch	2040 - 2080, 2042 - 2082
MULTIPLE STRAND	PITCH
Standard - double, triple, quadruple	35 - 200
Heavy - double, triple, quadruple	60 - 160
Pre-lubricated - double	40 - 80

SPROCKETS

Westward Parts stocks a complete line of Browning bushing style and minimum bore "B" type sprockets. The Browning split taper bushed style sprockets incorporate the Browning bushing system, which accommodates the complete round shaft coverage plus millimeter and spline bores as shown:

All Browning bushing type sprockets shown having 30 teeth or less, are supplied with hardened teeth and are guaranteed to last twice as long as any standard sprocket.

TYPE	INCH	MILLIMETER
G Bushing	$\frac{3}{8} - 1$	10 - 25
H Bushing	$\frac{3}{8} - 1 \frac{1}{2}$	10 - 38
P1 Bushing	$\frac{1}{2} - 1 \frac{3}{4}$	14 - 42
Q1 Bushing	$\frac{3}{4} - 2 \frac{11}{16}$	18 - 65
R1 Bushing	$1 \frac{1}{8} - 3 \frac{3}{4}$	28 - 95
S1 Bushing	$1 \frac{11}{16} - 4 \frac{1}{4}$	-

Other advantages of Browning sprockets:

- off the shelf delivery
- no machining required on bushing type sprockets
- excellent coverage of all bore sizes and types
- easy installation and removal
- minimum down times

Spline Bores

	H	P1	Q1
.978 - 10INV	X	X	-
$1 \frac{1}{8} - 6B$	X	X	X
$1 \frac{1}{4} - 10B$	-	X	-
$1 \frac{3}{8} - 6B$	X	X	X
$1 \frac{3}{8} - 10B$	-	X	X
$1 \frac{3}{8} - 21INV$	X	X	X

Westward Parts also has available a full line of both QD & Taper Lok style sprockets. See your nearest branch for availability.

"B" TYPE SPROCKETS

For #35 Roller Chain

Steel Type "B" Minimum Bore Single Sprockets

PART NO.	DIAMETERS		NO. TEETH	TYPE	BORE		DIMENSIONS				WT. LBS.
	OUT-SIDE	PITCH			STOCK	MAX. *	T NOM.	L MAX.	P	H	
35B8	1.12"	.980"	8	B	3/8"	3/8"	.168"	3/4"	37/64"	3/4" +	.1
35B9	1.25"	1.096	9	B	3/8"	3/8"	.168"	3/4"	37/64"	27/32" +	.1
35B10	1.37"	1.214	10	B	3/8"	9/16"	.168"	3/4"	37/64"	1 5/16" +	.1
35B11	1.50"	1.331	11	B	3/8"	9/16"	.168"	3/4"	37/64"	1 7/16" +	.1
35B12	1.62"	1.449	12	B	1/2"	3/4"	.168"	3/4"	37/64"	1 7/16" +	.1
35B13	1.75"	1.567	13	B	1/2"	3/4"	.168"	3/4"	37/64"	1 7/16" +	.3
35B14	1.87"	1.685	14	B	1/2"	7/8"	.168"	3/4"	37/64"	1 7/16" +	.3
35B15	1.99"	1.804	15	B	1/2"	7/8"	.168"	3/4"	37/64"	1 9/16" +	.3
35B16	2.10"	1.922	16	B	1/2"	15/16"	.168"	3/4"	37/64"	1 11/16" +	.4
35B17	2.23"	2.041	17	B	1/2"	1 1/16"	.168"	3/4"	37/64"	1 11/16" +	.4
35B18	2.35"	2.159	18	B	1/2"	1 3/16"	.168"	3/4"	37/64"	1 3/4"	.5
35B19	2.47"	2.278	19	B	1/2"	1 1/4"	.168"	3/4"	37/64"	1 27/32"	.6
35B20	2.59"	2.397	20	B	1/2"	1 5/16"	.168"	3/4"	37/64"	1 15/16"	.7
35B21	2.70"	2.516	21	B	1/2"	1 1/4"	.168"	27/32"	43/64"	2 1/16"	.8
35B22	2.83"	2.635	22	B	1/2"	1 3/8"	.168"	27/32"	43/64"	2 3/16"	.9
35B23	2.95"	2.754	23	B	1/2"	1 3/8"	.168"	27/32"	43/64"	2 3/16"	1.0
35B24	3.05"	2.873	24	B	1/2"	1 9/16"	.168"	27/32"	43/64"	2 7/16"	1.2
35B25	3.19"	2.992	25	B	1/2"	1 5/8"	.168"	27/32"	43/64"	2 1/2"	1.3
35B26	3.31"	3.111	26	B	1/2"	1 5/8"	.168"	27/32"	43/64"	2 1/2"	1.3
35B27	3.43"	3.230	27	B	1/2"	1 5/8"	.168"	27/32"	43/64"	2 1/2"	1.3
35B28	3.55"	3.349	28	B	1/2"	1 5/8"	.168"	27/32"	43/64"	2 1/2"	1.3
35B30	3.79"	3.588	30	B	1/2"	1 5/8"	.168"	27/32"	43/64"	2 1/2"	1.4
35B32	4.03"	3.826	32	B	1/2"	1 5/8"	.168"	27/32"	43/64"	2 1/2"	1.5
35B35	4.39"	4.183	35	B	1/2"	1 5/8"	.168"	27/32"	43/64"	2 1/2"	1.5
35B36	4.51"	4.303	36	B	5/8"	1 5/8"	.168"	27/32"	43/64"	2 1/2"	1.5
35B40	4.99"	4.780	40	B	5/8"	1 5/8"	.168"	27/32"	43/64"	2 1/2"	1.9
35B42	5.23"	5.018	42	B	5/8"	2"	.168"	27/32"	43/64"	3"	2.3
35B45	5.59"	5.376	45	B	5/8"	2"	.168"	27/32"	43/64"	3"	2.5
35B48	5.95"	5.734	48	B	5/8"	2"	.168"	27/32"	43/64"	3"	2.9
35B54	6.66"	6.449	54	B	5/8"	2"	.168"	27/32"	43/64"	3"	3.3
35B60	7.38"	7.165	60	B	5/8"	2"	.168"	27/32"	43/64"	3"	3.7
35B70	8.58"	8.358	70	B	5/8"	2"	.168"	27/32"	43/64"	3"	4.7
35B72	8.81"	8.597	72	B	5/8"	2"	.168"	27/32"	43/64"	3"	4.9
35B80	9.77"	9.552	80	B	5/8"	2"	.168"	27/32"	43/64"	3"	5.8
35B84	10.25"	10.029	84	B	5/8"	2"	.168"	27/32"	43/64"	3"	6.2
35B96	11.68"	11.461	96	B	5/8"	2"	.168"	27/32"	43/64"	3"	7.7
35B112	13.59"	13.371	112	B	5/8"	2"	.168"	27/32"	43/64"	3"	10.1

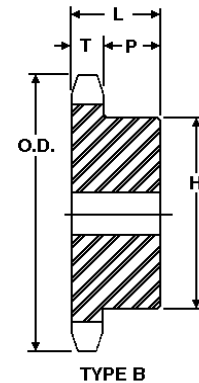
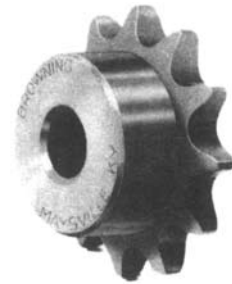

*Maximum bore shown is with standard keyway and setscrew over keyway. Slightly larger bores are possible with no keyway, shallow keyway or setscrew at angle to keyway.

+ Hub is recessed for chain clearance.

Type "B" sprockets are made without keyways and setscrew. They are furnished with minimum bore which can be rebored to size, keywayed and setscrewed for a reasonable extra charge.

"B" TYPE SPROCKETS

Steel Type "B" Minimum Bore Single Sprockets

PART NO.	DIAMETERS		NO. TEETH	TYPE	BORE		DIMENSIONS				WT. LBS.
	OUT-SIDE	PITCH			STOCK	MAX. *	T NOM.	L MAX.	P	H	
40B8	1.50"	1.307"	8	B	1/2"	1/2"	.284"	7/8"	19/32"	31/32" +	.1
40B9	1.67"	1.462	9	B	1/2"	9/16"	.284"	7/8"	19/32"	1 1/8" +	.2
40B10	1.84"	1.618	10	B	1/2"	3/4"	.284"	7/8"	19/32"	1 9/32" +	.3
40B11	2.00"	1.775	11	B	1/2"	7/8"	.284"	7/8"	19/32"	1 7/16" +	.3
40B12	2.17"	1.932	12	B	1/2"	1"	.284"	7/8"	19/32"	1 19/32" +	.4
40B13	2.30"	2.089	13	B	1/2"	1 1/16"	.284"	7/8"	19/32"	1 3/4" +	.5
40B14	2.49"	2.247	14	B	1/2"	1 1/8"	.284"	7/8"	19/32"	1 7/8" +	.6
40B15	2.65"	2.405	15	B	1/2"	1 1/4"	.284"	7/8"	19/32"	2" +	.7
40B16	2.80"	2.563	16	B	5/8"	1 3/8"	.284"	7/8"	19/32"	2 1/16"	.8
40B17	2.96"	2.721	17	B	5/8"	1 7/16"	.284"	7/8"	19/32"	2 3/16"	.9
40B18	3.14"	2.879	18	B	5/8"	1 1/2"	.284"	7/8"	19/32"	2 3/8"	1.1
40B19	3.30"	3.038	19	B	5/8"	1 3/4"	.284"	7/8"	19/32"	2 1/2"	1.4
40B20	3.45"	3.196	20	B	5/8"	1 7/8"	.284"	15/16"	21/32"	2 5/8"	1.6
40B21	3.62"	3.355	21	B	5/8"	1 7/8"	.284"	15/16"	21/32"	2 3/4"	1.7
40B22	3.75"	3.513	22	B	5/8"	1 7/8"	.284"	15/16"	21/32"	2 7/8"	1.9
40B23	3.94"	3.672	23	B	5/8"	2"	.284"	15/16"	21/32"	3	2.1
40B24	4.10"	3.831	24	B	5/8"	2 1/4"	.284"	15/16"	21/32"	3 1/4"	2.4
40B25	4.26"	3.989	25	B	5/8"	2 1/4"	.284"	15/16"	21/32"	3 1/4"	2.5
40B26	4.42"	4.148	26	B	5/8"	2 1/4"	.284"	15/16"	21/32"	3 1/4"	2.5
40B27	4.58"	4.307	27	B	5/8"	2 1/4"	.284"	15/16"	21/32"	3 1/4"	2.6
40B28	4.74"	4.466	28	B	5/8"	2 1/4"	.284"	15/16"	21/32"	3 1/4"	2.7
40B30	5.06"	4.783	30	B	5/8"	2 1/4"	.284"	15/16"	21/32"	3 1/4"	2.9
40B32	5.38"	5.101	32	B	5/8"	2 1/4"	.284"	15/16"	21/32"	3 1/4"	3.1
40B33	5.54"	5.260	33	B	5/8"	2 1/4"	.284"	15/16"	21/32"	3 1/4"	3.2
40B34	5.70"	5.419	34	B	5/8"	2 1/4"	.284"	15/16"	21/32"	3 1/4"	3.3
40B35	5.86"	5.578	35	B	5/8"	2 1/4"	.284"	15/16"	21/32"	3 1/4"	3.4
40B36	6.02"	5.737	36	B	5/8"	2 1/4"	.284"	15/16"	21/32"	3 1/4"	3.5
40B38	6.33"	6.055	38	B	5/8"	2 1/4"	.284"	15/16"	21/32"	3 1/4"	3.8
40B40	6.65"	6.373	40	B	5/8"	2 3/8"	.284"	15/16"	21/32"	3 1/2"	4.3
40B41	6.81"	6.532	41	B	5/8"	2 3/8"	.284"	15/16"	21/32"	3 1/2"	4.4
40B42	6.97"	6.691	42	B	5/8"	2 3/8"	.284"	15/16"	21/32"	3 1/2"	4.5
40B45	7.45"	7.168	45	B	5/8"	2 3/8"	.284"	15/16"	21/32"	3 1/2"	4.9
40B47	7.77"	7.486	47	B	5/8"	2 3/8"	.284"	15/16"	21/32"	3 1/2"	5.2
40B48	7.93"	7.645	48	B	5/8"	2 3/8"	.284"	15/16"	21/32"	3 1/2"	5.4
40B50	8.25"	7.963	50	B	5/8"	2 3/8"	.284"	15/16"	21/32"	3 1/2"	5.7
40B54	8.89"	8.599	54	B	5/8"	2 3/8"	.284"	15/16"	21/32"	3 1/2"	6.4
40B60	9.84"	9.554	60	B	5/8"	2 3/8"	.284"	15/16"	21/32"	3 1/2"	7.5
40B70	11.43"	11.145	70	B	5/8"	2 3/4"	.284"	15/16"	21/32"	4"	10.1
40B72	11.75"	11.463	72	B	5/8"	2 3/4"	.284"	15/16"	21/32"	4"	10.5
40B80	13.03"	12.736	80	B	5/8"	2 3/4"	.284"	15/16"	21/32"	4"	12.5
40B84	13.66"	13.372	84	B	3/4"	2 3/4"	.284"	1"	23/32"	4"	13.7
40B96	15.57"	15.281	96	B	3/4"	2 3/4"	.284"	1"	23/32"	4"	17.2
40B112	18.12"	17.828	112	B	3/4"	2 3/4"	.284"	1"	23/32"	4"	22.5

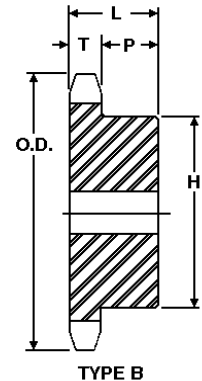
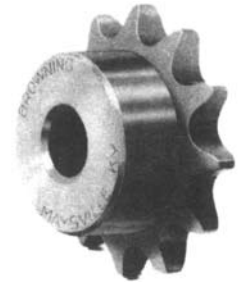

Standard Keysets
Table No. 3

BORE RANGE	KEYSEAT
3/8" - 7/16"	None
1/2" - 9/16"	1/8" x 1/16"
5/8" - 7/8"	3/16" x 3/32"
15/16" - 1 1/4"	1/4" x 1/8"
1 5/16" - 1 3/8"	5/16" x 5/32"
1 7/16" - 1 3/4"	3/8" - 3/16"

*1 3/8" bore bushings also available with 3/8" x 3/16" keyseat.

*Maximum bore shown is with standard keyway and setscrew over keyway. Slightly larger bores are possible with no keyway, shallow keyway or setscrew at angle to keyway.

+ Hub is recessed for chain clearance.

Type "B" sprockets are made without keyways and setscrew. They are furnished with minimum bore which can be rebored to size, keywayed and setscrewed for a reasonable extra charge.

"B" TYPE SPROCKETS

For #50 Roller Chain

Sprockets for No. 50, $\frac{5}{8}$ " Pitch ANSI Chain
Steel Type "B" Minimum Bore Single Sprockets

PART NO.	DIAMETERS		NO. TEETH	TYPE	BORE		DIMENSIONS				WT. LBS.
	OUT-SIDE	PITCH			STOCK	MAX. *	T NOM.	L MAX.	P	H	
50B8	1.88"	1.633"	8	B	$\frac{1}{2}$ "	$\frac{5}{8}$ "	.343"	1	$\frac{21}{32}$ "	$1\frac{3}{16}$ " +	.3
50B9	2.09"	1.827	9	B	$\frac{5}{8}$ "	$\frac{3}{4}$ "	.343	1	$\frac{21}{32}$ "	$1\frac{3}{8}$ " +	.4
50B10	2.30"	2.023	10	B	$\frac{5}{8}$ "	$\frac{7}{8}$ "	.343	1	$\frac{21}{32}$ "	$1\frac{9}{16}$ " +	.5
50B11	2.50"	2.219	11	B	$\frac{5}{8}$ "	1"	.343	1	$\frac{21}{32}$ "	$1\frac{3}{4}$ " +	.6
50B12	2.70"	2.415	12	B	$\frac{5}{8}$ "	$1\frac{1}{4}$ "	.343	1	$\frac{21}{32}$ "	$1\frac{63}{64}$ " +	.8
50B13	2.91"	2.612	13	B	$\frac{5}{8}$ "	$1\frac{5}{16}$ "	.343	1	$\frac{21}{32}$ "	2 +	.8
50B14	3.11"	2.809	14	B	$\frac{5}{8}$ "	$1\frac{7}{16}$ "	.343	1	$\frac{21}{32}$ "	$2\frac{1}{8}$ "	1.0
50B15	3.32"	3.006	15	B	$\frac{5}{8}$ "	$1\frac{1}{2}$ "	.343	1	$\frac{21}{32}$ "	$2\frac{3}{8}$ "	1.3
50B16	3.52"	3.204	16	B	$\frac{5}{8}$ "	$1\frac{3}{4}$ "	.343	1	$\frac{21}{32}$ "	$2\frac{9}{16}$ "	1.6
50B17	3.72"	3.401	17	B	$\frac{5}{8}$ "	$1\frac{7}{8}$ "	.343	1	$\frac{21}{32}$ "	$2\frac{11}{16}$ "	1.8
50B18	3.92"	3.599	18	B	$\frac{5}{8}$ "	$1\frac{7}{8}$ "	.343	1	$\frac{21}{32}$ "	$2\frac{7}{8}$ "	2.0
50B19	4.12"	3.797	19	B	$\frac{5}{8}$ "	2"	.343	1	$\frac{21}{32}$ "	3	2.3
50B20	4.32"	3.995	20	B	$\frac{3}{4}$ "	2"	.343	1	$\frac{21}{32}$ "	3	2.6
50B21	4.52"	4.194	21	B	$\frac{3}{4}$ "	$2\frac{1}{4}$ "	.343	1	$\frac{21}{32}$ "	$3\frac{3}{8}$ "	2.9
50B22	4.72"	4.392	22	B	$\frac{3}{4}$ "	$2\frac{1}{4}$ "	.343	1	$\frac{21}{32}$ "	$3\frac{1}{4}$ "	3.0
50B23	4.92"	4.590	23	B	$\frac{3}{4}$ "	$2\frac{1}{4}$ "	.343	1	$\frac{21}{32}$ "	$3\frac{1}{4}$ "	3.3
50B24	5.12"	4.788	24	B	$\frac{3}{4}$ "	$2\frac{1}{4}$ "	.343	$1\frac{1}{16}$ "	$\frac{23}{32}$ "	$3\frac{1}{4}$ "	3.5
50B25	5.32"	4.987	25	B	$\frac{3}{4}$ "	$2\frac{1}{4}$ "	.343	$1\frac{1}{16}$ "	$\frac{23}{32}$ "	$3\frac{1}{4}$ "	3.6
50B26	5.52"	5.185	26	B	$\frac{3}{4}$ "	$2\frac{1}{4}$ "	.343	$1\frac{1}{16}$ "	$\frac{23}{32}$ "	$3\frac{1}{4}$ "	3.7
50B27	5.72"	5.384	27	B	$\frac{3}{4}$ "	$2\frac{1}{4}$ "	.343	$1\frac{1}{16}$ "	$\frac{23}{32}$ "	$3\frac{1}{4}$ "	3.8
50B28	5.92"	5.582	28	B	$\frac{3}{4}$ "	$2\frac{1}{4}$ "	.343	$1\frac{1}{16}$ "	$\frac{23}{32}$ "	$3\frac{1}{4}$ "	4.0
50B29	6.12"	5.781	29	B	$\frac{3}{4}$ "	$2\frac{1}{4}$ "	.343	$1\frac{1}{16}$ "	$\frac{23}{32}$ "	$3\frac{1}{4}$ "	4.2
50B30	6.32"	5.979	30	B	$\frac{3}{4}$ "	$2\frac{1}{4}$ "	.343	$1\frac{1}{16}$ "	$\frac{23}{32}$ "	$3\frac{1}{4}$ "	4.4
50B31	6.52"	6.178	31	B	$\frac{3}{4}$ "	$2\frac{1}{4}$ "	.343	$1\frac{1}{16}$ "	$\frac{23}{32}$ "	$3\frac{1}{4}$ "	4.6
50B32	6.72"	6.376	32	B	$\frac{3}{4}$ "	$2\frac{1}{4}$ "	.343	$1\frac{1}{16}$ "	$\frac{23}{32}$ "	$3\frac{1}{4}$ "	4.7
50B33	6.92"	6.575	33	B	$\frac{3}{4}$ "	$2\frac{1}{4}$ "	.343	$1\frac{1}{16}$ "	$\frac{23}{32}$ "	$3\frac{1}{4}$ "	4.9
50B34	7.12"	6.774	34	B	$\frac{3}{4}$ "	$2\frac{1}{4}$ "	.343	$1\frac{1}{16}$ "	$\frac{23}{32}$ "	$3\frac{1}{4}$ "	5.1
50B35	7.32"	6.972	35	B	$\frac{3}{4}$ "	$2\frac{3}{8}$ "	.343	$1\frac{1}{16}$ "	$\frac{23}{32}$ "	$3\frac{1}{2}$ "	5.5
50B36	7.52"	7.171	36	B	$\frac{3}{4}$ "	$2\frac{3}{8}$ "	.343	$1\frac{1}{16}$ "	$\frac{23}{32}$ "	$3\frac{1}{2}$ "	5.7
50B38	7.92"	7.569	38	B	$\frac{3}{4}$ "	$2\frac{3}{8}$ "	.343	$1\frac{1}{16}$ "	$\frac{23}{32}$ "	$3\frac{1}{2}$ "	6.0
50B39	8.12"	7.767	39	B	$\frac{3}{4}$ "	$2\frac{3}{8}$ "	.343	$1\frac{1}{16}$ "	$\frac{23}{32}$ "	$3\frac{1}{2}$ "	6.4
50B40	8.32"	7.966	40	B	$\frac{3}{4}$ "	$2\frac{3}{8}$ "	.343	$1\frac{1}{16}$ "	$\frac{23}{32}$ "	$3\frac{1}{2}$ "	6.7
50B42	8.72"	8.363	42	B	$\frac{3}{4}$ "	$2\frac{3}{8}$ "	.343	$1\frac{1}{16}$ "	$\frac{23}{32}$ "	$3\frac{1}{2}$ "	7.2
50B44	9.11"	8.761	44	B	$\frac{3}{4}$ "	$2\frac{3}{8}$ "	.343	$1\frac{1}{16}$ "	$\frac{23}{32}$ "	$3\frac{1}{2}$ "	7.7
50B45	9.31"	8.960	45	B	$\frac{3}{4}$ "	$2\frac{1}{2}$ "	.343	$1\frac{1}{16}$ "	$\frac{23}{32}$ "	$3\frac{3}{4}$ "	8.2
50B48	9.91"	9.556	48	B	$\frac{3}{4}$ "	$2\frac{1}{2}$ "	.343	$1\frac{1}{16}$ "	$\frac{23}{32}$ "	$3\frac{3}{4}$ "	9.1
50B50	10.31"	9.954	50	B	$\frac{3}{4}$ "	$2\frac{1}{2}$ "	.343	$1\frac{1}{16}$ "	$\frac{23}{32}$ "	$3\frac{3}{4}$ "	9.7
50B52	10.71"	10.351	52	B	$\frac{3}{4}$ "	$2\frac{1}{2}$ "	.343	$1\frac{1}{16}$ "	$\frac{23}{32}$ "	$3\frac{3}{4}$ "	10.3
50B54	11.11"	10.749	54	B	$\frac{3}{4}$ "	$2\frac{1}{2}$ "	.343	$1\frac{1}{16}$ "	$\frac{23}{32}$ "	$3\frac{3}{4}$ "	10.9
50B60	12.30"	11.942	60	B	$\frac{3}{4}$ "	$2\frac{1}{2}$ "	.343	$1\frac{1}{16}$ "	$\frac{23}{32}$ "	$3\frac{3}{4}$ "	13.0
50B70	14.29"	13.931	70	B	$\frac{3}{4}$ "	$2\frac{1}{2}$ "	.343	$1\frac{1}{4}$ "	$\frac{29}{32}$ "	$3\frac{3}{4}$ "	17.5
50B72	14.69"	14.329	72	B	$\frac{3}{4}$ "	$2\frac{1}{2}$ "	.343	$1\frac{1}{4}$ "	$\frac{29}{32}$ "	$3\frac{3}{4}$ "	18.3
50B76	15.49"	15.124	76	B	$\frac{3}{4}$ "	$2\frac{1}{2}$ "	.343	$1\frac{1}{4}$ "	$\frac{29}{32}$ "	$3\frac{3}{4}$ "	20.1
50B80	16.28"	15.920	80	B	$\frac{3}{4}$ "	$3\frac{1}{8}$ "	.343	$1\frac{5}{8}$ "	$1\frac{9}{32}$ "	$4\frac{5}{8}$ "	25.2
50B84	17.08"	16.715	84	B	$\frac{3}{4}$ "	$3\frac{1}{8}$ "	.343	$1\frac{5}{8}$ "	$1\frac{9}{32}$ "	$4\frac{5}{8}$ "	27.2
50B90	18.27"	17.909	90	B	$\frac{3}{4}$ "	$3\frac{1}{8}$ "	.343	$1\frac{5}{8}$ "	$1\frac{9}{32}$ "	$4\frac{5}{8}$ "	30.3
50B95	19.27"	18.903	95	B	$\frac{3}{4}$ "	$3\frac{1}{8}$ "	.343	$1\frac{5}{8}$ "	$1\frac{9}{32}$ "	$4\frac{5}{8}$ "	33.1
50B96	19.47"	19.102	96	B	$\frac{3}{4}$ "	$3\frac{1}{8}$ "	.343	$1\frac{5}{8}$ "	$1\frac{9}{32}$ "	$4\frac{5}{8}$ "	33.7
50B112	22.65"	22.285	112	B	$\frac{3}{4}$ "	$3\frac{1}{8}$ "	.343	$1\frac{5}{8}$ "	$1\frac{9}{32}$ "	$4\frac{5}{8}$ "	43.8

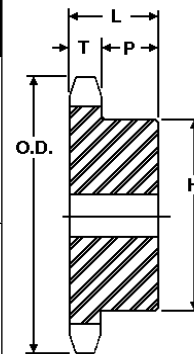

TYPE B

*Maximum bore shown is with standard keyway and setscrew over keyway. Slightly larger bores are possible with no keyway, shallow keyway or setscrew at angle to keyway.

+ Hub is recessed for chain clearance.

Type "B" sprockets are made without keyways and setscrew. They are furnished with minimum bore which can be rebored to size, keywayed and setscrewed for a reasonable extra charge.

"B" TYPE SPROCKETS

For #60 Roller Chain

Sprockets for No. 60, 3/4" Pitch ANSI Chain
Steel Single Type "B" Minimum Bore Sprockets

PART NO.	DIAMETERS		NO. TEETH	TYPE	BORE		DIMENSIONS				WT. LBS.
	OUTSIDE	PITCH			STOCK	MAX. *	T NOM.	L MAX.	P	H	
60B8	2.26"	1.960"	8	B	5/8"	13/16"	.459"	1 3/16"	47/64"	1 15/32" +	.5
60B9	2.50"	2.193"	9	B	3/4"	15/16"	.459"	1 3/16"	47/64"	1 11/16" +	.6
60B10	2.76"	2.427"	10	B	3/4"	1 3/16"	.459"	1 3/16"	47/64"	1 29/32" +	.9
60B11	2.96"	2.662"	11	B	3/4"	1 5/16"	.459"	1 3/16"	47/64"	2 1/16" +	1.0
60B12	3.25"	2.898"	12	B	3/4"	1 3/8"	.459"	1 3/16"	47/64"	2 3/8" +	1.3
60B13	3.45"	3.134"	13	B	3/4"	1 1/2"	.459"	1 3/16"	47/64"	2 3/8"	1.7
60B14	3.74"	3.371"	14	B	3/4"	1 3/4"	.459"	1 3/16"	47/64"	2 9/16"	2.0
60B15	3.98"	3.607"	15	B	3/4"	1 7/8"	.459"	1 3/16"	47/64"	2 7/8"	2.4
60B16	4.22"	3.844"	16	B	3/4"	2"	.459"	1 3/16"	47/64"	3 1/16"	2.8
60B17	4.46"	4.082"	17	B	3/4"	2 1/4"	.459"	1 3/16"	47/64"	3 3/8"	3.2
60B18	4.70"	4.319"	18	B	3/4"	2 3/8"	.459"	1 3/16"	47/64"	3 1/2"	3.9
60B19	4.95"	4.557"	19	B	3/4"	2 3/8"	.459"	1 3/16"	47/64"	3 1/2"	4.2
60B20	5.19"	4.794"	20	B	3/4"	2 5/8"	.459"	1 3/16"	47/64"	3 7/8"	4.6
60B21	5.43"	5.032"	21	B	3/4"	2 5/8"	.459"	1 3/16"	47/64"	3 7/8"	4.8
60B22	5.67"	5.270"	22	B	3/4"	2 5/8"	.459"	1 3/16"	47/64"	3 7/8"	5.1
60B23	5.91"	5.508"	23	B	3/4"	2 5/8"	.459"	1 3/16"	47/64"	3 7/8"	5.3
60B24	6.15"	5.746"	24	B	3/4"	2 5/8"	.459"	1 3/16"	47/64"	4"	5.6
60B25	6.39"	5.984"	25	B	3/4"	2 3/4"	.459"	1 3/16"	47/64"	4"	6.1
60B26	6.63"	6.222"	26	B	3/4"	2 3/4"	.459"	1 3/16"	47/64"	4"	6.4
60B27	6.87"	6.460"	27	B	3/4"	2 3/4"	.459"	1 3/16"	47/64"	4"	6.7
60B28	7.11"	6.699"	28	B	3/4"	2 3/4"	.459"	1 3/16"	47/64"	4"	7.0
60B29	7.35"	6.937"	29	B	3/4"	2 3/4"	.459"	1 3/16"	47/64"	4"	7.4
60B30	7.59"	7.175"	30	B	3/4"	2 3/4"	.459"	1 3/16"	47/64"	4"	7.7
60B31	7.83"	7.413"	31	B	3/4"	2 3/4"	.459"	1 3/16"	47/64"	4"	8.0
60B32	8.07"	7.652"	32	B	3/4"	2 3/4"	.459"	1 3/16"	47/64"	4"	8.4
60B33	8.30"	7.890"	33	B	3/4"	2 3/4"	.459"	1 3/16"	47/64"	4"	8.8
60B34	8.54"	8.129"	34	B	3/4"	2 3/4"	.459"	1 3/16"	47/64"	4"	9.2
60B35	8.78"	8.367"	35	B	3/4"	2 3/4"	.459"	1 3/16"	47/64"	4"	9.6
60B36	9.02"	8.605"	36	B	3/4"	2 3/4"	.459"	1 3/16"	47/64"	4"	10.0
60B37	9.26"	8.844"	37	B	3/4"	2 3/4"	.459"	1 3/16"	47/64"	4"	10.4
60B38	9.50"	9.082"	38	B	3/4"	2 3/4"	.459"	1 3/16"	47/64"	4 1/4"	11.2
60B39	9.74"	9.321"	39	B	3/4"	2 3/4"	.459"	1 3/16"	47/64"	4 1/4"	11.6
60B40	9.98"	9.559"	40	B	3/4"	2 3/4"	.459"	1 3/16"	47/64"	4 1/4"	12.1
60B41	10.22"	9.798"	41	B	3/4"	2 3/4"	.459"	1 3/16"	47/64"	4 1/4"	12.6
60B42	10.46"	10.036"	42	B	3/4"	2 3/4"	.459"	1 3/16"	47/64"	4 1/4"	13.1
60B44	10.94"	10.513"	44	B	3/4"	2 3/4"	.459"	1 3/16"	47/64"	4 1/4"	14.1
60B45	11.18"	10.752"	45	B	3/4"	2 3/4"	.459"	1 3/16"	47/64"	4 1/4"	14.6
60B47	11.65"	11.229"	47	B	3/4"	2 3/4"	.459"	1 3/16"	47/64"	4 1/4"	15.6
60B48	11.89"	11.467"	48	B	3/4"	2 3/4"	.459"	1 3/16"	47/64"	4 1/4"	16.2
60B50	12.37"	11.945"	50	B	3/4"	2 3/4"	.459"	1 3/16"	47/64"	4 1/4"	17.3
60B54	13.33"	12.899"	54	B	3/4"	2 3/4"	.459"	1 3/16"	47/64"	4 1/4"	19.8
60B56	13.81"	13.376"	56	B	3/4"	3 1/8"	.459"	1 3/4"	1 19/64"	4 5/8"	24.2
60B60	14.76"	14.331"	60	B	3/4"	3 1/8"	.459"	1 3/4"	1 19/64"	4 5/8"	26.9
60B64	15.72"	15.285"	64	B	3/4"	3 1/8"	.459"	1 3/4"	1 19/64"	4 5/8"	29.8
60B65	15.96"	15.524"	65	B	3/4"	3 1/8"	.459"	1 3/4"	1 19/64"	4 5/8"	30.5
60B68	16.67"	16.240"	68	B	3/4"	3 1/8"	.459"	1 3/4"	1 19/64"	4 5/8"	32.8
60B70	17.15"	16.717"	70	B	3/4"	3 1/8"	.459"	1 3/4"	1 19/64"	4 5/8"	34.4
60B72	17.63"	17.194"	72	B	3/4"	3 1/8"	.459"	1 3/4"	1 19/64"	4 5/8"	36.1
60B76	18.58"	18.149"	76	B	1"	3 1/4"	.459"	1 13/16"	1 23/64"	4 3/4"	40.0
60B80	19.54"	19.103"	80	B	1"	3 1/4"	.459"	1 13/16"	1 23/64"	4 3/4"	43.6
60B84	20.49"	20.058"	84	B	1"	3 1/4"	.459"	1 13/16"	1 23/64"	4 3/4"	47.4
60B90	21.93"	21.490"	90	B	1"	4"	.459"	2 1/8"	1 43/64"	6"	60.0
60B96	23.36"	22.922"	96	B	1"	4"	.459"	2 1/8"	1 43/64"	6"	66.5
60B112	27.18"	26.742"	112	B	1"	4"	.459"	2 1/8"	1 43/64"	6"	85.8

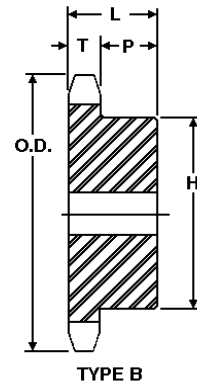

*Maximum bore shown is with standard keyway and setscrew over keyway. Slightly larger bores are possible with no keyway, shallow keyway or setscrew at angle to keyway.

+ Hub is recessed for chain clearance.

Type "B" sprockets are made without keyways and setscrew. They are furnished with minimum bore which can be rebored to size, keywayed and setscrewed for a reasonable extra charge.

"B" TYPE SPROCKETS

For #80 Roller Chain

Sprockets for No. 80, 1" Pitch ANSI Chain
Steel Single Type "B" Minimum Bore Sprockets

PART NO.	DIAMETERS		NO. TEETH	TYPE	BORE		DIMENSIONS				WT. LBS.
	OUTSIDE	PITCH			STOCK	MAX. *	T NOM.	L MAX.	P	H	
80B8	3.01"	2.613"	8	B	3/4"	1 1/16"	.575"	1 5/8"	47/64"	1 15/16" +	1.5
80B9	3.35"	2.924"	9	B	3/4"	1 5/16"	.575	1 5/8"	47/64"	2 1/4" +	2.0
80B10	3.68"	3.236"	10	B	3/4"	1 1/2"	.575	1 5/8"	47/64"	2 9/16" +	2.6
80B11	4.01"	3.550"	11	B	3/4"	1 5/8"	.575	1 5/8"	47/64"	2 13/16" +	3.2
80B12	4.33"	3.864"	12	B	3/4"	1 7/8"	.575	1 5/8"	47/64"	3 1/8" +	4.0
80B13	4.66"	4.179"	13	B	3/4"	2"	.575	1 1/2"	47/64"	3"	3.5
80B14	4.98"	4.494"	14	B	3/4"	2 1/4"	.575	1 1/2"	47/64"	3 3/8"	4.3
80B15	5.31"	4.810"	15	B	3/4"	2 1/2"	.575	1 1/2"	47/64"	3 13/16"	5.2
80B16	5.63"	5.126"	16	B	3/4"	2 5/8"	.575	1 1/2"	47/64"	3 7/8"	5.6
80B17	5.95"	5.442"	17	B	3/4"	2 5/8"	.575	1 1/2"	47/64"	4 1/4"	6.0
80B18	6.27"	5.759"	18	B	3/4"	2 3/4"	.575	1 1/2"	47/64"	4 1/4"	7.0
80B19	6.59"	6.076"	19	B	3/4"	2 3/4"	.575	1 1/2"	47/64"	4 1/4"	7.5
80B20	6.91"	6.392"	20	B	3/4"	2 3/4"	.575	1 1/2"	47/64"	4 1/4"	8.0
80B21	7.24"	6.710"	21	B	3/4"	2 3/4"	.575	1 5/8"	1 3/64"	4 1/4"	9.8
80B22	7.56"	7.027"	22	B	3/4"	2 3/4"	.575	1 5/8"	1 3/64"	4 1/4"	10.3
80B23	7.88"	7.344"	23	B	3/4"	2 3/4"	.575	1 5/8"	1 3/64"	4 1/4"	10.9
80B24	8.20"	7.661"	24	B	3/4"	2 3/4"	.575	1 5/8"	1 3/64"	4 1/4"	11.5
80B25	8.52"	7.979"	25	B	3/4"	2 3/4"	.575	1 5/8"	1 3/64"	4 1/4"	12.1
80B26	8.84"	8.296"	26	B	1"	3 1/4"	.575	1 15/16"	1 23/64"	4 3/4"	15.2
80B27	9.16"	8.614"	27	B	1"	3 1/4"	.575	1 15/16"	1 23/64"	4 3/4"	15.9
80B28	9.48"	8.931"	28	B	1"	3 1/4"	.575	1 15/16"	1 23/64"	4 3/4"	16.6
80B29	9.80"	9.249"	29	B	1"	3 1/4"	.575	1 15/16"	1 23/64"	4 3/4"	17.3
80B30	10.11"	9.567"	30	B	1"	3 1/4"	.575	1 15/16"	1 23/64"	4 3/4"	18.1
80B31	10.43"	9.885"	31	B	1"	3 1/4"	.575	1 15/16"	1 23/64"	4 3/4"	18.9
80B32	10.75"	10.202"	32	B	1"	3 1/4"	.575	1 15/16"	1 23/64"	4 3/4"	19.7
80B33	11.07"	10.520"	33	B	1"	3 1/4"	.575	1 15/16"	1 23/64"	4 3/4"	20.5
80B34	11.39"	10.838"	34	B	1"	3 1/4"	.575	1 15/16"	1 23/64"	4 3/4"	21.4
80B35	11.71"	11.156"	35	B	1"	3 1/4"	.575	1 15/16"	1 23/64"	4 3/4"	22.3
80B36	11.98"	11.474"	36	B	1"	3 1/4"	.575	1 15/16"	1 23/64"	4 3/4"	23.2
80B38	12.67"	12.110"	38	B	1"	3 1/4"	.575	1 15/16"	1 23/64"	4 3/4"	25.1
80B39	12.99"	12.428"	39	B	1"	3 1/4"	.575	1 15/16"	1 23/64"	4 3/4"	26.1
80B40	13.31"	12.746"	40	B	1"	3 1/4"	.575	1 15/16"	1 23/64"	4 3/4"	27.2
80B41	13.63"	13.064"	41	B	1"	3 1/4"	.575	1 15/16"	1 23/64"	4 3/4"	28.2
80B42	13.94"	13.382"	42	B	1"	3 1/4"	.575	1 15/16"	1 23/64"	4 3/4"	29.3
80B44	14.58"	14.018"	44	B	1"	3 1/4"	.575	1 15/16"	1 23/64"	4 3/4"	31.5
80B45	14.90"	14.336"	45	B	1"	3 1/4"	.575	1 15/16"	1 23/64"	4 3/4"	32.7
80B46	15.22"	14.654"	46	B	1"	3 1/2"	.575	1 15/16"	1 23/64"	5 1/4"	35.4
80B47	15.54"	14.972"	47	B	1"	3 1/2"	.575	1 15/16"	1 23/64"	5 1/4"	36.6
80B48	15.86"	15.290"	48	B	1"	3 1/2"	.575	1 15/16"	1 23/64"	5 1/4"	37.8
80B49	16.18"	15.608"	49	B	1"	3 1/2"	.575	1 15/16"	1 23/64"	5 1/4"	39.1
80B50	16.50"	15.926"	50	B	1"	3 1/2"	.575	1 15/16"	1 23/64"	5 1/4"	40.3
80B54	17.77"	17.198"	54	B	1"	3 1/2"	.575	1 15/16"	1 23/64"	5 1/4"	45.7
80B60	19.68"	19.107"	60	B	1"	3 1/2"	.575	1 15/16"	1 23/64"	5 1/4"	54.6
80B65	21.27"	20.698"	65	B	1"	3 1/2"	.575	1 15/16"	1 23/64"	5 1/4"	62.7
80C70	22.83"	22.289"	70	C	1"	4 3/8"	.575	2 5/8"	1 1/32"	6 3/8"	81.5
80C72	23.46"	22.926"	72	C	1"	4 3/8"	.575	2 5/8"	1 1/32"	6 3/8"	85.1
80C76	24.74"	24.198"	76	C	1 7/16"	4 3/8"	.575	2 5/8"	1 1/32"	6 3/8"	92.1
80C80	26.05"	25.471"	80	C	1 7/16"	4 3/8"	.575	2 5/8"	1 1/32"	6 3/8"	100
80C84	27.33"	26.744"	84	C	1 7/16"	4 3/8"	.575	2 5/8"	1 1/32"	6 3/8"	109
80C90	29.20"	28.654"	90	C	1 7/16"	4 3/8"	.575	2 5/8"	1 1/32"	6 3/8"	122
80C96	31.15"	30.563"	96	C	1 7/16"	4 3/8"	.575	2 5/8"	1 1/32"	6 3/8"	137
80C112	36.20"	35.655"	112	C	1 7/16"	4 3/8"	.575	2 5/8"	1 1/32"	6 3/8"	180

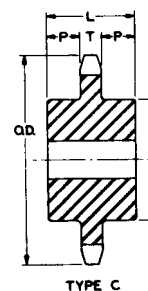
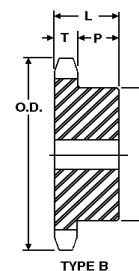

*Maximum bore shown is with standard keyway and setscrew over keyway. Slightly larger bores are possible with no keyway, shallow keyway or set-screw at angle to keyway.

+ Hub is recessed for chain clearance.

These Type "B" and "C" Sprockets are furnished with no keyway and no setscrew. They are made with minimum bore which can be rebored to size, keywayed and setscrewed for a reasonable extra charge.

"B" TYPE SPROCKETS

Steel Single Type "B" and "C" Minimum Bore Sprockets

PART NO.	DIAMETERS		NO. TEETH	TYPE	BORE		DIMENSIONS				WT. LBS.
	OUTSIDE	PITCH			STOCK	MAX. *	T NOM.	L MAX.	P	H	
100B8	3.77"	3.266"	8	B	1"	1 3/8"	.692"	1 7/8"	1 3/16"	2 7/16" +	2.8
100B9	4.18"	3.655"	9	B	1"	1 5/8"	.692"	1 7/8"	1 3/16"	2 13/16" +	3.8
100B10	4.60"	4.045"	10	B	1"	1 7/8"	.692"	1 7/8"	1 3/16"	3 1/4" +	5.1
100B11	5.01"	4.437"	11	B	1"	2 1/4"	.692"	1 7/8"	1 3/16"	3 9/16" +	6.3
100B12	5.42"	4.830"	12	B	1"	2 3/8"	.692"	1 7/8"	1 3/16"	3 7/8" +	5.0
100B13	5.82"	5.223"	13	B	1"	2 5/8"	.692"	1 5/8"	15/16"	3 7/8"	6.3
100B14	6.23"	5.617"	14	B	1"	2 3/4"	.692"	1 5/8"	15/16"	4 3/16"	9.2
100B15	6.63"	6.012"	15	B	1"	3"	.692"	1 3/4"	1 1/16"	4 9/16"	10.5
100B16	7.03"	6.407"	16	B	1"	3 1/4"	.692"	1 3/4"	1 1/16"	4 3/4"	11.2
100B17	7.44"	6.803"	17	B	1"	3 1/4"	.692"	1 3/4"	1 1/16"	4 3/4"	12.0
100B18	7.84"	7.198"	18	B	1"	3 1/4"	.692"	1 3/4"	1 1/16"	4 3/4"	12.9
100B19	8.24"	7.595"	19	B	1"	3 1/4"	.692"	2"	1 5/16"	4 3/4"	15.0
100B20	8.64"	7.991"	20	B	1"	3 1/4"	.692"	2"	1 5/16"	4 3/4"	15.9
100B21	9.04"	8.387"	21	B	1"	3 1/4"	.692"	2"	1 5/16"	4 3/4"	16.9
100B22	9.44"	8.783"	22	B	1"	3 1/4"	.692"	2"	1 5/16"	4 3/4"	18.0
100B23	9.84"	9.180"	23	B	1"	3 1/4"	.692"	2"	1 5/16"	4 3/4"	19.1
100B24	10.25"	9.577"	24	B	1"	3 1/4"	.692"	2"	1 5/16"	4 3/4"	20.2
100B25	10.65"	9.973"	25	B	1"	3 1/4"	.692"	2"	1 5/16"	4 3/4"	21.4
100B26	11.05"	10.370"	26	B	1"	3 1/2"	.692"	2"	1 5/16"	5 1/4"	24.1
100B27	11.4"	10.767"	27	B	1"	3 1/2"	.692"	2"	1 5/16"	5 1/4"	25.4
100B28	11.84"	11.164"	28	B	1"	3 1/2"	.692"	2"	1 5/16"	5 1/4"	26.7
100B29	12.24"	11.561"	29	B	1"	3 1/2"	.692"	2"	1 5/16"	5 1/4"	28.1
100B30	12.64"	11.958"	30	B	1"	3 1/2"	.692"	2"	1 5/16"	5 1/4"	29.6
100B32	13.44"	12.753"	32	B	1"	3 1/2"	.692"	2"	1 5/16"	5 1/4"	32.6
100B35	14.64"	13.945"	35	B	1"	3 1/2"	.692"	2"	1 5/16"	5 1/4"	37.5
100B36	15.04"	14.342"	36	B	1"	3 1/2"	.692"	2"	1 5/16"	5 1/4"	39.2
100B39	16.23"	15.534"	39	B	1"	3 3/4"	.692"	2 3/16"	1 1/2"	6"	48.6
100B40	16.63"	15.932"	40	B	1"	3 3/4"	.692"	2 3/16"	1 1/2"	6"	50.5
100B42	17.43"	16.727"	42	B	1"	3 3/4"	.692"	2 3/16"	1 1/2"	6"	54.5
100B45	18.63"	17.920"	45	B	1"	4"	.692"	2 3/16"	1 1/2"	6"	60.9
100B48	19.82"	19.112"	48	B	1"	4"	.692"	2 3/16"	1 1/2"	6"	67.7
100C54	22.21"	21.498"	54	C	1"	4"	.692"	3 1/4"	1 1/2"	6"	90.8
100C60	24.60"	23.880"	60	C	1"	4"	.692"	3 1/4"	1 1/2"	6"	108
100C70	28.58"	27.862"	70	C	1 7/16"	5 1/4"	.692"	3 1/4"	1 9/32"	7 1/8"	147
100C72	29.38"	28.657"	72	C	1 7/16"	5 1/4"	.692"	3 1/4"	1 9/32"	7 1/8"	155
100C76	30.97"	30.248"	76	C	1 7/16"	5 1/4"	.692"	3 1/4"	1 9/32"	7 1/8"	168
100C80	32.57"	29.850"	80	C	1 7/16"	5 1/4"	.692"	3 1/4"	1 9/32"	7 1/8"	183
100C84	34.16"	33.430"	84	C	1 7/16"	5 1/4"	.692"	3 1/4"	1 9/32"	7 1/8"	199
100C90	36.55"	35.817"	90	C	1 7/16"	5 1/4"	.692"	3 1/4"	1 9/32"	7 1/8"	225
100C96	38.93"	38.203"	96	C	1 7/16"	5 1/4"	.692"	3 1/4"	1 9/32"	7 1/8"	252

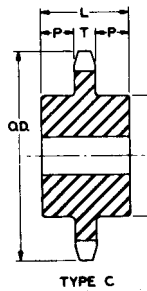
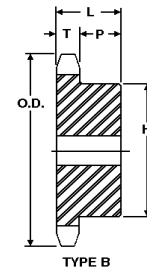

NOTE: Larger "B" & "C" type sprockets and specialty sizes are also available.

*Maximum bore shown is with standard keyway and setscrew over keyway. Slightly larger bores are possible with no keyway, shallow keyway or setscrew at angle to keyway.

+ Hub is recessed for chain clearance.

These Type "B" and "C" Sprockets are furnished with no keyway and no setscrew. They are made with minimum bore which can be rebored to size, keywayed and setscrewed for a reasonable extra charge.

Please contact your nearest Westward Parts branch for availability.

"B" TYPE SPROCKETS

For #100 Roller Chain

Steel Single Type "B" and "C" Minimum Bore Sprockets

PART NO.	DIAMETERS		NO. TEETH	TYPE	BORE		DIMENSIONS				WT. LBS.
	OUT-SIDE	PITCH			STOCK	MAX. *	T NOM.	L MAX.	P	H	
100B8	3.77"	3.266"	8	B	1"	1 3/8"	.692"	1 7/8"	1 3/16"	2 7/16" +	2.8
100B9	4.18"	3.655"	9	B	1"	1 5/8"	.692"	1 7/8"	1 3/16"	2 13/16" +	3.8
100B10	4.60"	4.045"	10	B	1"	1 7/8"	.692"	1 7/8"	1 3/16"	3 1/4" +	5.1
100B11	5.01"	4.437"	11	B	1"	2 1/4"	.692"	1 7/8"	1 3/16"	3 9/16" +	6.3
100B12	5.42"	4.830"	12	B	1"	2 3/8"	.692"	1 7/8"	1 3/16"	3 7/8" +	5.0
100B13	5.82"	5.223"	13	B	1"	2 5/8"	.692"	1 5/8"	15/16"	3 7/8"	6.3
100B14	6.23"	5.617"	14	B	1"	2 3/4"	.692"	1 5/8"	15/16"	4 3/16"	9.2
100B15	6.63"	6.012"	15	B	1"	3"	.692"	1 3/4"	1 1/16"	4 9/16"	10.5
100B16	7.03"	6.407"	16	B	1"	3 1/4"	.692"	1 3/4"	1 1/16"	4 3/4"	11.2
100B17	7.44"	6.803"	17	B	1"	3 1/4"	.692"	1 3/4"	1 1/16"	4 3/4"	12.0
100B18	7.84"	7.198"	18	B	1"	3 1/4"	.692"	1 3/4"	1 1/16"	4 3/4"	12.9
100B19	8.24"	7.595"	19	B	1"	3 1/4"	.692"	2"	1 5/16"	4 3/4"	15.0
100B20	8.64"	7.991"	20	B	1"	3 1/4"	.692"	2"	1 5/16"	4 3/4"	15.9
100B21	9.04"	8.387"	21	B	1"	3 1/4"	.692"	2"	1 5/16"	4 3/4"	16.9
100B22	9.44"	8.783"	22	B	1"	3 1/4"	.692"	2"	1 5/16"	4 3/4"	18.0
100B23	9.84"	9.180"	23	B	1"	3 1/4"	.692"	2"	1 5/16"	4 3/4"	19.1
100B24	10.25"	9.577"	24	B	1"	3 1/4"	.692"	2"	1 5/16"	4 3/4"	20.2
100B25	10.65"	9.973"	25	B	1"	3 1/4"	.692"	2"	1 5/16"	4 3/4"	21.4
100B26	11.05"	10.370"	26	B	1"	3 1/2"	.692"	2"	1 5/16"	5 1/4"	24.1
100B27	11.4"	10.767"	27	B	1"	3 1/2"	.692"	2"	1 5/16"	5 1/4"	25.4
100B28	11.84"	11.164"	28	B	1"	3 1/2"	.692"	2"	1 5/16"	5 1/4"	26.7
100B29	12.24"	11.561"	29	B	1"	3 1/2"	.692"	2"	1 5/16"	5 1/4"	28.1
100B30	12.64"	11.958"	30	B	1"	3 1/2"	.692"	2"	1 5/16"	5 1/4"	29.6
100B32	13.44"	12.753"	32	B	1"	3 1/2"	.692"	2"	1 5/16"	5 1/4"	32.6
100B35	14.64"	13.945"	35	B	1"	3 1/2"	.692"	2"	1 5/16"	5 1/4"	37.5
100B36	15.04"	14.342"	36	B	1"	3 1/2"	.692"	2"	1 5/16"	5 1/4"	39.2
100B39	16.23"	15.534"	39	B	1"	3 3/4"	.692"	2 3/16"	1 1/2"	6"	48.6
100B40	16.63"	15.932"	40	B	1"	3 3/4"	.692"	2 3/16"	1 1/2"	6"	50.5
100B42	17.43"	16.727"	42	B	1"	3 3/4"	.692"	2 3/16"	1 1/2"	6"	54.5
100B45	18.63"	17.920"	45	B	1"	4"	.692"	2 3/16"	1 1/2"	6"	60.9
100B48	19.82"	19.112"	48	B	1"	4"	.692"	2 3/16"	1 1/2"	6"	67.7
100C54	22.21"	21.498"	54	C	1"	4"	.692"	3 1/4"	1 1/2"	6"	90.8
100C60	24.60"	23.880"	60	C	1"	4"	.692"	3 1/4"	1 1/2"	6"	108
100C70	28.58"	27.862"	70	C	1 7/16"	5 1/4"	.692"	3 1/4"	1 9/32"	7 1/8"	147
100C72	29.38"	28.657"	72	C	1 7/16"	5 1/4"	.692"	3 1/4"	1 9/32"	7 1/8"	155
100C76	30.97"	30.248"	76	C	1 7/16"	5 1/4"	.692"	3 1/4"	1 9/32"	7 1/8"	168
100C80	32.57"	29.850"	80	C	1 7/16"	5 1/4"	.692"	3 1/4"	1 9/32"	7 1/8"	183
100C84	34.16"	33.430"	84	C	1 7/16"	5 1/4"	.692"	3 1/4"	1 9/32"	7 1/8"	199
100C90	36.55"	35.817"	90	C	1 7/16"	5 1/4"	.692"	3 1/4"	1 9/32"	7 1/8"	225
100C96	38.93"	38.203"	96	C	1 7/16"	5 1/4"	.692"	3 1/4"	1 9/32"	7 1/8"	252

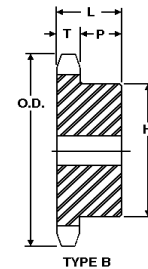

TYPE B

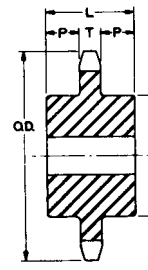

TYPE C

NOTE: Larger "B" & "C" type sprockets and specialty sizes are also available.

*Maximum bore shown is with standard keyway and setscrew over keyway. Slightly larger bores are possible with no keyway, shallow keyway or setscrew at angle to keyway.

+ Hub is recessed for chain clearance.

These Type "B" and "C" Sprockets are furnished with no keyway and no setscrew. They are made with minimum bore which can be rebored to size, keywayed and setscrewed for a reasonable extra charge.

Please contact your nearest Westward Parts branch for availability.

FINISHED BORE CHAIN SPROCKETS

40 Roller Chain Sprockets 1/2" Pitch

No. 40 Single/Finished Bore Steel Sprockets

PART NO.	DIAMETERS		NO. TEETH	TYPE	STOCK BORES MARKED "X"											DIMENSIONS			WT. LBS
	OUTSIDE	PITCH			1/2	5/8	3/4	7/8	1	1 1/8	1 3/16	1 1/4	1 3/8	1 7/16	1 1/2	T NOM.	L MAX.	P	
PTP 40B10	1.84	1.618	10	1	-	x	x	-	-	-	-	-	-	-	.284	7/8	19/32	.2	
PTP 40B11	2.00	1.775	11	1	x	x	x	x	-	-	-	-	-	-	.284	7/8	19/32	.4	
PTP 40B12	2.17	1.932	12	1	x	x	x	x	x	-	-	-	-	-	.284	7/8	19/32	.4	
PTP 40B13	2.30	2.089	13	1	x	x	x	x	x	-	-	-	-	-	.284	7/8	19/32	.5	
PTP 40B14	2.49	2.247	14	1	x	x	x	x	x	x	-	-	-	-	.284	7/8	19/32	.6	
PTP 40B15	2.65	2.405	15	1	x	x	x	x	x	x	x	-	-	-	.284	7/8	19/32	.7	
PTP 40B16	2.80	2.563	16	1	-	x	x	x	x	x	x	x	-	-	.284	7/8	19/32	.8	
PTP 40B17	2.96	2.721	17	1	-	x	x	x	x	x	x	x	-	-	.284	7/8	19/32	1.1	
PTP 40B18	3.14	2.879	18	1	-	x	x	x	x	x	x	x	-	-	.284	7/8	19/32	1.1	
PTP 40B19	3.30	3.038	19	1	-	x	x	x	x	x	x	x	-	-	.284	7/8	19/32	1.2	
PTP 40B20	3.45	3.196	20	1	-	x	x	x	x	x	x	x	-	-	.284	15/16	21/32	1.4	

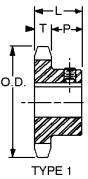

Note: • Specify bore size when ordering (example - PTP 40B10-1 for 1" bore)
 • X indicates normal stock sizes
 • Other bore sizes available on special order
 • Sizes larger than 20 teeth available on special order

50 Roller Chain Sprockets 5/8" Pitch

No. 50 Single/Finished Bore Steel Sprockets

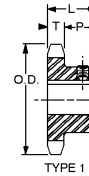

PART NO.	DIAMETERS		NO. TEETH	TYPE	STOCK BORES MARKED "X"												DIMENSIONS			WT. LBS
	OUTSIDE	PITCH			5/8	3/4	7/8	1	1 1/8	1 3/16	1 1/4	1 3/8	1 7/16	1 1/2	1 5/8	1 3/4	1 15/16	T NOM.	L MAX.	
PTP 50B10	2.30	2.023	10	1	x	x	x	x	-	-	-	-	-	-	-	-	.343	1	21/32	.5
PTP 50B11	2.50	2.219	11	1	x	x	x	x	-	-	-	-	-	-	-	-	.343	1	21/32	.6
PTP 50B12	2.70	2.415	12	1	x	x	x	x	x	-	x	-	-	-	-	-	.343	1	21/32	.8
PTP 50B13	2.91	2.612	13	1	x	x	x	x	x	x	x	-	-	-	-	-	.343	1	21/32	.8
PTP 50B14	3.11	2.809	14	1	x	x	x	x	x	x	x	-	-	-	-	-	.343	1	21/32	1.0
PTP 50B15	3.32	3.006	15	1	x	x	x	x	x	x	x	x	-	-	-	-	.343	1	21/32	1.3
PTP 50B16	3.52	3.204	16	1	x	x	x	x	x	x	x	x	x	-	-	-	.343	1	21/32	1.5
PTP 50B17	3.72	3.401	17	1	x	x	x	x	x	x	x	x	x	-	-	-	.343	1	21/32	1.6
PTP 50B18	3.92	3.599	18	1	x	x	x	x	x	x	x	x	x	-	-	-	.343	1	21/32	1.8
PTP 50B19	4.12	3.797	19	1	x	x	x	x	x	x	x	x	x	-	-	-	.343	1	21/32	1.9
PTP 50B20	4.32	3.995	20	1	x	x	x	x	x	x	x	x	x	-	-	-	.343	1	21/32	2.4

Note: • Specify bore size when ordering (example - PTP 40B10-1 for 1" bore)
 • X indicates normal stock sizes
 • Other bore sizes available on special order
 • Sizes larger than 20 teeth available on special order

FINISHED BORE CHAIN SPROCKETS

60 Roller Chain Sprockets 3/4" Pitch

No. 60 Single/Finished Bore Steel Sprockets

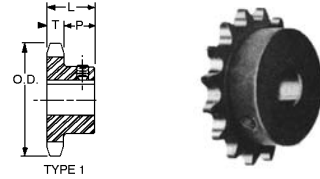

PART NO.	DIAMETERS		NO. TEETH	TYPE	STOCK BORES MARKED "X"																DIMENSIONS			WT. LBS
	OUTSIDE	PITCH			5/8	3/4	7/8	1	1 1/8	1 3/16	1 1/4	1 3/8	1 7/16	1 1/2	1 5/8	1 3/4	1 15/16	2	2 3/16	2 7/16	T NOM.	L MAX.	P	
PTP 60B10	2.76	2.427	10	1	X	X	-	X	-	-	-	-	-	-	-	-	-	-	-	-	.459	1 3/16	47/64	.6
PTP 60B11	2.96	2.662	11	1	-	X	-	X	X	X	X	-	-	-	-	-	-	-	-	-	.459	1 3/16	47/64	1.0
PTP 60B12	3.25	2.898	12	1	-	X	X	X	X	X	X	-	-	-	-	-	-	-	-	-	.459	1 3/16	47/64	1.3
PTP 60B13	3.45	3.134	13	1	-	X	X	X	X	X	X	X	X	-	-	-	-	-	-	-	.459	1 3/16	47/64	2.0
PTP 60B14	3.74	3.371	14	1	-	X	X	X	X	X	X	X	X	-	-	-	-	-	-	-	.459	1 3/16	47/64	2.4
PTP 60B15	3.98	3.607	15	1	-	X	X	X	X	X	X	X	X	-	-	-	-	-	-	-	.459	1 3/16	47/64	2.6
PTP 60B16	4.22	3.844	16	1	-	X	X	X	X	X	X	X	X	-	X	X	X	-	-	-	.459	1 3/16	47/64	3.4
PTP 60B17	4.46	4.082	17	1	-	-	-	X	X	X	X	X	X	-	X	X	X	-	-	-	.459	1 3/16	47/64	3.7
PTP 60B18	4.70	4.319	18	1	-	-	-	X	X	X	X	X	X	-	X	X	X	-	-	-	.459	1 3/16	47/64	4.1
PTP 60B19	4.95	4.557	19	1	-	-	-	X	X	X	X	X	X	-	X	X	X	-	-	-	.459	1 3/16	47/64	5.1
PTP 60B20	5.19	4.794	20	1	-	-	-	X	X	X	X	X	X	-	X	X	X	-	-	-	.459	1 3/16	47/64	5.4

- Note:
- Specify bore size when ordering (example - PTP 40B10-1 for 1" bore)
 - X indicates normal stock sizes
 - Other bore sizes available on special order
 - Sizes larger than 20 teeth available on special order

80 Roller Chain Sprockets 1" Pitch

No. 80 Single/Finished Bore Steel Sprockets

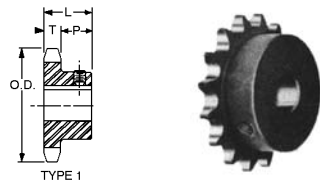

PART NO.	DIAMETERS		NO. TEETH	TYPE	STOCK BORES MARKED "X"																DIMENSIONS			WT. LBS
	OUTSIDE	PITCH			1	1 1/8	1 3/16	1 1/4	1 3/8	1 7/16	1 1/2	1 5/8	1 3/4	1 7/8	1 15/16	2	2 3/16	2 7/16	2 15/16	T NOM.	L MAX.	P		
PTP 80B10	3.68	3.236	10	1	x	-	x	-	-	-	-	-	-	-	-	-	-	-	-	.575	1 5/8	1 3/64	1.5	
PTP 80B11	4.01	3.550	11	1	x	x	x	x	x	x	x	-	-	-	-	-	-	-	-	.575	1 5/8	1 3/64	2.2	
PTP 80B12	4.33	3.864	12	1	x	x	x	x	x	x	x	x	-	-	-	-	-	-	-	.575	1 5/8	1 3/64	2.6	
PTP 80B13	4.66	4.179	13	1	x	x	x	x	x	x	x	x	-	x	-	-	-	-	-	.575	1 1/2	59/64	3.4	
PTP 80B14	4.98	4.494	14	1	x	x	x	x	x	x	x	x	-	x	-	-	-	-	-	.575	1 1/2	59/64	4.0	
PTP 80B16	5.63	5.126	16	1	x	-	x	x	x	x	x	x	-	x	-	-	-	-	-	.575	1 1/2	59/64	6.1	
PTP 80B17	5.95	5.442	17	1	x	-	x	x	x	x	x	x	-	x	-	-	-	-	-	.575	1 1/2	59/64	7.5	
PTP 80B18	6.27	5.759	18	1	x	-	x	x	x	x	x	x	-	x	-	-	-	-	-	.575	1 1/2	59/64	8.2	
PTP 80B19	6.59	6.076	19	1	x	-	x	x	x	x	x	x	-	x	x	x	-	-	-	.575	1 5/8	1 3/64	8.5	
PTP 80B20	6.91	6.392	20	1	x	-	x	x	x	x	x	x	-	x	x	x	-	-	-	.575	1 5/8	1 3/64	8.9	

- Note:
- Specify bore size when ordering (example - PTP 40B10-1 for 1" bore)
 - X indicates normal stock sizes
 - Other bore sizes available on special order
 - Sizes larger than 20 teeth available on special order

BUSHED SPROCKETS

For #40 Roller Chain

Steel Single Sprockets with Split Taper Bushings

PART NO.	BUSHING	BORE RANGE	DIAMETERS		NO. TEETH	TYPE	DIMENSIONS						WT. LESS BUSHING
			OUTSIDE	PITCH			T NOM.	OL	L	P	C	H	
40G12	G	3/8" - 1"	2.17"	1.932"	12	3	.284"	1 1/2"	1"	1 1/32"	5/16"	2"	.3
40G13	G	3/8" - 1"	2.30"	2.089"	13	3	.284	1 1/2"	1"	1 1/32"	5/16"	2"	.4
40G14	G	3/8" - 1"	2.49"	2.247"	14	3	.284	1 1/2"	1"	1 1/32"	5/16"	2"	.5
40G15	H	3/8" - 1 1/2"	2.65"	2.405"	15	3	.284	1 19/32"	1 1/4"	1 1/8"	5/32"	2 1/2"	.5
40G16	G	3/8" - 1"	2.80"	2.563"	16	3	.284	1 1/4"	1"	25/32"	1/16"	2"	.4
40H16	H	3/8" - 1 1/2"	2.80"	2.563"	16	3	.284	1 19/32"	1 1/4"	1 1/8"	5/32"	2 1/2"	.6
40H17	H	3/8" - 1 1/2"	2.96"	2.721"	17	3	.284	1 1/2"	1 1/4"	1 1/32"	1/16"	2 1/2"	.6
40H18	H	3/8" - 1 1/2"	3.14"	2.879"	18	3	.284	1 1/2"	1 1/4"	1 1/32"	1/16"	2 1/2"	.7
40P18	P1	1/2" - 1 3/4"	3.14"	2.879"	18	4	.284	2 3/16"	1 15/16"	1 21/32"	0	3"	1.2
40H19	H	3/8" - 1 1/2"	3.30"	3.038"	19	3	.284	1 1/2"	1 1/4"	1 1/32"	1/16"	2 1/2"	.8
40P19	P1	1/2" - 1 3/4"	3.30"	3.038"	19	4	.284	2 3/16"	1 15/16"	1 21/32"	0	3"	1.3
40H20	H	3/8" - 1 1/2"	3.45"	3.196"	20	3	.284	1 1/2"	1 1/4"	1 1/32"	1/16"	2 1/2"	.8
40P20	P1	1/2" - 1 3/4"	3.45"	3.196"	20	4	.284	2 3/16"	1 15/16"	1 21/32"	0	3"	1.3
40H21	H	3/8" - 1 1/2"	3.62"	3.355"	21	3	.284	1 1/2"	1 1/4"	1 1/32"	1/16"	2 1/2"	.9
40P21	P1	1/2" - 1 3/4"	3.62"	3.355"	21	4	.284	2 3/16"	1 15/16"	1 21/32"	0	3"	1.5
40H22	H	3/8" - 1 1/2"	3.75"	3.513"	22	3	.284	1 1/2"	1 1/4"	1 1/32"	1/16"	2 1/2"	.9
40P22	P1	1/2" - 1 3/4"	3.75"	3.513"	22	4	.284	2 3/16"	1 15/16"	1 21/32"	0	3"	.6
40H23	H	3/8" - 1 1/2"	3.94"	3.672"	23	3	.284	1 1/2"	1 1/4"	1 1/32"	1/16"	2 1/2"	1.0
40P23	P1	1/2" - 1 3/4"	3.94"	3.672"	23	4	.284	2 3/16"	1 15/16"	1 21/32"	0	3"	1.7
40H24	H	3/8" - 1 1/2"	4.10"	3.831"	24	3	.284	1 1/2"	1 1/4"	1 1/32"	1/16"	2 1/2"	1.2
40P24	P1	1/2" - 1 3/4"	4.10"	3.831"	24	4	.284	2 3/16"	1 15/16"	1 21/32"	0	3"	1.8
40H25	H	3/8" - 1 1/2"	4.26"	3.989"	25	3	.284	1 1/2"	1 1/4"	1 1/32"	1/16"	2 1/2"	1.3
40P25	P1	1/2" - 1 3/4"	4.26"	3.989"	25	4	.284	2 3/16"	1 15/16"	1 21/32"	0	3"	2.0
40H26	H	3/8" - 1 1/2"	4.42"	4.148"	26	3	.284	1 1/2"	1 1/4"	1 1/32"	1/16"	2 1/2"	1.4
40P26	P1	1/2" - 1 3/4"	4.42"	4.148"	26	4	.284	2 3/16"	1 15/16"	1 21/32"	0	3"	2.0
40H27	H	3/8" - 1 1/2"	4.58"	4.307"	27	3	.284	1 1/2"	1 1/4"	1 1/32"	1/16"	2 1/2"	1.4
40P27	P1	1/2" - 1 3/4"	4.58"	4.307"	27	4	.284	2 3/16"	1 15/16"	1 21/32"	0	3"	2.1
40H28	H	3/8" - 1 1/2"	4.74"	4.466"	28	3	.284	1 1/2"	1 1/4"	1 1/32"	1/16"	2 1/2"	1.5
40P28	P1	1/2" - 1 3/4"	4.74"	4.466"	28	4	.284	2 3/16"	1 15/16"	1 21/32"	0	3"	2.2
40P29	P1	1/2" - 1 3/4"	4.90"	4.625"	29	4	.284	2 3/16"	1 15/16"	1 21/32"	0	3"	2.3
40H30	H	3/8" - 1 1/2"	5.06"	4.783"	30	3	.284	1 1/2"	1 1/4"	1 1/32"	1/16"	2 1/2"	1.6
40P30	P1	1/2" - 1 3/4"	5.06"	4.783"	30	4	.284	2 3/16"	1 15/16"	1 21/32"	0	3"	2.4
40P31	P1	1/2" - 1 3/4"	5.22"	4.942"	31	4	.284	2 3/16"	1 15/16"	1 21/32"	0	3"	2.5
40P32	P1	1/2" - 1 3/4"	5.38"	5.101"	32	4	.284	2 3/16"	1 15/16"	1 21/32"	0	3"	2.6
40P33	P1	1/2" - 1 3/4"	5.54"	5.260"	33	4	.284	2 3/16"	1 15/16"	1 21/32"	0	3"	2.6
40P34	P1	1/2" - 1 3/4"	5.70"	5.419"	34	4	.284	2 3/16"	1 15/16"	1 21/32"	0	3"	2.8
40P35	P1	1/2" - 1 3/4"	5.86"	5.578"	35	4	.284	2 3/16"	1 15/16"	1 21/32"	0	3"	2.9
40P36	P1	1/2" - 1 3/4"	6.02"	5.737"	36	4	.284	2 3/16"	1 15/16"	1 21/32"	0	3"	3.1
40P37	P1	1/2" - 1 3/4"	6.18"	5.896"	37	4	.284	2 3/16"	1 15/16"	1 21/32"	0	3"	3.3
40P38	P1	1/2" - 1 3/4"	6.33"	6.055"	38	4	.284	2 3/16"	1 15/16"	1 21/32"	0	3"	3.3
40P40	P1	1/2" - 1 3/4"	6.65"	6.373"	40	4	.284	2 3/16"	1 15/16"	1 21/32"	0	3"	3.5
40P41	P1	1/2" - 1 3/4"	6.81"	6.532"	41	4	.284	2 3/16"	1 15/16"	1 21/32"	0	3"	3.6
40P42	P1	1/2" - 1 3/4"	6.97"	6.691"	42	4	.284	2 3/16"	1 15/16"	1 21/32"	0	3"	3.9
40P44	P1	1/2" - 1 3/4"	7.29"	7.009"	44	4	.284	2 3/16"	1 15/16"	1 21/32"	0	3"	4.0
40P45	P1	1/2" - 1 3/4"	7.45"	7.168"	45	4	.284	2 3/16"	1 15/16"	1 21/32"	0	3"	4.2
40P47	P1	1/2" - 1 3/4"	7.77"	7.486"	47	4	.284	2 3/16"	1 15/16"	1 21/32"	0	3"	4.6
40P48	P1	1/2" - 1 3/4"	7.93"	7.645"	48	4	.284	2 3/16"	1 15/16"	1 21/32"	0	3"	4.8
40P50	P1	1/2" - 1 3/4"	8.25"	7.963"	50	4	.284	2 3/16"	1 15/16"	1 21/32"	0	3"	5.0
40P54	P1	1/2" - 1 3/4"	8.89"	8.599"	54	4	.284	2 3/16"	1 15/16"	1 21/32"	0	3"	5.5
40P56	P1	1/2" - 1 3/4"	9.20"	8.917"	56	4	.284	2 3/16"	1 15/16"	1 21/32"	0	3"	5.9
40P60	P1	1/2" - 1 3/4"	9.84"	9.554"	60	4	.284	2 3/16"	1 15/16"	1 21/32"	0	3"	6.6
40Q60	Q1	3/4" - 2 11/16"	9.84"	9.554"	60	4	.284	2 25/32"	2 1/2"	2 7/32"	0	4 1/8"	8.8
40P70	P1	1/2" - 1 3/4"	11.43"	11.145"	70	4	.284	2 3/16"	1 15/16"	1 21/32"	0	3"	8.6
40Q70	Q1	3/4" - 2 11/16"	11.43"	11.145"	70	4	.284	2 25/32"	2 1/2"	2 7/32"	0	4 1/8"	11.0
40Q72	Q1	3/4" - 2 11/16"	11.75"	11.463"	72	4	.284	2 25/32"	2 1/2"	2 7/32"	0	4 1/8"	11.2
40Q80	Q1	3/4" - 2 11/16"	13.03"	12.736"	80	4	.284	2 25/32"	2 1/2"	2 7/32"	0	4 1/8"	13.1
40Q84	Q1	3/4" - 2 11/16"	13.66"	13.372"	84	4	.284	2 25/32"	2 1/2"	2 7/32"	0	4 1/8"	14.1
40Q96	Q1	3/4" - 2 11/16"	15.57"	15.281"	96	4	.284	2 25/32"	2 1/2"	2 7/32"	0	4 1/8"	17.3
40Q112	Q1	3/4" - 2 11/16"	18.12"	17.828"	112	4	.284	2 25/32"	2 1/2"	2 7/32"	0	4 1/8"	12.8

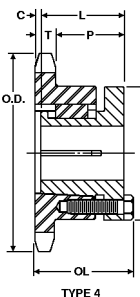
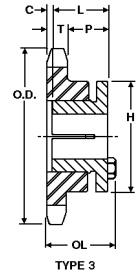

Standard Keyseats
Table No. 3

BORE RANGE	KEYSEAT
3/8" - 7/16"	None
1/2" - 9/16"	1/8" - 1/16"
5/8" - 7/8"	3/16" - 3/32"
15/16" - 1 1/4"	1/4" - 1/8"
1 5/16" - 1 3/8"	5/16" - 5/32"
1 7/16" - 1 3/4"	3/8" - 3/16"

1 3/8" Bore Bushings also available with 3/8" x 3/16" keyseat.

Where two sprockets with the same number of teeth but different bushings are offered, we suggest using the sprocket bushing for heavier service drives.

See pages 28-32
for Bushings

BUSHED SPROCKETS

For #50 Roller Chain

Steel Single Sprockets with Split Taper Bushings

PART NO.	BUSHING	DIAMETERS			NO. TEETH	TYPE	DIMENSIONS						WT. LESS BUSHING
		BORE RANGE	OUTSIDE	PITCH			T NOM.	OL	L	P	C	H	
50G11	G	3/8" - 1"	2.50"	2.219	11	3	.343"	1 19/32"	1"	1 1/16"	13/32"	2"	.5
50G12	G	3/8" - 1"	2.70"	2.415	12	3	.343	1 19/32"	1"	1 1/16"	13/32"	2"	.5
50H13	H	3/8" - 1 1/2"	2.91"	2.612	13	3	.343	1 21/32"	1 1/4"	1 1/8"	7/32"	2 1/2"	.6
50H14	H	3/8" - 1 1/2"	3.11"	2.809	14	3	.343	1 19/32"	1 1/4"	1 1/16"	5/32"	2 1/2"	.6
50H15	H	3/8" - 1 1/2"	3.32"	3.006	15	3	.343	1 1/2"	1 1/4"	1 1/16"	5/32"	2 1/2"	.8
50P15	P1	1/2" - 1 3/4"	3.32"	3.006	15	4	.343	2 3/16"	1 15/16"	1 19/32"	0	3"	1.1
50H16	H	3/8" - 1 1/2"	3.52"	3.204	16	3	.343	1 1/2"	1 1/4"	1 1/16"	5/32"	2 1/2"	.9
50P16	P1	1/2" - 1 3/4"	3.52"	3.204	16	4	.343	2 3/16"	1 15/16"	1 19/32"	0	3"	1.3
50H17	H	3/8" - 1 1/2"	3.72"	3.401	17	3	.343	1 1/2"	1 1/4"	1 1/16"	5/32"	2 1/2"	1.0
50P17	P1	1/2" - 1 3/4"	3.72"	3.401	17	4	.343	2 3/16"	1 15/16"	1 19/32"	0	3"	1.4
50H18	H	3/8" - 1 1/2"	3.92"	3.599	18	3	.343	1 1/2"	1 1/4"	1 1/16"	5/32"	2 1/2"	1.0
50P18	P1	1/2" - 1 3/4"	3.92"	3.599	18	4	.343	2 3/16"	1 15/16"	1 19/32"	0	3"	1.6
50H19	H	3/8" - 1 1/2"	4.12"	3.797	19	3	.343	1 1/2"	1 1/4"	31/32"	1/16"	2 1/2"	1.1
50P19	P1	1/2" - 1 3/4"	4.12"	3.797	19	4	.343	2 3/16"	1 15/16"	1 19/32"	0	3"	1.8
50H20	H	3/8" - 1 1/2"	4.32"	3.995	20	3	.343	1 1/2"	1 1/4"	31/32"	1/16"	2 1/2"	1.5
50P20	P1	1/2" - 1 3/4"	4.32"	3.995	20	4	.343	2 3/16"	1 15/16"	1 19/32"	0	3"	2.0
50P21	P1	1/2" - 1 3/4"	4.52"	4.194	21	4	.343	2 3/16"	1 15/16"	1 19/32"	0	3"	2.1
50P22	P1	1/2" - 1 3/4"	4.70"	4.392	22	4	.343	2 3/16"	1 15/16"	1 19/32"	0	3"	2.3
50P23	P1	1/2" - 1 3/4"	4.92"	4.599	23	4	.343	2 3/16"	1 15/16"	1 19/32"	0	3"	2.4
50Q23	Q1	3/4" - 2 11/16"	4.92"	3.599	23	4	.343	2 25/32"	2 1/2"	2 5/32"	0	4 1/8"	3.4
50P24	P1	1/2" - 1 3/4"	5.12"	4.788	24	4	.343	2 3/16"	1 15/16"	1 19/32"	0	3"	2.5
50Q24	Q1	3/4" - 2 11/16"	5.12"	4.788	24	4	.343	2 25/32"	2 1/2"	2 5/32"	0	4 1/8"	3.4
50P25	P1	1/2" - 1 3/4"	5.32"	4.987	25	4	.343	2 3/16"	1 15/16"	1 19/32"	0	3"	2.6
50Q25	Q1	3/4" - 2 11/16"	5.32"	4.987	25	4	.343	2 25/32"	2 1/2"	2 5/32"	0	4 1/8"	3.7
50P26	P1	1/2" - 1 3/4"	5.52"	5.185	26	4	.343	2 3/16"	1 15/16"	1 19/32"	0	3"	2.9
50Q26	Q1	3/4" - 2 11/16"	5.52"	5.185	26	4	.343	2 25/32"	2 1/2"	2 5/32"	0	4 1/8"	3.8
50P27	P1	1/2" - 1 3/4"	5.72"	5.384	27	4	.343	2 3/16"	1 15/16"	1 19/32"	0	3"	3.0
50Q27	Q1	3/4" - 2 11/16"	5.72"	5.384	27	4	.343	2 25/32"	2 1/2"	2 5/32"	0	4 1/8"	3.9
50P28	P1	1/2" - 1 3/4"	5.92"	5.582	28	4	.343	2 3/16"	1 15/16"	1 19/32"	0	3"	3.2
50Q28	Q1	3/4" - 2 11/16"	5.92"	5.582	28	4	.343	2 25/32"	2 1/2"	2 5/32"	0	4 1/8"	4.0
50P29	P1	1/2" - 1 3/4"	6.12"	5.781	29	4	.343	2 3/16"	1 15/16"	1 19/32"	1/16"	3"	3.3
50P30	P1	1/2" - 1 3/4"	6.32"	5.979	30	4	.343	2 3/16"	1 15/16"	1 19/32"	0	3"	3.5
50Q30	Q1	3/4" - 2 11/16"	6.32"	5.979	30	4	.343	2 25/32"	2 1/2"	2 5/32"	0	4 1/8"	5.6
50P31	P1	1/2" - 1 3/4"	6.52"	6.178	31	4	.343	2 3/16"	1 15/16"	1 19/32"	0	3"	3.6
50P32	P1	1/2" - 1 3/4"	6.72"	6.376	32	4	.343	2 3/16"	1 15/16"	1 19/32"	0	3"	3.9
50Q32	Q1	3/4" - 2 11/16"	6.72"	6.376	32	4	.343	2 25/32"	2 1/2"	2 5/32"	0	3"	6.1
50P33	P1	1/2" - 1 3/4"	6.92"	6.575	33	4	.343	2 3/16"	1 15/16"	1 19/32"	0	4 1/8"	4.1
50P34	P1	1/2" - 1 3/4"	7.12"	6.774	34	4	.343	2 3/16"	1 15/16"	1 19/32"	0	4 1/8"	4.3
50P35	P1	1/2" - 1 3/4"	7.32"	6.972	35	4	.343	2 3/16"	1 15/16"	1 19/32"	0	4 1/8"	4.3
50Q35	Q1	3/4" - 2 11/16"	7.32"	6.972	35	4	.343	2 25/32"	2 1/2"	2 5/32"	0	4 1/8"	6.8
50P36	P1	1/2" - 1 3/4"	7.52"	7.171	36	4	.343	2 3/16"	1 15/16"	1 19/32"	0	4 1/8"	4.8
50Q36	Q1	3/4" - 2 11/16"	7.52"	7.171	36	4	.343	2 25/32"	2 1/2"	2 5/32"	0	4 1/8"	6.8
50Q37	Q1	3/4" - 2 11/16"	7.72"	7.370	37	4	.343	2 25/32"	2 1/2"	2 5/32"	0	4 1/8"	7.0
50Q38	Q1	3/4" - 2 11/16"	7.92"	7.569	38	4	.343	2 25/32"	2 1/2"	2 5/32"	0	4 1/8"	7.4
50Q39	Q1	3/4" - 2 11/16"	8.12"	7.767	39	4	.343	2 25/32"	2 1/2"	2 5/32"	0	4 1/8"	7.6
50Q40	Q1	3/4" - 2 11/16"	8.32"	7.966	40	4	.343	2 25/32"	2 1/2"	2 5/32"	0	4 1/8"	8.0
50Q41	Q1	3/4" - 2 11/16"	8.52"	8.165	41	4	.343	2 25/32"	2 1/2"	2 5/32"	0	4 1/8"	8.2
50Q42	Q1	3/4" - 2 11/16"	8.72"	8.363	42	4	.343	2 25/32"	2 1/2"	2 5/32"	0	4 1/8"	8.3
50Q44	Q1	3/4" - 2 11/16"	9.11"	8.761	44	4	.343	2 25/32"	2 1/2"	2 5/32"	0	4 1/8"	8.6
50Q45	Q1	3/4" - 2 11/16"	9.31"	8.960	45	4	.343	2 25/32"	2 1/2"	2 5/32"	0	4 1/8"	9.0
50Q47	Q1	3/4" - 2 11/16"	9.71"	9.357	47	4	.343	2 25/32"	2 1/2"	2 5/32"	0	4 1/8"	9.3
50Q48	Q1	3/4" - 2 11/16"	9.91"	9.556	48	4	.343	2 25/32"	2 1/2"	2 5/32"	0	4 1/8"	9.6
50Q50	Q1	3/4" - 2 11/16"	10.31"	9.954	50	4	.343	2 25/32"	2 1/2"	2 5/32"	0	4 1/8"	9.8
50Q54	Q1	3/4" - 2 11/16"	11.11"	10.749	54	4	.343	2 25/32"	2 1/2"	2 5/32"	0	4 1/8"	11.3
50Q56	Q1	3/4" - 2 11/16"	11.50"	11.147	56	4	.343	2 25/32"	2 1/2"	2 5/32"	0	4 1/8"	12.3
50Q60	Q1	3/4" - 2 11/16"	12.30"	11.942	60	4	.343	2 25/32"	2 1/2"	2 5/32"	0	4 1/8"	13.3
50Q70	Q1	3/4" - 2 11/16"	14.29"	13.931	70	4	.343	2 25/32"	2 1/2"	2 5/32"	0	4 1/8"	16.9
50Q72	Q1	3/4" - 2 11/16"	14.69"	14.429	72	4	.343	2 25/32"	2 1/2"	2 5/32"	0	4 1/8"	18.1
50Q80	Q1	3/4" - 2 11/16"	16.28"	15.920	80	4	.343	2 25/32"	2 1/2"	2 5/32"	0	4 1/8"	21.1
50Q84	Q1	3/4" - 2 11/16"	17.08"	16.715	84	4	.343	2 25/32"	2 1/2"	2 5/32"	0	4 1/8"	24.3
50Q96	Q1	3/4" - 2 11/16"	19.47"	19.102	96	4	.343	2 25/32"	2 1/2"	2 5/32"	0	4 1/8"	29.8
50Q112	Q1	3/4" - 2 11/16"	22.65"	22.285	112	4	.343	2 25/32"	2 1/2"	2 5/32"	0	4 1/8"	39.3

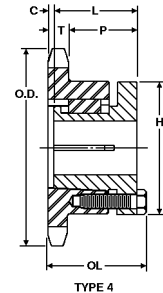
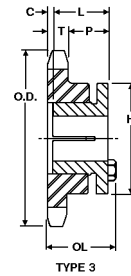
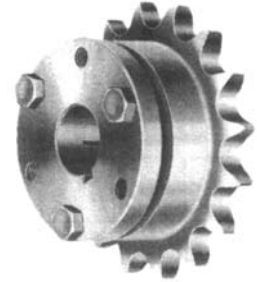

Standard Keyseats Table No. 3

BORE RANGE	KEYSEAT
3/8" - 7/16"	None
1/2" - 9/16"	1/8" - 1/16"
5/8" - 7/8"	3/16" - 3/32"
15/16" - 1 1/4"	1/4" - 1/8"
1 5/16" - 1 3/8"	5/16" - 5/32"
1 7/16" - 1 3/4"	3/8" - 3/16"
1 13/16" - 2 1/4"	1/2" - 1/4"
2 15/16" - 2 3/4"	5/8" - 5/16"
2 13/16" - 3 1/4"	3/4" - 3/8"

1 3/8" Bore Bushings also available with 3/8" x 3/16" keyseat.

Where two sprockets with the same number of teeth but different bushings are offered, we suggest using the sprocket bushing for heavier service drives.

See pages 28-32 for Bushings

BUSHED SPROCKETS

For #60 Roller Chain

Steel Single Sprockets with Split Taper Bushings



PART NO.	BUSHING	BORE RANGE	DIAMETERS		NO. TEETH	TYPE	DIMENSIONS						WT. LESS BUSHING
			OUTSIDE	PITCH			T NOM.	OL	L	P	C	H	
60G10	G	3/8" - 1"	2.76"	2.427"	10	3	.459"	1 3/4"	1"	1 3/32"	9/16"	2"	.6
60H11	H	3/8" - 1 1/2"	2.96"	2.662"	11	3	.459	1 13/16"	1 1/4"	1 5/32"	3/8"	2 1/2"	.7
60H12	H	3/8" - 1 1/2"	3.25"	2.898"	12	3	.459	1 3/4"	1 1/4"	1 3/32"	5/16"	2 1/2"	.8
60H13	H	3/8" - 1 1/2"	3.45"	3.134"	13	3	.459	1 1/2"	1 1/4"	27/32"	1/16"	2 1/2"	.8
60P13	P1	1/2" - 1 3/4"	3.45"	3.134"	13	4	.459	2 3/16"	1 15/16"	1 15/32"	0	3"	1.1
60H14	H	3/8" - 1 1/2"	3.74"	3.371"	14	3	.459	1 1/2"	1 1/4"	27/32"	1/16"	2 1/2"	1.0
60P14	P1	1/2" - 1 3/4"	3.74"	3.371"	14	4	.459	2 3/16"	1 15/16"	1 15/32"	0	3"	1.2
60H15	H	3/8" - 1 1/2"	3.98"	3.607"	15	3	.459	1 1/2"	1 1/4"	27/32"	1/16"	2 1/2"	1.2
60P15	P1	1/2" - 1 3/4"	3.98"	3.607"	15	4	.459	2 3/16"	1 15/16"	1 15/32"	0	3"	1.6
60P16	P1	1/2" - 1 3/4"	4.22"	3.844"	16	4	.459	2 3/16"	1 15/16"	1 15/32"	0	3"	2.0
60P17	P1	1/2" - 1 3/4"	4.46"	4.082"	17	4	.459	2 3/16"	1 15/16"	1 15/32"	0	3"	2.2
60P18	P1	1/2" - 1 3/4"	4.70"	4.319"	18	4	.459	2 3/16"	1 15/16"	1 15/32"	0	3"	2.4
60P19	P1	1/2" - 1 3/4"	4.95"	4.557"	19	4	.459	2 3/16"	1 15/16"	1 15/32"	0	3"	2.5
60P20	P1	1/2" - 1 3/4"	5.19"	4.794"	20	4	.459	2 3/16"	1 15/16"	1 15/32"	0	3"	3.0
60Q20	Q1	3/4" - 2 11/16"	5.19"	4.794"	20	4	.459	2 25/32"	2 1/2"	2 1/32"	0	4 1/8"	3.5
60P21	P1	1/2" - 1 3/4"	5.43"	5.032"	21	4	.459	2 3/16"	1 15/16"	1 15/32"	0	3"	3.0
60Q21	Q1	3/4" - 2 11/16"	5.43"	5.032"	21	4	.459	2 25/32"	2 1/2"	2 1/32"	0	4 1/8"	3.8
60P22	P1	1/2" - 1 3/4"	5.67"	5.270"	22	4	.459	2 3/16"	1 15/16"	1 15/32"	0	3"	3.3
60Q22	Q1	3/4" - 2 11/16"	5.67"	5.270"	22	4	.459	2 25/32"	2 1/2"	2 1/32"	0	4 1/8"	4.1
60P23	P1	1/2" - 1 3/4"	5.91"	5.508"	23	4	.459	2 3/16"	1 15/16"	1 15/32"	0	3"	3.5
60Q23	Q1	3/4" - 2 11/16"	5.91"	5.508"	23	4	.459	2 25/32"	2 1/2"	2 1/32"	0	4 1/8"	4.3
60P24	P1	1/2" - 1 3/4"	6.15"	5.746"	24	4	.459	2 3/16"	1 15/16"	1 15/32"	0	3"	3.9
60Q24	Q1	3/4" - 2 11/16"	6.15"	5.746"	24	4	.459	2 25/32"	2 1/2"	2 1/32"	0	4 1/8"	4.5
60P25	P1	1/2" - 1 3/4"	6.39"	5.984"	25	4	.459	2 3/16"	1 15/16"	1 15/32"	0	3"	4.3
60Q25	Q1	3/4" - 2 11/16"	6.39"	5.984"	25	4	.459	2 25/32"	2 1/2"	2 1/32"	0	4 1/8"	6.0
60P26	P1	1/2" - 1 3/4"	6.63"	6.222"	26	4	.459	2 3/16"	1 15/16"	1 15/32"	0	3"	4.3
60Q26	Q1	3/4" - 2 11/16"	6.63"	6.222"	26	4	.459	2 25/32"	2 1/2"	2 1/32"	0	4 1/8"	6.4
60P27	P1	1/2" - 1 3/4"	6.87"	6.460"	27	4	.459	2 3/16"	1 15/16"	1 15/32"	0	3"	4.6
60Q27	Q1	3/4" - 2 11/16"	6.87"	6.460"	27	4	.459	2 25/32"	2 1/2"	2 1/32"	0	4 1/8"	6.6
60P28	P1	1/2" - 1 3/4"	7.11"	6.699"	28	4	.459	2 3/16"	1 15/16"	1 15/32"	0	3"	5.0
60Q28	Q1	3/4" - 2 11/16"	7.11"	6.699"	28	4	.459	2 25/32"	2 1/2"	2 1/32"	0	4 1/8"	6.9
60Q29	Q1	3/4" - 2 11/16"	7.35"	6.937"	29	4	.459	2 25/32"	2 1/2"	2 1/32"	0	4 1/8"	7.3
60P30	P1	1/2" - 1 3/4"	7.59"	7.175"	30	4	.459	2 3/16"	1 15/16"	1 15/32"	0	3"	5.6
60Q30	Q1	3/4" - 2 11/16"	7.59"	7.175"	30	4	.459	2 25/32"	2 1/2"	2 1/32"	0	4 1/8"	7.7
60Q31	Q1	3/4" - 2 11/16"	7.83"	7.413"	31	4	.459	2 25/32"	2 1/2"	2 1/32"	0	4 1/8"	7.8
60Q32	Q1	3/4" - 2 11/16"	8.07"	7.652"	32	4	.459	2 25/32"	2 1/2"	2 1/32"	0	4 1/8"	8.3
60Q33	Q1	3/4" - 2 11/16"	8.30"	7.890"	33	4	.459	2 25/32"	2 1/2"	2 1/32"	0	4 1/8"	8.7
60Q34	Q1	3/4" - 2 11/16"	8.54"	8.129"	34	4	.459	2 25/32"	2 1/2"	2 1/32"	0	4 1/8"	9.1
60Q35	Q1	3/4" - 2 11/16"	8.78"	8.367"	35	4	.459	2 25/32"	2 1/2"	2 1/32"	0	4 1/8"	9.3
60Q36	Q1	3/4" - 2 11/16"	9.02"	8.605"	36	4	.459	2 25/32"	2 1/2"	2 1/32"	0	4 1/8"	9.9
60Q37	Q1	1/2" - 1 3/4"	9.26"	8.844"	37	4	.459	2 25/32"	2 1/2"	2 1/32"	0	4 1/8"	10.3
60Q38	Q1	3/4" - 2 11/16"	9.50"	9.082"	38	4	.459	2 25/32"	2 1/2"	2 1/32"	0	4 1/8"	10.6
60Q39	Q1	3/4" - 2 11/16"	9.74"	9.321"	39	4	.459	2 25/32"	2 1/2"	2 1/32"	0	4 1/8"	11.1
60Q40	Q1	3/4" - 2 11/16"	9.98"	9.559"	40	4	.459	2 25/32"	2 1/2"	2 1/32"	0	4 1/8"	11.6
60Q41	Q1	3/4" - 2 11/16"	10.22"	9.798"	41	4	.459	2 25/32"	2 1/2"	2 1/32"	0	4 1/8"	11.9
60Q42	Q1	3/4" - 2 11/16"	10.46"	10.036"	42	4	.459	2 25/32"	2 1/2"	2 1/32"	0	4 1/8"	12.6
60Q44	Q1	3/4" - 2 11/16"	10.94"	10.513"	44	4	.459	2 25/32"	2 1/2"	2 1/32"	0	4 1/8"	13.4
60Q45	Q1	3/4" - 2 11/16"	11.18"	10.752"	45	4	.459	2 25/32"	2 1/2"	2 1/32"	0	4 1/8"	13.9
60Q47	Q1	3/4" - 2 11/16"	11.65"	11.229"	47	4	.459	2 25/32"	2 1/2"	2 1/32"	0	4 1/8"	16.3
60Q48	Q1	3/4" - 2 11/16"	11.89"	11.467"	48	4	.459	2 25/32"	2 1/2"	2 1/32"	0	4 1/8"	16.4
60Q50	Q1	3/4" - 2 11/16"	12.37"	11.945"	50	4	.459	2 25/32"	2 1/2"	2 1/32"	0	4 1/8"	16.9
60Q54	Q1	3/4" - 2 11/16"	13.33"	12.899"	54	4	.459	2 25/32"	2 1/2"	2 1/32"	0	4 1/8"	19.6
60Q56	Q1	3/4" - 2 11/16"	13.81"	13.376"	56	4	.459	2 25/32"	2 1/2"	2 1/32"	0	4 1/8"	20.3
60Q60	Q1	3/4" - 2 11/16"	14.73"	14.331"	60	4	.459	2 25/32"	2 1/2"	2 1/32"	0	4 1/8"	22.9
60Q70	Q1	3/4" - 2 11/16"	17.12"	16.717"	70	4	.459	2 25/32"	2 1/2"	2 1/32"	0	4 1/8"	30.9
60R70	R1	1 1/8" - 3 3/4"	17.12"	16.717"	70	4	.459	3 5/32"	2 7/8"	2 13/32"	0	5 3/8"	31.8
60Q72	Q1	3/4" - 2 11/16"	17.63"	17.194"	72	4	.459	2 25/32"	2 1/2"	2 1/32"	0	4 1/8"	31.9
60R72	R1	1 1/8" - 3 3/4"	17.63"	17.194"	72	4	.459	3 5/32"	2 7/8"	2 13/32"	0	5 3/8"	34.1
60Q80	Q1	3/4" - 2 11/16"	19.54"	19.103"	80	4	.459	2 25/32"	2 1/2"	2 1/32"	0	4 1/8"	39.1
60R80	R1	1 1/8" - 3 3/4"	19.54"	19.103"	80	4	.459	3 5/32"	2 7/8"	2 13/32"	0	5 3/8"	41.5
60Q84	Q1	3/4" - 2 11/16"	20.49"	20.058"	84	4	.459	2 25/32"	2 1/2"	2 1/32"	0	4 1/8"	41.6
60R84	R1	1 1/8" - 3 3/4"	20.49"	20.058"	84	4	.459	3 5/32"	2 7/8"	2 13/32"	0	5 3/8"	44.8
60Q96	Q1	3/4" - 2 11/16"	23.36"	22.922"	96	4	.459	2 25/32"	2 1/2"	2 1/32"	0	4 1/8"	54.0
60R96	R1	1 1/8" - 3 3/4"	23.36"	22.922"	96	4	.459	3 5/32"	2 7/8"	2 13/32"	0	5 3/8"	56.0
60Q112	Q1	3/4" - 2 11/16"	27.18"	26.742"	112	4	.459	2 25/32"	2 1/2"	2 1/32"	0	4 1/8"	73.0
60R112	R1	1 1/8" - 3 3/4"	27.18"	26.742"	112	4	.459	3 5/32"	2 7/8"	2 13/32"	0	5 3/8"	74.5

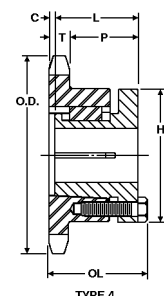
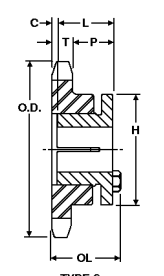

Where two sprockets with the same number of teeth but different bushings are offered, we suggest using the sprocket bushing for heavier service drives.

See pages 28-32 for Bushings

BUSHED SPROCKETS

For #80 Roller Chain

Steel Single Sprockets with Split Taper Bushings

Table with columns: PART NO., BUSH-ING, BORE RANGE, DIAMETERS (OUT-SIDE, PITCH), NO. TEETH, TYPE, DIMENSIONS (T NOM., OL, L, P, C, H), and WT. LESS BUSH-ING. Lists 100 different sprocket models with their specifications.

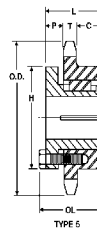
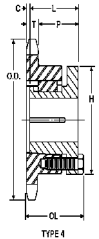
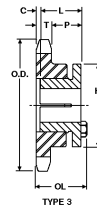

Standard Keyseats Table No. 3

Table with columns: BORE RANGE and KEYSEAT. Lists keyseat specifications for various bore ranges, such as 3/8\"

1 3/8\" Bore Bushings also available with 3/8\" x 3/16\" keyseat.

See pages 28-32 for Bushings

Where two sprockets with the same number of teeth but different bushings are offered, we suggest using the one with the larger bushing for heavier service drives.

BUSHED SPROCKETS

For #100 Roller Chain

Steel Single Sprockets with Split Taper Bushings

PART NO.	BUSHING	BORE RANGE	DIAMETERS		NO. TEETH	TYPE	DIMENSIONS						WT. LESS BUSHING
			OUTSIDE	PITCH			T NOM.	OL	L	P	C	H	
100P11	P1	1/2" - 3/4"	5.01"	4.437"	11	4	.692"	2 3/16"	1 15/16"	1 1/4"	0	3"	3.0
100Q12	Q1	3/4" - 2 11/16"	5.42"	4.830"	12	4	.692"	2 37/32"	2 1/2"	1 7/8"	1/16"	4 1/8"	3.5
100Q13	Q1	3/4" - 2 11/16"	5.82"	5.223"	13	4	.692"	2 27/32"	2 1/2"	1 7/8"	1/16"	4 1/8"	4.3
100Q14	Q1	3/4" - 2 11/16"	6.23"	5.617"	14	4	.692"	2 25/32"	2 1/2"	1 13/16"	0	4 1/8"	5.6
100Q15	Q1	3/4" - 2 11/16"	6.63"	6.012"	15	4	.692"	2 25/32"	2 1/2"	1 13/16"	0	4 1/8"	6.5
100Q16	Q1	3/4" - 2 11/16"	7.03"	6.407"	16	4	.692"	2 25/32"	2 1/2"	1 13/16"	0	4 1/8"	7.4
100Q17	Q1	3/4" - 2 11/16"	7.44"	6.803"	17	4	.692"	2 25/32"	2 1/2"	1 13/16"	0	4 1/8"	8.2
100Q18	Q1	3/4" - 2 11/16"	7.84"	7.198"	18	4	.692"	2 25/32"	2 1/2"	1 13/16"	0	4 1/8"	9.0
100Q19	Q1	3/4" - 2 11/16"	8.24"	7.595"	19	4	.692"	2 25/32"	2 1/2"	1 13/16"	0	4 1/8"	9.9
100Q20	Q1	3/4" - 2 11/16"	8.64"	7.991"	20	4	.692"	2 25/32"	2 1/2"	1 13/16"	0	4 1/8"	10.8
100Q21	Q1	3/4" - 2 11/16"	9.04"	8.387"	21	4	.692"	2 25/32"	2 1/2"	1 13/16"	0	4 1/8"	11.7
100R21	R1	1 1/8" - 3 3/4"	9.04"	8.387"	21	4	.692"	3 5/32"	2 7/8"	2 3/16"	0	5 3/8"	13.3
100Q22	Q1	3/4" - 2 11/16"	9.44"	8.783"	22	4	.692"	2 25/32"	2 1/2"	1 13/16"	0	4 1/8"	12.5
100Q23	Q1	3/4" - 2 11/16"	9.84"	9.180"	23	4	.692"	2 25/32"	2 1/2"	1 13/16"	0	4 1/8"	13.9
100Q24	Q1	3/4" - 2 11/16"	10.25"	9.577"	24	4	.692"	2 25/32"	2 1/2"	1 13/16"	0	4 1/8"	15.5
100R24	R1	1 1/8" - 3 3/4"	10.25"	9.577"	24	4	.692"	3 5/32"	2 7/8"	2 3/16"	0	5 3/8"	16.1
100Q25	Q1	3/4" - 2 11/16"	10.65"	9.973"	25	4	.692"	2 25/32"	2 1/2"	1 13/16"	0	4 1/8"	16.2
100R25	R1	1 1/8" - 3 3/4"	10.65"	9.973"	25	4	.692"	3 5/32"	2 7/8"	2 3/16"	0	5 3/8"	17.0
100Q26	Q1	3/4" - 2 11/16"	11.05"	10.370"	26	4	.692"	2 25/32"	2 1/2"	1 13/16"	0	4 1/8"	17.9
100R26	R1	1 1/8" - 3 3/4"	11.05"	10.370"	26	4	.692"	3 5/32"	2 7/8"	2 3/16"	0	5 3/8"	18.5
100Q27	Q1	3/4" - 2 11/16"	11.45"	10.767"	27	4	.692"	2 25/32"	2 1/2"	1 13/16"	0	4 1/8"	18.2
100R27	R1	1 1/8" - 3 3/4"	11.45"	10.767"	27	4	.692"	3 5/32"	2 7/8"	2 3/16"	0	5 3/8"	19.6
100Q28	Q1	3/4" - 2 11/16"	11.84"	11.164"	28	4	.692"	2 25/32"	2 1/2"	1 13/16"	0	4 1/8"	19.9
100R28	R1	1 1/8" - 3 3/4"	11.84"	11.164"	28	4	.692"	3 5/32"	2 7/8"	2 3/16"	0	5 3/8"	21.0
100Q30	Q1	3/4" - 2 11/16"	12.64"	11.958"	30	4	.692"	2 25/32"	2 1/2"	1 13/16"	0	4 1/8"	22.6
100R30	R1	1 1/8" - 3 3/4"	12.64"	11.958"	30	4	.692"	3 5/32"	2 7/8"	2 3/16"	0	5 3/8"	24.5
100R31	R1	1 1/8" - 3 3/4"	13.04"	12.356"	31	4	.692"	3 5/32"	2 7/8"	2 3/16"	0	5 3/8"	25.8
100Q32	Q1	3/4" - 2 11/16"	13.44"	12.753"	32	4	.692"	2 25/32"	2 1/2"	1 13/16"	0	4 1/8"	25.3
100R32	R1	1 1/8" - 3 3/4"	13.44"	12.753"	32	4	.692"	3 5/32"	2 7/8"	2 3/16"	0	5 3/8"	26.5
100Q35	Q1	3/4" - 2 11/16"	14.64"	13.945"	35	4	.692"	2 25/32"	2 1/2"	1 13/16"	0	4 1/8"	30.2
100R35	R1	1 1/8" - 3 3/4"	14.64"	13.945"	35	4	.692"	3 5/32"	2 7/8"	2 3/16"	0	5 3/8"	29.8
100R36	R1	1 1/8" - 3 3/4"	15.04"	14.342"	36	4	.692"	3 5/32"	2 7/8"	2 3/16"	0	5 3/8"	33.0
100R40	R1	1 1/8" - 3 3/4"	16.63"	15.932"	40	4	.692"	3 5/32"	2 7/8"	2 3/16"	0	5 3/8"	40.9
100R42	R1	1 1/8" - 3 3/4"	17.43"	16.727"	42	4	.692"	3 5/32"	2 7/8"	2 3/16"	0	5 3/8"	44.3
100R45	R1	1 1/8" - 3 3/4"	18.63"	17.920"	45	4	.692"	3 5/32"	2 7/8"	2 3/16"	0	5 3/8"	50.5
100R48	R1	1 1/8" - 3 3/4"	19.82"	19.112"	48	4	.692"	3 5/32"	2 7/8"	2 3/16"	0	5 3/8"	57.5
100R54	R1	1 1/8" - 3 3/4"	22.21"	21.498"	54	5	.692"	3 5/32"	2 7/8"	7/8"	1 5/16"	5 3/8"	69.0
100R60	R1	1 1/8" - 3 3/4"	24.55"	23.884"	60	5	.692"	3 5/32"	2 7/8"	7/8"	1 5/16"	5 3/8"	84.0
100R70	R1	1 1/8" - 3 3/4"	28.53"	27.862"	70	5	.692"	3 5/32"	2 7/8"	7/8"	1 5/16"	5 3/8"	104
100R72	R1	1 1/8" - 3 3/4"	29.33"	28.657"	72	5	.692"	3 5/32"	2 7/8"	7/8"	1 5/16"	5 3/8"	106
100R80	R1	1 1/8" - 3 3/4"	32.52"	31.839"	80	5	.692"	3 5/32"	2 7/8"	7/8"	1 5/16"	5 3/8"	135
100R84	R1	1 1/8" - 3 3/4"	34.11"	33.430"	84	5	.692"	3 5/32"	2 7/8"	7/8"	1 5/16"	5 3/8"	138

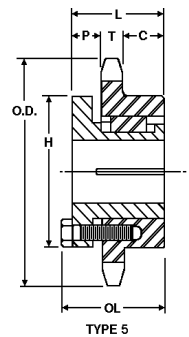
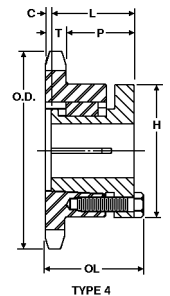

Where two sprockets with the same number of teeth but different bushings are offered, we suggest using the one with the larger bushing for heavier service drives.

See pages 28-32 for Bushings

BUSHED SPROCKETS

For #120 Roller Chain

Steel Single Sprockets with Split Taper Bushings

PART NO.	BUSH-ING	BORE RANGE	DIAMETERS		NO. TEETH	TYPE	DIMENSIONS						WT. LESS BUSHING
			OUT-SIDE	PITCH			T NOM.	OL	L	P	C	H	
120Q11	Q1	3/4" - 2 11/16"	6.01"	5.324"	11	4	.924"	2 25/32"	2 1/2"	1 9/16"	0	4 1/8"	4.8
120Q12	Q1	3/4" - 2 11/16"	6.50"	5.796"	12	4	.924"	2 25/32"	2 1/2"	1 9/16"	0	4 1/8"	6.3
120Q13	Q1	3/4" - 2 11/16"	6.99"	6.268"	13	4	.924"	2 25/32"	2 1/2"	1 9/16"	0	4 1/8"	7.9
120Q14	Q1	3/4" - 2 11/16"	7.47"	6.741"	14	4	.924"	2 25/32"	2 1/2"	1 9/16"	0	4 1/8"	9.1
120Q15	Q1	3/4" - 2 11/16"	7.96"	7.215"	15	4	.924"	2 25/32"	2 1/2"	1 9/16"	0	4 1/8"	10.4
120Q16	Q1	3/4" - 2 11/16"	8.39"	7.689"	16	4	.924"	2 25/32"	2 1/2"	1 9/16"	0	4 1/8"	11.8
120R16	R1	1 1/8" - 3 3/4"	8.39"	7.689"	16	4	.924"	3 5/32"	2 7/8"	1 15/16"	0	5 3/8"	12.3
120Q17	Q1	3/4" - 2 11/16"	8.88"	8.163"	17	4	.924"	2 25/32"	2 1/2"	1 9/16"	0	4 1/8"	13.4
120R17	R1	1 1/8" - 3 3/4"	8.88"	8.163"	17	4	.924"	3 5/32"	2 7/8"	1 15/16"	0	5 3/8"	13.6
120Q18	Q1	3/4" - 2 11/16"	9.41"	8.638"	18	4	.924"	2 25/32"	2 1/2"	1 9/16"	0	4 1/8"	15.6
120R18	R1	1 1/8" - 3 3/4"	9.41"	8.638"	18	4	.924"	3 5/32"	3 5/32"	1 9/16"	0	5 3/8"	15.9
120R19	R1	1 1/8" - 3 3/4"	9.89"	9.113"	19	4	.924"	3 5/32"	3 5/32"	1 9/16"	0	5 3/8"	16.8
120R20	R1	1 1/8" - 3 3/4"	10.37"	9.589"	20	4	.924"	3 5/32"	2 7/8"	1 15/16"	0	5 3/8"	18.8
120R21	R1	1 1/8" - 3 3/4"	10.85"	10.064"	21	4	.924"	3 5/32"	2 7/8"	1 15/16"	0	5 3/8"	21.0
120R22	R1	1 1/8" - 3 3/4"	11.33"	10.540"	22	4	.924"	3 5/32"	2 7/8"	1 15/16"	0	5 3/8"	22.5
120R23	R1	1 1/8" - 3 3/4"	11.81"	11.016"	23	4	.924"	3 5/32"	2 7/8"	1 15/16"	0	5 3/8"	24.8
120R24	R1	1 1/8" - 3 3/4"	12.29"	11.492"	24	4	.924"	3 5/32"	2 7/8"	1 15/16"	0	5 3/8"	26.9
120R25	R1	1 1/8" - 3 3/4"	12.77"	11.968"	25	4	.924"	3 5/32"	2 7/8"	1 15/16"	0	5 3/8"	29.8
120R26	R1	1 1/8" - 3 3/4"	13.25"	12.444"	26	5	.924"	3 5/32"	2 7/8"	7/8"	1 1/16"	5 3/8"	32.9
120R28	R1	1 1/8" - 3 3/4"	14.21"	13.397"	28	5	.924"	3 5/32"	2 7/8"	7/8"	1 1/16"	5 3/8"	38.3
120R30	R1	1 1/8" - 3 3/4"	15.17"	14.350"	30	5	.924"	3 5/32"	2 7/8"	7/8"	1 1/16"	5 3/8"	43.4
120R32	R1	1 1/8" - 3 3/4"	16.13"	15.303"	32	5	.924"	3 5/32"	2 7/8"	7/8"	1 1/16"	5 3/8"	49.4
120R35	R2	1 3/8" - 3 5/8"	17.57"	16.734"	35	6	.924"	5 5/32"	4 7/8"	1 15/16"	2	5 3/8"	68.0
120R36	R2	1 3/8" - 3 5/8"	18.05"	17.211"	36	6	.924"	5 5/32"	4 7/8"	1 15/16"	2	5 3/8"	72.0
120R40	R2	1 3/8" - 3 5/8"	19.96"	19.118"	40	6	.924"	5 5/32"	4 7/8"	1 15/16"	2	5 3/8"	82.0
120S40	S1	1 11/16" - 4 1/4"	19.96"	19.118"	40	5	.924"	4 3/4"	4 3/8"	1 1/16"	2 3/8"	6 3/8"	83.0
120S42	S1	1 11/16" - 4 1/4"	20.92"	20.072"	42	5	.924"	4 3/4"	4 3/8"	1 1/16"	2 3/8"	6 3/8"	90.0
120R45	R2	1 3/8" - 3 5/8"	22.35"	21.503"	45	6	.924"	5 5/32"	4 7/8"	1 15/16"	2	5 3/8"	102
120S45	S1	1 11/16" - 4 1/4"	22.35"	21.503"	45	5	.924"	4 3/4"	4 3/8"	1 1/16"	2 3/8"	6 3/8"	100
120S48	S1	1 11/16" - 4 1/4"	23.79"	22.935"	48	5	.924"	4 3/4"	4 3/8"	1 1/16"	2 3/8"	6 3/8"	111
120S54	S1	1 11/16" - 4 1/4"	26.65"	25.798"	54	5	.924"	4 3/4"	4 3/8"	1 1/16"	2 3/8"	6 3/8"	138
120R60	R2	1 3/8" - 3 5/8"	29.52"	28.661"	60	6	.924"	5 5/32"	4 7/8"	1 15/16"	2	5 3/8"	179
120S60	S1	1 11/16" - 4 1/4"	29.52"	28.661"	60	5	.924"	4 3/4"	4 3/8"	1 1/16"	2 3/8"	6 3/8"	180
120R70	R2	1 3/8" - 3 5/8"	34.30"	33.434"	70	6	.924"	5 5/32"	4 7/8"	1 15/16"	2	5 3/8"	148
120S70	S2	1 7/8" - 4 3/16"	34.30"	33.434"	70	5	.924"	7 1/8"	6 3/4"	2 15/16"	2 7/8"	6 3/8"	167
120R80	R2	1 3/8" - 3 5/8"	39.08"	38.207"	80	6	.924"	5 5/32"	4 7/8"	1 15/16"	2	5 3/8"	291
120S80	S2	1 7/8" - 4 3/16"	39.08"	38.207"	80	6	.924"	7 1/8"	6 3/4"	2 15/16"	2 7/8"	6 3/8"	305

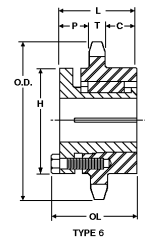
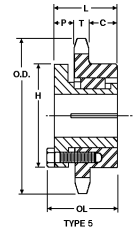
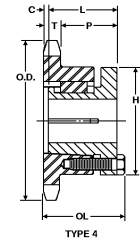
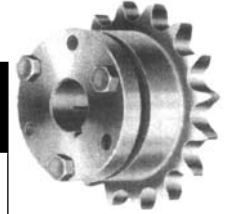

Where two sprockets with the same number of teeth but different bushings are offered, we suggest using the one with the larger bushing for heavier service.

See Section 5 for our TQP or Tsubaki Roller Chain!



See pages 28-32 for Bushings!



BUSHED SPROCKETS

For #140 Roller Chain

Steel Single Sprockets with Split Taper Bushings

PART NO.	BUSHING	BORE RANGE	DIAMETERS		NO. TEETH	TYPE	DIMENSIONS						WT. LESS BUSHING
			OUTSIDE	PITCH			T NOM.	OL	L	P	C	H	
140Q11	Q1	3/4" - 2 11/16"	7.01"	6.212"	11	4	.924"	2 25/32"	2 1/2"	1 9/16"	0	4 1/8"	6.4
140Q12	Q1	3/4" - 2 11/16"	7.58"	6.762"	12	4	.924"	2 25/32"	2 1/2"	1 9/16"	0	4 1/8"	9.0
140R13	R1	1 1/8" - 3 3/4"	8.15"	7.313"	13	4	.924"	3 5/32"	2 7/8"	1 15/16"	0	5 3/8"	11.1
140R14	R1	1 1/8" - 3 3/4"	8.72"	7.864"	14	4	.924"	3 5/32"	2 7/8"	1 15/16"	0	5 3/8"	12.6
140R15	R1	1 1/8" - 3 3/4"	9.28"	8.417"	15	4	.924"	3 5/32"	2 7/8"	1 15/16"	-	5 3/8"	14.7
140R16	R1	1 1/8" - 3 3/4"	9.85"	8.970"	16	4	.924"	3 5/32"	2 7/8"	1 15/16"	0	5 3/8"	16.5
140R17	R1	1 1/8" - 3 3/4"	10.41"	9.524"	17	4	.924"	3 5/32"	2 7/8"	1 15/16"	0	5 3/8"	18.5
140R18	R1	1 1/8" - 3 3/4"	10.97"	10.078"	18	4	.924"	3 5/32"	2 7/8"	1 15/16"	0	5 3/8"	20.5
140R19	R1	1 1/8" - 3 3/4"	11.54"	10.632"	19	4	.924"	3 5/32"	2 7/8"	1 15/16"	0	5 3/8"	23.0
140R20	R1	1 1/8" - 3 3/4"	12.10"	11.187"	20	4	.924"	3 5/32"	2 7/8"	1 15/16"	0	5 3/8"	25.4
140R21	R1	1 1/8" - 3 3/4"	12.66"	11.742"	21	4	.924"	3 5/32"	2 7/8"	1 15/16"	0	5 3/8"	27.8
140R22	R1	1 1/8" - 3 3/4"	13.22"	12.297"	22	5	.924"	3 5/32"	2 7/8"	7/8"	1 1/16"	5 3/8"	32.5
140R23	R1	1 1/8" - 3 3/4"	13.78"	12.852"	23	5	.924"	3 5/32"	2 7/8"	7/8"	1 1/16"	5 3/8"	36.0
140R24	R1	1 1/8" - 3 3/4"	14.34"	13.407"	24	5	.924"	3 5/32"	2 7/8"	7/8"	1 1/16"	5 3/8"	37.6
140R25	R1	1 1/8" - 3 3/4"	14.90"	13.963"	25	5	.924"	3 5/32"	2 7/8"	7/8"	1 1/16"	5 3/8"	40.3
140R26	R1	1 1/8" - 3 3/4"	15.46"	14.513"	26	5	.924"	3 5/32"	2 7/8"	7/8"	1 1/16"	5 3/8"	44.0
140R30	R2	1 3/8" - 3 5/8"	17.70"	16.742"	30	6	.924"	5 5/32"	4 7/8"	7/8"	2"	5 3/8"	68.0
140R35	R2	1 3/8" - 3 5/8"	20.49"	19.523"	35	6	.924"	5 5/32"	4 7/8"	7/8"	2"	5 3/8"	88.0
140R36	R2	1 3/8" - 3 5/8"	21.05"	20.079"	36	6	.924"	5 5/32"	4 7/8"	7/8"	2"	5 3/8"	90.0
140S36	S1	1 11/16" - 4 1/4"	21.05"	20.079"	36	5	.924"	4 3/4"	4 3/8"	1 1/16"	2 3/8"	6 3/8"	89.0
140R40	R2	1 3/8" - 3 5/8"	23.29"	22.305"	40	6	.924"	5 5/32"	4 7/8"	7/8"	2"	5 3/8"	109
140S40	S1	1 11/16" - 4 1/4"	23.29"	22.305"	40	5	.924"	4 3/4"	4 3/8"	1 1/16"	2 3/8"	6 3/8"	107
140S45	S1	1 11/16" - 4 1/4"	26.08"	25.087"	45	5	.924"	4 3/4"	4 3/8"	1 1/16"	2 3/8"	6 3/8"	132
140S48	S2	1 7/8" - 4 3/16"	27.75"	26.757"	48	6	.924"	7 1/2"	6 3/4"	2 15/16"	2 7/8"	6 3/8"	169
140S54	S2	1 7/8" - 4 3/16"	31.10"	30.097"	54	6	.924"	7 1/2"	6 3/4"	2 15/16"	2 7/8"	6 3/8"	208
140S60	S2	1 7/8" - 4 3/16"	34.44"	33.438"	60	6	.924"	7 1/2"	6 3/4"	2 15/16"	2 7/8"	6 3/8"	230
140S70	S2	1 7/8" - 4 3/16"	40.02"	39.006"	70	6	.924"	7 1/2"	6 3/4"	2 15/16"	2 7/8"	6 3/8"	311
140S80	S2	1 7/8" - 4 3/16"	45.59"	44.575"	80	6	.924"	7 1/2"	6 3/4"	2 15/16"	2 7/8"	6 3/8"	242

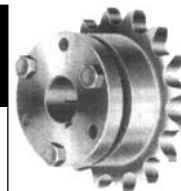

See pages 28-32 for Bushings!

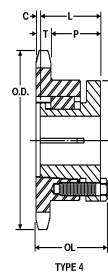
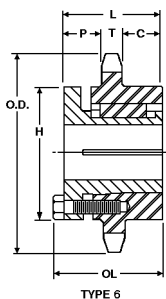
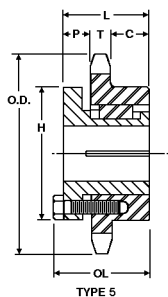

CLUTCHES, BRAKES AND OTHER POWER TRANSMISSION PRODUCTS

A Wide Variety of Specialized Products for Automatic Production

Browning is adding new power transmission products on a continuing basis to broaden the industry's already widest line. As part of this ongoing program, Browning today offers a wide variety of clutches, clutch/brake/coupling combinations, drive tighteners, idlers, hubs, set collars and many other power transmission products. All of these products exemplify Browning's commitment to serving your every requirement in power transmission drives and components.

For example, the advance design Browning/Dynacorp clutch/brake/coupling product line offers up to 37% higher standard torque than competitive models, along with a host of other features-benefits - at no extra cost:

- single electrical connector points
- rugged cast aluminum housings
- stainless steel armature hubs
- 100% product testing
- heavy duty steel tie bolts

TORQ/GARD overload clutches and TORQ/PRO ball detent overall clutches protect your equipment from over-load situations and costly downtime.

Westward has available a full range of Browning Clutches and Brakes. See your nearest branch for availability.

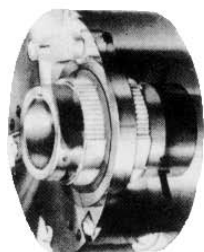

TORQ/GARD
clutch



TORQ/
PRO™ ball
detent over-
load clutch



Doubler
sprocket idler

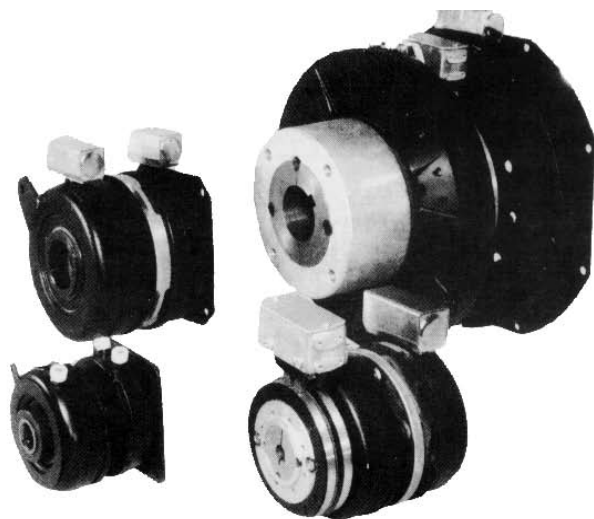

Browning/Dynacorp clutch-brake couplings



Double adjusting
drive tightener



Gearbelt
pulley
idler

BROWNING TORQUE LIMITERS



Browning Torque Limiters are torque control devices which slip under excessive load, but automatically carry the desired load after the excess has been removed. They can easily be adjusted to slip at a desired overload, automatically re-engaging when overload is removed. Overload should be removed promptly since prolonged slippage can be detrimental to the friction disc. No resetting generally is required after the Torque Limiter has slipped. Torque Limiters prevent machine damage, product damage and costly down time caused by shock loads, overloads or machine jams. They should not be used as clutches or to prevent personal injury.

Browning Torque Limiters are primarily for use with sprockets. Sprockets in a wide variety of sizes are available from stock as indicated. Other Stock Type "A" Sprockets can be reworked for Torque Limiters.

Maximum Torque Rating shown can be obtained by using a drive member with center flanges ground to approximately 100 micro-inches surface finish. Rough or rusty center flanges will cause erratic torque values and rapid wear on friction discs. Oil or grease on the center flange or friction discs will reduce the torque values.

Torque Limiter Adjustment

Adjustment of Browning Torque Limiters is fast, simple, and positive. Only an open end wrench and a socket head set screw wrench are needed.

1. Back-off the three cap screws until the points are recessed in the threaded adjusting collar.
2. Tighten the threaded adjusting collar by hand and then tighten the cap screws with an open end wrench until the heads bottom.
3. Try the unit in its application and if further adjustment is necessary, loosen cap screws until points are recessed in the adjusting collar. Torque can also be checked by applying tension to one strand of chain with a spring scale or other means.
4. Tighten or loosen the adjusting collar as needed, then re-tighten the cap screws until the heads bottom.

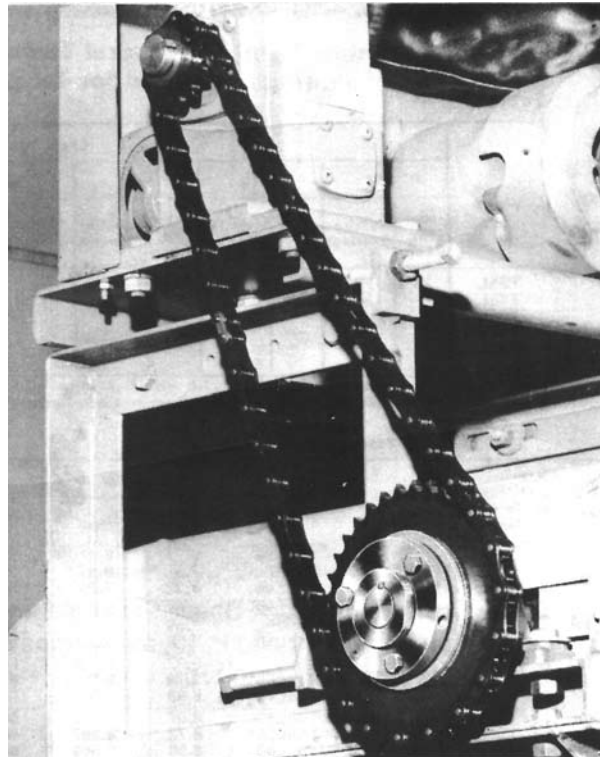

Torque Limiter Selection

When the torque at which the device should slip is determined, simply choose a Torque Limiter from Table No. 2, which has a maximum torque rating as great or greater than the required torque. Check to see if required bore is available, see Table No. 3. It is good practice to select the Torque limiter with a maximum torque rating reasonably greater than the required torque when possible. Torque Limiters should not be used on High Speed Drives.

Example:

To prevent damage to a conveyor system, a device is needed on the head pulley shaft which will slip at 2100 inch pounds of torque. Shaft size is 1 1/4" diameter.

From Table No. 2, note that a T45L Torque Limiter will produce a maximum torque of 2800 inch pounds. It is also available with a 1 1/4" bore. The proper Torque Limiter then, is **T45L x 1 1/4**.

BROWNING TORQUE LIMITERS

Stock Sizes and Parts

TORQUE LIMITERS		REPLACEMENT DISCS 1		REPLACEMENT SPRINGS 2		REPLACEMENT BEARINGS 3	
PART NO.	WT. LBS.	PART NO.	WT. LBS.	PART NO.	WT. LBS.	PART NO.	WT. LBS.
T25L	1.3	25D	.06	25S	.06	25B	.06
T35L	2.9	35D	.06	35S	.06	35B	.06
T45L	5.6	45D	.06	45S	.13	45B	.06
T55L	9.6	55D	.13	55S	.25	55B	.06
T65L	15.8	65D	.13	65S	.31	65B	.06

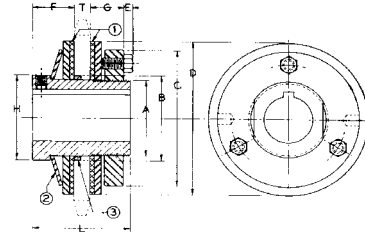

Torque Ratings and Specifications

PART NO.	MAXIMUM TORQUE RATINGS IN INCH-POUNDS		A	B	C	D	E	DIMENSIONS F*		G	H	L	T		
	WITH ONE SPRING	WITH TWO SPRINGS						ONE SPRING	TWO SPRINGS				MIN.	MAX.	
															T25L
T35L	1800	3000	1 3/4	2	3 1/8	3 1/2	3/16	7/8	15/16	13/16	2	2 1/4	2 3/4	3/16	1/2
T45L	2800	4900	2 1/4	2 1/2	4	4 1/2	1/4	1 1/16	1 7/32	15/16	2 1/2	2 3/4	1 1/4	1/4	5/8
T55L	3800	6800	2 3/4	3	4 3/4	5 1/2	1/4	1 1/4	1 3/8	1 1/8	3	3 1/4	1 1/4	3/4	
T65L	4800	8800	3 3/4	4	5 1/2	6 1/2	9/32	1 3/8	1 1/2	1 1/8	4	3 5/8	5/16	1	

Stock Bores

PART NO.	STOCK BORES MARKED "X"															
	1/2"	5/8"	3/4"	7/8"	1"	1 1/8"	1 3/16"	1 1/4"	1 3/8"	1 7/16"	1 1/2"	1 5/8"	1 3/4"	1 15/16"	2"	2 1/2"
T25L	X	X	X	X	-	-	-	-	-	-	-	-	-	-	-	-
T35L	-	X	X	X	X	X	-	-	-	-	-	-	-	-	-	-
T45L	-	-	X	X	X	X	X	X	X	-	-	-	-	-	-	-
T55L	-	-	-	-	X	X	X	X	X	X	X	X	-	-	-	-
T65L	-	-	-	-	-	-	-	-	X	X	X	X	X	X	X	X

Minimum Number Sprocket Teeth and Number of Bearings Required for Torque Limiters

TORQUE LIMITER	CHAIN SIZE											
	35		41		40		50		60		80	
	MIN. NO. TEETH	NO. BEARINGS	MIN. NO. TEETH	NO. BEARINGS	MIN. NO. TEETH	NO. BEARINGS	MIN. NO. TEETH	NO. BEARINGS	MIN. NO. TEETH	NO. BEARINGS	MIN. NO. TEETH	NO. BEARINGS
T25L	25	1	20	1	20	1	-	-	-	-	-	-
T35L	-	-	26	1	26	1	21	2	-	-	-	-
T45L	-	-	-	-	32	1	26	1	22	2	-	-
T55L	-	-	-	-	-	-	32	1	27	2	21	2
T65L	-	-	-	-	-	-	-	-	32	1	24	2



Sprockets for Torque Limiters

PART NO.	DIAMETER		CHAIN SIZE	NO. TEETH	TORQUE LIMITER	FITS WT. LBS.
	OUTSIDE	PITCH				
35T25L25	3.19"	2.992"	35	25	T25L	.1
35T25L30	3.79	3.588	35	30	T25L	.1
35T25L35	4.39	4.183	35	35	T25L	.3
41T25L20	3.45	3.196	41	20	T25L	.1
41T25L30	5.06	4.783	41	30	T25L	.8
41T25L40	6.65	6.373	41	40	T25L	1.7
40T25L20	3.45	3.196	40	20	T25L	.3
40T25L30	5.06	4.783	40	30	T25L	.9
40T25L40	6.65	6.373	40	40	T25L	2.3
40T35L26	4.42	4.148	40	26	T35L	.5
40T35L30	5.06	4.783	40	30	T35L	.8
40T35L40	6.65	6.373	40	40	T35L	1.9
50T35L21	4.52	4.194	50	21	T35L	.7
50T35L30	6.32	5.979	50	30	T35L	1.9
50T35L40	8.32	7.966	50	40	T35L	4.0
50T45L26	5.52	5.185	50	26	T45L	1.0
50T45L30	6.32	5.979	50	30	T45L	1.7
50T45L40	8.32	7.966	50	40	T45L	3.9

Sprockets for Torque Limiters

PART NO.	DIAMETER		CHAIN SIZE	NO. TEETH	TORQUE LIMITER	FITS WT. LBS.
	OUTSIDE	PITCH				
50T55L32	6.72"	6.376"	50	32	T55L	2.0
50T55L35	7.32	6.972	50	35	T55L	2.6
50T55L40	8.32	7.966	50	40	T55L	3.8
60T45L22	5.67	5.270	60	22	T45L	1.7
60T45L30	7.59	7.175	60	30	T45L	4.0
60T45L40	9.98	9.559	60	40	T45L	8.1
60T55L27	6.87	6.460	60	27	T55L	3.1
60T55L35	8.78	8.367	60	35	T55L	6.0
60T55L40	9.98	9.559	60	40	T55L	8.0
60T65L32	8.07	7.652	60	32	T65L	3.8
60T65L35	8.78	8.697	60	35	T65L	5.1
60T65L40	9.98	9.559	60	40	T65L	7.1
80T65L24	8.20	7.661	80	24	T65L	4.8
80T65L35	11.71	11.156	80	35	T65L	13.1
80T65L40	13.31	12.746	80	40	T65L	17.4

SPLIT TAPER & QD WELD-ON HUBS

These weld-on hubs are machined to fit our standard weld-on sprocket on pages 60, 61, 62 & 63. The hubs will adapt all W* and X Series weld-on sprockets to a simple QD & Split Taper Bushing system. QD & Split Taper Bushings are listed on pages 28-32 of this section.

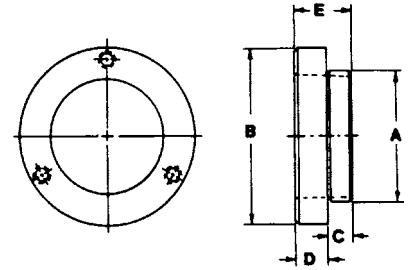

PART NO.	FITS WELD-A-SPKT SERIES	FITS OD BUSHING NO.	A	B	C	D	E	APPROX. WEIGHT
PTP WJA	W*	JA	1 5/8"	2 1/16"	5/16"	7/16"	3/4"	0.41 lbs.
PTP XSH	X	SH	2"	2 11/16"	3/8"	1/2"	7/8"	0.57 lbs.

To Fit Browning Series Bushings

PART NO.	FITS WELD-A-SPKT SERIES	FITS OD BUSHING NO.	A	B	C	D	E	APPROX. WEIGHT
PTP XH	X	H	2"	2 1/2"	5/16"	5/8"	15/16"	0.70 lbs.
PTP YP1	Y	P1	2 3/4"	3"	9/16"	3/4"	1 5/16"	1.40 lbs.

**Will not allow chain clearance on 5012W, 5013W, 6011W or 8009W. Note: Shorter length bolts are furnished with hub. Remember to order Bushing when ordering Weld Hub.*

**Westward Parts has available a full selection of
Kop-Grid Tapered Grid Couplings &
Kop-Flex Elastometric Type Couplings**

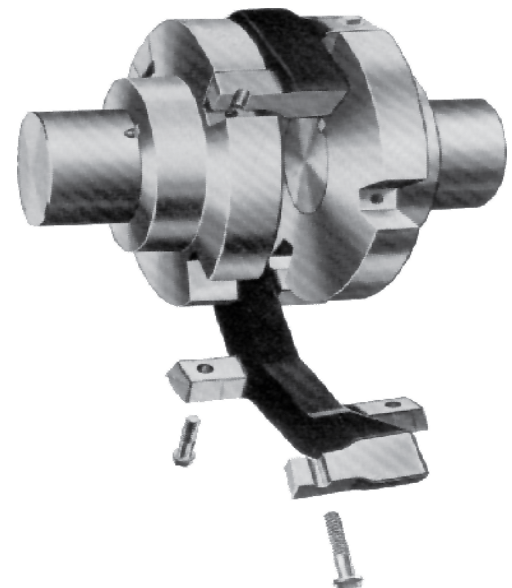
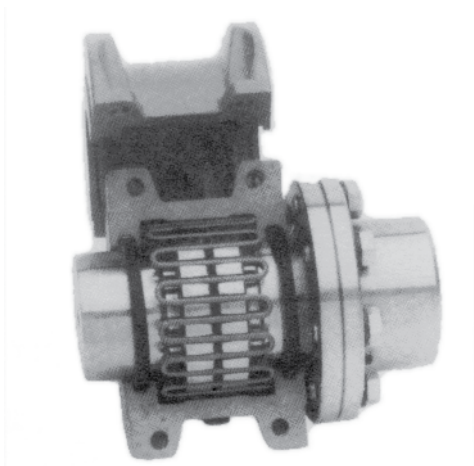

WELD-ON HUBS

For use on Pulleys, Sprockets & Custom Applications

See page 84 for idler style weld-on hubs.

Round Bore

PART NO.	BORE SIZE
PTP 10008V	1/2"
PTP 10009V	9/16"
PTP10010V	5/8"
PTP 10011V	11/16"
PTP 10012V	3/4"
PTP 10013V	13/16"
PTP 10014V	7/8"
PTP 20008W	1/2"
PTP 20009W	9/16"
PTP 20010W	5/8"
PTP 20011W	11/16"
PTP 20012W	3/4"
PTP 20013W	13/16"
PTP 20014W	7/8"
PTP 20015W	15/16"
PTP 20016W	1"
PTP 20017W	1 1/16"

PART NO.	BORE SIZE
PTP 20018W	1 1/8"
PTP 20019W	1 3/16"
PTP 20020W	1 1/4"
PTP 20021W	1 5/16"
PTP 30010X	5/8"
PTP 30011X	11/16"
PTP 30012X	3/4"
PTP 30013X	13/16"
PTP 30014X	7/8"
PTP 30015X	15/16"
PTP 30016X	1"
PTP 30017X	1 1/16"
PTP 30018X	1 1/8"
PTP 30019X	1 3/16"
PTP 30020X	1 1/4"
PTP 30021X	1 5/16"
PTP 30022X	1 3/8"

PART NO.	BORE SIZE
PTP 30023X	1 7/16"
PTP 30024X	1 1/2"
PTP 50016Y	1"
PTP 50017Y	1 1/16"
PTP 50018Y	1 1/8"
PTP 50019Y	1 3/16"
PTP 50020Y	1 1/4"
PTP 50021Y	1 5/16"
PTP 50022Y	1 3/8"
PTP 50023Y	1 7/16"
PTP 20024Y	1 1/2"
PTP 50026Y	1 5/8"
PTP 50027Y	1 11/16"
PTP 50028Y	1 3/4"
PTP 50030Y	1 7/8"
PTP 50031Y	1 15/16"
PTP 50032Y	2"

Spline Bore

PART NO.	BORE SIZE
PTP 21413W	7/8 x 13 SP
PTP 21606W	1 x 6 SP
PTP 21610W	1 - 10 SP
PTP 21615W	1 - 15 SP
PTP 21806W	1 1/8 x 6 SP
PTP 22006W	1 1/4 x 6 SP
PTP 22014W	1 1/4 x 14 SP
PTP 22206W	1 3/8 x 6 SP
PTP 22210W	1 3/8 x 10 SP
PTP 22221W	1 3/8 x 21 SP
PTP 31413X	7/8 x 13 SP
PTP 31606X	1 x 6 SP
PTP 31610X	1 - 10 SP
PTP 31615X	1 - 15 SP
PTP 31806X	1 1/8 x 6 SP
PTP 32006X	1 1/4 x 6 SP
PTP 32014X	1 1/4 x 14 SP
PTP 32206X	1 3/8 x 6 SP
PTP 32210X	1 3/8 x 10 SP
PTP 32221X	1 3/8 x 21 SP
PTP 32410X	1 1/2 x 10 SP
PTP 32806X	1 3/4 x 6 SP

Square Bore

PART NO.	BORE SIZE
PTP 2S010S	5/8"
PTP 2S012W	3/4"
PTP 2S014W	7/8"
PTP 2S016W	1"
PTP 3S010X	5/8"
PTP 3S012X	3/4"
PTP 3S014X	7/8"
PTP 3S015X	15/16"
PTP 3S016X	1"
PTP 3S018X	1 1/8"
PTP 3S019X	1 3/16"
PTP 3S020X	1 1/4"

Hexagon Bore

PART NO.	BORE SIZE
PTP 2H010W	5/8"
PTP 2H012W	3/4"
PTP 2H014W	7/8"
PTP 2H016W	1"
PTP 2H018W	1 1/8"
PTP 2H020W	1 1/4"
PTP 3H010X	5/8"
PTP 3H012X	3/4"
PTP 3H014X	7/8"
PTP 3H016X	1"
PTP 3H018X	1 1/8"

NOTE: A Low Hydrogen Electrode is recommended for welding hub to sprockets or pulleys.

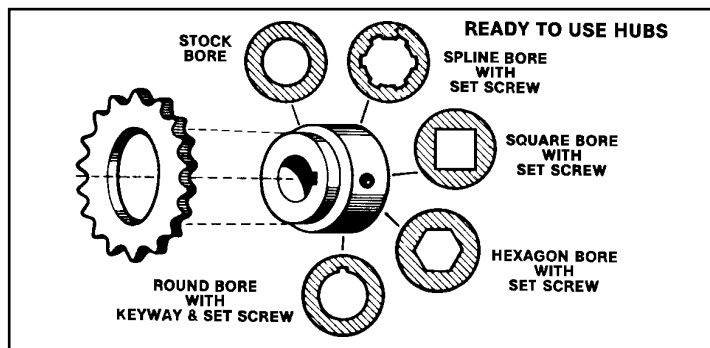

Hub Dimensions

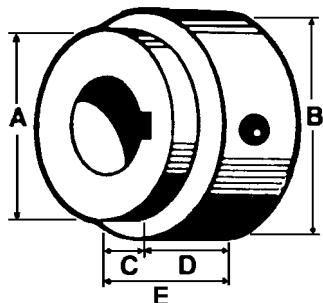

	A	B	C	D	E
V-SERIES HUBS To fit V Type Sprockets	1 1/8"	1 7/16"	7/16"	3/4"	1 3/16"
W-SERIES HUBS To fit W Type Sprockets	1 5/8"	1 13/16"	7/16"	1"	1 7/16"
X-SERIES HUBS To fit X Type Sprockets	2"	2 1/2"	7/16"	1"	1 7/16"
Y-SERIES HUBS To fit Y Type Sprockets	2 3/4"	3 3/4"	11/16"	1 3/16"	1 7/8"

DOUBLE PULLEY HUBS

The Double Pulley Hubs are designed to eliminate any special fixtures for pulley alignment and positioning.

Assembly in 3 Easy Steps

1. Clamp one pulley flush against the shoulder of the Double Pulley Hub and weld both together.
2. Slide the second pulley onto the machined step.
3. Clamp so that it is tight against the first pulley and weld the pulley to the hub on the machined step.



PART NO.	BORE SIZE	KEY WAY	SET SCREWS
PTP DPH0075	3/4"	3/16" x 3/32"	2" x 1/4" -20
PTP DPH0875	7/8"	3/16" x 3/32"	2" x 1/4" -20
PTP DPH1000	1"	1/4" x 1/8"	2" x 5/16" -18
PTP DPH1125	1 1/8"	1/4" x 1/8"	2" x 5/16" -18
PTP DPH1250	1 1/4"	1/4" x 1/8"	2" x 5/16" -18
PTP DPH1250-X	1 1/4"	1/4" x 1/8"	2" x 5/16" -18
PTP DPH1375-X	1 3/8"	5/16" x 5/32"	2" x 3/8" -16
PTP DPH1500-X	1 1/2"	3/8" x 3/16"	3" x 3/8" -16

IDLER WELD HUB

For a quick idler application:
Pick the appropriate Sprocket or Pulley and then pick the corresponding Idler Hub.

Three sizes available to fit W, X & Y series weld-on sprockets and pulleys.

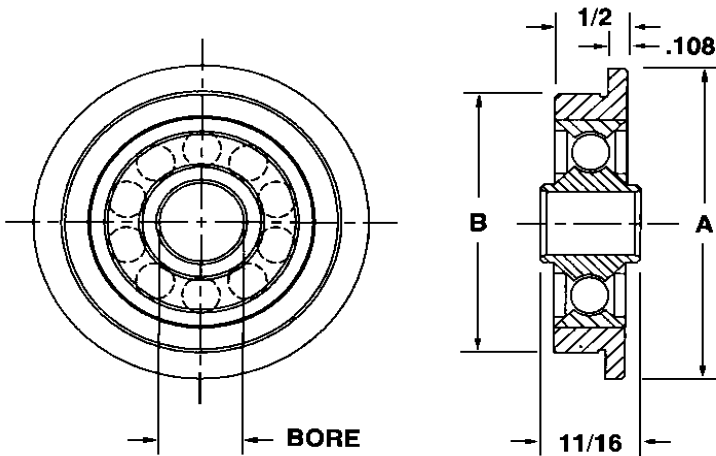

PART NO.	FITS SERIES	DIMENSIONS	
		A	B
PTP 23010W	W	1 13/16	1 5/8
PTP 33010W	X	2 1/4	2

W & X Idler Hubs available in 5/8 I.D. Bores packaged with 1/2 I.D. Reducer Bushing

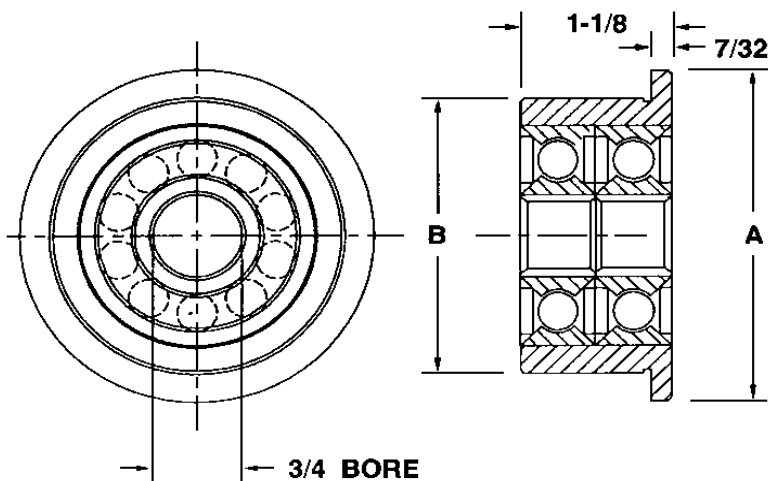

PART NO.	FITS SERIES	DIMENSIONS	
		A	B
PTP 53012Y	Y	3	2 3/4

Y Hub is 3/4" Bore.

Idler Hubs machined to eliminate special fixtures.
Simply clamp idler hub to sprocket or pulley and weld.

SPLIT TAPER & QD WELD-ON HUBS

These weld-on hubs are machined to fit our standard weld-on sprocket on pages 65, 66, 67 & 68. The hubs will adapt all W* and X Series weld-on sprockets to a simple QD & Split Taper Bushing system. QD & Split Taper Bushings are listed on page 32 & 33 of this section.

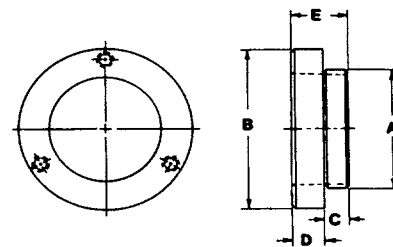

PART NO.	FITS WELD-A-SPRKT SERIES	FITS QD BUSHING NO.	A	B	C	D	E	APPROX. WEIGHT
PTP WJA	W*	JA	1 5/8"	2 1/16"	5/16"	7/16"	3/4"	0.41 lbs.
PTP XSH	X	SH	2"	2 11/16"	3/8"	1/2"	7/8"	0.57 lbs.

To Fit Browning Series Bushings

PART NO.	FITS WELD-A-SPRKT SERIES	FITS QD BUSHING NO.	A	B	C	D	E	APPROX. WEIGHT
PTP XH	X	H	2"	2 1/2"	5/16"	5/8"	15/16"	0.70 lbs.
PTP YP1	Y	P1	2 3/4"	3"	9/16"	3/4"	1 5/16"	1.40 lbs.

*Will not allow chain clearance on 5012W, 5013W, 6011W or 8009W.

Note: Shorter length bolts are furnished with hub.

Remember to order Bushing when ordering Weld Hub.

Weld Hubs to Make Double Sprockets

50 CHAIN DOUBLE HUB	50 CHAIN DOUBLE HUB
A - 2	A - 2
B - 2 1/4 to 2 1/2	B - 2 1/4 to 2 1/2
C - 5/16	C - 7/16
D - 3/8	D - 7/16
E - 1 7/8	E - 2 1/4

Place sprocket on each side of hub & weld to make a double sprocket.

- PTP X5016, 1" Bore
- PTP X5020, 1 1/4" Bore
- PTP X6016, 1" Bore
- PTP X6020, 1 1/4" Bore

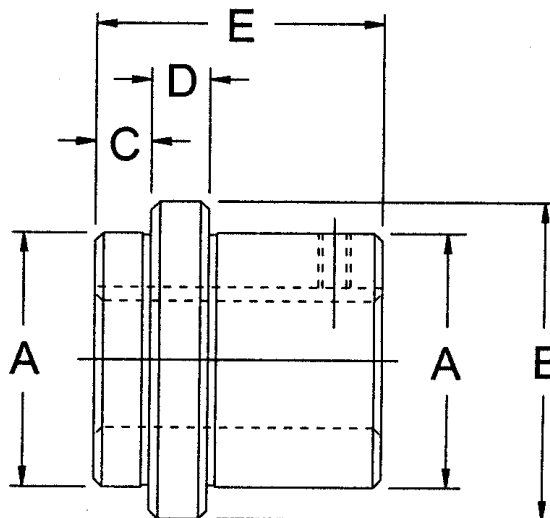

Weld-On Display Assortment

PART NO.
PTP 2448

Display Size 24" x 48"
 Shipping Weight - 130 lbs.
 Includes 61 sprockets, 48 hubs, complete with display board and hardware



Contains the following:

HUBS	SPROCKETS		
	NO. 40-1 CHAIN	NO. 50-1 CHAIN	NO. 60-1 CHAIN
2 - 10008V			
2 - 10010V	2 - 4012V	1 - 5010V	2 - 6011W
2 - 10012V	1 - 4013V	1 - 5011V	2 - 6012W
2 - 10014V	1 - 4014V	2 - 5012W	1 - 6013W
2 - 20008W	2 - 4015V	2 - 5013W	1 - 6014W
2 - 20010W	2 - 4016W	2 - 5014W	2 - 6015X
2 - 20012W	2 - 4017W	2 - 5015W	1 - 6016X
2 - 20014W	2 - 4018W	2 - 5016W	1 - 6017X
2 - 20015W	1 - 4019W	1 - 5017X	2 - 6018X
2 - 20016W	1 - 4020X	2 - 5018X	1 - 6020X
2 - 20018W	1 - 4022X	1 - 5019X	1 - 6022X
2 - 20019W	1 - 4024X	1 - 5020X	1 - 6024X
2 - 20020W	1 - 4025X	1 - 5022X	1 - 6030X
2 - 30010X	1 - 4028X	1 - 5024X	
2 - 30012X	1 - 4030X	1 - 5026X	NO. 80-1 CHAIN
2 - 30014X		1 - 5028X	2 - 8011W
4 - 30016X		1 - 5030X	2 - 8014X
2 - 30018X			2 - 8016X
2 - 30019X			2 - 8018X
2 - 30020X			
2 - 30023X			
2 - 30024X			

WELD-ON SPROCKET, HUB AND PULLEY DISPLAY

DRIVECENTRE

PTP 12003000 Drivecentre Includes:

The Westward Display Center is a dealer merchandiser that makes selling easy. The 48" x 60" floor fixture contains an inventory of the most popular sizes including all items on this page.

PART NO.	DESCRIPTION
PTP 12003000	Complete Display with Board

*Stand is free when Full Product Package is purchased.

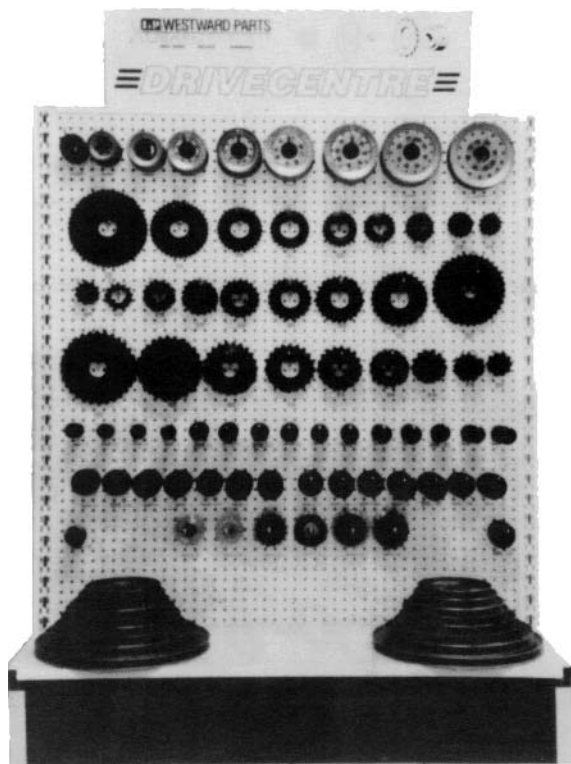

#40 SPROCKET		#60 SPROCKET		V HUB (1 1/8")	
QTY	PART NO.	QTY	PART NO.	QTY	PART NO.
3	4012V	2	6009V	3	10008V
3	4013V	2	6010V	3	10010V
3	4014V	3	6011W	3	10012V
3	4015V	3	6012W	3	10014V
3	4016W	3	6013W	W HUB (1 5/8")	
3	4017W	3	6014W	QTY	PART NO.
3	4018W	3	6015X	2	20008W
3	4019W	2	6016X	1	20009W
3	4020X	2	6017X	4	20010W
2	4021X	2	6018X	1	20011W
2	4022X	2	6019X	4	20012W
2	4024X	2	6020X	1	20013W
2	4026X	2	6021X	4	20014W
2	4028X	2	6022X	4	20014W
2	4030X	2	6024X	2	20015W
2	4036X	2	6026X	10	20016W
1	4040X	1	6028X	1	20017W
1	4045X	1	6030X	4	20018W
1	4048X	IDLER SPROCKETS		1	20019W
#50 SPROCKET		QTY	PART NO.	4	20020W
QTY	PART NO.	1	ID40A18-1/2	1	21806W
2	5010V	2	ID40A18-5/8	1	22206W
2	5011V	2	ID50A17-1/2	X HUB (2")	
4	5012W	2	ID50A17-5/8	QTY	PART NO.
3	5013W	2	ID60A15-1/2	2	30010X
3	5014W	2	ID60A15-5/8	1	30011X
3	5015W	IDLER SPROCKETS		3	30012X
3	5016W	QTY	PART NO.	1	30013X
3	5017X	3	21010025	3	30014X
3	5018X	3	21010030	2	30015X
2	5019X	3	21020035	8	30016X
2	5020X	3	21020040	2	30017X
2	5021X	3	21020045	3	30018X
2	5022X	3	21020050	2	30019X
2	5024X	3	21020055	4	30020X
2	5026X	3	21020060	1	30021X
2	5028X	3	21020065	3	30022X
2	5030X	2	21020070	2	30023X
2	5032X	2	21020080	3	30024X
2	5036X	2	21020090	1	31806X
		2	21020100	1	32206X
		2	21020110		
		2	21020120		
		2	21020140		
		2	21020160		

WELD-ON SPROCKETS

35 Chain

Fits V Series Hub (1 1/8")

PART NO.	TEETH	O.D.
PTP 3515V	15	1.99"
PTP 3516V	16	2.11"
PTP 3517V	17	2.23"
PTP 3518V	18	2.35"
PTP 3519V	19	2.47"
PTP 3520V	20	2.59"
PTP 3521V	21	2.71"

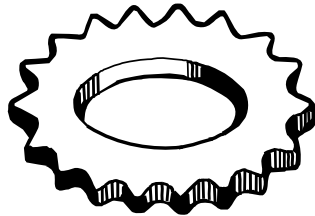

Fits W Series Hub (1 5/8")

PART NO.	TEETH	O.D.
PTP 3522W	22	2.83"
PTP 3523W	23	2.95"
PTP 3524W	24	3.07"
PTP 3525W	25	3.19"
PTP 3526W	26	3.31"
PTP 3527W	27	3.43"
PTP 3528W	28	3.55"
PTP 3529W	29	3.67"
PTP 3530W	30	3.79"
PTP 3531W	31	3.91"
PTP 3532W	32	4.03"
PTP 3533W	33	4.15"
PTP 3535W	35	4.39"
PTP 3534W	34	4.27"
PTP 3536W	36	4.51"
PTP 3537W	37	4.63"
PTP 3538W	38	4.75"
PTP 3539W	39	4.87"
PTP 3540W	40	4.99"

Fits W Series Hub (1 5/8")

PART NO.	TEETH	O.D.
PTP 3541W	41	5.11"
PTP 3542W	42	5.23"
PTP 3543W	43	5.35"
PTP 3544W	44	5.47"
PTP 3545W	45	5.59"
PTP 3546W	46	5.71"
PTP 3548W	48	5.95"
PTP 3550W	50	6.19"
PTP 3552W	52	6.42"
PTP 3554W	54	6.66"
PTP 3556W	56	6.78"
PTP 3558W	58	7.02"
PTP 3560W	60	7.38"
PTP 3565W	65	7.98"
PTP 3570W	70	8.58"
PTP 3580W	80	9.77"
PTP 3590W	90	10.85"
PTP 3596W	96	11.68"

40 Chain

Fits V Series Hub (1 1/8")

PART NO.	TEETH	O.D.
PTP 4011V	11	2.02"
PTP 4012V	12	2.17"
PTP 4013V	13	2.30"
PTP 4014V	14	2.49"
PTP 4015V	15	2.65"

Fits W Series Hub (1 5/8")

PART NO.	TEETH	O.D.
PTP 4016W	16	2.80"
PTP 4017W	17	2.96"
PTP 4018W	18	3.14"
PTP 4019W	19	3.30"

Fits X Series Hub (2")

PART NO.	TEETH	O.D.
PTP 4020X	20	3.45"
PTP 4021X	21	3.62"
PTP 4022X	22	3.75"
PTP 4023X	23	3.94"
PTP 4024X	24	4.10"
PTP 4025X	25	4.26"
PTP 4026X	26	4.42"
PTP 4027X	27	4.58"
PTP 4028X	28	4.74"
PTP 4029X	29	4.90"
PTP 4030X	30	5.06"
PTP 4031X	31	5.22"
PTP 4032X	32	5.38"
PTP 4033X	33	5.54"
PTP 4034X	34	5.70"
PTP 4035X	35	5.86"
PTP 4036X	36	6.02"
PTP 4037X	37	6.18"
PTP 4038X	38	6.33"
PTP 4039X	39	6.49"
PTP 4040X	40	6.65"
PTP 4041X	41	6.81"
PTP 4042X	42	6.97"
PTP 4043X	43	7.13"

Fits X Series Hub (2")

PART NO.	TEETH	O.D.
PTP 4044X	44	7.29"
PTP 4045X	45	7.45"
PTP 4046X	46	7.61"
PTP 4047X	47	7.77"
PTP 4048X	48	7.93"
PTP 4049X	49	8.09"
PTP 4050X	50	8.25"
PTP 4051X	51	8.41"
PTP 4052X	52	8.57"
PTP 4053X	53	8.73"
PTP 4054X	54	8.89"
PTP 4055X	55	9.04"
PTP 4056X	56	9.20"
PTP 4058X	58	9.52"
PTP 4060X	60	9.84"
PTP 4065X	65	10.64"
PTP 4070X	70	11.43"
PTP 4072X	72	11.75"
PTP 4076X	76	12.39"
PTP 4080X	80	13.03"
PTP 4084X	84	13.66"
PTP 4090X	90	14.46"
PTP 4096X	96	15.57"

WELD-ON SPROCKETS

50 Chain

Fits V Series Hub (1 1/8")

PART NO.	TEETH	O.D.
PTP 5009V	9	2.10"
PTP 5010V	10	2.30"
PTP 5011V	11	2.50"

Fits X Series Hub (2")

PART NO.	TEETH	O.D.
PTP 5017X	17	3.72"
PTP 5018X	18	3.92"
PTP 5019X	19	4.12"
PTP 5020X	20	4.32"
PTP 5021X	21	4.52"
PTP 5022X	22	4.70"
PTP 5023X	23	4.92"
PTP 5024X	24	5.12"
PTP 5025X	25	5.32"
PTP 5026X	26	5.52"
PTP 5027X	27	5.72"
PTP 5028X	28	5.92"
PTP 5029X	29	6.12"
PTP 5030X	30	6.32"
PTP 5031X	31	6.52"
PTP 5032X	32	6.72"
PTP 5033X	33	6.92"
PTP 5034X	34	7.12"
PTP 5035X	35	7.32"
PTP 5036X	36	7.52"
PTP 5037X	37	7.72"
PTP 5038X	38	7.92"
PTP 5039X	39	8.12"
PTP 5040X	40	8.32"
PTP 5041X	41	8.52"

Fits X Series Hub (2")

PART NO.	TEETH	O.D.
PTP 5042X	42	8.72"
PTP 5043X	433	8.91"
PTP 5044X	44	9.11"
PTP 5045X	45	9.31"
PTP 5046X	46	9.51"
PTP 5047X	47	9.71"
PTP 5048X	48	9.91"
PTP 5049X	49	10.11"
PTP 5050X	50	10.31"
PTP 5051X	51	10.51"
PTP 5052X	52	10.71"
PTP 5053X	53	10.91"
PTP 5054X	54	11.11"
PTP 055X	55	11.31"
PTP 056X	56	11.50"
PTP 5058X	58	11.90"
PTP 5060X	60	12.30"
PTP 5065X	65	13.30"
PTP 5070X	70	14.29"
PTP 5072X	72	14.69"
PTP 5076X	76	15.49"
PTP 5080X	80	16.28"
PTP 5090X	90	18.28"
PTP 5096X	96	19.47"

Fits W Series Hub (1 5/8")

PART NO.	TEETH	O.D.
PTP 5012W	12	2.70"
PTP 5013W	13	2.91"
PTP 5014W	14	3.11"
PTP 5015W	15	3.32"
PTP 5016W	16	3.52"

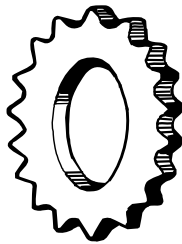

60 Chain

Fits V Series Hub (1 1/8")

PART NO.	TEETH	O.D.
PTP 6008V	8	2.28"
PTP 6009V	9	2.51"
PTP 6010V	10	2.76"

Fits X Series Hub (2")

PART NO.	TEETH	O.D.
PTP 6015X	15	3.98"
PTP 6016X	16	4.22"
PTP 6017X	17	4.46"
PTP 6018X	18	4.70"
PTP 6019X	19	4.95"
PTP 6020X	20	5.19"
PTP 6021X	21	5.43"
PTP 6022X	22	5.67"
PTP 6023X	23	5.91"
PTP 6024X	24	6.15"
PTP 6025X	25	6.39"
PTP 6026X	26	6.53"
PTP 6027X	27	6.87"
PTP 6028X	28	7.11"
PTP 6029X	29	7.35"
PTP 6030X	30	7.59"
PTP 6031X	31	7.83"
PTP 6032X	32	8.07"
PTP 6033X	33	8.30"
PTP 6034X	34	8.54"
PTP 035X	35	8.78"
PTP 6036X	36	9.02"
PTP 6037X	37	9.26"
PTP 6038X	38	9.50"
PTP 6039X	39	9.74"
PTP 6040X	40	9.98"

Fits X Series Hub (2")

PART NO.	TEETH	O.D.
PTP 6041X	41	10.22"
PTP 6042X	42	10.46"
PTP 6043X	43	10.70"
PTP 6044X	44	10.94"
PTP 6045X	45	11.18"
PTP 6046X	46	11.42"
PTP 6047X	47	11.65"
PTP 6048X	48	11.89"
PTP 6049X	49	12.13"
PTP 6050X	50	12.37"
PTP 6051X	51	12.61"
PTP 6052X	52	12.85"
PTP 6053X	53	13.09"
PTP 6054X	54	13.33"
PTP 6055X	55	13.57"
PTP 6056X	56	13.81"
PTP 6058X	58	14.28"
PTP 6060X	60	14.76"
PTP 6065X	65	15.93"
PTP 6070X	70	17.15"
PTP 6072X	72	17.63"
PTP 6076X	76	18.55"
PTP 6080X	80	19.54"
PTP 6084X	84	20.49"
PTP 6090X	90	21.93"
PTP 6096X	96	23.36"

Fits W Series Hub (1 5/8")

PART NO.	TEETH	O.D.
PTP 6011W	11	3.00"
PTP 6012W	12	3.25"
PTP 6013W	13	3.45"
PTP 6014W	14	3.74"

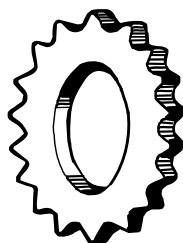

WELD-ON SPROCKETS

80 Chain

Fits W Series Hub (1 5/8")

PART NO.	TEETH	O.D.
PTP 8009W	9	3.35"
PTP 8010W	10	3.68"
PTP 8011W	11	4.01"

Fits X Series Hub (2")

PART NO.	TEETH	O.D.
PTP 8012X	12	4.33"
PTP 8013X	13	4.66"
PTP 8014X	14	4.98"
PTP 8015X	15	5.30"

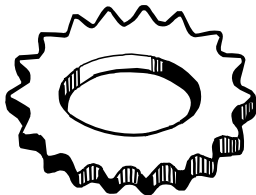

Fits X Series Hub (2")

PART NO.	TEETH	O.D.
PTP 8016X	16	5.63"
PTP 8017X	17	5.95"
PTP 8018X	18	6.27"
PTP 8019X	19	6.59"
PTP 8020X	20	6.91"
PTP 8021X	21	7.24"
PTP 8022X	22	7.56"
PTP 8023X	23	7.88"
PTP 8024X	24	8.20"
PTP 8025X	25	8.52"
PTP 8026X	26	8.84"
PTP 8027X	27	9.16"
PTP 8028X	28	9.48"
PTP 8029X	29	9.80"
PTP 8030X	30	10.11"
PTP 8031X	31	10.43"
PTP 8032X	32	10.75"
PTP 8033X	33	11.07"
PTP 8034X	34	11.39"
PTP 8035X	35	11.71"
PTP 8036X	36	11.98"
PTP 8037X	37	12.35"
PTP 8038X	38	12.67"

Fits X Series Hub (2")

PART NO.	TEETH	O.D.
PTP 8039X	39	12.99"
PTP 8040X	40	13.31"
PTP 8041X	41	13.63"
PTP 8042X	42	13.94"
PTP 8043X	43	14.26"
PTP 8044X	44	14.58"
PTP 8045X	45	14.90"
PTP 8046X	46	15.22"
PTP 8047X	47	15.54"
PTP 8048X	48	15.86"
PTP 8049X	49	16.18"
PTP 8050X	50	16.50"
PTP 8051X	51	16.81"
PTP 8052X	52	17.13"
PTP 8053X	53	17.45"
PTP 8054X	54	17.77"
PTP 8055X	55	18.09"
PTP 8056X	56	18.41"
PTP 8058X	58	19.04"
PTP 8060X	60	19.64"
PTP 8070X	70	22.83"
PTP 8080X	80	26.01"

100 Chain

Fits X Series Hub (2")

PART NO.	TEETH	O.D.
PTP 10010X	10	4.60"
PTP 10011X	11	5.01"
PTP 10012X	12	5.42"
PTP 10013X	13	5.82"

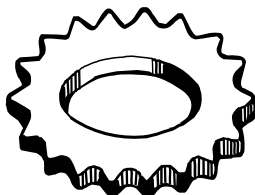

Fits Y Series Hub (2 3/4")

PART NO.	TEETH	O.D.
PTP 10014Y	14	6.23"
PTP 10015Y	15	6.63"
PTP 10016Y	16	7.03"
PTP 10017Y	17	7.44"
PTP 10018Y	18	7.84"
PTP 10019Y	19	8.24"
PTP 10020Y	20	8.64"
PTP 10021Y	21	9.04"
PTP 10022Y	22	9.44"
PTP 10023Y	23	9.84"

Fits Y Series Hub (2 3/4")

PART NO.	TEETH	O.D.
PTP 10024Y	24	10.25"
PTP 10025Y	25	10.65"
PTP 10026Y	26	11.05"
PTP 10028Y	28	11.84"
PTP 10030Y	30	12.64"
PTP 10032Y	32	13.44"
PTP 10035Y	35	14.64"
PTP 10036Y	36	16.04"
PTP 10040Y	40	16.63"

WELD-ON SPROCKETS

For A550 & CA550 Chain* & 55 Detachable

PART NO.	NO. OF TEETH	SPROCKET O.D.	USE HUB SERIES
PTP 55006W	6	3 3/4"	W
PTP 55007X	7	4 1/4"	X
PTP 55008X	8	4 3/4"	X
PTP 55009X	9	5 1/4"	X
PTP 55010X	10	5 3/4"	X
PTP 55011X	11	6 1/4"	X
PTP 55012X	12	6 3/4"	X
PTP 55013X	13	7 1/4"	X
PTP 55014X	14	7 3/4"	X
PTP 55015X	15	8 1/4"	X

A550 & CA550 have a pitch size of 1.630"

For A620 & CA620 Chain* & 62 Detachable

PART NO.	NO. OF TEETH	SPROCKET O.D.	USE HUB SERIES
PTP 62006W	6	3 7/8"	W
PTP 62007X	7	4 3/8"	W
PTP 62008X	8	4 7/8"	X
PTP 62009X	9	5 3/8"	X
PTP 62010X	10	5 7/8"	X
PTP 62011X	11	6 1/2"	X
PTP 62012X	12	7"	X

A620 & CA620 have a pitch size of 1.654"

*Sprockets will also fit Steel Detachable Chain

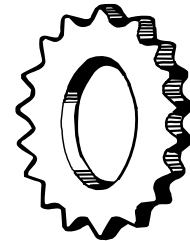

CAST & STEEL SPROCKETS

For #67 Detachable Chain

#67 Chain = 2.313" pitch length

PART NO.	CHAIN SIZE	NO. OF TEETH	PITCH DIA.	MATERIAL
PTP 67B6C	67	6	4.62"	cast
PTP 67B7C	67	7	5.31"	cast
PTP 67B8C	67	8	6.05"	cast
PTP 67B6S	67	6	4.62"	steel
PTP 67B7S	67	7	5.31"	steel
PTP 67B8S	67	8	6.05"	steel

Note: All sprockets have a rough stock bore.

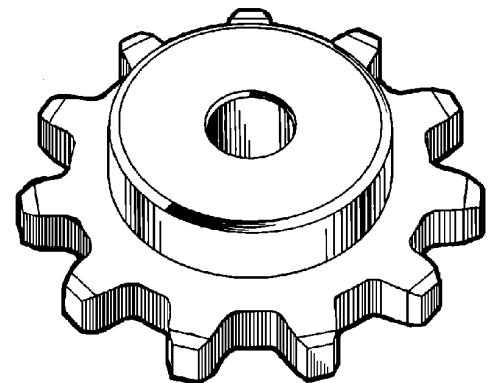

CHAIN PULLERS

This unique tool was designed to make roller chain installation quick and easy. In fact, it's almost like having a third hand.



PART NO.	CHAIN SIZE	JAW SPREAD	WT. (LBS.)
PTP 35	No. 35 to 60	2"	.4
PTP 80	No. 80 to 240	5"	2.0

To use the Browning Chain Puller: (1) hook the two jaws into each end of the chain; (2) turn the screw until the two ends almost meet; (3) insert the connecting link and fasten.

PTP80

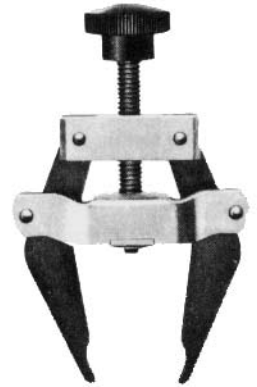
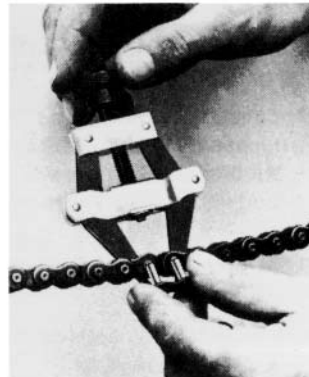

PTP35

ECONOMICAL ROLLER CHAIN HOLDER



PART NO.
PTP CH-1

The Roller Chain Holder for ANSI chain sizes 35 through 60.

Now a one man job for fast, easy replacement of broken links. You can now hold your chain together in position and leave your hands free for working, not chain holding.

This compact tool will save time and effort by allowing you to repair roller chain without removing it from your machine.

PLATE STEEL IDLER SPROCKETS

Plate Steel Sprockets with Precision Ball Bearings

PART NO.	FOR CHAIN NO.	NO. OF TEETH	OUTSIDE DIAMETER	BORE
PTP 20401708	40-IR	17	2.96"	1/2"
PTP 20401710	40-IR	17	2.96"	5/8"
PTP ID40A18-1/2	40-IR	18	3.14"	1/2"
PTP ID40A18-5/8	40-IR	18	3.14"	5/8"
PTP 20501508	50-IR	15	3.32"	1/2"
PTP 20501510	50-IR	15	3.32"	5/8"
PTP ID50A17-1/2	50-IR	17	3.40"	1/2"
PTP ID50A17-5/8	50-IR	17	3.40"	5/8"
PTP 20601308	60-IR	13	3.45"	1/2"
PTP 20601310	60-IR	13	3.45"	5/8"
PTP ID60A15-1/2	60-IR	15	3.98"	1/2"
PTP ID60A15-5/8	60-IR	15	3.98"	5/8"
PTP ID80A12-3/4	80-IR	12	4.33"	3/4"
PTP ID100A11-1	100-IR	11	5.00"	1"
PTP 55008-5/8	A550	8	4.75"	5/8"
PTP ID2040A11-1/2	2040	22	3.78"	1/2"
PTP ID2040A11-5/8	2040	22	3.78"	5/8"
PTP ID2050A09-1/2	2050	18	3.92"	1/2"
PTP ID2050A09-5/8	2050	18	3.92"	5/8"
PTP ID2060A07-1/2	2060	14	3.74"	1/2"
PTP ID2060A07-5/8	2060	14	3.74"	5/8"

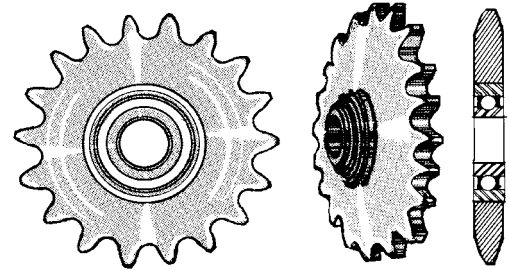

- Yellow plated finish
- Made of plate steel complete with high precision bearings, held in place with snap rings.
- For the tough applications where quality is high and price is right.

*Press steel

SPROCKET IDLERS

Single Pitch Sprocket Idlers

PART NO.	CHAIN SIZE	PITCH SIZE	NO. OF TEETH	BORE SIZE "A"	O.D. "C"	HUB WIDTH "F"
PTP AG2318A	40 or 41	1/2"	18	1/2"	3 1/16"	3/4"
PTP AG2416A	50	5/8"	17	1/2"	3 5/8"	.927"
PTP AG2416	50	5/8"	17	5/8"	3 5/8"	.927"
PTP AG2417A	60	3/4"	15	1/2"	3 29/32"	.927"
PTP AG2417	60	3/4"	15	5/8"	3 29/32"	.927"

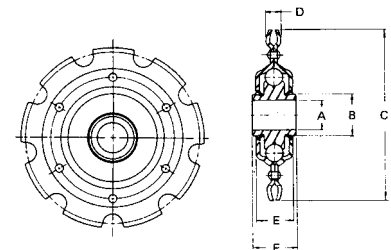

Extended Pitch Sprocket Idlers

PART NO.	CHAIN SIZE	PITCH SIZE	NO. OF TEETH	BORE SIZE "A"	O.D. "C"	HUB WIDTH "F"
PTP AG2419C	2040	1"	11	1/2"	3 25/32"	.927"
PTP AG2419	2040	1"	11	5/8"	3 25/32"	.927"
PTP AG2416C	2050	1 1/4"	9	1/2"	3 27/32"	.927"
PTP AG2416B	2050	1 1/4"	9	5/8"	3 27/32"	.927"
PTP AG2417C	2060	1 1/2"	7	1/2"	3 3/4"	.927"
PTP AG2417B	2060	1 1/2"	7	5/8"	3 3/4"	.927"

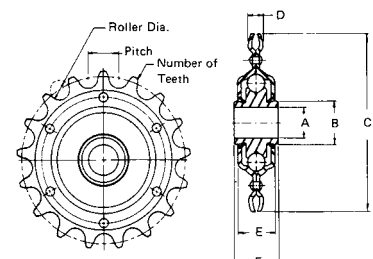

ROLLER CHAIN TOOL

Removes connecting pin completely.
No need for hammer and punch to finish the job!

Patented clamping cylinder assures proper alignment for punching and riveting.

Serves as portable vise, aligning the chain securely in the tool's jaws and positioning the punch squarely in line with the connecting pin. This clamping sleeve eliminates sidebar distortion. Then, with a few turns of the punch screw

with a wrench, the user can apply gradual pressure and force the pin all the way out.

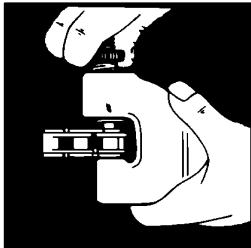

PART NO.	DESCRIPTION
CHA B5035	#35 to #50 Tool
CHA B5038	Pin for B5035
CHA A8050	#50 to #80 Tool
CHA A8053	Pin for A8050

Model A-8050

Fits #50, #60 and #80 Series Roller Chain including 60H and 80H.

Model B-5035

For repairing #35, #40, #41 and #50 series roller chain. Ideal tool for the midsized chain found on ag equipment. Same patented features and clear, heavy duty clamshell packaging as Model A-8050.

TRADITIONAL CHAIN TOOL

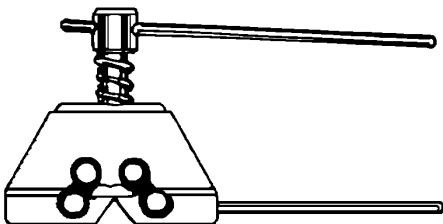

PART NO.	DESCRIPTION	CHAIN SIZE
CHA 165113	PE-113 chain breaker	25 thru 60
CHA 165114	PE-113 replacement tip	
CHA 165135	PE-135 chain breaker	60 thru 100
CHA 165136	PE-135 replacement tip	

DETACHABLE STEEL CHAIN BREAKERS

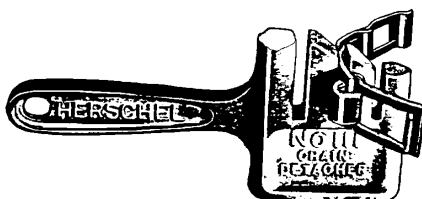

PART NO.	DESCRIPTION
CHA 111	Breaker for detachable chain

Display Board is free with Product Package order.

AGRICULTURAL TYPE IDLER SPROCKETS

- Top quality at low, low cost.
- Durable, long-lasting design.
- Two stamped, hardened halves hold a pre-lubricated, sealed bearing single pitch or extended pitch idlers.
- 1/2" or 5/8" bores - mount with standard bolts.
- Virtually maintenance-free operation.
- Zinc-plated finish.



Ball Bearing Type
Precision Sealed Bearing

Single Pitch Idlers

PART NO.	PITCH	ROLLER DIA.	NO. OF TEETH	A	B	C	D	CHAIN NUMBER
PTP 55840	1/2	.312	18	.500	3/4	3 1/16	15/64	40-41
PTP 55841	1/2	.312	18	.625	3/4	3 1/16	15/64	40-41
PTP 55842	5/8	.400	17	.500	3/4	3 5/8	5/16	50
PTP 55843	5/8	.400	17	.625	3/4	3 5/8	5/16	50
PTP 55844	3/4	15/32	15	.500	3/4	3 29/32	7/16	60
PTP 55845	3/4	15/32	15	.625	3/4	3 29/32	7/16	60

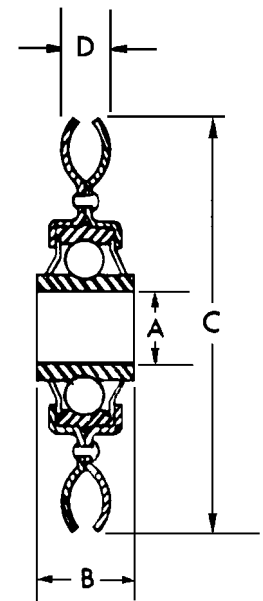

Extended Pitch Idlers

PART NO.	PITCH	ROLLER DIA.	NO. OF TEETH	A	B	C	D	CHAIN NUMBER
PTP 55940	1	.312	11	.500	3/4	3 23/32	1/4	2040
PTP 55941	1	.312	11	.625	3/4	3 25/32	1/4	2040
PTP 55942	1 1/4	.400	9	.500	3/4	3 55/64	5/16	2050
PTP 55943	1 1/4	.400	9	.625	3/4	3 55/64	5/16	2050
PTP 55944	1 1/2	15/32	7	.500	3/4	3 3/4	7/16	2060
PTP 55945	1 1/2	15/32	7	.625	3/4	3 1/4	7/16	2060

IDLER SPROCKET DISPLAY

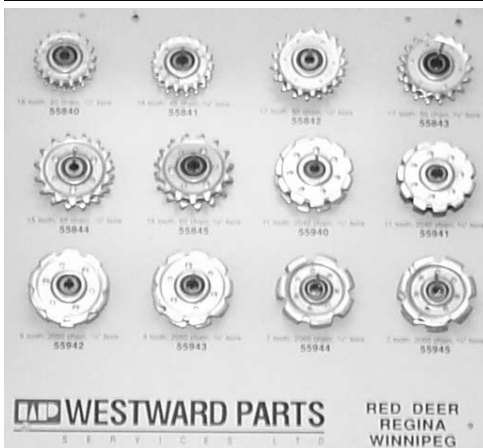

Includes:

- 2 - PTP 55840 18 tooth 40 chain 1/2" bore
- 2 - PTP 55841 18 tooth 40 chain 5/8" bore
- 2 - PTP 55842 17 tooth 50 chain 1/2" bore
- 2 - PTP 55843 17 tooth 50 chain 5/8" bore
- 2 - PTP 55844 15 tooth 60 chain 1/2" bore
- 2 - PTP 55845 15 tooth 60 chain 5/8" bore
- 2 - PTP 55940 11 tooth 2040 chain 1/2" bore
- 2 - PTP 55941 11 tooth 2040 chain 5/8" bore
- 2 - PTP 55942 9 tooth 2050 chain 1/2" bore
- 2 - PTP 55943 9 tooth 2050 chain 5/8" bore
- 2 - PTP 55944 7 tooth 2060 chain 1/2" bore
- 2 - PTP 55945 7 tooth 2060 chain 5/8" bore

Display Board is free with
Product Package order.

PART NO.	DESCRIPTION
PRM 558	Display Board

SET COLLARS



Mild Steel Set Collars

PART NO.	BORE	O.D.	WIDTH
PTP SC-3/16	3/16"	7/16"	1/4"
PTP SC-1/4	1/4"	1/2"	9/32"
PTP SC-5/16	5/16"	5/8"	11/32"
PTP SC-3/8	3/8"	3/4"	3/8"
PTP SC-7/16	7/16"	7/8"	7/16"
PTP SC-1/2	1/2"	1"	7/16"
PTP SC-9/16	9/16"	1"	7/16"
PTP SC-5/8	5/8"	1 1/8"	1/2"
PTP SC-11/16	11/16"	1 1/4"	9/16"
PTP SC-3/4	3/4"	1 1/4"	9/16"
PTP SC-13/16	13/16"	1 5/16"	9/16"
PTP SC-7/8	7/8"	1 1/2"	9/16"
PTP SC-15/16	15/16"	1 5/8"	9/16"
PTP SC-1	1"	1 5/8"	5/8"
PTP SC-1-1/16	1 1/16"	1 3/4"	5/8"
PTP SC-1-1/8	1 1/8"	1 3/4"	5/8"
PTP SC-1-3/16	1 3/16"	2"	11/16"
PTP SC-1-1/4	1 1/4"	2"	11/16"
PTP SC-1-5/16	1 5/16"	2 1/8"	11/16"
PTP SC-1-3/8	1 3/8"	2 1/8"	3/4"
PTP SC-1-7/16	1 7/16"	2 1/4"	3/4"

PART NO.	BORE	O.D.	WIDTH
PTP SC-1-1/2	1 1/2"	2 1/4"	3/4"
PTP SC-1-9/16	1 9/16"	2 1/2"	13/16"
PTP SC-1-5/8	1 5/8"	2 1/2"	13/16"
PTP SC-1-11/16	1 11/16"	2 1/2"	13/16"
PTP SC-1-3/4	1 3/4"	2 3/4"	7/8"
PTP SC-1-13/16	1 13/16"	2 3/4"	7/8"
PTP SC-1-7/8	1 7/8"	2 3/4"	7/8"
PTP SC-1-15/16	1 15/16"	3"	7/8"
PTP SC-2	2"	3"	7/8"
PTP SC-2-1/8	2 1/8"	3"	7/8"
PTP SC-2-3/16	2 3/16"	3 1/4"	15/16"
PTP SC-2-1/4	2 1/4"	3 1/4"	15/16"
PTP SC-2-5/16	2 5/16"	3 1/4"	15/16"
PTP SC-2-3/8	2 3/8"	3 1/4"	15/16"
PTP SC-2-7/16	2 7/16"	3 1/2"	1"
PTP SC-2-1/2	2 1/2"	3 1/2"	1"
PTP SC-2-9/16	2 9/16"	3 3/4"	1 1/8"
PTP SC-2-11/16	2 11/16"	4"	1 1/8"
PTP SC-2-3/4	2 3/4"	4"	1 1/8"
PTP SC-2-15/16	2 15/16"	4 1/4"	1 1/8"
PTP SC-3	3"	4 1/4"	1 1/8"

Note: Width and O.D. dimensions may vary slightly.

See Section 5 for Popular Sizes of Conveying Chain!

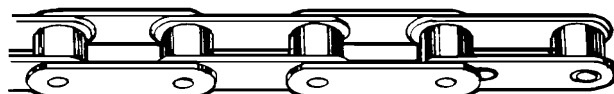

BROWNING COUPLINGS

You can always count on the right connection when you specify Browning couplings! Choose from over 17,000 different combinations of types, sizes and bores - entirely from stock - for shaft sizes from 1/4" to 8 7/8", and applications up to many thousands of horsepower as shown. Included are pin type, new jaw type, chain, Ever-Flex, sleeve, rigid and two new designs specifically intended for higher horsepower and rugged bulk material handling applications: the GRID-FLEX coupling with tapered grid, and a new family of Gear Couplings in flange and continuous sleeve designs.

Many Browning couplings are available with Browning's exclusive easy-on easy-off split taper bushing, as well as finished bore and minimum bore. Choose whichever you prefer, but choose Browning - and be sure of the right connection, every time!

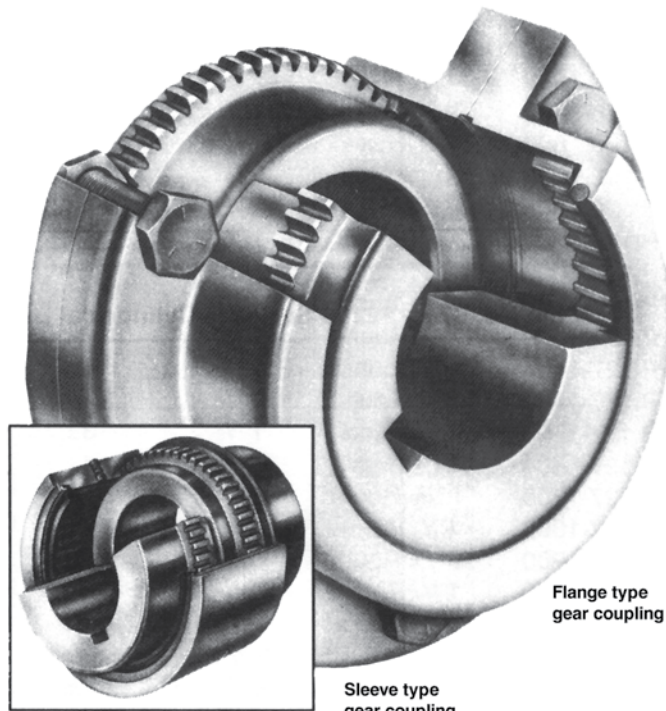

Flange type gear coupling

Sleeve type gear coupling

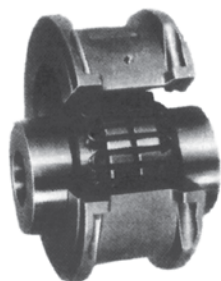

Grid-Flex coupling

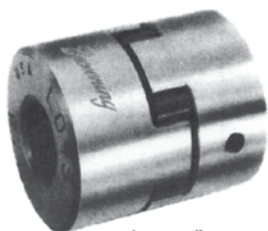

Jaw coupling



Ever-Flex coupling



Sleeve coupling



Pin type coupling

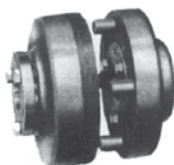

Rigid coupling



Chain coupling

Couplings

COUPLING TYPE		BORE SIZES	MAXIMUM HP @ 1800 RPM
Pin	Finished Bore - Die Cast	1/4" - 1 5/8"	9.6
	Finished Bore - Steel	3/8" - 1 1/4"	5.5
	Finished Type - Steel	3/8" - 3 3/4"	68.7
Jaw	Finished Bore	3/8" - 2 3/8"	180.0
	Bushing Type	3/8" - 3 3/4"	144.0
Chain	Finished Bore	1/2" - 2 3/8"	146.0
	Bushing Type	3/8" - 3 3/4"	588.0
	Minimum Bore	1/2" - 3 1/2"	588.0
Ever-Flex	Finished Bore	3/8" - 1 3/4"	74.6
	Bushing Type	3/8" - 4 1/4"	476.7
	Minimum Bore	3/8" - 3 1/4"	203.2
Gear	Rough Bore	3/4" - 8 7/8"	1020/100 RPM
Sleeve	Finished Bore	1/4" - 1 3/8"	-
	Bushing Type	3/8" - 2 11/16"	-
Rigid	Bushing Type	3/8" - 3 3/4"	-
Grid-Flex	Rough Bore	1/2" - 7 1/4"	6385
	Finished Bore	1/2" - 7"	6385
	Bushing Type	3/8" - 5 1/2"	5328

Westward Parts has available a full range of Browning Couplings.

SHAFT COUPLINGS

PART NO.	A BORE	B O.D.	C LENGTH THRU	D KEYWAY	E SETSCREWS
PTP 126-1000	5/8 Hex	1 1/2	2 1/2	None	2 1/4 x 20
PTP 126-1200	3/4 Hex	1 5/8	3	None	2 1/4 x 20
PTP 126-1400	7/8 Hex	1 3/4	3	None	2 1/4 x 20
PTP 126-1600	1 Hex	1 13/16	3	None	2 5/16 x 18
PTP 126-1800	1 1/8 Hex	2	4 1/2	None	2 5/16 x 18
PTP 126-2000	1 1/4 Hex	2 1/8	4 1/2	None	2 5/16 x 18
PTP 127-0800	1/2 Round	1 1/4	2	1/8	2 1/4 x 20
PTP 127-1000	5/8 Round	1 1/2	2 1/2	3/16	2 1/4 x 20
PTP 127-1200	3/4 Round	1 5/8	3	3/16	2 1/4 x 20
PTP 127-1300	13/16 Round	1 5/8	3 1/4	3/16	2 1/4 x 20
PTP 127-1400	7/8 Round	1 3/4	3 1/2	3/16	2 1/4 x 20
PTP 127-1500	15/16 Round	1 3/4	3 3/4	1/4	2 1/4 x 20
PTP 127-1600	1 Round	1 5/8	3	1/4	2 5/16 x 18
PTP 127-1604	1 Round	1 13/16	4	1/4	2 5/16 x 18
PTP 127-1700	1 1/16 Round	2	4 1/4	1/4	2 5/16 x 18
PTP 127-1800	1 1/8 Round	2	4 1/2	1/4	2 5/16 x 18
PTP 127-1900	1 3/16 Round	2	4 1/2	1/4	2 5/16 x 18
PTP 127-2000	1 1/4 Round	2 1/8	4 1/2	1/4	2 5/16 x 18
PTP 127-2005	1 1/4 Round	2 1/8	4 1/2	5/16	
PTP 127-2200	1 3/8 Round	2 5/16	4 1/2	5/16	2 3/8 x 16
PTP 127-2300	1 7/16 Round	2 5/16	4 1/2	3/8	2 3/8 x 16
PTP 127-2400	1 1/2 Round	2 1/2	4 1/2	3/8	2 3/8 x 16
PTP 127-2600	1 5/8 Round	2 5/8	4 1/2	3/8	2 3/8 x 16
PTP 127-2800	1 3/4 Round	2 3/4	4 1/2	3/8	2 3/8 x 16
PTP 127-3100	1 15/16 Round	3 5/16	4 1/2	1/2	2 1/2 x 13
PTP 127-3200	2 Round	3 5/16	4 1/2	1/2	2 1/2 x 13

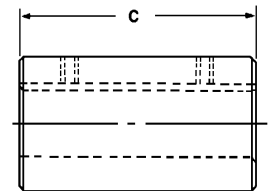
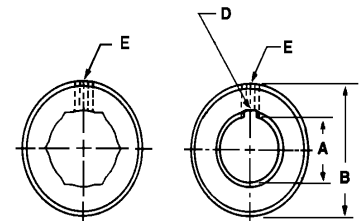

MAT. STEEL

See Section 5 for a full range of strong and rugged chain tools!

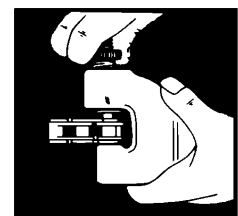
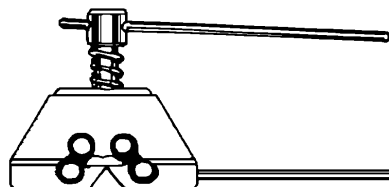
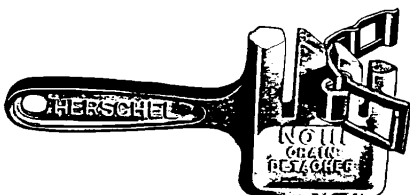

FLEXIBLE COUPLINGS

Interchangeable with Lovejoy Couplings

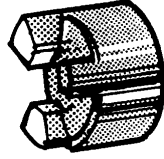

Body



Spider

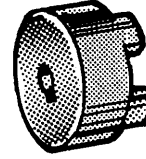

Body

SERIES	*CAPACITY AT 1200 RPM	*CAPACITY AT 1800 RPM	*CAPACITY AT 3600 RPM	OUTSIDE DIAMETER	OVERALL LENGTH COMPLETE	USE SPIDER
PTP L070	.84	1.26	2.52	1 3/8"	2"	L070N
PTP L075	1.68	2.52	5.04	1 3/4"	2 1/8"	L075N
PTP L090	2.76	4.14	8.28	2 1/8"	2 5/16"	L090-095N
PTP L095	3.60	5.40	10.8	2 1/8"	2 3/4"	L090-095N
PTP L099	6.00	9.00	18.0	2 9/16"	2 13/16"	L099-100N
PTP L100	7.92	11.9	23.8	2 9/16"	3 1/2"	L099-100N
PTP L110	15.00	22.5	45.0	3 15/16"	4 1/4"	L110N

*Capacity is calculated with a service factor of 1.0 and with BUNA-N inserts.

NOTE: Bodies are stocked individually. Order 2 bodies and 1 spider to make a complete coupling. We also stock L050N, L150N & L190N spiders.

Available in the following bore sizes:

NOTE: "X" designates items as standard stock. Larger sizes also available.

BORE SIZE	L070	L075	L090	L095	L099	L100	L110
1/2"	X	X	X	X	X	X	-
5/8"	X	X	X	X	X	X	X
3/4"	X	X	X	X	X	X	X
7/8"	-	X	X	X	X	X	X
15/16"	-	-	-	-	-	X	-
1"	-	-	X	X	X	X	X
1 1/8"	-	-	-	X	X	X	X
1 3/16"	-	-	-	-	-	X	-
1 1/4"	-	-	-	-	-	X	X
1 3/8"	-	-	-	-	-	X	X
1 7/16"	-	-	-	-	-	-	X
1 1/2"	-	-	-	-	-	-	X
1 5/8"	-	-	-	-	-	-	X

Spiders also available in bronze, urethane and Hytrel materials.

FLEXIBLE COUPLINGS

INSERT MATERIAL	COUPLING SIZE	MAX. BORE	MAX. RPM	TORQUE IN LBS.	HORSEPOWER CAPACITIES AT INDICATED SPEEDS (RPM)								
					50	100	300	600	900	1200	1800	3600	
BUNA-N	L035	3/8"	31000	3.52	0.0028	0.0056	0.0170	0.0340	0.0500	0.0670	0.1000	0.2000	
	L050	5/8"	18000	25.8	0.0205	0.0410	0.1230	0.2500	0.3700	0.4900	0.7400	1.4800	
	L070	3/4"	14000	44.1	0.0350	0.0700	0.2100	0.4200	0.6300	0.8400	1.2600	2.5200	
	L075	7/8"	11000	88.2	0.0700	0.1400	0.3800	0.7600	1.2600	1.6800	2.5200	5.0400	
	L090	1"	9000	145	0.1150	0.2300	0.6900	1.3800	2.0700	2.7600	4.1400	8.2800	
	L095	1 1/8"	9000	189	0.1500	0.3000	0.9000	1.8000	2.7000	3.6000	5.4000	10.8000	
	L099	1 3/16"	7000	315	0.2500	0.5000	1.5000	3.0000	4.5000	6.0000	9.0000	18.0000	
	L100	1 3/8"	7000	416	0.3300	0.6600	1.9800	3.9600	5.9400	7.9200	11.9000	23.8000	
	L110	1 5/8"	5000	788	0.6300	1.2500	3.7500	7.5000	1.3000	15.0000	22.5000	45.0000	
	L150	1 7/8"	5000	1260	1.0000	2.0000	6.0000	12.0000	18.0000	24.0000	36.0000	72.0000	
	L190	2 1/8"	5000	1702	1.3500	2.7000	8.1000	16.2000	24.3000	32.4000	48.6000	97.2000	
	L225	2 3/8"	4200	2332	2.8500	5.7000	17.1000	34.2000	51.3000	68.4000	102.6000	205.2000	
URETHANE	L070	3/4"	14000	66.2	0.0530	0.1050	0.3200	0.6300	0.9500	1.2600	1.8900	3.7800	
	L075	7/8"	11000	132	0.1050	0.2100	0.6300	1.2600	1.8900	2.5200	3.7800	7.5600	
	L090	1"	9000	217	0.1730	0.3450	1.0400	2.0700	3.1100	4.1400	6.2100	12.4000	
	L095	1 1/8"	9000	284	0.2250	0.4500	1.3500	2.7000	4.0500	5.4000	8.1000	16.2000	
	L099	1 3/16"	7000	473	0.3750	0.7500	2.2500	4.5000	6.7500	9.0000	13.5000	27.0000	
	L100	1 3/8"	7000	624	0.4950	0.9900	2.9700	5.9400	8.9100	11.9000	17.8000	35.6000	
	L110	1 5/8"	5000	1182	0.9380	1.8750	5.6300	11.3000	16.9000	22.5000	33.8000	67.5000	
	L150	1 7/8"	5000	1891	1.5000	3.0000	9.0000	18.0000	27.0000	36.0000	54.0000	108.0000	
	L190	2 1/8"	5000	2553	2.0300	4.0500	12.2000	24.3000	36.5000	48.6000	72.9000	145.8000	
	L225	2 3/8"	4200	3498	2.7800	5.5500	16.7000	33.3000	50.0000	66.6000	99.9000	199.8000	
	HYTREL® AND BRONZE*	L050	5/8"	18000*	50.4	0.0400	0.0800	0.2400	0.4800	0.7200	0.9600	1.4400	2.8800
		L070	3/4"	14000*	113	0.0900	0.1800	0.5400	1.0800	1.7700	2.1600	3.2400	6.4800
L075		7/8"	11000*	227	0.1800	0.3600	1.0800	2.1600	3.2400	4.3200	6.4800	13.0000	
L090		1"	9000*	391	0.3100	0.6200	1.8600	3.7200	5.5800	7.4400	11.2000	22.3000	
L095		1 1/8"	9000*	567	0.4500	0.9000	2.7000	5.4000	8.1000	10.8000	16.2000	32.4000	
L099		1 3/16"	7000*	788	0.6300	1.2500	3.7500	7.5000	11.3000	15.0000	22.5000	45.0000	
L100		1 3/8"	7000*	1134	0.9000	1.8000	5.4000	10.8000	16.2000	21.6000	32.4000	64.8000	
L110		1 5/8"	5000*	2269	1.8000	3.6000	10.8000	21.6000	32.4000	43.2000	64.8000	129.6000	
L150		1 7/8"	5000*	3706	2.9400	5.8800	17.6000	35.3000	52.9000	70.6000	105.8000	211.7000	
L190		2 1/8"	5000*	4683	3.7200	7.4300	22.3000	44.6000	66.9000	89.2000	133.7000	267.5000	
L225		2 3/8"	4200*	6303	5.0000	10.0000	30.0000	60.0000	90.0000	120.0000	180.0000	360.0000	

* NOTE: Couplings with bronze inserts limited to 250 RPM.

**For High Torque Applications
Try Chain Couplings.**

BROWNING JAW TYPE COUPLINGS

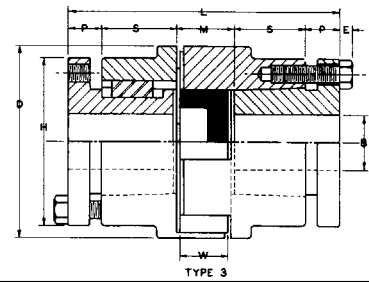
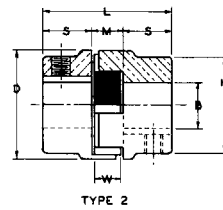
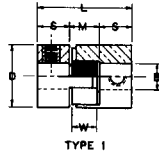
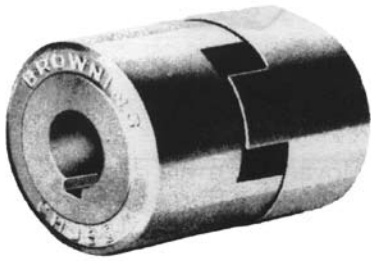

Specifications - Finished Bore

COUP* REF. NO.	HALF COUP PART NO.	TYPE	STOCK BORES MARKED "X"																D	H	L	S	M	W	WT. LBS. HALF COUP.
			3/8"	1/2"	5/8"	3/4"	7/8"	1"	1 1/8"	1 1/4"	1 3/8"	1 7/16"	1 1/2"	1 5/8"	1 7/8"	1 15/16"	2 1/8"	2 3/8"							
JP1	CHJP1	1	X	X	-	-	-	-	-	-	-	-	-	-	-	-	-	-	1 1/16	-	1 21/32	9/16	17/32	7/16	.1
JP2	CHJP2	1	X	X	X	X	-	-	-	-	-	-	-	-	-	-	-	-	1 3/8	-	2 1/32	3/4	17/32	7/16	.2
JP3	CHJP3	2	-	X	X	X	X	-	-	-	-	-	-	-	-	-	-	-	1 3/4	1 3/4	2 5/32	13/16	17/32	7/16	.3
JP4	CHJP4	2	-	X	X	X	X	X	X	-	-	-	-	-	-	-	-	-	2 1/8	2 1/8	2 1/2	31/32	9/16	7/16	.7
JP5	CHJP5	2	-	-	X	X	X	X	X	X	X	X	X	-	-	-	-	-	2 11/16	2 11/16	3 1/2	1 3/8	3/4	5/8	1.5
JS5	CHJS5	2	-	-	-	-	-	-	-	-	-	-	X	-	-	-	-	-	2 11/16	2 11/16	3 1/2	1 3/8	3/4	5/8	1.5
JS6	CHJS6	2	-	-	-	X	X	X	X	X	X	X	X	X	X	-	-	-	3 7/16	3	4 1/2	1 3/4	1	7/8	3.5
JS7	CHJS7	2	-	-	-	-	-	X	-	X	-	-	X	X	-	X	X	4 11/16	4 1/4	5 9/16	2 1/4	1 1/16	1 5/16	8.8	

*Packaged Half Couplings only. For complete couplings, order two halves and one insert.
 *Finished Bore Couplings with 1/2" bore have no keyways.

Specifications - Bushed Type

COU-PLING* REF. NO.	HALF* COUPLING PART NO.	BUSHING			DIMENSIONS								WT. LBS. HALF COUPLING
		TYPE	SIZE	BORE RANGES	D	H	L	S	M	W	P	E	
JS5H	CHJS5H	3	H	3/8" - 1 1/2"	2 11/16"	2 1/2"	3 1/4"	7/8"	3/4"	5/8"	3/8"	3/16"	1.7
JS6P	CHJS6P	3	P1	1/2" - 1 3/4"	3 7/16"	3"	5	1 3/8"	1"	7/8"	5/8"	1/4"	1.9
JS7Q	CHJS7Q	3	Q1	3/4" - 2 11/16"	4 11/16"	4 1/8"	6 3/16"	1 13/16"	1 1/16"	15/16"	3/4"	9/32"	5.0
JD9R	CHJS9R	3	R1	1 1/8" - 3 3/4"	7 1/4"	5 3/8"	7 1/16"	2 1/16"	1 3/16"	1 1/16"	7/8"	9/32"	14.5

*Packaged Half Couplings only. For complete couplings, order two halves and one insert. I.E.) PTP CHJP5-1 and 1 ea. PTP JS5 insert.

Rating Chart - Normal Service

COUPLING REF. NO.	MAX. BORE		HORSEPOWER CAPACITIES AT INDICATED SPEEDS							
	FIN. BORE	BUSHED TYPE	50	100	300	600	900	1200	1800	3600
NEOPRENE INSERTS - For Quiet Service, Normal Duty Applications										
JP1, JZ1	1/2"	-	-	.06	.18	.36	.55	.73	1.1	2.0
JP2, JZ2	3/4"	-	-	.08	.25	.50	.75	1.0	1.5	2.8
JP3, JS3	7/8"	-	-	.20	.60	1.2	1.8	2.4	3.6	6.6
JP4, JS4	1 1/8"	-	-	.33	1.0	2.0	3.0	4.0	6.0	11.0
JP5, JS5, JS5H	1 11/16"	1 1/2"	-	.69	2.0	4.1	6.1	8.2	12.3	22.7
JS6, JS6P	1 15/16"	1 3/4"	-	1.7	5.1	10.3	15.4	20.5	30.8	38.9
JS7, JS7Q	2 3/8"	2 11/16"	-	3.1	9.4	18.8	28.1	37.5	56.3	71.1
JS9R	-	3 3/4"	-	6.9	20.7	41.3	62.0	73.3	96.0	-

BROWNING JAW TYPE COUPLINGS



"FS" FINISHED BORE-STEEL
Finished Bore "FS" Couplings are machined from bar steel and have steel drive pins. they are equipped with Neoprene Inserts which are oil and grease proof as well as heat resistant. They are fitted with hollow head set screws and have standard keyseats.

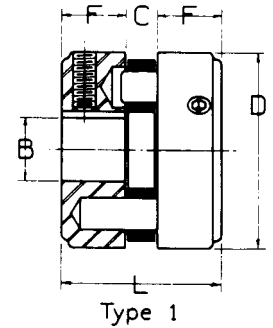

Specifications

COU-PLING REF. NO.*	HALF COU-PLING PART NO.	TYPE					WT. LBS. HALF COU-PLING	STOCK BORES MARKED "X"											
			D	L	F	C		3/8"	7/16"	1/2"	5/8"	3/4"	7/8"	15/16"	1"	1 1/8"	1 3/16"	1 1/4"	
FS1	CHFS1	1	1 3/4"	1 1/2"	9/16"	3/8"	.13	X	X	X	-	-	-	-	-	-	-	-	-
FS2	CHFS2	1	2"	1 5/8"	5/8"	3/8"	.50	X	X	X	X	X	-	-	-	-	-	-	-
FS3	CHFS3	1	2 5/8"	2 3/16"	7/8"	7/16"	1.00	-	-	X	X	X	X	X	X	-	-	-	-
FS4	CHFS4	1	3 1/4"	2 3/16"	7/8"	7/16"	1.75	-	-	-	-	X	X	-	X	X	-	-	X

*Packaged Half Couplings only. For complete couplings, order two halves and one insert. I.E.) PTP CHFS3-1/2 and 1 ea.

Standard Keyseats

BORE	KEYSEAT
3/8" - 1/2"	None
5/8" - 7/8"	3/16" x 3/32"
15/16" - 1 1/4"	1/4" x 1/8"

**SOLID
STEEL
ACCURATELY
MACHINED**

Inserts

COUPLING REF. NO.	INSERT PART NO.	WT. LBS.
FS1	FS1 Insert	.03
FS2	FS2 Insert	.03
FS3	FS3 Insert	.05
FS4	FS4 Insert	.07

Rating Chart - Normal Service

COU-PLING REF. NO.	MAX. BORE	HORSEPOWER CAPACITIES AT INDICATED SPEEDS							
		50	100	300	600	900	1200	1800	3600
FS1	1/2"	.03	.05	.13	.22	.25	.28	.34	.56
FS2	3/4"	.04	.08	.24	.49	.73	.98	1.47	2.71
FS3	1"	.13	.25	.75	1.48	1.81	2.16	2.75	4.58
FS4	1 1/4"	.20	.41	1.22	2.44	3.47	4.15	5.48	9.45
FS5H	1 1/2"	.40	.80	2.41	4.81	6.87	8.20	9.92	18.80
FS6P	1 3/4"	.86	1.72	5.15	9.85	12.06	14.10	18.00	27.50
FS7Q	2 11/16"	1.83	3.67	11.00	19.36	24.34	28.20	34.80	-
FS9R	3 3/4"	4.01	8.20	24.06	39.60	47.17	54.30	68.70	-

Smaller shafts in coupling bore range and short key applicatiosn may not transmit horsepowers listed above, check shaft and key stress.

FINISHED BORE CHAIN COUPLINGS

Stock Sizes Marked with "X"

COU- PLING* HALF NO.	STOCK BORES MARKED "X"																		
	1/2	5/8	3/4	7/8	1	1 1/8	1 3/16	1 1/4	1 3/8	1 7/16	1 1/2	1 5/8	1 3/4	1 7/8	1 15/16	2	2 1/8	2 1/4	
PTP C4012	A	A	A	-	-	-	-	-	-	-	-	-	-	-	-	-	-	-	-
PTP C4016	-	-	A	A	X	X	A	X	-	-	-	-	-	-	-	-	-	-	-
PTP C5016	-	-	A	A	X	A	A	X	A	A	A	A	-	-	-	-	-	-	-
PTP C5018	-	-	-	-	-	-	-	A	A	A	A	A	A	A	A	-	-	-	-
PTP C6018	-	-	-	-	-	-	-	X	-	A	X	A	A	A	A	A	A	X	-

*Half couplings only. For complete couplings, order two halves and one chain.

*Sizes marked with 'A' are special order.

*When ordering please specify the bore size. I.E.) PTP C5016-1

Standard Keyways

BORE RANGE	KEYWAY
1/2"	None
5/8" - 7/8"	3/16" X 3/32"
1" - 1 1/4"	1/4" X 1/8"
1 3/8"	5/16" X 5/32"
1 7/16" - 1 3/4"	3/8" X 3/16"
1 7/8" - 2 1/4"	1/2" - 1/4"
2 3/8"	5/8" - 5/16"

Finished Bore Chain couplings are made with Solid Steel Sprockets with Hardened Teeth, Standard Keyway and Hollow Head Set Screw.

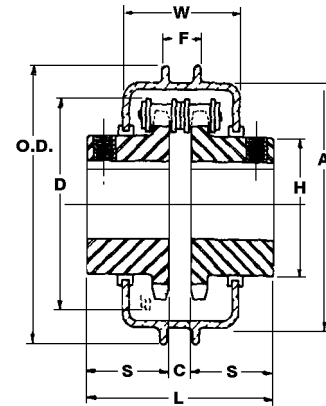

REPLACEMENT CHAIN

Replacement chains of correct length for each stock coupling are available from stock, individually packaged and complete with connecting links.



Chains for Couplings

COUPLING REF. NO.	CHAIN PART NO.	WT. LBS.
C4012	C40-12	0.4
C4016	C40-16	0.5
C5016	C50-16	1.2
C5018	C50-18	1.3
C6018	C60-18	2.2

BROWNING SLEEVE COUPLINGS



Browning Bushed Type Sleeve Couplings are machined from steel for use with Browning Mal-leable Split Taper Bushings.

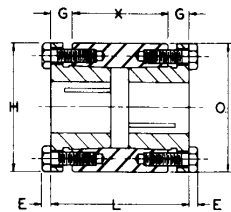

Type CSH

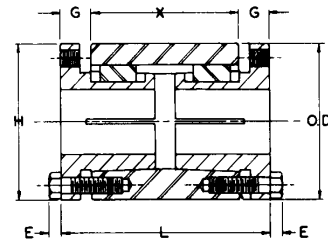

Type CSP and CSQ

Specifications

PART NO.	BUSHING		DIMENSIONS							WT. LBS.
	SIZE	BORE RANGE	O.D.	L	H	G	X	E	T°	
CSH	H	3/8" - 1 1/2"	2 1/2"	2 7/8"	2 1/2"	7/16"	2"	3/16"	1700	1.6
CSP	P1	1/2" - 1 3/4"	3"	4 1/4"	3"	5/8"	3"	1/4"	5660	9.6
CSQ	Q1	3/4" - 2 11/16"	4 3/8"	5 1/2"	4 1/8"	3/4"	4"	9/32"	14600	9.6

T° = Maximum recommended torque in inch/pounds for normal service. For shock loads reduce these ratings by 50%. Maximum torque shown is based on coupling strength. Smaller torque, check shaft and key stress.

Note: Order two bushings.

BROWNING BUSHING TYPE DRC CHAIN COUPLINGS

Split Taper Bushing Type

Browning Split Taper Bushing Type Chain Couplings are made with solid steel sprockets with hardened teeth. They are machined specifically for Browning's exclusive Split Taper Bushings, which are interchangeable in the full range of Browning sheaves, sprockets, gears, pulleys, hubs and other couplings.

Split Taper Bushing Type Chain Couplings - Specifications

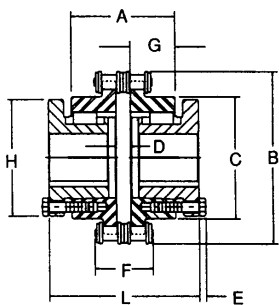

COUPLING HALF* HALF PART NO.	BUSHING		COUPLING DIMENSIONS - INCHES									WT. LBS. COUPLING
	SIZE	BORE RANGE	A	B	C	D	E	F	G	H	L	
C4020XH	H	3/8" - 1/2"	2 5/16"	3 21/32"	2 1/2"	5/16"	5/32"	1.194	1"	2 1/2"	3 1/16"	0.8
C5016XH	H	3/8" - 1 1/2"	2 1/4"	2 25/32"	2 1/2"	3/8"	5/32"	1.52	15/16"	2 1/2"	3 1/8"	0.9
C5018XP	P1	1/2" - 1 3/4"	3 3/16"	4 3/16"	2 31/32"	3/8"	13/64"	1.52	1 13/32"	3"	4 7/16"	1.8
C6018XP	P1	1/2" - 1 3/4"	3 3/16"	5 1/64"	3 1/2"	7/16"	13/64"	1.894	1 3/8"	3"	4 7/16"	3.0
C6020XB	B	1/2" - 2 7/16"	3 5/16"	5 1/2"	3 7/8"	7/16"	13/64"	1.894	1 7/16"	3 11/16"	4 3/4"	3.5
C8018XQ	Q1	3/4" - 2 11/16"	4 1/16"	6 11/16"	4 9/16"	9/16"	15/64"	2.432	1 3/4"	4 1/8"	5 9/16"	6.0
C10018XR	R1	1 1/8" - 3 3/4"	4 3/4"	8 3/8"	5 11/16"	3/4"	15/64"	2.962	2"	5 3/8"	6 1/2"	8.0

*Packaged half coupling only. For complete couplings, order two halves, two bushings, one coupling chain and one cover.

Horsepower Ratings for Chain Couplings with Split Taper Bushings



COUPLING SIZE.	BELOW 50 RPM MAX. TORQUE	HORSEPOWER AT INDICATED SPEEDS											MAX. RPM. WITH COVER*
		50	100	200	300	400	600	900	1200	1500	1800	3600	
C4020XH	220	2.09	4.19	6.61	8.79	10.72	14.57	20.36	25.13	30.16	35.43	63.33	4,000
C5016XH	220	2.09	4.19	6.61	8.79	10.72	14.57	30.36	25.13	30.16	35.43	63.33	4,000
C5018XP	525	5.00	10.00	15.00	21.00	25.00	33.00	48.58	57.00	67.00	79.00	145.00	4,000
C6018XP	708	6.74	13.48	21.29	28.30	34.51	46.91	65.51	80.88	97.06	114.04	-	3,000
C6020XB	708	6.74	13.48	21.29	28.30	34.51	46.91	65.51	80.88	97.06	114.04	-	3,000
C8018XQ	1750	16.66	33.32	52.64	69.97	85.30	115.95	161.93	199.92	239.90	281.89	-	2,000
C10018XR	2750	26.18	52.36	82.73	109.95	134.04	182.21	254.47	314.16	376.99	442.97	-	1,800

For maximum service life, a cover with proper lubrication is required for couplings selected with ratings to the right of the heavy line.
* WARNING - Couplings with covers must not be operated beyond this speed.

BROWNING COUPLERS & REPLACEMENT CHAIN



CHAIN COUPLING COVERS

Browning Chain Coupling Covers extend the life of the couplings by providing continuous lubrication and protection from abrasive and corrosive conditions. They are fitted with Neoprene seals, standard 1/8" pipe plugs and "Nyloc" cap screws, and fit all Browning chain couplings - finished bore, minimum bore, split taper bushing type and taper bore bushings type.

CAUTION - Browning chain coupling covers should not be operated at speed exceeding 5000 RPM rim speed.

Aluminum Covers

COVER PART NO.*	COUPLING REF. NO.	DIMENSIONS		WT. LBS.	ACCESSORY KIT**	
		A	F		PART NO.	WT. LBS.
AL40	C4012 C4016	2"	4"	0.75	AL4012AK AL4016AK	0.2 0.2
AL4020	C4020	2 3/8"	5 1/8"	1.25	AL4020AK	0.3
AL50	C5016 C5018	2 3/8"	5 1/8"	1.25	AL5016AK AL5018AK	0.3 0.3
AL60	C6018 C6020	2 15/16"	6 3/8"	2.25	AL6018AK AL6020AK	0.5 0.5
AL80	C8018 C8020	4"	8 3/16"	4.50	AL8018AK AL8020AK	0.7 0.7
AL100	C10018 C10020	5 1/4"	10 1/8"	12.25	AL10018AK AL10020AK	1.0 1.0

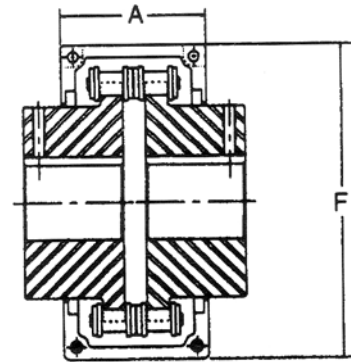

*Cover includes 2 cover halves, 4 seals (except 2 seals for AL4020), gaskets and all necessary hardware for installation.

**Accessory Kit includes 2 seals for specified hub, 2 gaskets and all necessary hardware for reinstallation.

Chains for Couplings

COUPLING REF. NO.	CHAIN PART NO.	WT. LBS.
C4012	C4012	0.4
C4016	C4016	0.5
C4020	C4020	0.7
C5016	C5016	1.2
C5018	C5018	1.3
C6018	C6018	2.2
C6020	C6020	2.6
C8018	C8018	5.3
C8020	C8020	5.9
C10018	C10018	9.8
C10020	C10020	10.9

REPLACEMENT CHAIN

Replacement chains of correct length for each stock coupling are available from stock, individually packaged and complete with connecting links.

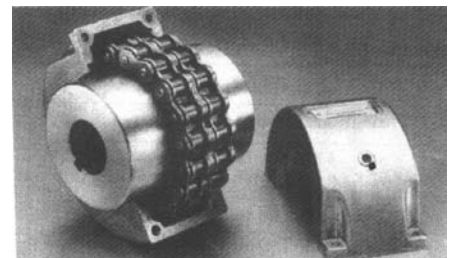
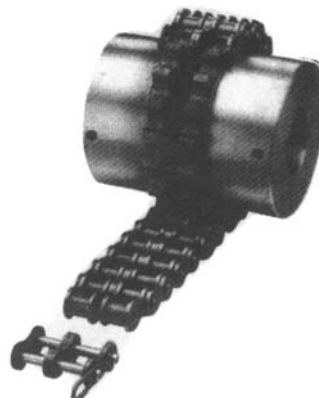

"R-FLEX" COUPLINGS

For Applications up to 206 HP at 1,800 rpm
Shaft sizes from 3/8" to 2 3/8"

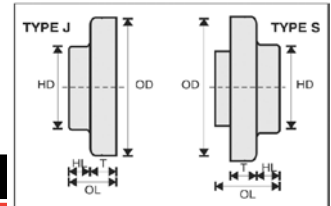

Flange Dimensions & Specifications

FLANGE					DIMENSIONS					BORE RANGE	
SIZE	TYPE	NO.	MATERIAL	WEIGHT (LBS)	OL	T	HL	OD	HD	MIN.	MAX.
3	J	3J	Die Cast	.3	51/64"	25/64"	13/32"	2.06"	1 1/4"	3/8"	3/4"
4	J	4J	Die Cast	.4	55/64"	7/16"	27/64"	2.46"	1 5/8"	1/2"	1"
5	J	5J	Die Cast or Cast Iron	1	1 3/64"	19/32"	29/64"	3.25"	1 7/8"	1/2"	1 1/8"
6	J	6J	Die Cast or Cast Iron	2	1 15/64"	5/8"	39/64"	4.00"	2 1/2"	5/8"	1 3/8"
6	S	6S	Cast Iron	2	*1 5/8"	25/32"	17/32"	4.00"	2 1/2"	5/8"	1 5/8"
7	S	7S	Cast Iron	3	1 27/32"	25/32"	11/16"	4.63"	2 13/16"	5/8"	1 5/8"
8	S	8S	Cast Iron	4	2 3/32"	29/32"	3/4"	5.45"	3 1/4"	3/4"	2 1/8"
9	S	9S	Cast Iron	7	2 13/32"	1 1/32"	25/32"	6.35"	3 5/8"	7/8"	2 3/8"

*1 5/16" for 1 5/8"

NOTE: Die cast flanges ARE NOT suitable for reworking. All Cast Iron flanges ARE suitable for reworking (bores, keyways, etc.) to recommended maximum bores.

Bore Sizes Available - Standard Keyways

*PART NO.	3/8"	1/2"	5/8"	3/4"	7/8"	1"	1 1/8"	1 3/16"	1 1/4"	1 3/8"	1 7/16"	1 1/2"	1 5/8"	1 3/4"	1 7/8"	1 15/16"	2"	2 1/8"	2 3/16"	2 1/4"	2 3/8"	
PTP 3J__	•	•	•	•																		
PTP 4J__		•	•	•	•	•																
PTP 5J__		•	•	•	•	•	•															
PTP 6J__			X	•	•	•	•	•	•	•	•	•	•	•	•	•	•	•	•	•	•	•
PTP 7J__			o	•	•	•	•	•	•	•	•	•	•	•	•	•	•	•	•	•	•	•
PTP 8J__				o	•	•	•	•	•	•	•	•	•	•	•	•	•	•	•	•	•	•
PTP 9J__					o	•	•	•	•	•	•	•	•	•	•	•	•	•	•	•	•	•

*Fill in __ with bore size when ordering.

- - with standard keyway and 2 set screws
- S - same as above available in 'S' flanges only
- o - plain bore with 2 set screws
- + - shallow key supplied with these bores available in 'S' flanges only
- x - "J" flange supplied with standard keyway and 2 set screws
- "S" flange supplied with plain bore and 2 set screws

Standard Keyways

BORE RANGE	3/8"	1/2" X 9/16"	5/8" X 7/8"	15/16" X 1 1/4"	1 5/16" X 1 3/8"	1 7/16" X 1 3/4"	1 3/16" X 2 1/4"	2 5/16" X 2 3/8"
KEYWAY SIZES	3/32" X 3/64"	1/8" X 1/16"	3/16" X 3/32"	1/4" X 1/8"	5/16" X 5/32"	3/8" X 3/16"	1/2" X 1/4"	5/8" X 5/16"

Bore Tolerances

BORE RANGE	TOLERANCE
up to 1 7/16"	+.0015/-.000
over 1 1/2"	+.002/-.000

"R-FLEX" COUPLINGS

Sleeve Dimensions

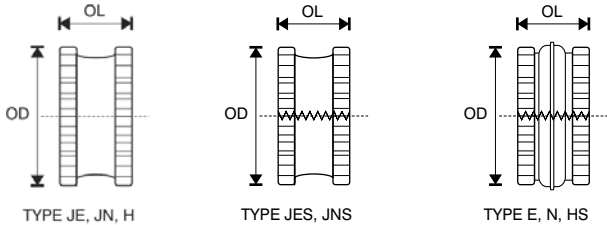

(1)
Weights of
JE-JN-
JES-JNS
Sleeves

(2)
Weights of
E-N
Sleeves

(3)
Weights of
H-HS
Sleeves

JE = EPDM
JN = Neoprene
JES = EPDM Split
JNS = Neoprene Split

SIZE	SOLID	1-PIECE SPLIT	2-PIECE SPLIT	WEIGHT (1) LBS.	WEIGHT (2) LBS.	WEIGHT (3) LBS.	OL	OD
3	3JE - 3JN	3JES - 3JNS	-	.06	-	-	1"	1 7/8"
4	4JE - 4JN	4JES - 4JNS	-	.10	-	-	1 1/4"	2 5/16"
5	5JE - 5JN	5JES - 5JNS	5E - 5N	.20	.25	-	1 9/16"	2 15/16"
6	6JE - 6JN - 6H	6JES - 6JNS	6E - 6N - 6HS	.40	.49	.44	1 7/8"	3 3/4"
7	7JE - 7JN - 7H	7JES - 7JNS	7E - 7N - 7HS	.62	.77	.69	2 3/16"	4 11/32"
8	8JE - 8JN - 8H	8JES - 8JNS	8E - 8N - 8HS	1.13	1.40	1.40	2 1/2"	5 1/16"
9	9JE - 9H	9JES	9E - 9N - 9HS	1.46	2.00	1.80	3"	6"

Sleeve Specifications

TYPE	JE-JES	E	JN-JNS	N	H	HS
Material	EPDM Rubber		Neoprene Rubber		Hytrel	
Construction	1 Piece	2 Piece	1 Piece	2 Piece	1 Piece	2 Piece
Temperature Range	-30°F to +275°F -34°C to +135°C		0°F to +200°F -18°C to +93°C		-65°F to +250°F -54°C to +121°C	
Torsional Flexibility	15°		15°		7°	

Caution: Hytrel sleeves will transmit up to 4 times the ratings of the EPDM or Neoprene sleeves. They should not be used to replace an EPDM or Neoprene sleeve or used with J-flanges.

COUPLING SIZE	3	4	5	6		7		8		9	
Sleeve Material	JE	JE	JE	JE	H	JE	H	JE	H	JE	H
Maximum RPM	9200	7600	7600	6000		5250		4500		3750	
Maximum Parallel Misalignment (in.)	.010	.010	.015	.015	.010	.020	.012	.020	.015	.025	.017
Maximum Angular Misalignment (in.)	.035	.043	.056	.070	.016	.081	.020	.094	.025	.109	.028

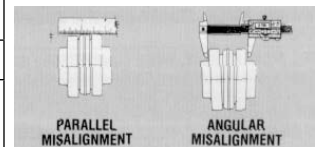

JES-E-JN-JNS-N Sleeves have the same values as JE sleeves.

Caution: All of the values for misalignments shown above apply only when the torque transmitted by the coupling is more than 1/4 of the coupling rating. If the torque loads are less than 1/4 of the coupling rating, then reduce the misalignment ratings by 50%.

"R-FLEX" COUPLINGS

Coupling Dimensions and Specifications

COUPLING	OL	OD	RD*	G +
3J	1 31/32"	2.06"	5/8"	3/8"
4J	2 11/32"	2.46"	5/8"	5/8"
5J	2 27/32"	3.25"	13/16"	3/4"
6J	3 11/32"	4.00"	1"	7/8"
6S	3 1/2"	4.00"	1 3/32"	7/8"
7S	3 15/16"	4.63"	1 5/16"	1"
8S	4 7/16"	5.45"	1 1/2"	1 1/8"
9S	5 1/16"	6.35"	1 3/4"	1 7/16"

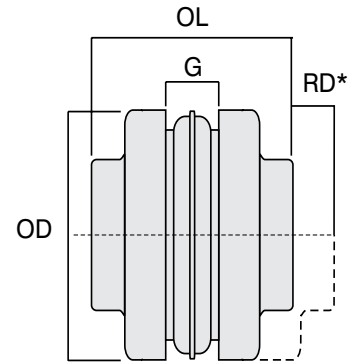

* Distance required to remove sleeve
+ Nominal dimensions (for reference only)

Torque-Horsepower Ratings

EPDM Sleeve

COUPLING NO.	TORQUE (IN LBS.)	HP PER 100 RPM	HP/SPEEDS (RPM)			
			900	1200	1800	3600
3	60	.095	.86	1.14	1.71	3.42
4	120	.190	1.71	2.28	3.42	6.85
5	240	.381	3.42	4.57	6.85	13.71
6	450	.714	6.43	8.57	12.85	25.70
7	725	1.150	10.35	13.80	20.71	41.41
8	1135	1.800	16.21	21.61	32.42	64.83
9	1800	2.860	25.70	34.27	51.41	102.80

Hytrek Sleeve

COUPLING NO.	TORQUE (IN LBS.)	HP PER 100 RPM	HP/SPEEDS (RPM)			
			900	1200	1800	3600
6	1800	2.86	25.7	34.3	51.5	103.0
7	2875	4.56	41.0	54.7	82.1	164.0
8	4530	7.19	64.7	86.3	129.4	259.0
9	7200	11.43	103.0	137.0	206.0	411.0

"R-FLEX" COUPLING SELECTION

NOTE: These applications depict the generally accepted conditions encountered in industry. Conditions subject to extreme temperatures, abrasive dusts, corrosive liquids and dusts, excessively high starting torques, etc. must be considered as extra heavy shock loads. These conditions will increase the service factors. Consult factory for these selections.

Prime Mover Classification

PRIME MOVER	CLASS
Turbines	A
Electric Motors (Standard Duty)	B
Electric Motors (High Torque)	C

TYPICAL APPLICATIONS	LOAD CHARACTERISTICS	PRIME MOVER CLASS		
		A	B	C
AGITATORS (paddle, propeller, screw), BLOWERS (centrifugal, vane), BOTTLING MACHINES, CLARIFIERS, COMPRESSORS (centrifugal, screw, lobe), CONVEYORS (apron, belt, flight, oven, screw, sawdust), DISTILLING (brew kettles, cookers, mash tubs), DYNAMOMETERS, ESCALATORS, FANS (centrifugal), FEEDERS (apron, belt, disc), FOOD (cookers), GENERATORS (uniform, load), LINE SHAFTS, PAPER (bleachers), PUMPS (centrifugal, axial), SCREENS (air, washing, water), SEWAGE (bar screen, chemical feeders, collectors, grit collector), STOKERS, TEXTILE (batches, mangle soapers), TIRE PRESS OPENERS, WOODWORKING MACHINERY	Uniform (Light) <ul style="list-style-type: none"> no shock even loads non reversing infrequent starts low starting torques 	1.00	1.25	1.50
BAKING (dough mixers), BLOWER (lobe), BUCKET ELEVATORS, CABLE REELS, CAR PULLERS, CLAY WORKING MACHINERY, CONVEYOR (bucket), CONCRETE MIXERS, COOLERS, CRANES, DREDGES (cable reels, pumps, utility winches, stacker), DRYERS, FANS (forced draft, large industrial, mine), GENERATORS (varying load), HAMMERMILLS (light intermittent duty), HOISTS (medium duty), LUMBER (band resaw, circular resaw, slab conveyors, sorting tables), MACHINE TOOLS (main drive), MEAT GRINDERS, METAL (bending rolls, forming machines, planers, punch presses, slitters, wire winders), OIL (chillers, filter presses), PAPER (beaters and pulpers, calenders, converting machines, couch, notching, printing presses, punches, rewinders, suction rolls, washers, thickeners, winders), PUG MILLS, PUMPS (gear, lobe, vane), ROTARY DRYERS, ROTARY SCREENS (coal or sand), SCREW FEEDERS, SEWAGE (dewatering screens), SUGAR (cane knives), TEXTILE (looms, spinners, tenter frames, winders), WINCHES, WINDGLASS, WOOD (planers)	Moderate Shock (Medium) <ul style="list-style-type: none"> moderate shock uneven loads moderate starting torques 	1.25	1.50	2.00
BRICK PRESSES, CANE SUGAR CRUSHERS, CAR DUMPERS, CEMENT KILNS, COOLING TOWER FANS, DRAW BENCH DRIVES, DREDGES (cutter head drive, Jig drive, screen drive), ELEVATORS (freight, man lift, passenger, service), HAMMERMILLS (continuous heavy duty), HOISTS (heavy duty), LAUNDRY (washers), LUMBER (barking, edgers, log haulers), METAL (extruders, wire drawing), MINES (heavy duty cranes and hoists), MILLS (ball, pebble rod, tube, rubber tumbling), ORE CRUSHERS, PAPER (heavy duty calender, chippers, cutters, cylinders, jordan, pulp grinders), PULLERS (barge haul), RECIPROCATING FEEDERS, ROD MILLS, RUBBER (calender, banbury mixers), STONE CRUSHERS, TEXTILE (card machines), TIRE GUILDING MACHINES, TUMBLING BARRELS, VIBRATING SCREENS, WELDER GENERATORS	Heavy Shock (Heavy) <ul style="list-style-type: none"> heavy shock uneven loads frequent starts and stops high starting torques high inertia peak loads 	1.50	2.00	2.50

BROWNING STOCK GEARS

Browning offers one of the most comprehensive lines of off-the-shelf gears in the industry, including spur, helical, miter and bevel, worm and change gears. These are available in 20° pressure angle from 20 to 4 dp, and 14 1/2° pressure angle from 48 to 3 dp...all designed to increase output, reduce costs and avoid specials.

- Thousands of shaft-ready finished bore and bushing types (a Browning exclusive) eliminate rework costs, assure true-running precision at all times.
- More stock sizes made of steel...you get weldability plus greater strength, at cast iron prices.
- Extra tooth depth and larger radii provide stronger teeth, a deeper lubrication reservoir and more clearance.
- Many helical and bevel gears are available hardened for longer life. Most worms are hardened and ground.
- Many odd-tooth sizes.
- Custom gear capabilities - up to 60" dia. and 17" face.

All Browning gears meet AGMA quality standards and our own close manufacturing tolerances. Gear up with Browning to increase your productivity!

Westward has available a full range of Browning gears and gear racks.

CONTACT YOUR NEAREST BRANCH FOR AVAILABILITY.

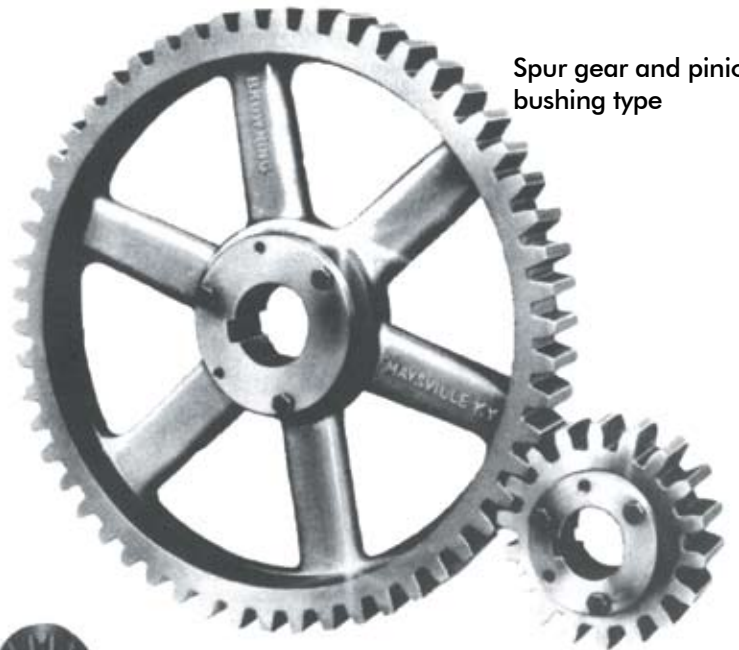

Spur gear and pinion, bushing type



Parallel helical gears



Bevel Gears

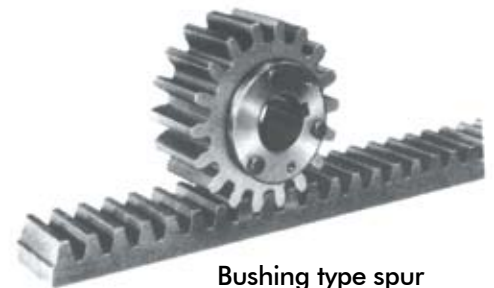

Bushing type spur gear and rack

BROWNING STOCK GEARS

A full range of gears are available.

STOCK GEARS					
Type	Material	Pressure Angle	Pitch Range	Tooth Range	Bore Range
SPUR GEARS					
Spur, Min. Bore (Fine Pitch)	Brass	14 1/2°	48, 24	6 - 180	3/32" - 5/8"
	Steel		32, 24, 20	11 - 200	3/32" - 1"
Spur, Min. Bore	Steel & Cast Iron	14 1/2°	16, 12, 10, 8, 6, 5, 4, 3	15 - 200	3/8" - 4 1/4"
Spur, Fin. Bore			20, 16, 12, 10, 8, 6	12 - 240	1/4" - 1 1/4"
Spur, Bushing Type			16, 12, 10, 8, 6, 5, 4, 3	15 - 200	3/8" - 4 1/4"
Spur, Min. Bore	Steel & Cast Iron	20°	20, 16, 12, 10, 8, 6, 5, 4	12 - 240	5/16" - 3 5/8"
Spur, Fin Bore			20, 16, 12, 10, 8, 6	12 - 40	1/4" - 1 1/4"
Spur, Bushing Type			16, 12, 10, 8, 6, 5, 4	18 - 240	3/8" - 4 1/4"
Spur, Change Gear	Steel	14 1/2°	20, 16, 12, 10, 8	20 - 129	5/8" - 1 3/8"***
Rack	Brass	14 1/2°	48, 32, 24, 16		
	Steel	14 1/2°	32, 24, 20, 16, 12, 10, 8, 6, 5, 4, 3		
	Steel	20°	20, 16, 12, 10, 8, 6, 5, 4		
Spur, Min. Bore	Non-Metallic	14 1/2°	16, 12, 10, 8, 6, 5	12 - 96	3/8" - 2 1/4"
		20°	16, 12, 8	15 - 24	3/8" - 1 3/4"
Stem Pinions	Steel	14 1/2°	20, 16, 12, 10, 8, 6	5 - 10	
BEVEL AND MITER GEARS					
Bevel	Unhardened Steel	20°	20, 16, 14, 12, 10, 8, 6, 5, 4, 3	10 - 96	3/16" - 3"
Miter	Hardened & Unhardened Steel	20°	32, 24, 20, 16, 14, 12, 10, 8, 6, 5, 4	12 - 32	3/16" - 3"
Spiral Bevel	Hardened Steel	20°	14, 10, 8	16 - 34	1/2" - 1 1/2"
Spiral Miter			12, 10, 8, 7, 6, 5	15 - 28	1/2" - 1 3/8"
WORMS AND WORM GEARS					
Worm and Gear Single Thread	Cast Iron & Bronze Worm Gears	14 1/2°	32, 24, 16, 12, 10, 8, 6, 5, 4, 3	20 - 128	3/16" - 2 7/8"
	Steel Worms	14 1/2°	32, 24, 16, 12, 10, 8, 6, 5, 4, 3	(.438 - 4.0 pd)	3/16" - 1 1/2"
Worm and Gear Double Thread	Cast Iron & Bronze Worm Gears	20°	32, 24, 16, 12, 10, 8, 6	20 - 128	1 13/16" - 1"
	Steel Worms	20°	32, 24, 16, 12, 10, 8, 6		
Worm and Gear Quadruple Thread*	Cast Iron & Bronze Worm Gears	25°	32, 24, 16, 12, 10, 8, 6	20 - 100	3/16" - 1 13/16"
	Steel Worms	25°	32, 24, 16, 12, 10, 8, 6		
HELICAL GEARS					
Helical (45° Helix)	Steel & Bronze	14 1/2°	24, 16, 12, 10, 8, 6	8 - 72	3/16" - 1 1/4"

*Triple thread available in 20° PA, 5 pitch, 29-50 tooth bronze worm gears & steel worms.

**Bushings bore range is 7/16" - 1 1/8"

BROWNING MOUNTED BEARINGS

Browning bearing technology pays off on the application - where it counts most - through rugged design, low maintenance and wide selection.

Choose from all these optimum selectivity factors:

- Ball bearings in two complete series of matching sizes and mounts; Masterline for top-of-the-line quality and wide range of mounts; Valuline for maximum economy combined with high serviceability. 1/2" to 3 15/16" bores, setscrew and eccentric lock.
- Tapered roller bearings, 1" - 5" bores, using unique Centrap or flinger grease seals to keep out dirt and contaminants.
- Spherical roller bearings - 1000 series with 1 1/8" to 4" bores; rugged 22500, 22200 and 23000 series with 2 7/16" to 9 1/2" bores; and new 1100 series offering the rugged extra strength of ductile housings, in bores up to 3 1/2".
- High and low series pillow blocks.
- Two, three and four-hole flange blocks.
- Eccentric locking, setscrew locking, adapter mount or interference fit.
- Side-mounted or protected screw type take-ups with patented top removal feature.

Wide selection, exclusive features, delivery from stock...all make it logical to look to Browning for a direct bearing on lower costs!

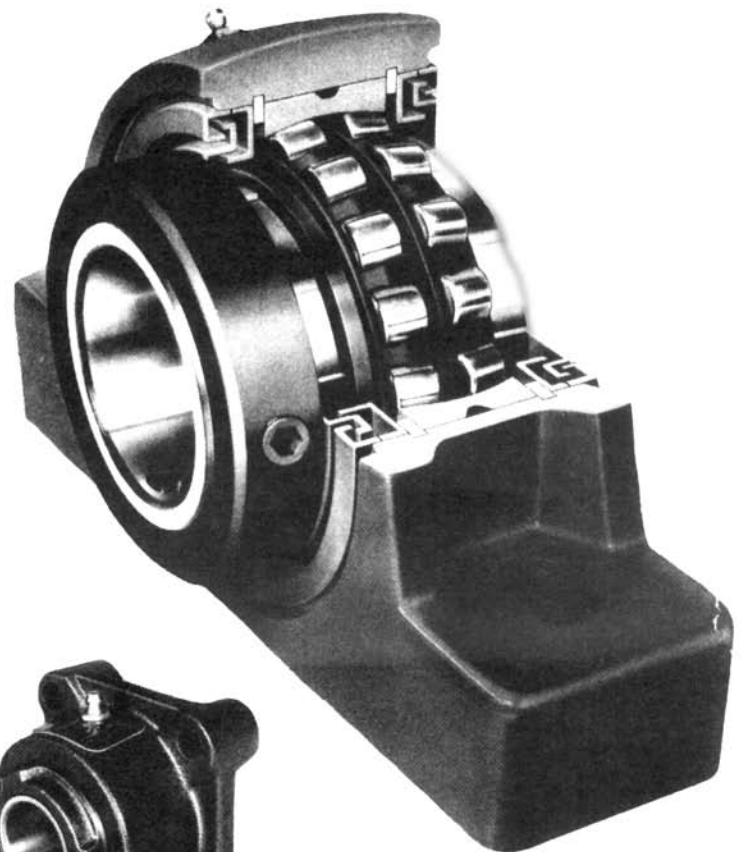
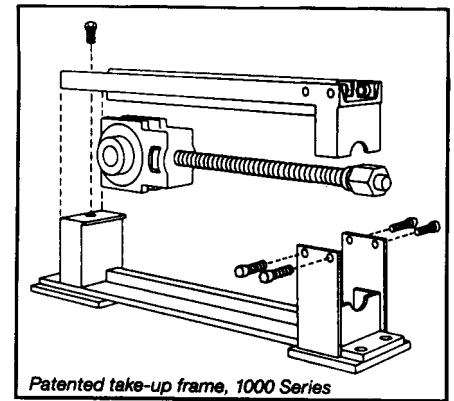

Tapered roller bearing flange block, E920 Series

Spherical roller bearing pillow block, 1000 series

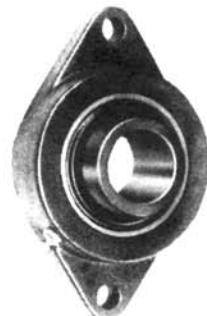

Valuline ball bearing flange block, 200 Series

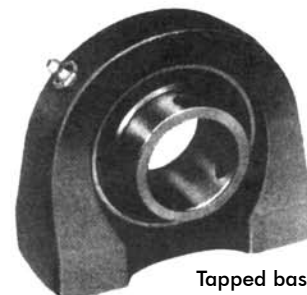

Tapped base pillow block 200 Series

BROWNING MOUNTED BEARINGS

BALL BEARING UNITS

Series	Type Lubrication	Type Locking	Bore Sizes		Take-Up Frames Range of Travel
			Pillow Block (High & Low Series)	Flange Block (2, 3 & 4 Hole)	
100	Relube & Non-Relube (Valuline)	Setscrew & Eccentric	1/2" - 1 7/16" **	1/2" - 1 7/16" **	-
200*	Relube & Non-Relube (Valuline & Masterline)	Setscrew & Eccentric	1/2" - 2 7/16"	1/2" - 2 15/16"	1 1/2" - 18"
300	Relube & Non-Relube (Valuline & Masterline)	Setscrew & Eccentric	1" - 3 15/16"	1" - 3 15/16"	3" - 18"

*Also available in tapped base type, 2" max bore.

**Also available with Malleable housings.

Note: 100 Series have narrow inner ring; 200 and 300 Series have wide inner ring.

TAPERED ROLLER BEARING UNIT

900	Relube/Centrap Seal	Eccentric	1" - 5"	1 - 4	12 - 24
E920	Relube	Setscrew (2 Collars)	1 3/16" - 5"	1 3/16" - 4"	12 - 30
950	Relube/Centrap Seal Expansion & Non-expansion - Self-aligning	Eccentric	1 7/16" - 5"	1 7/16" - 5"	-
970	Relube/Face Contact Seals - Expansion & Non-expansion - self aligning	Setscrew (2 Collars)	1 7/16" - 5"	1 7/16" - 5"	-

SPHERICAL ROLLER BEARING UNITS

1000	Relube/Multi-Trap Seal Expansion & Non-expansion - self-aligning	Setscrew	1 1/8" - 4"	1 1/8" - 4"	12 - 30
1100	Relube/Multi-Trap Seal Expansion & Non-expansion - self-aligning	Setscrew	1 5/16" - 3 1/2"	1 5/16" - 3 1/2"	-
22500	Relube - Triple Labrynth Seal Expansion - Non-expansion	Adapter Mount	2 7/16" - 8"	-	18 - 48
22200		Interference Fit	80 - 220mm	-	-
23000		Adapter Mount	8 7/16" - 9 1/2"	-	-

SINTERED BRONZE BEARING UNITS, SPHERICAL BEARING CARTRIDGE

50	Felt-packed Oil Reservoir		1/2" - 1 1/4"	1/2" - 1	-
----	---------------------------	--	---------------	----------	---



Tapered roller bearing pillow blocks, E920 Series

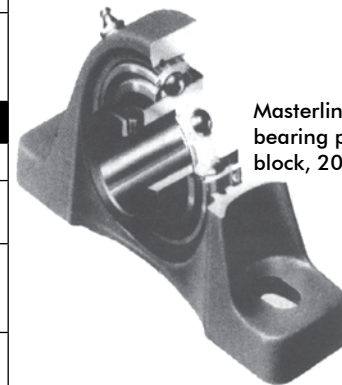

Masterline ball bearing pillow block, 200 Series

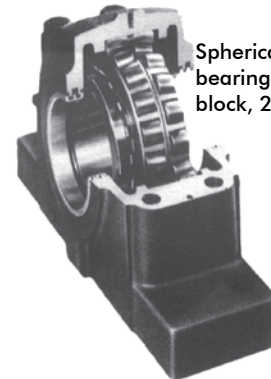

Spherical roller bearing pillow block, 22500 Series

Westward Parts has available a full range of Browning mounted bearing units.

Contact your nearest branch for availability.

BROWNING SPEED REDUCERS

Advanced gear technology makes the critical difference.

Through advanced technology in gear engineering and manufacturing, Browning continues to bring innovative new speed reducer designs to industry...

- New RAIDER worm gear speed reducers which are available in four basic units and standard component accessories that provide over 10 million different reducer configurations.
- RANGER worm gear speed reducers with aluminum housings, whose space-saving, lighter weight design provides up to 50% savings in performance and economy.
- Helical shaft mount reducers with exclusive patented TorqTaper bushing for easy-on easy-off mounting power and longer service life, with more than 20,000 stock configurations.

To assure consistent dependability and long service life, Browning utilizes the most modern methods of production and quality control. For example, carburized and ground gearing, AGMA rated for new higher capacities in less space...precision gear inspection laboratory to check indexing errors down to 20 millionths accuracy...and an audiometric chamber for testing noise as low as 55 decibels.

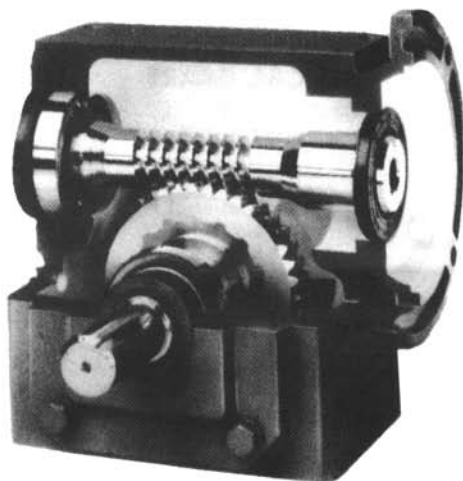

New RAIDER worm gear speed reducer

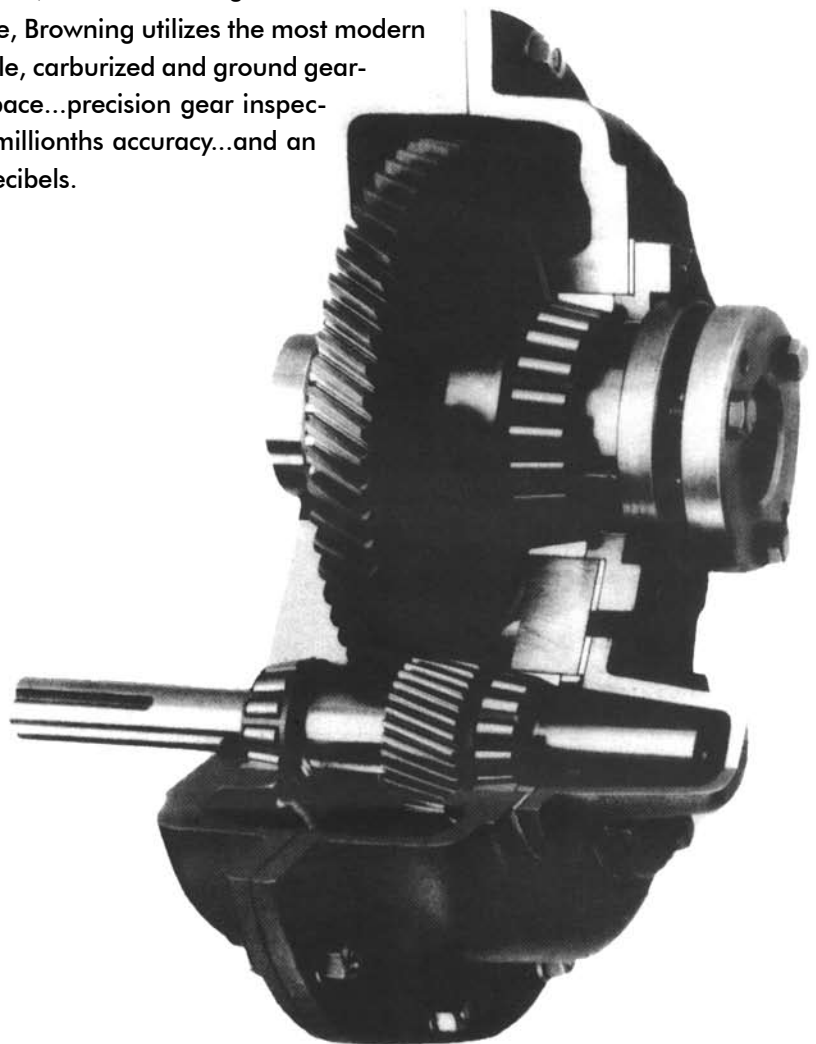

Helical shaft mount reducer with exclusive Torq-Taper bushing

Westward Parts has available a full range of Browning speed reducers. Contact your nearest branch for availability.

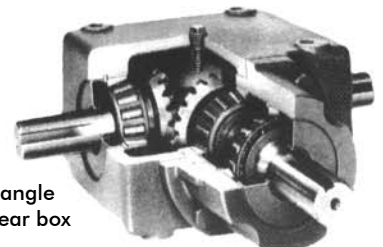

Right-angle bevel gear box